

**W.B.VASANTHA KANDASAMY
FLORENTIN SMARANDACHE**

**GRUPOIDS
OF TYPE I AND
TYPE II USING $[0, n)$**

Groupoids of Type I and II using $[0, n)$

**W. B. Vasantha Kandasamy
Florentin Smarandache**

**Educational Publisher Inc.
Ohio
2014**

This book can be ordered from:

Education Publisher Inc.
1313 Chesapeake Ave.
Columbus, Ohio 43212,
USA
Toll Free: 1-866-880-5373

Copyright 2014 by *Educational Publisher Inc.* and the *Authors*

Peer reviewers:

Said Broumi, University Hassan II Mohammedia, Hay El Baraka Ben
M'sik, Casablanca B.P. 7951, Morocco
Prof. Stefan Vladutescu, University of Craiova, Romania.
Maikel Leyva-Vázquez, Universidad de las Ciencias Informáticas,
La Habana, Cuba.
Mumtaz Ali, Quaid-i-Azam University, Islamabad, 44000, Pakistan.

Many books can be downloaded from the following
Digital Library of Science:
<http://www.gallup.unm.edu/eBooks-otherformats.htm>

ISBN-13: 978-1-59973-273-2
EAN: 9781599732732

Printed in the United States of America

CONTENTS

Preface	5
Chapter One INTRODUCTION	7
Chapter Two SPECIAL INTERVAL GROUPOIDS OF TYPE I USING $[0, n)$	9
Chapter Three SPECIAL INTERVAL GROUPOIDS OF TYPE II USING $[0, n)$	45

Chapter Four	
NON ASSOCIATIVE RINGS AND SEMIRINGS USING THE ALGEBRAIC STRUCTURES BUILT ON $[0, N)$	97
FURTHER READING	173
INDEX	177
ABOUT THE AUTHORS	178

PREFACE

Study of algebraic structures built using $[0, n)$ happens to be one of an interesting and innovative research. Here in this book authors define non associative algebraic structures using the interval $[0, n)$.

Here we define two types of groupoids using $[0, n)$ both of them are of infinite order.

It is an open conjecture to find whether these new class of groupoids satisfy any of the special identities like Moufang identity or Bol identity or Bruck identity or so on. We know on $[0, n)$ we cannot build rings only pseudo rings, however in this book we use these type I and type II groupoids to build non associative rings and semirings. Several interesting results are derived and some open problems are suggested.

We wish to acknowledge Dr. K Kandasamy for his sustained support and encouragement in the writing of this book.

W.B.VASANTHA KANDASAMY
FLORENTIN SMARANDACHE

Chapter One

INTRODUCTION

In this book the authors have constructed non associative algebraic structures like groupoids of type I and type II and non associative semirings and rings using the interval $[0, n)$. This study is new and innovative leading to several new non associative algebraic structures.

Using $[0, n)$ we are in a position to build infinite number of groupoids all of infinite order. Thus we have a natural way of constructing infinite order groupoids. These groupoids can be commutative or non commutative but they are always non associative.

We build type I groupoids and type II groupoids. For groupoids in general refer [18, 20-1, 23, 31].

These groupoids behave in a very unusual way for it is an open conjecture to find type II groupoids to satisfy any of the special identities.

Using these type I and type II groupoids we build type I and type II rings and semirings which are non associative.

Study of these new algebraic structures is innovative and interesting. We have derived several interesting features about these structures.

Using $[0, n)$; authors have constructed associative algebraic structures like semigroups, groups, semirings and special interval pseudo rings [42].

Infact we are not in a position to get a ring or a field structure as the distributive laws $a(b + c) = ab + ac$ is not in general true for $a, b, c \in [0, n)$.

Several open conjectures are given in this book.

Chapter Two

SPECIAL INTERVAL GROUPOIDS OF TYPE I USING $[0, n)$

In this chapter for the first time we introduce the new class of non associative groupoids of infinite order using the real interval $[0, n)$; $n < \infty$. Such study is very new and this gives infinite number of infinite order groupoids by using only interval $[0, n)$, ($n < \infty$).

All of them are distinct. Whether they can satisfy any of the special identity happens to be an open problem. However in Z_n when we constructed groupoids several of them satisfied many special identities. But this is not true in general when $[0, n)$ is used instead of Z_n .

We define special interval groupoids of type I in this chapter and analyse several interesting properties about them.

DEFINITION 2.1: *Let $\{G, *\} = \{[0, n), n < \infty, a * b = at + bs \pmod{n}$ for all $a, b \in [0, n)$; and $s, t \in Z_n\}$. $(G, *)$ is defined as a special interval groupoid of type I of infinite order.*

Example 2.1: Let $\{G, *\} = \{[0, 7), (3, 4), *\}$ be the special interval groupoid of infinite order of type I.

Example 2.2: Let $\{G, *\} = \{[0, 12), *, (3, 7)\}$ be the special interval groupoid of type I and of infinite order.

Example 2.3: Let $\{G, *\} = \{[0, 16), *, (11, 7)\}$ be the special interval groupoid of type I of infinite order.

Example 2.4: Let $\{G, *\} = \{[0, 43), *, (2, 16)\}$ be the special interval groupoid of type I of infinite order.

Example 2.5: Let $\{G, *\} = \{[0, 25), *, (7, 18)\}$ be the special interval groupoid of type I of infinite order.

We have seen some examples of special interval groupoids of type I. All these groupoids are of infinite order.

Can we have special interval subgroupoids of type I of finite order?

The answer is yes. We will first give examples of them.

Example 2.6: Let $\{G, *\} = \{[0, 9), *, (3, 2)\}$ be the special interval groupoid of type I. Clearly $H = \{Z_9, *, (3, 2)\} \subseteq \{G, *\}$ is a special interval subgroupoid of order 9.

Likewise $K = \{0, 1, 0.5, 2.5, 2, 3.5, 3, \dots, 8, 8.5\} \subseteq [0, 9), *, (3, 2) \subseteq \{G, *\}$ is also a special interval subgroupoid of finite order.

$$\begin{aligned}
 \text{Let } a = 3.5 \text{ and } b = 7.5 \in K. \\
 a * b &= 3.5 * 7.5 \\
 &= 3(3.5) + 3(7.5) \\
 &= 10.5 + 15.0 \pmod{9} \\
 &= 25.5 \pmod{9} \\
 &= 7.5 \pmod{9} \text{ is in } K.
 \end{aligned}$$

We see order of K is finite.

Let $T = \{ \{0, 0.1, 0.2, 0.3, \dots, 0.9, 1, 1.1, 1.2, \dots, 8, 8.1, 8.2, \dots, 8.9\} \subseteq [0, 9), * \} \subseteq \{G, * \}$ be a special interval subgroupoid of finite order.

$$\begin{aligned} \text{Let } x = 3.5 \text{ and } y = 7.6 \in T, x * y &= 3.5 * 7.6 \\ &= 3(3.5) + 2(7.6) \pmod{9} \\ &= 10.5 + 15.2 \pmod{9} \\ &= 25.7 \pmod{9} \\ &= 7.7 \pmod{9} \in T. \end{aligned}$$

We further see $(G, *)$ is not commutative.

Now let $x = 3.21$ and $y = 6.105 \in (G, *)$.

$$\begin{aligned} \text{Consider } x * y &= 3.21 * 6.105 \\ &= 3.21 \times 3 + 6.105 \times 2 \pmod{9} \\ &= 9.63 + 12.210 \pmod{9} \\ &= 21.840 \pmod{9} \\ &= 3.840 \pmod{9} \quad \dots \quad \text{I} \end{aligned}$$

$$\begin{aligned} \text{Now } y * x &= 6.105 * 3.21 \\ &= 6.105 \times 3 + 3.21 \times 2 \\ &= 18.315 + 6.42 \pmod{9} \\ &= 24.735 \pmod{9} \\ &= 6.735 \pmod{9} \quad \dots \quad \text{II} \end{aligned}$$

Clearly I and II are not equal. Hence $(G, *)$ is a non commutative groupoid of type I.

It is easily verified $(G, *)$ is a non associative groupoid.

For let $x = 3.1, y = 2$ and $z = 5.6 \in (G, *)$;

$$\begin{aligned} (x * y) * z &= (3.1 * 2) * (5.6) \pmod{9} \\ &= (3.1 \times 3 + 2 \times 2) * 5.6 \\ &= (9.3 + 4) * 5.6 \\ &= 4.3 * 5.6 \\ &= 4.3 \times 3 + 5.6 \times 2 \\ &= 12.9 + 11.2 \\ &= 3.9 + 2.2 \\ &= 6.1 \pmod{9} \quad \dots \quad \text{I} \end{aligned}$$

Consider

$$\begin{aligned}
 x * (y * z) &= 3.1 * (2 * 5.6) \\
 &= 3.1 * (3 \times 2 + 5.6 \times 2) \\
 &= 3.1 * (6 + 11.2) \\
 &= (3.1 * 17.2) \pmod{9} \\
 &= (3.1 * 8.2) \pmod{9} \\
 &= 3.1 \times 3 + 8.2 \times 2 \\
 &= 9.3 + 16.4 \\
 &= 0.3 + 7.4 \\
 &= 7.7 \pmod{9} \quad \dots \text{ II}
 \end{aligned}$$

I and II are distinct hence $(x * y) * z \neq x * (y * z)$ in general for $x, y, z \in (G, *)$.

Example 2.7: Let $\{G, *\} = \{[0, 11), *, (3, 8)\}$ be the special interval groupoid of type I.

$\{H, *\} = \{Z_{11}, *, (3, 8)\} \subseteq \{G, *\}$ is a special interval subgroupoid of type I finite order.

$\{K, *\} = \{\{0, 0.5, 1.0, 1.5, 2, \dots, 10.5\} \subseteq [0, 11), *, (3, 8)\} \subseteq \{G, *\}$ be the special interval subgroupoid of type I of finite order.

$\{T, *\} = \{\{0, 0.1, 0.2, \dots, 0.9, 1, 1.1, \dots, 1.9, 2, \dots, 10.1, 10.2, 10.3, \dots, 10.9\} \subseteq [0, 11), *, (3, 8)\} \subseteq \{G, *\}$ be a special interval subgroupoid of finite order of type I.

However $\{G, *\}$ is a special interval groupoid of infinite order of type I.

Example 2.8: Let $(G, *) = \{[0, 18), *, (3, 6)\}$ be the special interval subgroupoid of infinite order of type I. $(G, *)$ has zero divisors. For take let $x = 6$ and $y = 3 \in (G, *)$.

$x * y = 6 * 3 = 3 \times 6 + 6 \times 3 \equiv 0 \pmod{18}$ $(G, *)$ is a zero divisor.

Let $x = 6$ and $9 = y \in (G, *)$; $x * y = (6 * 9) = 6 \times 3 + 9 \times 6 = 18 + 54 = 0 \pmod{18}$ is again a zero divisor of $(G, *)$.

Example 2.9: Let $(G, *) = \{[0, 12), *, (3, 4)\}$ be a special interval groupoid of type I of infinite order.

Let $x = 4$ and $y = 6 \in (G, *)$. $x * y = 4 \times 3 + 6 + 4 = 0 \pmod{12}$ is a zero divisor in $(G, *)$. Let $x = 4$ and $y = 4 \in (G, *)$; $x * y = 3x + 4y = 3 \times 4 + 4 \times 4 = 4$ is an idempotent in $(G, *)$. $(G, *)$ has idempotents and zero divisors. $(G, *)$ has special interval subgroupoids of finite order and infinite order.

Example 2.10: Let $(G, *) = \{[0, 16), *, (4, 8)\}$ be a special interval groupoid of infinite order of type I.

$x = 4$ and $y = 6 \in (G, *)$ is such that $x * y = 4 * 6 = 4 \times 4 + 6 \times 8 \equiv 0 \pmod{16}$ is a zero divisor in $(G, *)$.

Likewise we can have several zero divisors in $(G, *)$.

$P_1 = \{Z_6, *, (4, 8)\} \subseteq (G, *)$ is also a special interval type I subgroupoid of finite order.

$P_2 = \{\{0, 0.5, 1, 1.5, \dots, 15.5\} \subseteq [0, 16), *, (4, 8)\} \subseteq (G, *)$ is a special interval type I subgroupoid of finite order.

$4 \in (G, *)$ is such that $4 * 4 = 4 \times 4 + 8 \times 4 \equiv 0 \pmod{16}$ is a nilpotent element of order two in $(G, *)$.

Thus $(G, *)$ has idempotents, zero divisors and nilpotents.

$P_3 = \{\{0, 0.1, 0.2, \dots, 0.9, 1, 1.1, \dots, 1.9, \dots, 15, 15.1, 15.2, \dots, 15.9\}, *, (4, 8)\} \subseteq (G, *)$ is a special interval subgroupoid of finite order of type I.

Example 2.11: Let $(G, *) = \{[0, 19), *, (0, 6)\}$ be the special interval type I groupoid of infinite order.

We see for every $x \in (G, *)$ is such that $x * 0 = 0$ and $0 * x = 6x \pmod{19}$. So even zero is only a one sided zero divisor in $(G, *)$.

$(G, *)$ has no other zero divisors for $x * y \neq 0$, if $x, y \in G \setminus \{0\}$.

Study of zero divisors, units, idempotents and nilpotents in $(G, *)$ where $[0, n)$ is used and n -prime is left as an open conjecture.

Example 2.12: Let $(G, *) = \{[0, 3), *, (2, 1)\}$ be the S-special interval groupoid of type I of infinite order.

Let $x = y = 2 \in G$,
 $x * y = 2 * 2 = 2 \times 2 + 2 \times 1 \pmod{3} = 4 + 2 \equiv 0 \pmod{3}$.

2 is a nilpotent element of order two.

$1 \in (G, *)$ is also nilpotent of order two for
 $1 * 1 = 2 \times 1 + 1 \times 1 = 3 \equiv 0 \pmod{3}$.

Further $x = 1.4$ and $y = 0.2 \in G$ is such that
 $x * y = 1.4 \times 2 + 0.2 \times 1 = 2.8 + 0.2 \equiv 0 \pmod{3}$ is a one side zero divisor in G .

Let $x \in G$, we have unique $y \in G$ such that
 $x * 2 + 1 * y = 0 \pmod{3}$.

For if $x = 2.1037$ then $y = 1.7926 \in G$ is such that
 $x * y = 2.1037 \times 2 + 1.7926$
 $= 4.2074 + 1.7926 = 6.0000 \equiv 0 \pmod{3}$
 is only one sided zero divisor.

For consider
 $y * x = 1.7926 \times 2 + 2.1037$
 $= 3.5852 + 2.1037 = 2.6889 \pmod{3}$
 is not a zero divisor.

However $x * y = 0$ does not in general imply $y * x = 0$, that is, $y * x \neq 0$.

The interesting problem is find right zero divisors which are also left zero divisors.

Example 2.13: Let $(G, *) = \{[0, 21], *, (3, 7)\}$ be a special interval groupoid of type I of infinite order.

We see if $x = 7$ and $y = 3$ then
 $x * y = 7 * 3 = 7 \times 3 + 3 \times 7 = 0 \pmod{21}$.

$$\begin{aligned} \text{Let } x = 14 \text{ and } y = 3 \in (G, *) \\ x * y = 14 * 3 \\ = 4 \times 3 + 3 \times 7 = 0 \pmod{21}. \end{aligned}$$

Consider $3 \times 7 = 3 \times 3 + 7 \times 7 = 9 + 49 = 58 \neq 0 \pmod{21}$.

So $y = 3$ and $x = 7$ is only a zero divisor and not a two sided zero divisor.

Example 2.14: Let $(G, *) = \{[0, 27], (1, 26), *\}$ be a special interval groupoid of type I of infinite order.

Let $x = 2$ and $y = 2 \in (G, *)$;
 $x * y = 1 \times 2 + 26 \times 2 = 2 + 52 = 54 \equiv 0 \pmod{27}$.

Similarly $y * x = 0$. Thus $x, y \in (G, *)$ is such that it is zero divisor infact the nilpotent of order two.

Every $x \in Z_{27}$ is such that it is nilpotent of order two.

Example 2.15: Let $\{G, *\} = \{[0, 6], *, (5, 1)\}$ be a special interval groupoid of infinite order of type I. Every element $x \in Z_6$ is a nilpotent element of order two.

Apart from this $(G, *)$ has zero divisors.

Example 2.16: Let $(G, *) = \{[0, 23), *, (22, 1)\}$ be the special interval groupoid of type I of infinite order.

Clearly $(G, *)$ is a non commutative groupoid.

Every $x \in Z_{23}$ in $(G, *)$ is such that $x * x \equiv 0 \pmod{23}$; thus every element is nilpotent of order two in $(G, *)$.

In view of all these we give the following theorem the proof of which is left as an exercise to the reader.

THEOREM 2.1: Let $(G, *) = \{[0, n), *, (n-1, 1)\}$ be the special interval groupoid of type I of infinite order. $(G, *)$ has atleast $(n-1)$ nilpotent elements of order two.

Proof: We just hint for every $x \in Z_n$ is such that $x * x = (n-1)x + x = nx \equiv 0 \pmod{n}$ is nilpotent of order two.

Corollary: Let $\{G, *\} = \{[0, n), *, (1, n-1)\}$ be the special interval groupoid of type I of infinite order. Every $x \in Z_n$ is a nilpotent element of order two in G .

Example 2.17: Let $(G, *) = \{[0, 10), *, (9, 1)\}$ be the special interval groupoid of type I. $(G, *)$ is of infinite order.

Let $x \in (G, *)$; there exists a unique y such that $x * y \equiv 0 \pmod{10}$.

However $y * x \neq 0$. Thus we have one sided zero divisors. Let $x = 4.3 \in [0, 10)$;

$$\begin{aligned} x * y &= 4.3 \times 9 + 1 \times y \\ &= 38.7 + y \equiv 0 \pmod{10} \text{ implies } y = 1.3 \in [0, 10). \end{aligned}$$

Thus for every $x \in [0, 10)$ we have a $y \in [0, 10)$ such that $x * y = 0$, however $y * x \neq 0$.

Example 2.18: Let $(G, *) = \{[0, 27), *, (26, 1)\}$ be the special interval groupoid of type I of infinite order.

Every $x \in Z_{27}$ is nilpotent of order two, but $(G, *)$ has right zero divisors which are not left zero divisors.

For if $x = 1.2 \in (G, *)$ we have a $y \in (G, *)$ such that

$$x * y = 1.2 * y = 1.2 \times 26 + y = 0 \pmod{27} = 31.2 + y \equiv 0 \pmod{27}.$$

This implies $y = 22.8$ is such that $x * y \equiv 0 \pmod{27}$.

$$\begin{aligned} \text{Clearly } y * x &= 22.8 * 1.2 \\ &= 22.8 \times 26 + 1.2 \\ &= 0 \pmod{27}. \end{aligned}$$

Thus $x * y = 0 = y * x$ is a zero divisor.

Now the problem lies in the fact if given x , does the y in $(G, *)$ such that $x * y = y * x = 0$ where the elements are from $(G, *) = \{[0, n], *, (n-1, 1)\}$.

However we see $x * y \neq y * x$ even if $(G, *) = \{[0, n], *, (n-1, 1)\}$.

For take $(G, *) = \{[0, 8], *, (7, 1)\}$ to be the special interval groupoid of type I of infinite order. Let $x = 0.8$

$$\begin{aligned} x * y &= 7 \times 0.8 + y \equiv 0 \pmod{8} \\ &= 5.6 + y \equiv 0 \pmod{8}. \end{aligned}$$

This leads to $y = 2.4$.

$$\begin{aligned} \text{Thus } x * y &= 0.8 * 2.4 \\ &= 7 \times 0.8 + 2.4 \times 1 \\ &= 5.6 + 2.4 \\ &= 8 \equiv 0 \pmod{8}. \end{aligned}$$

$$\text{Thus } x * y = 0 \qquad \dots \qquad \text{I}$$

$$\begin{aligned} \text{Consider } y * x &= 2.4 * 0.8 \\ &= 2.4 \times 7 + 0.8 \times 1 \\ &= 16.8 + 0.8 \\ &= 0.8 + 0.8 = 1.6 \neq 0 \pmod{8}. \end{aligned}$$

Thus $x * y = 0$ but $y * x \neq 0$. Hence we cannot in general say if $(G, *) = \{[0, n), *, (n-1, 1) \text{ (or } (1, n-1))\}$; $x * y = 0 \pmod{n}$ does not imply $y * x = 0 \pmod{n}$.

In some special cases it may so happen $x * y = 0$ imply $y * x = 0$.

Thus it is left as an open problem to find the condition on n or on x and y so that $x * y = 0$ imply $y * x = 0$ for x, y in $(G, *) = \{[0, n), *, (n-1, 1) \text{ (or } (1, n-1))\}$.

Example 2.19: Consider $(G, *) = \{[0, 16), *, (15, 1)\}$ to be the special interval groupoid of infinite order of type I.

$$\begin{aligned} \text{Let } x &= 0.8 \text{ and } y \in (G, *); \\ x * y &= 15 \times 0.8 + y \equiv 0 \pmod{16}. \end{aligned}$$

This gives $y = 4$ so that $x * y \equiv 0 \pmod{16}$.

$$\begin{aligned} \text{But however } y * x &= 4 * 0.8 \\ &= 15 \times 4 + 0.8 \times 1 \\ &= 60 + 0.8 = 60.8 \neq 0 \pmod{16}. \end{aligned}$$

Thus $x * y \neq y * x$ and $y * x$ is not a zero divisor only $x * y$ is a zero divisor.

Example 2.20: Let $(G, *) = \{[0, 15), *, (14, 1)\}$ be the special interval groupoid of type I of infinite order.

$$\begin{aligned} \text{Let } x &= 0.8 \in (G, *) \text{ we can find } y \text{ in } [0, 15) \text{ so that} \\ x * y &= 0.8 \times 14 + y \equiv 0 \pmod{15} \\ &= 11.2 + y \equiv 0 \pmod{15} \text{ implies } y = 3.8. \end{aligned}$$

$$\begin{aligned} x * y &= 0.8 * 3.8 \\ &= 0.8 \times 14 + 3.8 \times 1 \\ &= 11.2 + 3.8 \\ &= 15 \equiv 0 \pmod{15}. \end{aligned}$$

$$\begin{aligned} \text{Consider } y * x &= 3.8 * 0.8 \\ &= 3.8 \times 14 + 0.8 \times 1 \\ &\neq 0 \pmod{15}. \end{aligned}$$

Thus only $x * y$ is a zero divisor but $y * x \neq 0$.

Example 2.21: Let $(G, *) = \{[0, 24), (8, 4), *\}$ be a special interval groupoid of infinite order of type I.

$\{G, *\}$ has also finite subgroupoids.

$$P_1 = \{Z_{24}, *, (8, 4)\} \subseteq \{G, *\},$$

$$P_2 = \{\{0, 0.5, 1, 1.5, 2, \dots, 23, 23.5\} \subseteq [0, 24), *, (8, 4)\} \subseteq \{G, *\},$$

$$P_3 = \{\{0, 0.2, .0.4, 0.6, 0.8, 1, 1.2, 1.4, \dots, 23, 23.2, 23.4, \dots, 23.8\} \subseteq [0, 24), *, (8, 4)\} \subseteq \{G, *\} \text{ and}$$

$P_4 = \{\{0, 0.1, 0.2, \dots, 0.9, 1, 1.1, 1.2, \dots, 1.9, 2, 2.1, \dots, 23, 23.1, \dots, 23.9\} \subseteq [0, 24), *, (8, 4)\} \subseteq \{G, *\}$ are four special interval subgroupoids of finite order.

$$\begin{aligned} \text{Let } x = 3 \text{ and } y = 6 \in (G, *) \text{ we see} \\ x * y &= 3 * 6 = 3 \times 8 + 6 \times 4 = 0 \pmod{24}; \text{ but} \\ y * x &= 6 * 4 = 6 \times 8 + 4 \times 3 = 12 \pmod{24}. \end{aligned}$$

Thus $x * y = 0$ but $y * x \neq 0$ hence x is only a one sided zero divisor and not a two sided zero divisor.

But $x = 6 \in (G, *)$ is a nilpotent element of order two.

Similarly $y = 12$ is also a nilpotent element of order two.
Also $z = 18 \in (G, \times)$ is a nilpotent element of order two.

Consider $x = 1.2 \in (G, *)$.

Suppose $x * y = 0$ what is that y for this $x = 1.2$

$$\begin{aligned}
 x * y &= 1.2 * y \\
 &= 8 \times 1.2 + 4y \\
 &= 9.6 + 4 \times 3.6 \\
 &= 9.6 + 14.4 \\
 &= 24.0 \pmod{24}.
 \end{aligned}$$

Thus $y = 3.6$ leads to $x * y = 0$.

$$\begin{aligned}
 \text{Consider } y * x &= 3.6 * 1.2 \\
 &= 3.6 \times 8 + 1.2 \times 4 \\
 &= 2.88 + 4.8 \\
 &= 88 \pmod{24}
 \end{aligned}$$

$y * x \neq 0$. Hence x is only a one sided zero divisor.

If $x = 12$ and $y = 6 \in G$ then $x * y = y * x = 0 \pmod{24}$. Thus x is a zero divisor of y and y is a zero divisor of x . However both x and y are nilpotents of order two. We see $(G, *)$ has both nilpotents, one sided zero divisors and zero divisors.

Several questions remain open.

Can we say in $(G, *) = \{[0, n), *, (t, s); n \text{ non prime } t \text{ and } s \text{ divisors of } n\}$; every element is a one sided zero divisor?

THEOREM 2.2: *Let $\{G, *\} = \{[0, n), *, (s, t)\}$ be the special interval groupoid of type I. If $x * y = 0$ and $y * x \neq 0$ in $\{G, *\}$ then $y * x = 0$ in the groupoid $\{G', *\} = \{[0, n), *, (t, s)\}$ of type I.*

Proof is direct and hence left as an exercise to the reader.

Corollary: If $x \in \{G, *\}$ is nilpotent then $x \in \{G', *\}$ is also nilpotent, $\{G', *\}$ as in Theorem 2.2.

Example 2.22: Let $(G, *) = \{[0, 42), *, (17, 13)\}$ be the special interval groupoid of infinite order of type I.

$M_1 = \{Z_{42}, *, (17, 13)\} \subseteq (G, *)$ is a special interval subgroupoid of G of finite order of type I.

$M_2 = \{\{0, 0.5, 1, 1.5, 2, 2.5, \dots, 41, 41.5\} \subseteq [0, 42), *, (17, 13)\} \subseteq (G, *)$ is also a special interval subgroupoid of G of finite order. All these groupoids of type I are of infinite order and none of them is commutative.

We now give examples of commutative special interval groupoids of type I of infinite order.

Example 2.23: Let $\{G, *\} = \{[0, 9), *, (4, 4)\}$ be the S-special interval groupoid of type I. Clearly $(G, *)$ is commutative.

For if $2, 3 \in (G, *)$,

$$2 * 3 = 4 \times 2 + 4.3 \pmod{9} = 8 + 12 \pmod{9} = 2 \quad \dots \quad \text{I}$$

$$\text{Now } 3 * 2 = 3 \times 4 + 2 \times 4 = 12 + 8 \pmod{9} = 2 \quad \dots \quad \text{II}$$

We can show $(G, *)$ is commutative but is not associative.

For take $x = 4, y = 3$ and $z = 1.2 \in (G, *)$;

$$\begin{aligned} (x * y) * z &= (4 * 3) * 1.2 \\ &= (4 \times 4 + 3 \times 4) * 1.2 \\ &= (16 + 12) * 1.2 \pmod{9} \\ &= 1 * 1.2 \\ &= 4 \times 1 + 1.2 \times 4 \\ &= 4 + 4.8 \\ &= 8.8 \quad \dots \quad \text{I} \end{aligned}$$

$$\begin{aligned} \text{Now } x * (y * z) &= 4 * (3 * 1.2) \\ &= 4 * [3 \times 4 + 4 \times 1.2] \\ &= 4 * (12 + 4.8) \pmod{9} \\ &= 4 * 7.8 \\ &= 4 \times 4 + 4 \times 7.8 \\ &= 16 + 31.2 \pmod{9} \\ &= 47.2 \pmod{9} \\ &= 2.2 \quad \dots \quad \text{II} \end{aligned}$$

Clearly I and II are distinct. Hence $(G, *)$ is a non commutative groupoid of type I of infinite order.

Example 2.24: Let $(G, *) = \{[0, 17), *, (5, 5)\}$ be the special interval groupoid of type I of infinite order.

Let $x = 3$ and $y = 4 \in (G, *)$.

$$\begin{aligned} x * y &= 3 * 4 \\ &= 3 \times 5 + 4 \times 5 \pmod{17} \\ &= 15 + 20 \pmod{17} \\ &= 1 \qquad \qquad \qquad \dots \quad \text{I} \end{aligned}$$

$$\begin{aligned} y * x &= 4 * 3 \\ &= 4 \times 5 + 3 \times 5 \\ &= 20 + 15 \\ &= 1 \qquad \qquad \qquad \dots \quad \text{II} \end{aligned}$$

$x * y = y * x$; so $(G, *)$ is the commutative special interval groupoid of infinite order of type I.

Let $x = 1.5, y = 2.1$ and $z = 5$ be as in $\{G, *\}$.

$$\begin{aligned} (x * y) * z &= (1.5 * 2.1) * z \\ &= (1.5 \times 4 + 2.1 \times 4) * z \\ &= (6 + 8.4) * z \\ &= 14.4 * z \\ &= 14.4 \times 4 + 5 \times 4 \\ &= 57.6 + 20 \pmod{17} \\ &= 77.6 \pmod{17} \\ &= 9.6 \qquad \qquad \qquad \dots \quad \text{I} \end{aligned}$$

$$\begin{aligned} x * (y * z) &= x * (2.1 * 5) \\ &= x * (2.1 \times 4 + 5 \times 4) \\ &= x * (8.4 + 20) \\ &= 1.5 * 11.4 \\ &= 1.5 \times 4 + 11.4 \times 4 \\ &= 6 + 45.6 \\ &= 51.6 \pmod{17} \\ &= 0.6 \qquad \qquad \qquad \dots \quad \text{II} \end{aligned}$$

Clearly I and II are distinct so $(G, *)$ is commutative but clearly a non associative special interval groupoid.

Example 2.25: Let $(G, *) = \{[0, 27], *, (11, 11)\}$ be the special interval groupoid of type I of infinite order.

Clearly $(G, *)$ is commutative and non associative.

Inview of all these we have the following theorem.

THEOREM 2.3: Let $(G, *) = \{[0, n], *, (t, t), t \in Z_n \setminus \{0, 1\}\}$ be the special interval groupoid of type I. $(G, *)$ is commutative and of infinite order but non associative.

The proof is left as an exercise to the reader.

Next we proceed onto describe S-special interval groupoids of type I.

Let $\{G, *\} = \{[0, n], *, (t, s)\}$ be a special interval groupoid of type I. $(t, s \in Z_n)$.

If $\{G, *\}$ contains a non empty subset P such that $\{P, *\}$ is a semigroup then $(G, *)$ is defined as a Smarandache special interval groupoid of type I.

We will give examples of S-special interval groupoid of type I.

Example 2.26: Let $\{G, *\} = \{[0, 6], *, (4, 5)\}$ be the special interval groupoid.

$(G, *)$ is a S-special interval groupoid as $P = \{0, 3\} \subseteq (G, *)$ is only a semigroup.

$$\begin{aligned} \text{For } 3 * 3 &= 4 \times 3 + 5 \times 3 \\ &= 3 \pmod{6} \\ \text{so } P = \{3\} &\text{ is a semigroup.} \end{aligned}$$

Example 2.27: Let $\{G, *\} = \{[0, 8), *, (2, 6)\}$ be the special interval groupoid of type I. $\{G, *\}$ is a S-special interval groupoid as $P = \{0, 4\} \subseteq \{G, *\}$ is a semigroup.

Example 2.28: Let $\{G, *\} = \{[0, 12), *, (1, 3)\}$ be the special interval groupoid of type I. $\{G, *\}$ is a S-special interval groupoid of type I.

Now we define all special properties related with special interval groupoids of type I.

Let $\{G, *\}$ be a S-special interval groupoid of type I. A Smarandache special left ideal A of the S-special groupoid $(G, *)$ satisfies the following conditions.

- (i) A is a Smarandache special subgroupoid of $\{G, *\}$.
- (ii) $x \in (G, *)$ and $a \in A$ then $xa \in A$.

Similarly we can define S-special right ideals.

A is a S-special ideal if $\{G, *\}$ is both a S-special right ideal as well as S-special left ideal of $(G, *)$.

A S-special subgroupoid V of $\{G, *\}$ is said to be S-seminormal special groupoid of $\{G, *\}$ if $aV = X$ for all $a \in \{G, *\}$.

$Va = Y$ for all $a \in G$ where either X or Y is a S-special subgroupoid of G but X and Y are both S-special subgroupoids.

We say $\{G, *\}$ is a S-special normal groupoid if $aV = X$ and $Va = Y$ for all $a \in \{G, *\}$ where both X and Y are Smarandache special subgroupoids of G .

We call two S-special subgroupoids H and P of type I to be Smarandache semiconjugate subgroupoids of G if

- (i) H and P are S-special subgroupoids of G .
- (ii) $H = xP$ or Px or

(iii) $P = xH$ or Hx for some $x \in G$.

We say the subgroupoids H and P of G are Smarandache conjugate subgroupoids of G if

- (i) H and P are Smarandache subgroupoids of G .
- (ii) $H = xP$ or Px and
- (iii) $P = xH$ or Hx .

We will describe this by some examples.

Example 2.29: Let $\{G, *\} = \{[0, 6), *, (4, 5)\}$ be a S-special interval groupoid of type I.

Let $A = \{1, 3, 5\} \subseteq \{G, *\}$ be a S-special interval subgroupoid.

Now $aA = A$ for all a in $T = \{Z_6, *, (4, 5)\}$, a S-groupoid of $(G, *)$.

But $Aa = \{0, 2, 4\} \subseteq T$ is not a S-subgroupoid of G .

Hence A is a weakly S-seminormal subgroupoid of $T \subseteq (G, *)$.

We see in case of S-special interval groupoids it is difficult to get the concept of S-seminormal subgroupoid of $\{G, *\} = \{[0, n), *, (t, s); t, s \in Z_n\}$ so only we are forced to get weakly S-seminormal subgroupoid concept.

The study of finding S-seminormality is a very difficult problem.

Now it is pertinent to keep on record that we cannot have the concept of S-normal groupoid in case of S-special interval groupoids.

We can have only the notion of weakly S-special interval normal groupoid.

Example 2.30: Let $\{G, *\} = \{[0, 8), *, (2, 6)\}$ be the S-special interval groupoid of type I.

$A = \{0, 2, 4, 6\} \subseteq \{Z_8, *, (2, 8)\} = G$ is a weakly Smarandache normal subgroupoid of G relative to T .

We see $aA = A$ for all $a \in T$ and $Aa = A$ for all $a \in T$.

Example 2.31: Let $\{G, *\} = \{[0, 8), *, (2, 4)\}$ be the S-special interval groupoid of type I. $T = \{Z_8, *, (2, 4)\}$ be a S-subgroupoid of $\{G, *\}$.

$P = \{0, 3, 2, 4, 6\}$ and $Q = \{0, 2, 4, 6\}$ are both S-special subgroupoids of $(G, *)$. $7P = Q$ so P and Q are weakly S-semiconjugate special subgroupoids of G .

Example 2.32: Let $(G, *) = \{[0, 12), (1, 3), *\}$ be the S-special groupoid of type I of infinite order. Consider $A_1 = \{0, 3, 6, 9\}$ and $A_2 = \{2, 5, 8, 11\}$ be any two S-special subgroupoids of G .

$A_1 = 3A_2 = \{0, 3, 6, 9\}$ and $A_2 = 2A_1 = 2\{0, 3, 6, 9\} = \{2, 5, 8, 11\}$.

We see A_1 and A_2 are S-groupoids. $T = \{Z_{12}, *, (1, 3)\} \subseteq \{G, *\}$. $\{G, *\}$ has S-special conjugate weakly subgroupoids.

We can have several such examples. This work of finding examples is left as an exercise to the reader.

Next we now proceed onto introduce the notion of Smarandache quasi special interval strong Moufang groupoid, Smarnadache quasi special interval Moufang groupoid, Smarandache quasi special interval strong Bol groupoid and so on.

We will define this and express this by some examples.

Let $\{G, *\} = \{[0, n), *, (t, u), t, u \in Z_n\}$ be the S-special interval groupoid of type I.

We say a S-special interval groupoid of type I to be a S-special quasi interval strong Moufang groupoid if $T = \{Z_n, *, (t, u)\} \subseteq \{G, *\}$ and if T is a S-strong Moufang groupoid.

We will illustrate this situation by some examples. Likewise we can define S-special quasi interval Moufang groupoid.

We will give examples of them.

Example 2.33: Let $\{G, *\} = \{[0, 10), *, (5, 6)\}$ be the Smarandache special interval groupoid of type I.

$T = \{Z_{10}, *, (5, 6)\} \subseteq \{G, *\}$ is a S-special interval subgroupoid of G.

We see T is a Smarandache strong Moufang groupoid as the Moufang identity;

$$(x * y) * (z * x) = [x * (y * z)] * x \text{ is true for } x, y, z \in (G, *).$$

$$\begin{aligned} (x * y) * (z * x) &= (5x * 6y) * (5z + 6x) \\ &= 5(5x + 6y) + 6(5z + 6x) \\ &= x. \end{aligned}$$

$$\begin{aligned} [x * (y * z)] * x &= [x * (5yy + 6z)] * x \\ &= [5x + 6(5y + 6z)] * x \\ &= (5x + 6z) * x \\ &= 5(5x + 6z) + 6x \\ &= 5x + 6x \\ &= x. \end{aligned}$$

We define $\{G, *\}$ to be a S-quasi special strong Moufang interval groupoid.

Thus a S-special interval groupoid of type I is a Smarandache strong special interval Moufang groupoid if

$T = \{Z_n, *, (t, s)\} \subseteq \{[0, n), *, (t, 0)\}$ is a S-strong Moufang groupoid.

$\{G, *\} = \{[0, 10), *, (5, 6)\}$ is a S-quasi special interval strong Moufang groupoid of type I. On similar lines we define the notion of S-quasi special interval Moufang groupoid of type I.

Let $\{G, *\} = \{[0, n), *, (t, u)\}$ be a S-special interval groupoid. We define $\{G, *\}$ to be a S-quasi special interval Moufang groupoid of type I if $\{Z_n, *, (t, u)\} \subseteq \{G, *\}$ is a S-Moufang groupoid.

To this end we give a few examples.

Example 2.34: Let $\{G, *\} = \{[0, 12), *, (3, 9)\}$ be the S-special interval groupoid of type I. Consider $T = \{Z_{12}, *, (3, 9)\}$, subgroupoid of $\{G, *\}$.

T has S-subgroupoids which satisfy Moufang identity and also S subgroupoids which do not satisfy the Moufang identity.

For $A_1 = \{0, 4, 8\}$ and $A_2 = \{0, 3, 6, 9\} \subseteq T$ are S-subgroupoids of T and A_2 does not satisfy the Moufang identity but A_1 satisfies the S-Moufang identity, so T is only a S-Moufang groupoid which is not a S-strong Moufang groupoid. Hence $\{G, *\}$ is a S-special quasi interval Moufang groupoid of type I which is not a S-special quasi interval strong Moufang groupoid of type I.

Now we can define the notion of S-special interval quasi Bol groupoid of type I and S-special interval quasi strong Bol groupoid of type I.

If in $\{G, *\} = \{[0, n), *, (t, u)\}$ the S-special interval subgroupoid. $T = \{Z_n, *, (t, u)\}$ is a Smarnadache strong Bol subgroupoid then we define $\{G, *\}$ to be a S-special interval quasi strong Bol groupoid.

If T is only a S-Bol subgroupoid of $\{G, *\}$; then we define $\{G, *\}$ to be a S-special interval quasi Bol groupoid.

Example 2.35: Let $\{G, *\} = \{[0, 12), *, (3, 4)\}$ be the S-special interval groupoid of type I. $\{G, *\}$ is of infinite order.

$\{Z_{12}, *, (3, 4)\} \subseteq \{G, *\}$ is a S-special interval groupoid which is a S-strong Bol groupoid.

Hence $\{G, *\}$ is a S-special quasi interval strong Bol groupoid of type I.

Consider the following example which is not a S-special quasi interval strong Bol groupoid. But only a S-quasi interval Bol groupoid of type I.

Example 2.36: Let $\{G, *\} = \{[0, 4), *, (2, 3)\}$ be the S-special interval groupoid of type I.

Let $A = \{0, 2\} \subseteq \{Z_4, *, (2, 3)\} \subseteq (G, *)$; satisfy the Bol identity, but all elements in Z_4 does not satisfy Bol identity hence $\{Z_4, *, (2, 3)\} \subseteq \{G, *\}$ is not a S-strong Bol groupoid only a S-Bol groupoid so $\{G, *\}$ is only a S-quasi special interval Bol groupoid of type I.

Example 2.37: Let $\{G, *\} = \{[0, 13), *, (7, 7)\}$ be the S-special interval groupoid of type I. $\{G, *\}$ is a S-special quasi strong interval idempotent groupoid of type I.

Example 2.38: Let $\{G, *\} = \{[0, 17), *, (9, 9)\}$ be the S-special quasi interval idempotent groupoid of type I.

Example 2.39: Let $\{G, *\} = \{[0, 12), *, (4, 9)\}$ be a S-special interval groupoid of type I. $\{G, *\}$ is a S-quasi special interval strong Moufang groupoid of type I.

Inview of this we give the following theorem.

THEOREM 2.4: Let $\{G, *\} = \{[0, n), *, (t, u), t, u \in Z_n \setminus \{0\}$ with $t + u \equiv 1 \pmod{n}\}$ be the S-special interval groupoid of type I. $\{G, *\}$ is a S-quasi special interval strong Moufang groupoid of type I if and only if $t^2 \equiv t \pmod{n}$ and $u^2 = u \pmod{n}$.

The proof is direct and follows from number theoretic properties.

Example 2.40: Let $\{G, *\} = \{[0, 6), *, (4, 3)\}$ be a S-special interval groupoid of type I. $\{G, *\}$ is a S-quasi special interval strong Bol groupoid of type I.

Example 2.41: Let $\{G, *\} = \{[0, 24), *, (16, 9)\}$ be a S-special interval groupoid of type I. $\{G, *\}$ is a S-quasi special interval strong P-groupoid of type I.

Example 2.42: Let $(G, *) = \{[0, 18), *, (9, 10)\}$ be a S-special interval groupoid of type I.

Clearly $\{G, *\}$ is a S-quasi special interval strong idempotent groupoid of type I.

Example 2.43: Let $\{G, *\} = \{[0, 15), *, (10, 6)\}$ be a S-special interval groupoid of type I. Clearly $\{G, *\}$ is a S-quasi special interval strong alternative groupoid.

Inview of all these we have the following theorem.

THEOREM 2.5: Let

$\{G, *\} = \{[0, n), *, (t, u); t, u \in Z_n, t + u = 1 \pmod{n}\}$ be a S-special interval groupoid of type I. $\{G, *\}$ is a S-special quasi interval

- (i) Strong Bol groupoid,
- (ii) Strong Moufang groupoid,
- (iii) Strong alternative groupoid,
- (iv) Strong idempotent groupoid and
- (v) Strong P-groupoid;

if and only if $t^2 \equiv t \pmod{n}$ and $u^2 \equiv u \pmod{n}$.

The proof is direct and hence left as an exercise to the reader.

However we see a single S-special interval groupoid of type I can simultaneously be a S-special quasi interval strong Bol, Moufang, alternative, P-groupoid and idempotent groupoid of type I.

Example 2.44: Let $(G, *) = \{[0, 12), *, (4, 0)\}$ be a S-special interval groupoid of type I. $(G, *)$ is a S-quasi special strong interval Moufang groupoid of type I.

Example 2.45: Let $\{G, *\} = \{[0, 18), *, (9, 0)\}$ be a S-special interval groupoid of type I. $\{G, *\}$ is a S-special interval quasi strong Moufang groupoid of type I. $\{G, *\}$ is a S-quasi special interval quasi strong Bol groupoid of type I of infinite order.

Example 2.46: Let $\{G, *\} = \{[0, 26), *, (13, 0)\}$ be a S-special interval groupoid of type I. $(G, *)$ is a S-special interval quasi strong P-groupoid of type I.

Example 2.47: Let $\{G, *\} = \{[0, 20), *, (5, 0)\}$ be a S-special interval groupoid of type I. $\{G, *\}$ is a S-quasi special interval quasi strong Bol groupoid of type I.

Example 2.48: Let $\{G, *\} = \{[0, 30), *, (0, 6)\}$ be a S-special interval groupoid of type I. $\{G, *\}$ is a S-quasi special interval strong alternative groupoid of type I.

Example 2.49: Let $\{G, *\} = \{[0, 36), *, (9, 0)\}$ be a S-special interval groupoid of type I. $\{G, *\}$ is a S-quasi special interval strong P-groupoid of type I.

Inview of this we have the following theorem.

THEOREM 2.6: Let $\{G, *\} = \{[0, n), *, (t, 0), t \in \mathbb{Z}_n\}$ be a S-special interval groupoid of type I. If $t * t \equiv t$ then $\{G, *\}$ is a S-

special quasi interval strong P-groupoid, strong alternative groupoid, strong idempotent groupoid, strong Bol groupoid, strong Moufang groupoid of type I.

Proof is direct hence left as an exercise.

Interested reader can study the associated properties and results of these interval groupoids of type I.

The study of S-special ideals is left as an exercise to the reader as it is a matter of routine.

Some related results are indicated for the reader without proof.

THEOREM 2.7: *Let $(G, *) = \{[0, n), *, (t, u), t, u \in Z_n\}$ be the S-special interval groupoid.*

*$\{G', *'\} = \{[0, n), *, (u, t), t, u \in Z_n\}$ be another special interval groupoid for the same t and u . P is a S-special left ideal of $\{G, *\}$ if and only if P is a S-special interval right ideal of $\{G', *'\}$.*

THEOREM 2.8: *Let $\{G, *\} = \{[0, n), *, (t, u), t, u \in Z_n\}$ be a S-special interval groupoid. $\{G, *\}$ is a S-special interval strong idempotent groupoid if and only if $t + u \equiv 1 \pmod{n}$.*

THEOREM 2.9: *Let*

*$\{G, *\} = \{[0, n), *, (t, u), t, u \in Z_n, t \text{ and } u \text{ primes } t + u = n\}$ be a S-special interval groupoid; then $\{G, *\}$ is a S-special interval simple groupoid.*

THEOREM 2.10: *Let*

*$\{G, *\} = \{[0, p), *, \left(\frac{p+1}{2}, \frac{p+1}{2}\right), p \text{ a prime}\}$ be a S-special interval strong idempotent groupoid.*

THEOREM 2.11: Let $\{G, *\} = \{[0, p), *, (t, t), t \in \mathbb{Z}_p\}$ be a special interval groupoid. $\{G, *\}$ is a commutative special interval groupoid.

THEOREM 2.12: Let $\{G, *\} = \{[0, n), *, (t, t)\}$ be a S -special interval groupoid. $\{G, *\}$ is a S -special interval strong P -groupoid.

THEOREM 2.13: Let $\{G, *\} = \{[0, n), *, (t, t), t \in \mathbb{Z}_n \setminus \{0, 1\}\}$ be a S -special interval groupoid; $\{G, *\}$ is not a S -strong alternative interval groupoid if p is a prime.

THEOREM 2.14: Let $\{G, *\} = \{[0, n), *, (t, t)\}$ ($t \in \mathbb{Z}_n \setminus \{1\}$) be a S -special interval groupoid (n not a prime); $\{G, *\}$ is a S -special interval strong alternative groupoid if and only if $t^2 \equiv t \pmod{n}$.

We suggest some problems for this chapter.

Problems:

1. Characterize those special interval groupoids of type I which are Bruck groupoids.
2. Enumerate some special features enjoyed by special interval groupoids of type I.
3. Can special interval groupoids of type I have special interval subgroupoids of infinite order? (Justify your claim).
4. Prove all special interval groupoids of type I need not always be a Smarandache special interval groupoids of type I.
5. Does the special interval groupoid $(G, *) = \{[0, 28), *, (11, 0)\}$ of type I satisfy any of the special identities?

6. Let $\{G, *\} = \{[0, 17), *, (3, 8)\}$ be a special interval groupoid of type I.

(i) Does $\{G, *\}$ satisfy any of the special identities?

(ii) Can $\{G, *\}$ have any special interval subgroupoid of type I of infinite order?

(iii) How many special interval subgroupoids in $(G, *)$ are of finite order?

(iv) Which of the special identities is satisfied by $(G, *)$?

(v) Is $(G, *)$ a S-groupoid of type I?

7. Let $\{G, *\} = \{[0, 23), (0, 20), *\}$ be a special interval groupoid of type I.

Study questions (i) to (v) of problem 6 for this $(G, *)$.

8. Let $\{G, *\} = \{[0, 29), *, (10, 10)\}$ be a special interval groupoid of type I.

Study questions (i) to (v) of problem 6 for this $\{G, *\}$.

9. Let $\{G, *\} = \{[0, 43), *, (12, 0)\}$ be a special interval groupoid of type I.

Study questions (i) to (v) of problem 6 for this $(G, *)$.

10. Let $\{G, *\} = \{[0, 42), *, (12, 0)\}$ be the special interval groupoid of type I.

Study questions (i) to (v) of problem 6 for this $(G, *)$.

11. Let $\{G, *\} = \{[0, 36), *, (13, 19)\}$ be the special interval groupoid of type I.

Study questions (i) to (v) of problem 6 for this $(G, *)$.

12. Let $\{G, *\} = \{[0, 45), *, (15, 0)\}$ be the special interval groupoid of type I.

Study questions (i) to (v) of problem 6 for this $(G, *)$.

13. Let $\{G, *\} = \{[0, 16), *, (8, 8)\}$ be the special interval groupoid of type I.

Study questions (i) to (v) of problem 6 for this $(G, *)$.

14. Let $\{G, *\} = \{[0, 32), *, (8, 16)\}$ be the special interval groupoid of type I.

Study questions (i) to (v) of problem 6 for this $(G, *)$.

15. Let $\{G, *\} = \{[0, 40), *, (16, 0)\}$ be the special interval groupoid of type I.

Study questions (i) to (v) of problem 6 for this $(G, *)$.

16. Let $\{G, *\} = \{[0, 23), *, (7, 7)\}$ be the special interval groupoid of type I.

Study questions (i) to (v) of problem 6 for this $(G, *)$.

17. Let $\{G, *\} = \{[0, 29), *, (10, 0)\}$ be the special interval groupoid of type I.

Study questions (i) to (v) of problem 6 for this $(G, *)$.

18. Let $\{G, *\} = \{[0, 120), *, (80, 40)\}$ be the special interval groupoid of type I.

Study questions (i) to (v) of problem 6 for this $(G, *)$.

19. Let $\{G, *\} = \{[0, 124), *, (2, 4)\}$ be the special interval groupoid of type I.

Study questions (i) to (v) of problem 6 for this $(G, *)$.

20. Let $\{G, *\} = \{[0, 139), *, (13, 13)\}$ be the special interval groupoid of type I.

Study questions (i) to (v) of problem 6 for this $(G, *)$.

21. Let $\{G, *\} = \{[0, 126), *, (7, 119)\}$ be the special interval groupoid of type I.

Study questions (i) to (v) of problem 6 for this $(G, *)$.

22. Give a class of S-strong interval Moufang groupoids of type I using the interval $[0, n)$.

23. Show all groupoids $\{G, *\}$ are not S-strong interval Moufang groupoids of type I.

24. Let $\{G, *\}$ be a special interval groupoid using $[0, n)$ of type I.

Show some of them are not S-strong interval Bol groupoids.

25. Characterize those special interval groupoids of type I which are S-special interval strong Bol groupoids of type I.

26. Let $\{G, *\} = \{[0, 25), *, (5, 0)\}$ be the special interval groupoid of type I.

Study questions (i) to (v) of problem 6 for this $(G, *)$.

27. Let $\{G, *\} = \{[0, 26), (12, 18), *\}$ be the special interval groupoid of type I.

Study questions (i) to (v) of problem 6 for this $(G, *)$.

28. Let $\{G, *\} = \{[0, 27), *, (9, 3)\}$ be the special interval groupoid of type I.

- (i) Does this $\{G, *\}$ satisfy any of the special S-strong identities?
 - (ii) Can $\{G, *\}$ be a S-groupoid?
 - (iii) Can $\{G, *\}$ have special interval subgroupoids of infinite order?
 - (iv) Find special S-right ideals which are special S-left ideals.
29. Let $\{G, *\} = \{[0, 24], *, (12, 8)\}$ be a special interval groupoid of type I.
- Study questions (i) to (iv) of problem 28 for this $\{G, *\}$.
30. Let $\{G, *\} = \{[0, 23], *, (11, 12)\}$ be a special interval groupoid of type I.
- Study questions (i) to (iv) of problem 28 for this $\{G, *\}$.
31. Characterize those special interval groupoids that are seminormal.
32. Characterize those special interval groupoids that are normal.
33. Characterize those special interval groupoids which are neither normal nor seminormal.
34. Give a class of S-special interval strong P-groupoids which are not S-special interval strong alternative groupoids.
35. Does there exist S-special interval strong P-groupoids which are not S-special interval strong Bol groupoid?
36. Does there exist a S-special interval strong P-groupoids which are not S-special interval strong Moufang groupoids?

37. Let $\{G, *\} = \{[0, 123), *, (101, 23)\}$ be a special interval groupoid of type I.

Study questions (i) to (iv) of problem 28 for this $\{G, *\}$.

38. Let $\{G, *\} = \{[0, 142), *, (16, 14)\}$ be a special interval groupoid of type I.

Study questions (i) to (iv) of problem 28 for this $\{G, *\}$.

39. Let $\{G, *\} = \{[0, 23), *, (10, 13)\}$ be a special interval groupoid of type I.

Study questions (i) to (iv) of problem 28 for this $\{G, *\}$.

40. Let

$\{G, *\} = \{(a_1, a_2, \dots, a_{10}) \mid a_i \in [0, 43), (9, 10), 1 \leq i \leq 10\}$ be a special interval groupoid of type I.

(i) Prove $\{G, *\}$ has zero divisors.

(ii) Find special subgroupoids of $\{G, *\}$.

(iii) Prove $\{G, *\}$ can have subgroupoids of infinite order.

(iv) Prove $\{G, *\}$ can also have subgroupoids of finite order.

(v) Find all right ideals of $\{G, *\}$ which are not left ideals.

41. Let

$\{G, *\} = \{(a_1, a_2, a_3, a_4) \mid a_i \in [0, 29), *, (0, 4), 1 \leq i \leq 4\}$ be a special interval groupoid of type I.

Study questions (i) to (v) of problem 40 for this $\{G, *\}$.

$$42. \text{ Let } \{G, *\} = \left\{ \left[\begin{array}{c} a_1 \\ a_2 \\ \vdots \\ a_{10} \end{array} \right] \middle| a_i \in [0, 45), *, (20, 25), 1 \leq i \leq 10 \right\}$$

be a special interval groupoid of type I.

Study questions (i) to (v) of problem 40 for this $\{G, *\}$.

$$43. \text{ Let } \{G, *\} = \left\{ \left[\begin{array}{c} a_1 \\ a_2 \\ \vdots \\ a_{12} \end{array} \right] \middle| a_i \in [0, 23), *, (10, 0), 1 \leq i \leq 12 \right\}$$

be a special interval groupoid of type I.

Study questions (i) to (v) of problem 40 for this $\{G, *\}$.

$$44. \text{ Let } \{G, *\} = \left\{ \left[\begin{array}{cccc} a_1 & a_2 & a_3 & a_4 \\ a_5 & a_6 & a_7 & a_8 \\ a_9 & a_{10} & a_{11} & a_{12} \\ a_{13} & a_{14} & a_{15} & a_{16} \end{array} \right] \middle| a_i \in [0, 43), *, \right.$$

$(23, 20), 1 \leq i \leq 16 \}$ be a special interval groupoid of type I.

Study questions (i) to (v) of problem 40 for this $\{G, *\}$.

$$45. \text{ Let } \{G, *\} = \left\{ \left[\begin{array}{ccccc} a_1 & a_2 & a_3 & a_4 & a_5 \\ a_6 & a_7 & a_8 & a_9 & a_{10} \\ a_{11} & a_{12} & a_{13} & a_{14} & a_{15} \\ a_{16} & a_{17} & a_{18} & a_{19} & a_{20} \\ a_{21} & a_{22} & a_{23} & a_{24} & a_{25} \end{array} \right] \mid a_i \in [0, 12), *, \right.$$

$(9, 4), 1 \leq i \leq 25\}$ be a special interval groupoid of type I.

Study questions (i) to (v) of problem 40 for this $\{G, *\}$.

Is $\{G, *\}$ a S-special interval groupoid?

$$46. \text{ Let } \{G, *\} = \left\{ \left[\begin{array}{ccc} a_1 & a_2 & a_3 \\ a_4 & a_5 & a_6 \\ \vdots & \vdots & \vdots \\ a_{28} & a_{29} & a_{30} \end{array} \right] \mid a_i \in [0, 18), *, (0, 9), \right.$$

$1 \leq i \leq 30\}$ be a special interval groupoid of type I.

Study questions (i) to (v) of problem 40 for this $\{G, *\}$.

Is $\{G, *\}$ a S-special interval groupoid?

$$47. \text{ Let } \{G, *\} = \left\{ \left(\begin{array}{cccc} a_1 & a_2 & \dots & a_{10} \\ a_{11} & a_{12} & \dots & a_{20} \\ a_{21} & a_{22} & \dots & a_{30} \end{array} \right) \mid a_i \in [0, 40), *, (0, 20), \right.$$

$1 \leq i \leq 30\}$ be a special interval groupoid of type I.

(i) Study questions (i) to (v) of problem 40 for this $\{G, *\}$.

(ii) Does $\{G, *\}$ satisfy any of the special identities?

(iii) Is $\{G, *\}$ a S-special interval groupoid?

48. Let $\{G, *\} = \{(a_1 | a_2 | a_3 a_4 a_5 | a_6 a_7 | a_8) | a_i \in [0, 10), *, (6, 5), 1 \leq i \leq 8\}$ be a special interval groupoid of type I.

(i) Study questions (i) to (v) of problem 40 for this $\{G, *\}$.

(ii) Is $\{G, *\}$ a S-special interval groupoid?

(iii) Does $\{G, *\}$ satisfy all S-special interval strong identities?

49. Let $\{G, *\} = \left\{ \left[\begin{array}{c} a_1 \\ a_2 \\ a_3 \\ a_4 \\ a_5 \\ a_6 \\ a_7 \\ a_8 \\ a_9 \\ a_{10} \\ a_{11} \\ a_{12} \\ a_{13} \\ a_{14} \end{array} \right] \mid a_i \in [0, 15), *, (6, 10), 1 \leq i \leq 14 \right\}$

be a special interval groupoid of type I.

- (i) Is $\{G, *\}$ a S-special interval groupoid?
- (ii) Does $\{G, *\}$ satisfy any of the special identities?
- (iii) Study questions (i) to (v) of problem 40 for this $\{G, *\}$.

50. Let $\{G, *\} = \{(a_1 \ a_2 \mid a_3 \mid a_4 \ a_5 \ a_6 \mid a_7) \mid a_i \in [0, 12), *, (9, 0), 1 \leq i \leq 7\}$ be a special interval groupoid of type I.

- (i) Study questions (i) to (v) of problem 40 for this $\{G, *\}$.
- (ii) Is $\{G, *\}$ a S-special interval groupoid?
- (iii) What are the S-strong special identities satisfied by the groupoid $\{G, *\}$?

51. Let $\{G, *\} = \left\{ \left[\begin{array}{c} a_1 \\ a_2 \\ a_3 \\ a_4 \\ a_5 \\ a_6 \\ a_7 \\ a_8 \\ a_9 \\ a_{10} \\ a_{11} \end{array} \right] \mid a_i \in [0, 10), *, (6, 5), 1 \leq i \leq 11 \right\}$

be a special interval groupoid of type I.

- (i) Study questions (i) to (v) of problem 40 for this $\{G, *\}$.
- (ii) Is $\{G, *\}$ a S-special interval groupoid?
- (iii) Will $\{G, *\}$ satisfy any of the S-special identities?

52. Let $\{G, *\} = \left\{ \begin{array}{c|c|c|c|c} a_1 & a_2 & a_3 & a_4 & a_5 \\ a_6 & a_7 & a_8 & a_9 & a_{10} \\ \hline a_{11} & a_{12} & a_{13} & a_{14} & a_{15} \\ a_{16} & a_{17} & a_{18} & a_{19} & a_{20} \\ a_{21} & a_{22} & a_{23} & a_{24} & a_{25} \\ \hline a_{26} & a_{27} & a_{28} & a_{29} & a_{30} \\ a_{31} & a_{32} & a_{33} & a_{34} & a_{35} \\ \hline a_{36} & a_{37} & a_{38} & a_{39} & a_{40} \end{array} \right\} \mid a_i \in [0, 12), *$

$(4, 9), 1 \leq i \leq 40\}$ be a special interval groupoid of type I.

- (i) Study questions (i) to (v) of problem 40 for this $\{G, *\}$.
- (ii) Is $\{G, *\}$ a S-special interval groupoid?
- (iii) Does $\{G, *\}$ satisfy any of the S-strong special identities?

53. Let $\{G, *\} = \left[\begin{array}{c|ccc|ccc|c} \mathbf{a}_1 & \mathbf{a}_2 & \mathbf{a}_3 & \mathbf{a}_4 & \mathbf{a}_5 & \mathbf{a}_6 & \mathbf{a}_7 \\ \hline \mathbf{a}_8 & \dots & \dots & \dots & \dots & \dots & \mathbf{a}_{14} \\ \hline \mathbf{a}_{15} & \dots & \dots & \dots & \dots & \dots & \mathbf{a}_{21} \\ \hline \mathbf{a}_{22} & \dots & \dots & \dots & \dots & \dots & \mathbf{a}_{28} \\ \hline \mathbf{a}_{29} & \dots & \dots & \dots & \dots & \dots & \mathbf{a}_{35} \\ \hline \mathbf{a}_{36} & \dots & \dots & \dots & \dots & \dots & \mathbf{a}_{42} \\ \hline \mathbf{a}_{43} & \dots & \dots & \dots & \dots & \dots & \mathbf{a}_{56} \\ \hline \mathbf{a}_{57} & \dots & \dots & \dots & \dots & \dots & \mathbf{a}_{63} \end{array} \right] \mathbf{a}_i \in$

$[0, 10), *, (6, 5), 1 \leq i \leq 63\}$ be a special interval groupoid of type I.

- (i) Study questions (i) to (v) of problem 40 for this $\{G, *\}$.
- (ii) Is $\{G, *\}$ a S-special interval groupoid?
- (iii) Does $\{G, *\}$ satisfy any of the S-strong special identities?

Chapter Three

SPECIAL INTERVAL GROUPOIDS OF TYPE II USING $[0, n)$

In this chapter we for the first time define yet another new class of special interval groupoids of type II using the intervals $[0, n)$; $n < \infty$. We define, describe and develop several interesting properties about them. These special interval groupoids of type II are all of infinite order.

DEFINITION 3.1: *Let*

$S = \{[0, n), *, (a, b) \text{ where } a, b \in [0, n) \setminus \mathbb{Z}_n\}$ *be the groupoid. We define S to be the special interval groupoid of type II.*

We will illustrate this situation by some examples.

Example 3.1: Let $S = \{[0, 3), *, (0.12, 1.051)\}$ be the special interval groupoid of type II. Clearly S is a non commutative groupoid of infinite order.

Let $a = 2$ and $b = 1.2 \in S$

$$a * b = 2 * 1.2$$

$$= 2 \times 0.12 + 1.2 \times 1.051$$

$$= 0.24 + 1.2612$$

$$= 1.5012 \in S$$

... I

$$\begin{aligned}
\text{Consider } b * a &= 1.2 * 2 \\
&= 1.2 \times 0.12 + 2 \times 1.051 \\
&= 0.144 + 2.102 \\
&= 2.246 \qquad \dots \text{ II is in S.}
\end{aligned}$$

Clearly I and II are not the same hence S is a non commutative groupoid of type II.

Let $a = 0.3$, $b = 0.07$ and $c = 0.02 \in S$.

Consider

$$\begin{aligned}
(a * b) * c &= (0.3 * 0.07) * 0.02 \\
&= (0.3 \times 0.12 + 0.07 \times 1.051) * 0.02 \\
&= (0.036 + 0.07357) * 0.02 \\
&= (0.10957 * 0.02) \\
&= 0.10957 \times 0.12 + 0.02 \times 1.051 \\
&= 0.0127884 + 0.0210200 \\
&= 0.0338084 \qquad \dots \text{ I}
\end{aligned}$$

$$\begin{aligned}
\text{Now } a * (b * c) &= 0.3 * (0.07 * 0.02) \\
&= 0.3 * (0.07 \times 0.12 + 0.02 \times 1.051) \\
&= 0.3 * (0.084 + 0.02102) \\
&= 0.3 * 0.10502 \\
&= 0.3 \times 0.07 + 0.10502 \times 1.051 \\
&= 0.021 + 0.01587602 \\
&= 0.03687602 \qquad \dots \text{ II}
\end{aligned}$$

I and II are distinct so $*$ on S in general is non associative. This is the way the operations are carried out on the special interval groupoids of type II.

Example 3.2: Let $S = \{[0, 10), *, (5.2, 0.4)\}$ be the special interval groupoid of type II. Clearly S is of infinite order. S is non commutative and non associative.

Example 3.3: Let $S = \{[0, 15), *, (10.21, 7.102)\}$ be the special interval groupoid of type II of infinite order.

Example 3.4: Let $S = \{[0, 8), *, (1.225, 1.225)\}$ be the special interval groupoid of type II of infinite order which is commutative.

Example 3.5: Let $S = \{[0, 7), *, (0.41, 0.41)\}$ be the special interval groupoid of type II.

Consider $x = 3.5$ and $y = 2.1$ in S .

$$\begin{aligned}x * y &= 3.5 * 2.1 \\ &= 0.41 \times 3.5 + 2.1 \times 0.41 \\ &= 1.435 + 0.861 \\ &= 2.296 \\ &= 2.296 \in S.\end{aligned}$$

Consider

$$\begin{aligned}y * x &= 2.1 * 3.5 \\ &= 0.41 \times 2.1 + 3.5 \times 0.41 \\ &= 0.861 + 1.435 \\ &= 2.296 \qquad \dots \quad I\end{aligned}$$

is in S .

Clearly $x * y = y * x$ for all $x, y \in S$. Thus S is a commutative special interval groupoid of type II.

Example 3.6: Let $S = \{[0, 27), *, (10.12, 9.31)\}$ be the special interval groupoid of type II. S is non commutative and is of infinite order.

Let $x = 3$ and $y = 5 \in S$.

$$\begin{aligned}x * y &= 3 * 5 \\ &= 3 \times 10.12 + 5 \times 9.31 \pmod{27} \\ &= 30.36 + 46.55 \pmod{27} \\ &= 76.91 \pmod{27} \\ &= 22.91 \in S.\end{aligned}$$

$$\begin{aligned}y * x &= 5 * 3 \\ &= 10.12 \times 5 + 9.31 \times 3 \\ &= 50.60 + 27.93 \\ &= 78.53 \pmod{27}\end{aligned}$$

$$= 24.53 \in S.$$

Clearly $x * y \neq y * x$ so S is a non commutative groupoid.

Let $x = 2, y = 1$ and $z = 4 \in S$.

$$\begin{aligned} (x * y) * z &= (2 * 1) * 4 \\ &= (2 \times 10.12 + 1 \times 9.31) * 4 \\ &= (20.24 + 9.31) * 4 \\ &= 29.55 * 4 \\ &= 2.55 * 4 \\ &= 10.12 \times 2.55 + 9.31 \times 4 \\ &= 25.806 + 37.24 \\ &= 63.046 \\ &= 9.046 \quad \dots \quad \text{I} \end{aligned}$$

$$\begin{aligned} x * (y * z) &= 2 * (1 * 4) \\ &= 2 * (1 \times 10.12 + 4 \times 9.31) \\ &= 2 * (10.21 + 37.24) \\ &= 2 * 47.36 \\ &= 2 * 20.36 \\ &= 2 \times 10.12 + 4 \times 20.36 \\ &= 20.24 + 81.44 \\ &= 101.68 \\ &= 20.68 \quad \dots \quad \text{II} \end{aligned}$$

Clearly I and II are distinct hence S is a non associative groupoid of infinite order.

Example 3.7: Let $S = \{[0, 128), * (0.1, 0.2)\}$ be the special interval groupoid of type II. S is non commutative and non associative of infinite order.

Example 3.8: Let $S = \{[0, 45), * (1.36, 0)\}$ be the special interval groupoid of type II. We see S has right zero divisors which are not left zero divisors and vice versa.

In fact for $x = a$ and $y = 0$ is a zero divisor only if $x \times 1.36 \equiv 0 \pmod{45}$ then $y * x = 0 \pmod{45}$ for all $x, y \in S$. Study in this direction is interesting.

Example 3.9: Let $S = \{[0, 12), * (0, 2.5)\}$ be the special interval groupoid of type II. S is non commutative.

$$\begin{aligned} \text{For } x = 5 \text{ and } y = 8 \text{ in } S \\ \text{we have } x * y &= 5 * 8 \\ &= 5 \times 0 + 8 \times 2.5 \\ &= 0 + 20.0 \\ &= 8 \pmod{12} \\ &\neq 0 \qquad \dots \quad \text{I} \end{aligned}$$

$$\begin{aligned} \text{But } y * x &= 8 * 5 \\ &= 8 \times 0 + 2.5 \times 5 \\ &= 0 + 12.5 \\ &= 0.5 \neq 0 \qquad \dots \quad \text{II} \end{aligned}$$

Clearly I and II are distinct so S is non commutative.

$$\begin{aligned} \text{Take } x = 0 \text{ and } y = 4.8 \text{ in } S. \\ x * y &= 0 * 4.8 \\ &= 0 \times 0 + 4.8 \times 2.5 \\ &= 0 + 12 \\ &\equiv 0 \pmod{12} \qquad \dots \quad \text{I} \end{aligned}$$

$$\begin{aligned} y * x &= 4.8 * 0 \\ &= 4.8 \times 0 + 0 \times 2.5 \\ &= 0 \pmod{12} \qquad \dots \quad \text{II} \end{aligned}$$

I and II are identical.

$x * y = y * x$ is a zero divisor.

Consider $x = 3$ and $y = 0 \in S$

$$\begin{aligned} x * y &= 3 \times 2.5 + 0 \times 0 \\ &= 7.5 \neq 0. \end{aligned}$$

$$\begin{aligned} y * x &= 0 \times 2.5 + 0 \times 3 \\ &= 0. \end{aligned}$$

Thus x and y is only a one sided zero divisor and is not a both sided zero divisor.

Let $x, y \in S$ where $x = 2.5$ and $y = 1.5$;

$$\begin{aligned}x * y &= 2.5 * 1.5 \\ &= 2.5 \times 2.5 + 1.5 \times 0 \\ &= 6.25 \neq 0\end{aligned}$$

$$\begin{aligned}\text{and } y * x &= 1.5 * 2.5 \\ &= 1.5 \times 2.5 + 2.5 \times 0 \\ &= 3.75 \neq 0.\end{aligned}$$

So S has pairs which are non commutative and are not zero divisors.

Example 3.10: Let $S = \{[0, 13), *, (0, 1.3)\}$ be the special interval groupoid of type I. S is non commutative and is of infinite order.

Let $x = 2$ and $y = 5 \in S$

$$\begin{aligned}x * y &= 2 \times 0 + 5 \times 1.3 \\ &= 0 + 6.5 \\ &= 6.5 \neq 0 \pmod{13} \text{ and}\end{aligned}$$

$$\begin{aligned}y * x &= 5 * 2 = 5 \times 0 + 2 \times 1.3 \\ &= 0 + 2.6 \\ &= 2.6 \neq 0 \pmod{13}.\end{aligned}$$

Clearly $x * y \neq y * x$, hence S is non commutative.

Let $x = 10$ and $y = 0$ be in S .

$$x * y = 10 * 0 = 0 \times 10 + 1.3 \times 0 = 0 \text{ and}$$

$$y * x = 0 * 10 = 0 \times 0 + 1.3 \times 10 = 13 \pmod{13} = 0.$$

Thus $x, y \in S$ is a zero divisor which is both right as well as left.

Let $x = 12$ and $y = 5 \in S$.

We see $x * y \neq y * x$ but is not a zero divisor.

We define quasi special interval groupoid of type II.

DEFINITION 3.2: *Let*

$S = \{[0, n), *, (a, b) \text{ where } a \in [0, n) \setminus Z_n \text{ and } b \in Z_n\}$ be the special interval groupoid. We call this special interval groupoid as quasi special interval groupoid of type II.

We will illustrate this situation by some examples.

Example 3.11: Let $S = \{[0, 16), *, (4, 2.315)\}$ be the quasi special interval groupoid of type II.

We see S is also of infinite order. S is always non commutative.

Example 3.12: Let $S = \{[0, 24), *, (0.3125, 8)\}$ be the quasi special interval groupoid of type II.

S is non commutative and of infinite order.

Example 3.13: Let $S = \{[0, 256), *, (16, 8.88)\}$ be the quasi special interval groupoid of type II.

S is non commutative and of infinite order.

Example 3.14: Let $S = \{[0, 125), *, (15, 2.25)\}$ be the quasi special interval groupoid of infinite order.

S is non commutative.

Example 3.15: Let $S = \{[0, 12), *, (1, 1.2)\}$ be the quasi special interval groupoid of infinite order.

Let $x = 5$ and $y = 10 \in S$.

$$\begin{aligned} x * y &= 5 * 10 \\ &= 5 * 1 + 10 \times 1.2 \\ &= 5 + 12 \\ &\equiv 5 \pmod{12} \quad \dots \text{ I} \end{aligned}$$

$$\begin{aligned} \text{Now } y * x &= 10 * 5 \\ &= 10 \times 1 + 5 \times 1.2 \\ &= 10 + 6.0 \\ &= 16 \pmod{12} \\ &= 4 \quad \dots \text{ II} \end{aligned}$$

Clearly I and II are distinct hence in general is a non commutative quasi special interval groupoid of infinite order.

THEOREM 3.1: *Let*

$S = \{[0, n), *, (a, b) \text{ where } a \in [0, n) \text{ and } b \in [0, n) \setminus \mathbb{Z}_n\}$ be the special quasi interval groupoid of type II. S is always non commutative.

Proof follows from the simple fact $S = \{[0, n), *, (a, b)\}$ is commutative if and only if $a = b$ in $[0, n)$. This is impossible in case of quasi special interval groupoids of type II.

Example 3.16: Let $S = \{[0, 9), *, (3, 3.2)\}$ be the quasi special interval groupoid of type II.

Clearly S is commutative and is of infinite order.

Example 3.17: Let $S = \{[0, 15), *, (4, 10.25)\}$ be the quasi special interval groupoid of type II.

S is non commutative and of infinite order.

Example 3.18: Let $S = \{[0, 121), *, (11, 1.1)\}$ be the quasi special interval groupoid of type I of infinite order.

Let $x = 2$ and $y = 3 \in S$ we find

$$\begin{aligned} x * y &= 2 * 3 = 2 \times 11 + 3 \times 1.1 \\ &= 22 + 3.3 \\ &= 25.3 \quad \dots \quad \text{I} \end{aligned}$$

$$\begin{aligned} \text{Now } y * x &= 3 * 2 \\ &= 3 \times 11 + 2 \times 1.1 \\ &= 33 + 2.2 \\ &= 35.2 \quad \dots \quad \text{II} \end{aligned}$$

I and II are distinct hence S is non commutative.

Example 3.19: Let $S = \{[0, 6), *, (1.5, 2)\}$ be the quasi special interval groupoid of type II.

S is non commutative and non associative of infinite order.

Example 3.20: Let $S = \{[0, 28), *, (1, 0.25)\}$ be the quasi special interval groupoid of type II.

$$\begin{aligned} \text{Let } a = 0.5 \text{ and } b = 10 \in S \\ a * b &= 0.5 * 10 \\ &= 0.5 \times 1 + 10 \times 0.25 \\ &= 0.5 + 2.5 \\ &= 3 \in S \quad \dots \quad \text{I} \end{aligned}$$

$$\begin{aligned} b * a &= 10 * 0.5 \\ &= 10 \times 1 + 0.5 \times 0.25 \\ &= 10 + 0.125 \\ &= 10.125 \quad \dots \quad \text{II} \end{aligned}$$

I and II are distinct so S is a non commutative groupoid.

Let $a = 2.5, b = 10$ and $c = 6 \in S$;

$$\begin{aligned} a * (b * c) &= 2.5 * (10 * 6) \\ &= 2.5 * (10 \times 1 + 6 \times 0.25) \\ &= 2.5 * (10 + 1.50) \\ &= 2.5 * 11.5 \\ &= 1 \times 2.5 + 11.5 \times 0.25 \end{aligned}$$

$$\begin{aligned} &= 2.5 + 2.875 \\ &= 5.375 \qquad \dots \text{ I} \end{aligned}$$

$$\begin{aligned} (a * b) * c &= (2.5 * 10) * 6 \\ &= (2.5 \times 1 + 10 \times 0.25) * 6 \\ &= (2.5 + 2.5) * 6 \\ &= 5 * 6 \\ &= (5 \times 1 + 6 \times 0.25) \\ &= 5 + 1.50 \\ &= 6.5 \qquad \dots \text{ II} \end{aligned}$$

Clearly I and II are distinct, hence $(S, *)$ is a non associative groupoid of type II.

Example 3.21: Let $S = \{[0, 23), *, (4.5, 10)\}$ be the quasi special interval groupoid of type II.

Z_{23} is not a subgroupoid. $P = \{0, 0.5, 1, 1.5, 2, \dots, 22, 22.5\} \subseteq [0, 23)$ is not a quasi special interval subgroupoid of S.

$$\begin{aligned} \text{For if } x &= 0.5 \text{ and } y = 2 \in S \\ x * y &= 0.5 * 2 \\ &= 0.5 \times 4.5 + 2 \times 10 \\ &= 2.25 + 20 \\ &= 22.25 \notin P. \end{aligned}$$

So P under the * operation is not a subgroupoid.

Finding subgroupoids in S is a challenging problem.

Also finding conditions for the special interval groupoid to be Smarandache groupoid or finding conditions for S to satisfy special identities etc is very difficult and they are left as open conjectures.

Example 3.22: Let $S = \{[0, 10), *, (4.5, 5.5)\}$ be the special interval groupoid of type II.

$$\text{Let } x = 2 \in S$$

$$\begin{aligned}x * x &= 4.5 * 2 + 5.5 \times 2 \\ &= 9 + 11 = 0 \pmod{10}.\end{aligned}$$

x is nilpotent of order two.

Let $x = 0.121 \in S$ we see

$$\begin{aligned}x * x &= 0.121 * 0.121 \\ &= 0.121 \times 4.5 + 0.121 \times 5.5 \\ &= 54.45 + 66.55 \\ &= 120.00 \\ &= 0 \pmod{10}.\end{aligned}$$

Thus x is a nilpotent of order two so is a zero divisor.

In fact every element x in S is a nilpotent element of order two in S .

Example 3.23: Let $M = \{[0, 13), *, (10.2, 2.8)\}$ be the special interval groupoid of type II.

M is a groupoid in which every element is nilpotent of order two.

Example 3.24: Let $S = \{[0, 24), *, (20.3, 3.7)\}$ be the special interval groupoid of type II.

S is a groupoid in which every element is nilpotent of order two.

In view of all these we have the following problem.

Let $S = \{[0, n), *, (p, t); p, t \in [0, n) \setminus \mathbb{Z}_n\}$ with $p + t \equiv 0 \pmod{n}$ be a special interval groupoid of type II.

Is every $x \in S$ such that $x * x \equiv 0 \pmod{n}$, that is nilpotent of order two?

Proof follows from the fact if $x \in S$ then

$$x * x = xp + xt = x(p+t) \equiv 0 \pmod{n} \text{ as } p + t \equiv 0 \pmod{n}.$$

Hence the claim.

Example 3.25: Let $S = \{[0, 12), *, (10.4, 2.6)\}$ be the quasi special interval groupoid of type II.

$$\begin{aligned} \text{Let } x = 3 \in S; x * x &= 10.4 \times 3 + 2.6 \times 3 \\ &= 31.2 + 7.8 \\ &= 39.0 \\ &= 3 \pmod{12}. \end{aligned}$$

Thus $x * x = x$ is an idempotent in S . Consider $y = 4.5 \in S$

$$\begin{aligned} y * y &= 10.4 \times 4.5 + 2.6 \times 4.5 \\ &= 46.80 + 11.70 \\ &= 58.50 \pmod{12} \\ &= 10.50 \neq 4.5. \end{aligned}$$

$$\begin{aligned} \text{Let } z = 10 \in S, z * z &= 10.4 \times 10 + 2.6 \times 10 \\ &= 104 + 26 \\ &= 130 \\ &= 10 \pmod{12}. \end{aligned}$$

$$\begin{aligned} \text{Let } z = 4 \in S \quad 4 \times 4 &= z * z \\ &= 4 \times 10.4 + 2.6 \times 4 \\ &= 41.6 + 10.4 \\ &= 52 \pmod{12} \\ &= 4 = z. \text{ So } z = 10 \text{ and } z = 4 \text{ are idempotents of } S. \end{aligned}$$

Let $x = 1.2 \in S$

$$\begin{aligned} \text{We see } x * x &= 10.4 \times 1.2 + 2.6 \times 1.2 \\ &= 12.48 + 3.12 \\ &= 15.60 \pmod{12} \\ &= 3.6 \neq 1.2. \end{aligned}$$

Hence $x = 1.2$ is not an idempotent.

Let $x = 3.6 \in S$ we find

$$\begin{aligned} x * x &= 10.4 \times 3.6 + 2.6 \times 3.6 \\ &= 37.44 + 9.36 \\ &= 46.80 \pmod{12} \end{aligned}$$

$$= 10.80 \neq 3.6.$$

Thus x is not an idempotent. However x has idempotents for all $x \in Z_{12}$ are idempotents of S . $x = 0$ and $x = 1$ are trivial idempotents of S .

Now take $x = 2 \in S$ is such that $x * x = 2 \pmod{12}$ when $x = 3 \in S$ we see $x * x = x \pmod{12}$.

Take $x = 4 \in S$, $x * x = x \pmod{12}$, when $x = 5 \in S$, $x * x = x \pmod{12}$;

$x = 6 \in S$ is such that $6 * 6 = 6 \pmod{12}$;

$x = 7 \in S$ is such that $7 * 7 = 7 \pmod{12}$;

$x = 8 \in S$ is such that $8 * 8 = 8 \pmod{12}$;

$x = 9 \in S$ is such that $9 * 9 = 9 \pmod{12}$;

$x = 10 \in S$ is such that $10 * 10 = 10 \pmod{12}$ and

$x = 11 \in S$ is such that $11 * 11 = 11 \pmod{12}$; .

Thus all elements in Z_{12} are idempotents.

But however all elements in $[0, 12) \setminus Z_{12}$ are not idempotents.

Let $x = 5.1 \in S$; $x * x = 5.1 \times 10.4 + 2.6 \times 5.1 = 6.3 \in S$ but $x * x \neq x$.

Hence $x = 5.1$ is not an idempotent of S .

$$\begin{aligned} \text{Let } x = 6.5 \in S \text{ we find } x * x &= 6.5 * 6.5 \\ &= 6.5 \times 10.4 + 6.5 \times 2.6 \\ &= 0.50 \neq 6.5 = x. \end{aligned}$$

Thus x is not an idempotent of S .

$$\begin{aligned} \text{Let } x = 10.2 \in S \\ x * x &= 10.2 * 10.2 = 10.2 \times 10.4 + 10.2 \times 2.6 \\ &= 0.12 \in S. \end{aligned}$$

So x is not an idempotent of S . Hence x has at least 12 idempotents including 0 and 1.

Example 3.26: Let $S = \{[0, 7), *, (3.5, 4.5)\}$ be a special interval groupoid of type II.

Let $x = 3.2 \in S$ we find

$$\begin{aligned}x * x &= 3.2 * 3.2 \\ &= 3.2 \times 3.5 + 3.2 \times 4.5 \\ &= 4.6 \neq x.\end{aligned}$$

Thus x is not an idempotent of S .

Let $x = 2 \in S$

$$\begin{aligned}x * x &= 2 * 2 \\ &= 3.5 \times 2 + 4.5 \times 2 \\ &= 2 = x.\end{aligned}$$

Hence $x = 2$ is an idempotent of S .

$$\begin{aligned}\text{Let } y &= 5 \in S; y * y = 5 * 5 \\ &= 5 \times 3.5 + 4.5 \times 5 = 5 = y.\end{aligned}$$

Thus y is also an idempotent of S .

Let $x = 3.5$ we find

$$\begin{aligned}x * x &= 3.5 * 3.5 \\ &= 3.5 \times 3.5 + 4.5 \times 3.5 \\ &= 4 \neq x.\end{aligned}$$

Thus $x = 3.5$ is not an idempotent.

Let $x = 5.2 \in S$;

$$\begin{aligned}x * x &= 5.2 \times 3.5 + 4.5 \times 5.2 \\ &= 2 \neq x.\end{aligned}$$

Thus $x = 5.2$ is not an idempotent.

Inview of all these observations we have the following theorem.

THEOREM 3.2: *Let*

*$S = \{[0, n), *, (t, s); t, s \in [0, n) \setminus \mathbb{Z}_n; t + s \equiv 1 \pmod{n}\}$ be the special interval groupoid of type II.*

S that atleast n number of idempotents including 0 and 1.

Proof is left as an exercise to the reader.

However it remains as an open problem how to construct idempotents other than those elements in \mathbb{Z}_n .

Example 3.27: Let $S = \{[0, 25), *, (15.2, 10.8)\}$ be a special interval groupoid of type II.

$$\begin{aligned} \text{Let } x = 1.5 \in S; x * x &= 1.5 * 1.5 \\ &= 15.2 \times 1.5 + 10.8 \times 1.5 \\ &= 14.00 \neq x. \end{aligned}$$

Thus x is not an idempotent of S . We see S has atleast 25 idempotents including 0 and 1. For if $z = 10 \in S$ then

$$\begin{aligned} z * z = 10 * 10 &= 10 \times 15.2 + 10 \times 10.8 \\ &= 152 + 108 \\ &= 260 \\ &= 10 \pmod{25} \text{ is an idempotent.} \end{aligned}$$

$$\begin{aligned} x = 5 \in S \text{ is such that} \\ x * x = 5 * 5 \\ &= 5 \times 15.2 + 10.8 \times 5 \\ &= 76 + 54 \\ &= 130 \\ &= 5 \pmod{25}. \end{aligned}$$

$x = 5$ is also an idempotent of S .

However we are not in a position to get idempotents in $[0, n) \setminus \mathbb{Z}_n$.

Now we see nilpotents in S .

Example 3.28: Let $S = \{[0, 12), *, (10.5, 1.5)\}$ be a special interval groupoid of type II.

$$\begin{aligned} \text{Let } x = 4 \in S; x * x &= 10.5 \times 4 + 4 \times 1.5 \\ &= 42 + 6 = 48 \equiv 0 \pmod{12}. \end{aligned}$$

$$\begin{aligned} \text{Let } x = 2.5 \in S \\ x * x &= 2.5 \times 10.5 + 1.5 \times 2.5 \\ &= 6 \neq x \text{ so } x \text{ is not a nilpotent element of } S. \end{aligned}$$

Hence it remains as an open conjecture to find those x in $[0, n) \setminus Z_n$ which are nilpotents in S .

Example 3.29: Let $S = \{[0, 9), *, (4.5, 4.5)\}$ be a special interval groupoid of type II.

$$\begin{aligned} \text{Let } x = 5 \in S; x * x &= 5 * 5 \\ &= 5 \times 4.5 + 5 \times 4.5 \\ &= 22.5 + 22.5 \\ &= 45 = 0 \pmod{9}. \end{aligned}$$

$$\begin{aligned} \text{Let } x = 4.2 \in S; x * x &= 4.2 * 4.2 \\ &= 4.2 \times 4.5 + 4.2 \times 4.5 \\ &= 1.80 \neq x. \end{aligned}$$

Thus $x = 4.2$ is not nilpotent of order two.

Example 3.30: Let $S = \{[0, 6), *, (3.5, 2.5)\}$ be a special interval groupoid of type II.

$$\begin{aligned} \text{Let } x = 2 \in S; x * x &= 2 * 2 \\ &= 3.5 \times 2 + 2.5 \times 2 \\ &= 0 \pmod{6}. \text{ So } x = 2 \text{ is a nilpotent element of } S. \end{aligned}$$

$$\begin{aligned} \text{Take } y = 5.1 \in S \text{ we find } y * y &= 5.1 \times 3.5 + 5.1 \times 2.5 \\ &= 0.60 \neq y \in S. \end{aligned}$$

Thus y is not a nilpotent element of S .

$$\begin{aligned} \text{Take } x = 1 \in S; 1 * 1 &= 1 \times 3.5 + 1 \times 1.25 \\ &= 6 \pmod{6} \\ &= 0 \text{ so } 1 \text{ is nilpotent in } S. \end{aligned}$$

$$\begin{aligned} \text{Let } x = 2 \in S; x * x &= 2 * 2 \\ &= 2 \times 3.5 + 2.5 \times 2 \\ &= 7 + 5 \\ &= 0 \pmod{6}. \end{aligned}$$

$$\begin{aligned} \text{Let } x = 3 \in S; x * x &= 3 * 3 \\ &= 3 \times 3.5 + 2.5 \times 3 \\ &= 10.5 + 7.5 \\ &= 18 \equiv 0 \pmod{6}. \end{aligned}$$

$$\begin{aligned} x = 4 \in S; x * x &= 4 * 4 \\ &= 4 \times 3.5 + 2.5 \times 4 \\ &= 14.0 + 10 \\ &= 0 \pmod{6} \end{aligned}$$

$$\begin{aligned} x = 5 \in S, x * x &= 5 * 5 \\ &= 5 * 3.5 + 5 \times 2.5 \\ &= 17.5 + 12.5 \\ &= 0 \pmod{6} \end{aligned}$$

Thus all $x \in Z_6$ are nilpotents.

It is still an open problem to find whether we can have nilpotents in $[0, 6) \setminus Z_6$.

Such study for $[0, n) \setminus Z_n$ is unsettled.

Example 3.31: Let $S = \{[0, 15), *, (12.5, 2.5)\}$ be a special interval groupoid of infinite order.

$$\begin{aligned} \text{Let } x = 6 \in S; x * x &= 6 * 6 \\ &= 6 \times 12.5 + 6 \times 2.5 \end{aligned}$$

$$\begin{aligned}
 &= 75.0 + 15.0 \\
 &= 0 \pmod{15} \text{ is nilpotent of order two.}
 \end{aligned}$$

$$\begin{aligned}
 \text{Let } x &= 1.2 \in S; x * x = 1.2 * 1.2 \\
 &= 1.2 \times 12.5 + 2.5 \times 1.2 \\
 &= 15.00 + 3.00 \\
 &= 18 \pmod{15} \\
 &= 3 \neq x. \text{ So } x \text{ is not nilpotent in } S.
 \end{aligned}$$

We see in general $x \in [0, n) \setminus Z_n$ are not nilpotents in S .

We conjecture for what values of (t, s) in $S = \{[0, n), *, (t, s)\}$; $t, s \in [0, n) \setminus Z_n$ $x \in [0, n) \setminus Z_n$ will be nilpotent of order two.

Let $S = \{[0, n), *, (t, s); t, s \in [0, n) \setminus Z_n \text{ with } t + s \equiv 0 \pmod{n}\}$ be the special interval groupoid of type II. Then we know all $x \in Z_n$ are nilpotent of order two.

Can we find $x \in [0, n) \setminus Z_n$ such that $x * x = tx + sx = 0$? remains as an open problem.

Example 3.32: Let $S = \{[0, 5), *, (2.5, 2.5)\}$ be the special interval groupoid of type II.

$$\begin{aligned}
 \text{Let } x &= 3.2 \in S \text{ now } x * x = 2.5 * 2.5 = 3.2 \times 2.5 + 3.2 \times 2.5 \\
 &= 8.00 + 8.00 \\
 &= 1 \text{ is a unit in } S.
 \end{aligned}$$

$$\begin{aligned}
 \text{Let } x &= 1.6 \in S \\
 x * x &= 1.6 * 1.6 \\
 &= 2.5 \times 1.6 + 2.5 \times 1.6 \\
 &= 4.00 + 4.00 \\
 &= 3.
 \end{aligned}$$

Let $a = 2 \in S$ we find $2 \times 2 = 2.5 \times 2 + 2.5 \times 2 = 0$ so 2 is a nilpotent element of S .

$$\begin{aligned} \text{Let } b = 4.8 \in S, b * b &= 4.8 * 4.8 = 4.8 \times 2.5 + 4.8 \times 2.5 \\ &= 12 + 12 \\ &= 4. \end{aligned}$$

$$\begin{aligned} \text{Let } x = 0.8 \in S \\ x * x &= 0.8 * 0.8 \\ &= 0.8 \times 2.5 + 0.8 \times 2.5 \\ &= 2.00 + 2.00 \\ &= 4 \in S. \end{aligned}$$

$$\begin{aligned} \text{Let } a = 0.9 \in S \\ a * a &= 0.9 * 0.9 \\ &= 0.9 \times 2.5 + 0.9 \times 2.9 \\ &= 2.25 + 2.25 \\ &= 4.5. \end{aligned}$$

$$\begin{aligned} \text{Let } b = 0.4 \in S, b * b &= 0.4 * 0.4 \\ &= 0.4 \times 2.5 + 0.4 \times 2.5 \\ &= 1.00 + 1.00 \\ &= 2 \in S. \end{aligned}$$

$$\begin{aligned} \text{Let } a = 1.2 \in S \\ a * a &= 1.2 * 1.2 \\ &= 1.2 \times 2.5 + 1.2 \times 2.5 \\ &= 3.00 + 3.00 \\ &= 1 \in S. \end{aligned}$$

Thus S has units under $*$.

$$\begin{aligned} \text{Let } c = 4.2 \in S \\ c * c &= 4.2 * 4.2 \\ &= 4.2 \times 2.5 + 4.2 \times 2.5 \\ &= 10.50 + 10.50 \\ &= 1 \text{ is again a unit in } S. \end{aligned}$$

$$\begin{aligned} \text{Let } a = 3.4 \in S \\ a * a &= 3.4 * 3.4 \\ &= 3.4 \times 2.5 + 3.4 \times 2.5 \\ &= 2 \in S. \end{aligned}$$

$$\begin{aligned}
&\text{Let } x = 4.2 \in S \\
&x * x = 4.2 * 4.2 \\
&= 4.2 \times 2.5 + 4.2 \times 2.5 \\
&= 10.50 + 10.50 \\
&= 1 \in S \text{ is a unit of } S.
\end{aligned}$$

Thus these special interval groupoids of type II contain units. However $[0, n)$ under product does not contain units. This is the speciality about these type II groupoids.

However it is left as an open problem to find the condition of (t, s) of the $S = \{[0, n), *, (t, s)\}$ to have units and also the properties associated with units.

Example 3.33: Let $S = \{[0, 7), *, (3.5, 3.5)\}$ be the special interval groupoid of type II.

$$\begin{aligned}
&\text{Let } x = 2.2 \in S \\
&x * x = 2.2 * 2.2 \\
&= 2.2 \times 3.5 + 2.2 \times 3.5 \\
&= 7.70 + 7.70 \pmod{7} \\
&= 15.40 \pmod{7} \\
&= 1.40 \in S.
\end{aligned}$$

$$\begin{aligned}
&\text{Let } y = 4.3 \in S \\
&y * y = 4.3 * 4.3 \\
&= 4.3 \times 3.5 + 4.3 \times 3.5 \\
&= 2.1 \in S.
\end{aligned}$$

$$\begin{aligned}
&\text{Let } x = 3.2 \in S \\
&x * x = 3.2 * 3.2 \\
&= 3.2 \times 3.5 + 3.2 \times 3.5 \\
&= 1.40 \in S.
\end{aligned}$$

It is left as an exercise to the reader to find units in S .

Example 3.34: Let $S = \{[0, 9), *, (4.5, 4.5)\}$ be the special interval groupoid of type II.

$$\begin{aligned}
 &\text{Let } x = 3 \in S \\
 &x * x = 3 * 3 \\
 &= 3 \times 4.5 + 3 \times 4.5 \\
 &= 13.5 + 13.5 = 27 \\
 &= 0 \pmod{9}.
 \end{aligned}$$

$x = 3$ is a nilpotent element of order two.

$$\begin{aligned}
 &\text{Let } x = 2 \in S \\
 &x * x = 2 * 2 \\
 &= 2 \times 4.5 + 2 \times 4.5 \\
 &= 9 + 9 \\
 &= 0 \pmod{9}.
 \end{aligned}$$

Thus type II groupoids lead to several new properties enjoyed by their elements.

The reader is left with the task of studying for these type II groupoids; the notion of Smarandache units (S-units), Smarandache idempotents (S-idempotents) and Smarandache zero divisors (S-zero divisors). However we have shown by examples; type II groupoids can contain nilpotents, units and idempotents.

Now we give other type II groupoids built using matrices.

Example 3.35: Let

$M = \{(a_1, a_2, \dots, a_6) \mid a_i \in [0, 7), *, (3.1, 2.7); 1 \leq i \leq 6\}$ be a special interval row matrix groupoid of type II.

Clearly we have subgroupoids of infinite order.

Example 3.36: Let

$M = \{(a_1, a_2, a_3) \mid a_i \in [0, 11), *, (5.5, 5.5); 1 \leq i \leq 3\}$ be a special interval row matrix groupoid of type II.

S has special elements which are zero divisors, units and idempotents.

Example 3.37: Let

$S = \{(a_1, a_2, \dots, a_9) \mid a_i \in [0, 24), *, (20.75, 0); 1 \leq i \leq 9\}$ be a special interval row matrix groupoid of type II.

Example 3.38: Let

$M = \{[0,23), *, (12.5, 10)\}$ be a type II groupoid of infinite order.

Let $N = \{(a_1, a_2, a_3, a_4, a_5, a_6) \mid a_i \in [0, 23), *, 1 \leq i \leq 6; (12.5, 10)\}$ be a type II row matrix groupoid of infinite order.

This has subgroupoids of infinite order.

Example 3.39: Let

$M = \{(a_1 \mid a_2 \ a_3 \ a_4 \mid a_5 \ a_6 \mid a_7) \mid a_i \in [0, 14), *, (8.5, 6); 1 \leq i \leq 7\}$ be a special interval row matrix groupoid of type II of super row matrices.

M has subgroupoids.

Example 3.40: Let

$$M = \left\{ \left[\begin{array}{c} a_1 \\ a_2 \\ a_3 \\ a_4 \\ a_5 \\ a_6 \end{array} \right] \mid a_i \in [0, 10), *, (8.13, 4.723); 1 \leq i \leq 6 \right\}$$

be a special interval row matrix groupoid of type II.

$$P = \left\{ \begin{bmatrix} a_1 \\ 0 \\ 0 \\ 0 \\ 0 \\ 0 \end{bmatrix} \mid a_i \in [0, 10), *, (8.13, 4.723) \} \subseteq S$$

be a special interval column matrix groupoid of type II and is isomorphic with $M = \{[0, 10), *, (8.13, 4.723)\}$; a groupoid of type II.

Example 3.41: Let

$$P = \left\{ \begin{bmatrix} a_1 \\ a_2 \\ \vdots \\ a_7 \end{bmatrix} \mid a_i \in [0, 9), *, (3.7, 5); 1 \leq i \leq 9 \}$$

be a special interval column matrix groupoid of type II.

$o(P) = \infty$. P has several subgroupoids of infinite order and some subgroupoids of finite order.

Example 3.42: Let

$$M = \left\{ \begin{bmatrix} a_1 \\ a_2 \\ \vdots \\ a_{12} \end{bmatrix} \mid a_i \in [0, 71), *, (70.009, 10); 1 \leq i \leq 12 \}$$

be a special interval column matrix groupoid of type II.

$$P_1 = \left\{ \begin{bmatrix} a_1 \\ 0 \\ \vdots \\ 0 \end{bmatrix} \right\} a_1 \in [0, 71) \subseteq M,$$

$$P_2 = \left\{ \begin{bmatrix} 0 \\ a_2 \\ \vdots \\ 0 \end{bmatrix} \right\} a_2 \in [0, 71) \subseteq M,$$

$$P_3 = \left\{ \begin{bmatrix} 0 \\ 0 \\ a_3 \\ 0 \\ \vdots \\ 0 \end{bmatrix} \right\} a_3 \in [0, 71) \subseteq M, \text{ and so on,}$$

$$P_{12} = \left\{ \begin{bmatrix} 0 \\ 0 \\ \vdots \\ a_{12} \end{bmatrix} \right\} a_{12} \in [0, 71) \subseteq M$$

are all special interval subgroupoids of type II of infinite order.

$$P_i \cap P_j = \left\{ \begin{bmatrix} 0 \\ 0 \\ \vdots \\ 0 \end{bmatrix} \right\} \text{ if } i \neq j; 1 \leq i, j \leq 12.$$

Example 3.43: Let

$$M = \left\{ \left[\begin{array}{c} a_1 \\ a_2 \\ a_3 \\ a_4 \\ a_5 \\ a_6 \\ a_7 \\ a_8 \\ a_9 \\ a_{10} \end{array} \right] \mid a_i \in [0, 17), *, (12.5, 4.5); 1 \leq i \leq 10 \right\}$$

be a special interval column matrix groupoid of type II.

M has subgroupoids of infinite order.

Example 3.44: Let

$$M = \left\{ \left[\begin{array}{c} a_1 \\ a_2 \\ a_3 \\ a_4 \\ a_5 \\ a_6 \end{array} \right] \mid a_i \in [0, 21), *, (2.75, 10.25); 1 \leq i \leq 6 \right\}$$

be a special interval column matrix groupoid of type II.

M also has subgroupoids of infinite order.

Example 3.45: Let

$$M = \left\{ \left[\begin{array}{ccc} a_1 & a_2 & a_3 \\ a_4 & a_5 & a_6 \\ \vdots & \vdots & \vdots \\ a_{28} & a_{29} & a_{30} \end{array} \right] \mid a_i \in [0, 43), *, (29.3, 0); 1 \leq i \leq 30 \right\}$$

be a special interval column matrix groupoid of type II.

M has several subgroupoids of infinite order.

Example 3.46: Let

$$S = \left\{ \left[\begin{array}{cccc} a_1 & a_2 & a_3 & a_4 \\ a_5 & a_6 & a_7 & a_8 \\ a_9 & a_{10} & a_{11} & a_{12} \\ a_{13} & a_{14} & a_{15} & a_{16} \\ a_{17} & a_{18} & a_{19} & a_{20} \\ a_{21} & a_{22} & a_{23} & a_{24} \\ a_{25} & a_{26} & a_{27} & a_{28} \\ a_{29} & a_{30} & a_{31} & a_{32} \end{array} \right] \mid a_i \in [0, 17), *, (3.8, 13.2); 1 \leq i \leq 32 \right\}$$

be a special interval column matrix groupoid of type II of infinite order. S is a super matrix special interval groupoid of type II.

This has several subgroupoids of infinite order.

Example 3.47: Let

$$S = \left\{ \left[\begin{array}{ccccc} a_1 & a_2 & a_3 & a_4 & a_5 \\ a_6 & a_7 & a_8 & a_9 & a_{10} \\ a_{11} & a_{12} & a_{13} & a_{14} & a_{15} \end{array} \right] \mid a_i \in [0, 3), *, (1.5, 1.5); 1 \leq i \leq 15 \right\}$$

be a special interval column matrix groupoid of type II.

Clearly S is commutative.

Example 3.48: Let

$M = \{(a_1, a_2, a_3, a_4) \mid a_i \in [0, 5), *, (1.6, 1.6); 1 \leq i \leq 4\}$ be a special interval row matrix groupoid of infinite order.

$$\begin{aligned} \text{Let } x &= (0.3, 0.2, 0.9, 1.2) \text{ and } y = (2.1, 2, 3.1, 3.5) \in M. \\ x * y &= (0.3, 0.2, 0.9, 1.2) * (2.1, 2, 3.1, 3.5) \\ &= 0.3 * 2.1, 0.2 * 2, 0.9 * 3.1, 1.2 * 3.5 \\ &= 0.48 + 3.36, 0.32 + 3.2, 1.44 + 4.96, 1.92 + 5.60 \\ &= (3.84, 3.52, 1.40, 2.52) \qquad \dots \text{ I} \end{aligned}$$

$$\begin{aligned} \text{Consider } y * x &= (2.1, 2, 3.1, 3.5) * (0.3, 0.2, 0.9, 1.2) \\ &= (2.1 * 0.3, 2 * 0.2, 3.1 * 0.9, 3.5 * 1.2) \\ &= (3.36 + 0.48, 3.2 + 0.3, 4.96 + 1.44, 5.10 + 1.92) \\ &= (3.84, 3.52, 1.40, 2.52) \qquad \dots \text{ II} \end{aligned}$$

Clearly I and II are so $x * y = y * x$. It is pertinent to keep on record $x * y = y * x$ for all $y, x \in M$.

THEOREM 3.3: Let $M = \left\{ \left[\begin{array}{ccc} a_{11} & \dots & a_{1n} \\ \vdots & & \vdots \\ a_{m1} & \dots & a_{mn} \end{array} \right] \mid a_{ij} \in [0, n), (s, s), \right.$

$s \in [0, n) \setminus Z_n, 1 \leq i \leq m, 1 \leq j \leq n, * \}$ be the special interval matrix groupoid of type II.

M is a commutative groupoid of type II.

Proof is direct and hence left as an exercise to the reader.

Example 3.49: Let $T = \left\{ \begin{bmatrix} a_1 \\ a_2 \\ a_3 \\ a_4 \\ a_5 \end{bmatrix} \mid a_i \in [0, 6), *, (3.1, 0); 1 \leq i \leq 5 \right\}$

be a special interval column matrix groupoid of type II of infinite order.

$$\text{Let } x = \begin{bmatrix} 2.6 \\ 0 \\ 1.5 \\ 0 \\ 2 \end{bmatrix} \text{ and } y = \begin{bmatrix} 0 \\ 3.1 \\ 0 \\ 4.1 \\ 0 \end{bmatrix} \in T.$$

$$x * y = \begin{bmatrix} 2.6 \\ 0 \\ 1.5 \\ 0 \\ 2 \end{bmatrix} * \begin{bmatrix} 0 \\ 3.1 \\ 0 \\ 4.1 \\ 0 \end{bmatrix}$$

$$= \begin{bmatrix} 2.6 * 0 \\ 0 * 3.1 \\ 1.5 * 0 \\ 0 * 4.1 \\ 2 * 0 \end{bmatrix} = \begin{bmatrix} 2.6 \times 3.1 \\ 0 \\ 1.5 \times 3.1 \\ 0 \\ 2 \times 3.1 \end{bmatrix}$$

$$= \begin{bmatrix} 2.06 \\ 0 \\ 4.65 \\ 0 \\ 0.2 \end{bmatrix} \quad \dots \quad \text{I}$$

$$y * x = \begin{bmatrix} 0 \\ 3.1 \\ 0 \\ 4.1 \\ 0 \end{bmatrix} * \begin{bmatrix} 2.6 \\ 0 \\ 1.5 \\ 0 \\ 2 \end{bmatrix}$$

$$= \begin{bmatrix} 0 \\ 3.1 \times 3.1 \\ 0 \\ 4.1 \times 3.1 \\ 0 \end{bmatrix}$$

$$= \begin{bmatrix} 0 \\ 3.61 \\ 0 \\ 0.71 \\ 0 \end{bmatrix} \quad \dots \quad \text{II}$$

I and II are distinct so T is not a commutative groupoid.

Example 3.50: Let

$M = \{(a_1, a_2, a_3, a_4) \mid a_i \in [0, 8), *, (0, 4.2); 1 \leq i \leq 4\}$ be a special interval row matrix groupoid of type II.

M is a non commutative groupoid of type II.

Example 3.51: Let

$$M = \left\{ \begin{bmatrix} a_1 & a_2 & a_3 \\ a_4 & a_5 & a_6 \\ a_7 & a_8 & a_9 \\ a_{10} & a_{11} & a_{12} \\ a_{13} & a_{14} & a_{15} \end{bmatrix} \mid a_i \in [0, 21), *, (17, 20.123); 1 \leq i \leq 15 \right\}$$

be a special interval column matrix groupoid of type II of infinite order.

Example 3.52: Let

$$M = \left\{ \begin{bmatrix} a_1 & a_2 & \dots & a_6 \\ a_7 & a_8 & \dots & a_{12} \\ \vdots & \vdots & & \vdots \\ a_{30} & \dots & \dots & a_{36} \end{bmatrix} \mid a_i \in [0, 13), *, (6.5, 6.5); 1 \leq i \leq 36 \right\}$$

be a special interval column matrix groupoid of type II.

M is commutative. M has units.

Now we proceed onto describe special interval groupoids of type II with examples.

Example 3.53: Let $W = \{[a, b] \mid a, b \in [0, 10), *, (3.5, 0.8)\}$ be a special interval column matrix groupoid of type II.

$$\begin{aligned} \text{Let } x &= [0.9, 2] \text{ and } y = [8, 3.1] \in W \\ x * y &= [0.9, 2] * [8, 3.1] \\ &= [0.9 * 8, 2 * 3.1] \\ &= [0.9 \times 3.5 + 0.8 \times 8, 2 \times 3.5 + 3.1 \times 0.8] \\ &= [3.15 + 6.4, 7 + 2.48] \\ &= [9.55, 9.48] \qquad \dots \text{ I} \\ y * x &= [8, 3.1] * [0.9, 2] \end{aligned}$$

$$\begin{aligned}
 &= [8 \times 3.5 + 0.9 \times 0.8, 3.1 \times 3.5 + 0.8 \times 2] \\
 &= [28.0 + 7.2, 10.85 + 1.6] \\
 &= [5.2, 2.45] \qquad \dots \text{ II}
 \end{aligned}$$

I and II are distinct so W is a non commutative type II groupoid.

Example 3.54: Let $M = \{[a, b] \mid a, b \in [0, 20), *, (15.2, 4)\}$ be a special interval column matrix groupoid of type II.

M is of infinite order. $P = \{[a, 0] \mid a \in [0, 20), (15.2, 4), *\}$ is a subgroupoid of M of infinite order.

Likewise $T = \{[0, a] \mid a \in [0, 20), (15.2, 4), *\} \subseteq M$ is a subgroupoid of M of infinite order in M .

Example 3.55: Let $M = \{[a, b] \mid a, b \in [0, 23), *, (20.3, 0)\}$ be a special interval column matrix groupoid of type II.

Let $P = \{[a, 0] \mid a \in [0, 23), (20.3, 0), *\}$ be a special interval subgroupoid.

Consider $T = \{[0, a] \mid a \in [0, 23), (20.3, 0), *\} \subseteq M$; T is special interval subgroupoid of M .

Now let $x = [0, 3]$ and $y = [0, 2] \in T$.

$$\begin{aligned}
 x * y &= [0, 3] * [0, 2] \\
 &= [0, 3 * 2] \\
 &= [0, 20.3 \times 3 + 2 \times 0] \\
 &= [0, 60.9] \\
 &= [0, 14.9] \in T \qquad \dots \text{ I}
 \end{aligned}$$

$$\begin{aligned}
 y * x &= [0, 2] * [0, 3] \\
 &= [0, 2 * 3] \\
 &= [0, 2 \times 20.3 + 3 \times 0] \\
 &= [0, 40.6] \\
 &= [0, 17.6] \in T \qquad \dots \text{ II}
 \end{aligned}$$

Clearly I and II are distinct so T is a non commutative subgroupoid of type II.

We can have type II groupoids built using the intervals $[a, b]$ with $a, b \in [0, n)$.

Example 3.56: Let $M = \{([a_1, b_1], [a_2, b_2], [a_3, b_3]) \mid a_i, b_i \in [0, 9), 1 \leq i \leq 3, (3, 6.5), *\}$ be the special interval groupoid of type II.

Clearly M is non commutative and is of infinite order. M has atleast 6 subgroupoids isomorphic with the groupoid $G = \{[0, 9), *, (3, 6.5)\}$.

Example 3.57: Let $M = \{([a_1, b_1], [a_2, b_2], [a_3, b_3], [a_4, b_4], [a_5, b_5], [a_6, b_6]) \mid a_i, b_i \in [0, 9), 1 \leq i \leq 6, (4.5, 4.5), *\}$ be the special interval groupoid of type II of infinite order. Clearly M is a commutative groupoid.

Example 3.58: Let $T = \{([a_1, b_1], [a_2, b_2], [a_3, b_3], [a_4, b_4], [a_5, b_5]) \mid a_i, b_i \in [0, 13), 1 \leq i \leq 5, (6.5, 0), *\}$ be the special interval groupoid of type II which is non commutative and is of infinite order.

Example 3.59: Let

$$M = \left\{ \left[\begin{array}{c} [a_1, b_1] \\ [a_2, b_2] \\ \vdots \\ [a_7, b_7] \end{array} \right] \mid a_i, b_i \in [0, 13), (9.5, 3.5), *, 1 \leq i \leq 7 \right\}$$

be the special interval groupoid of type II of infinite order.

Example 3.60: Let

$$M = \left\{ \left[\begin{array}{c} [a_1, b_1] \\ [a_2, b_2] \\ \vdots \\ [a_{12}, b_{12}] \end{array} \right] \mid a_i, b_i \in [0, 15), (7.5, 7.5), *, 1 \leq i \leq 12 \right\}$$

be the special interval groupoid of type II of infinite order.

Clearly T is commutative. T has several subgroupoids of type II which are commutative and of infinite order.

Example 3.61: Let

$$S = \left\{ \left[\begin{array}{c} [a_1, b_1] \\ [a_2, b_2] \\ [a_3, b_3] \\ [a_4, b_4] \\ [a_5, b_5] \\ [a_6, b_6] \\ [a_7, b_7] \end{array} \right] \mid a_i, b_i \in [0, 17), (15.5, 2.5), *, 1 \leq i \leq 7 \right\}$$

be the special interval groupoid of type II.

S has several units and subgroupoids of infinite order.

Example 3.62: Let $M = \{([a_1, b_1] \mid [a_2, b_2] [a_3, b_3] [a_4, b_4] \mid [a_5, b_5] [a_6, b_6]) \mid a_i, b_i \in [0, 21), 1 \leq i \leq 6, (5.2, 4.204), *)\}$ be the special interval super matrix groupoid of infinite order of type II.

Example 3.63: Let

$$M = \left\{ \begin{bmatrix} [a_1, b_1] & [a_2, b_2] \\ [a_3, b_3] & [a_4, b_4] \\ \vdots & \vdots \\ [a_{13}, b_{13}] & [a_{14}, b_{14}] \end{bmatrix} \mid a_i, b_i \in [0, 26), (13.5, 13.5), *, \right.$$

$1 \leq i \leq 14\}$ be the special interval super matrix groupoid.

We see M has infinite number of subgroupoids.

Example 3.64: Let

$$P = \left\{ \begin{bmatrix} [a_1, b_1] & [a_2, b_2] \\ [a_3, b_3] & [a_4, b_4] \\ [a_5, b_5] & [a_6, b_6] \\ [a_7, b_7] & [a_8, b_8] \\ [a_9, b_9] & [a_{10}, b_{10}] \\ [a_{11}, b_{11}] & [a_{12}, b_{12}] \\ [a_{13}, b_{13}] & [a_{14}, b_{14}] \end{bmatrix} \mid a_i, b_i \in [0, 29), (26.3, 2.7), *, \right.$$

$1 \leq i \leq 14\}$ be the special interval super column matrix groupoid of type II of infinite order.

This has several subgroupoids of infinite order.

Example 3.65: Let

$$P = \left\{ \begin{bmatrix} [a_1, b_1] & [a_2, b_2] & [a_3, b_3] \\ [a_4, b_4] & [a_5, b_5] & [a_6, b_6] \\ [a_7, b_7] & [a_8, b_8] & [a_9, b_9] \end{bmatrix} \mid a_i, b_i \in [0, 12), (10.5, 2.5), \right.$$

$*, 1 \leq i \leq 9\}$ be the special matrix groupoid of type II of infinite order.

B has subgroupoids of infinite order.

Example 3.66: Let

$$M = \left\{ \left[\begin{array}{c|c|c} [a_1, b_1] & [a_2, b_2] & [a_3, b_3] \\ \hline [a_4, b_4] & [a_5, b_5] & [a_6, b_6] \\ \hline [a_7, b_7] & [a_8, b_8] & [a_9, b_9] \\ \hline [a_{11}, b_{11}] & \dots & \dots \\ \hline [a_{13}, b_{13}] & \dots & \dots \\ \hline [a_{16}, b_{16}] & \dots & \dots \end{array} \right] \right\} \quad a_i, b_i \in [0, 20),$$

$$(10.32, 7.68), *, 1 \leq i \leq 18\}$$

be the special interval super matrix groupoid of type II of infinite order.

Now we see in case of type II groupoids built using the interval $[0, n]$; we are not in a position to speak about special identities in this case.

Thus it is a challenging open problem to find the groupoids of type II to satisfy special identities.

We suggest the following problems.

Problems:

1. Find conditions on $s, t \in [0, n] \setminus Z_n$, where $G = \{[0, n], *, (s, t)\}$ to be a P-groupoid of type II.
2. Let $G = \{[0, n], *, (s, t); s \in [0, n] \setminus Z_n \text{ and } t \in Z_n\}$ be the special interval groupoid of type II.

For what values of s and t in G ; G is a P-groupoid or a S-strong P-groupoid or a S-P-groupoid.

3. Let $G = \{[0, n), *, (s, t), s, t \in [0, n) \setminus Z_n, t + s \equiv 0 \pmod{n}\}$ be the type II groupoid.

What are the special identities satisfied by G ?

4. Let $G = \{[0, n), *, (s, t), s, t \in [0, n) \setminus Z_n \text{ with } s + t \equiv 1 \pmod{n}\}$ be the special interval groupoid of type II.

Find all the special identities satisfied by G .

5. Let $G = \{[0, n), *, (s, t); s, t \in [0, n) \setminus Z_n\}$ be the special interval groupoid of type II.

Find all the special identities satisfied by G .

6. Study problem 5 when G is such that $s \in Z_n$ and $t \in [0, n) \setminus Z_n$.

7. Characterize those groupoids

$G = \{[0, n), *, (s, t); s, t \in [0, n) \setminus Z_n\}$ which are Smarandache.

8. Can a type II groupoid built on $[0, n)$ be a normal groupoid?
9. Can a type II groupoid built on $[0, n)$ have normal subgroupoids?
10. Can type II groupoids built using $[0, n)$ have seminormal subgroupoids of type II?
11. Obtain some special features enjoyed by special interval groupoid of type II.
12. Prove every special interval groupoid of type II built using $[0, n)$ is of infinite order.
13. Can $S = \{[0, 9), *, (1.2, 5.5)\}$ be a S-special interval groupoid of type II?

14. Can $S = \{[0, 16), *, (5.7, 10.3)\}$, the S-special interval groupoid of type II satisfy any of the special identities?
15. Give an example of a special interval groupoid of type II which satisfy the S-strong Bol identity?
16. Does there exist a special interval groupoid of type II which satisfies the Moufang identity?
17. Can any special interval groupoid of type II satisfy Bruck identity?
18. Does there exist a special interval groupoid of type II which is an idempotent groupoid?
19. Let $S = \{[0, 15), *, (2.115, 0.115)\}$ be a special interval groupoid of type II.
 - (i) Can S have subgroupoids of finite order?
 - (ii) Find all subgroupoids of S.
 - (iii) Does S satisfy any of the special identities?
 - (iv) Can S have right ideals which are not left ideals?
 - (v) Is S normal?
 - (vi) Can S have seminormal subgroupoids?
 - (vii) Does S have conjugate subgroupoids?
 - (viii) Can S have semiconjugate subgroupoids?
 - (ix) Is S a Smarandache special interval groupoid?

20. Let $S = \{[0, 21), *, (10.25, 10.75)\}$ be a special interval groupoid of type II.

Study questions (i) to (ix) of problem 19 for this groupoid S.

21. Let $S_1 = \{[0, 5), *, (3.5, 1.5)\}$ be a special interval groupoid of type II.

Study questions (i) to (ix) of problem 19 for this groupoid S.

22. Compare type I groupoids with type II groupoids?
23. Is it ever possible to have subgroupoids of finite order in case of type II groupoids?
24. Let $S = \{[0, 15), *, (10.001, 4.999)\}$ be a special interval groupoid of type II.

Study questions (i) to (ix) of problem 19 for this S .

25. Let $S = \{[0, 11), *, (5.5, 5.5)\}$ be a special interval groupoid of type II.

Study questions (i) to (ix) of problem 19 for this S .

Prove S is commutative.

Show every $x \in S$ is a nilpotent of order two.

26. Let $S = \{[0, 3), *, (1.5, 1.5)\}$ be a special interval groupoid of type II.

- (i) Study questions (i) to (ix) of problem 19 for this S .
- (ii) Find all nilpotents of order two.
- (iii) Find all idempotents of S .
- (iv) Find all units of S .

27. Let $S = \{[0, 15), *, (7.5, 7.5)\}$ be the special interval type II groupoid.

- (i) Study questions (i) to (ix) of problem 19 for this S .
- (ii) Find all idempotent elements of S .
- (iii) Find all units in S .
- (iv) Can S have nilpotent elements of order two?
- (v) Can S have S -zero divisors?
- (vi) Can S have S -units?
- (vii) Can S have S -idempotents?
- (viii) Obtain some special properties enjoyed by this S .

28. Let $S = \{[0, 25), *, (12.5, 12.5)\}$ be the special interval groupoid of type II.

Study questions (i) to (viii) of problem 27 for this S .

29. Let $S = \{[0, 27), *, (13.5, 13.5)\}$ be the special interval groupoid of type II.

Study questions (i) to (viii) of problem 27 for this S .

30. Let $S = \{[0, 43), *, (22.5, 21.5)\}$ be the special interval groupoid of type II.

Study questions (i) to (viii) of problem 27 for this S .

31. Let $S = \{[0, 16), *, (14.5, 1.5)\}$ be the special interval groupoid of type II.

Study questions (i) to (viii) of problem 27 for this S .

32. Let $S = \{[0, 45), *, (22.5, 22.5)\}$ be the special interval groupoid of type II.

Study questions (i) to (viii) of problem 27 for this S .

33. Let $S = \{[0, 210), *, (200.9, 9.1)\}$ be the special interval groupoid of type II.

Study questions (i) to (viii) of problem 27 for this S .

34. Let $S = \{[0, 18), *, (16.2, 2.8)\}$ be the special interval groupoid of type II.

Study questions (i) to (viii) of problem 27 for this S .

35. Let $S = \{[0, 19), *, (15.45, 4.55)\}$ be the special interval groupoid of type II.

Study questions (i) to (viii) of problem 27 for this S .

36. Let $S = \{[0, 21), *, (16.37, 4.63)\}$ be the special interval groupoid of type II.

Study questions (i) to (viii) of problem 27 for this S.

37. Let $S = \{[0, 10), *, (9.7, 1.3)\}$ be the special interval groupoid of type II.

Study questions (i) to (viii) of problem 27 for this S.

38. Let $S = \{[0, 8), *, (6.3, 2.7)\}$ be the special interval groupoid of type II.

Study questions (i) to (viii) of problem 27 for this S.

39. Let

$S = \{(a_1, a_2, a_3, a_4, a_5) \mid a_i \in [0, 21), 1 \leq i \leq 5, (3.7, 10.3), *\}$ be the special interval groupoid of type II.

Study questions (i) to (viii) of problem 27 for this S.

40. Let

$S = \{(a_1, a_2, a_3, a_4, a_5) \mid a_i \in [0, 13), 1 \leq i \leq 5, (6.5, 6.5), *\}$ be the special interval groupoid of type II.

- (i) Study questions (i) to (viii) of problem 27 for this S.
- (ii) Can T have zero divisors?
- (iii) Find all units of T.

41. Let

$S = \{(a_1, a_2, \dots, a_{10}) \mid a_i \in [0, 16), 1 \leq i \leq 10, (14.3, 2.7), *\}$ be the special interval row matrix groupoid of type II.

- (i) Study questions (i) to (viii) of problem 27 for this S.
- (ii) Can S have zero divisor?
- (iii) Does S contain S-units?
- (iv) Can S have S-idempotents?

42. Let $S = \{(a_1 | a_2 a_3 | a_4 a_5 a_6 | a_7 a_8 | a_9) | a_i \in [0, 43), 1 \leq i \leq 9, (23.7, 20.3), *\}$ be the special interval super row matrix groupoid of type II.

- (i) Study questions (i) to (viii) of problem 27 for this S.
- (ii) Can S have zero divisors?
- (iii) Can S have zero divisors which are not S-zero divisors?
- (iv) Can S have units which are not S-units?

43. Let

$$S = \left\{ \left[\begin{array}{c} a_1 \\ a_2 \\ \vdots \\ a_{10} \end{array} \right] \mid a_i \in [0, 21), *, (10.5, 10.5); 1 \leq i \leq 10 \right\}$$

be the special column matrix groupoid of type II.

- (i) Study questions (i) to (viii) of problem 27 for this S.
- (ii) Is it possible for S to have S-zero divisor?
- (iii) Does S contain idempotents which are not S-idempotents?
- (iv) Find all S-units of S.

44. Let

$$S = \left\{ \left[\begin{array}{c} a_1 \\ a_2 \\ \vdots \\ a_{11} \end{array} \right] \mid a_i \in [0, 19), *, (16.5, 3.5); 1 \leq i \leq 11 \right\}$$

be the special interval column matrix groupoid of type II.

- (i) Study questions (i) to (viii) of problem 27 for this T.
- (ii) Can T have S-zero divisors?

- (iii) Find all S-idempotents.
- (iv) Find all idempotents which are not S-idempotents.

45. Let

$$S = \left\{ \left[\begin{array}{c} a_1 \\ a_2 \\ \vdots \\ a_{15} \end{array} \right] \mid a_i \in [0, 15), *, (0, 14.3); 1 \leq i \leq 15 \right\}$$

be the special interval column matrix groupoid of type II.

- (i) Study questions (i) to (viii) of problem 27 for this M.
- (ii) Find all units which are S-units.
- (iii) Find all idempotents which are not S-idempotents.
- (iv) Can T have S-zero divisors?
- (v) Find all S-idempotents.
- (vi) Find all idempotents which are not S-idempotents.

46. Let

$$S = \left\{ \left[\begin{array}{c} a_1 \\ a_2 \\ \vdots \\ a_{19} \end{array} \right] \mid a_i \in [0, 12), *, (10.5, 7); 1 \leq i \leq 19 \right\}$$

be the special interval column matrix groupoid of type II of infinite order.

- (i) Study questions (i) to (viii) of problem 27 for this M.
- (ii) Can M have S-units?
- (iii) Can M have S-idempotents?

47. Let

$$M = \left\{ \begin{array}{c} \left[\begin{array}{c} a_1 \\ a_2 \\ a_3 \\ a_4 \\ a_5 \\ a_6 \\ a_7 \\ a_8 \end{array} \right] \\ a_i \in [0, 18), *, (9.8, 9.2); 1 \leq i \leq 8 \end{array} \right.$$

be a special interval super column matrix groupoid of type II.

- (i) Study questions (i) to (viii) of problem 27 for this S.
- (ii) Can S have S-idempotents?
- (iii) Find all S-units of S.

48. Let

$$M = \left\{ \begin{array}{c} \left[\begin{array}{c} a_1 \\ a_2 \\ a_3 \\ a_4 \\ a_5 \\ a_6 \\ a_7 \\ a_8 \end{array} \right] \\ a_i \in [0, 11), *, (5.83, 0); 1 \leq i \leq 8 \end{array} \right.$$

be a special interval super column matrix groupoid of type II.

- (i) Study questions (i) to (viii) of problem 27 for this W.

- (ii) Find all S-units?
- (iii) Find all idempotents which are not S-idempotents of W.

49. Let

$$M = \left\{ \left[\begin{array}{ccccc} a_1 & a_2 & a_3 & a_4 & a_5 \\ a_6 & \dots & \dots & \dots & a_{10} \\ \vdots & \vdots & \vdots & \vdots & \vdots \\ a_{21} & \dots & \dots & \dots & a_{25} \end{array} \right] \mid a_i \in [0, 11), *, (5.83, 0); \right.$$

$1 \leq i \leq 8\}$ be a special interval super column matrix groupoid of type II.

- (i) Find all S-units of M.
- (ii) Find idempotents which are not S-idempotents.
- (iii) Study questions (i) to (viii) of problem 27 for this M.
- (iv) Find all S-zero divisors in M.

50. Let

$$T = \left\{ \left(\begin{array}{c|ccc|cc|c} a_1 & a_2 & a_3 & a_4 & a_5 & a_6 & a_7 \\ a_8 & \dots & \dots & \dots & \dots & \dots & a_{14} \\ a_{15} & \dots & \dots & \dots & \dots & \dots & a_{21} \end{array} \right) \mid a_i \in [0, 27), *, \right.$$

$(25.32, 10); 1 \leq i \leq 21\}$ be a special interval super column matrix groupoid of type II.

- (i) Study questions (i) to (viii) of problem 27 for this T.

- (ii) Find all units of T which are not S-units.
- (iii) Find all S-idempotents of T.
- (iv) Can T have S-zero divisors?

51. Let

$$M = \left(\begin{array}{cccc} a_1 & a_2 & \dots & a_7 \\ a_8 & a_9 & \dots & a_{14} \\ a_{15} & a_{16} & \dots & a_{21} \\ a_{22} & a_{23} & \dots & a_{28} \\ a_{29} & a_{30} & \dots & a_{35} \\ a_{36} & a_{37} & \dots & a_{42} \end{array} \right) \quad a_i \in [0, 24), *, (12.835, 0);$$

$1 \leq i \leq 42$ be a special interval super column matrix groupoid of type II.

- (i) Study questions (i) to (viii) of problem 27 for this M.
- (ii) Find all S-units of M.
- (iii) Find all units of M which are not S-unit.
- (iv) Find all S-idempotents of M.
- (v) Find all zero divisors of M which are not S-zero divisors.

52. Let

$$M = \left\{ \left(\begin{array}{c|ccc|ccc|c} a_1 & a_2 & a_3 & a_4 & a_5 & a_6 & a_7 & \\ \hline a_8 & \dots & \dots & \dots & \dots & \dots & \dots & a_{14} \\ \hline a_{15} & \dots & \dots & \dots & \dots & \dots & \dots & a_{21} \\ \hline a_{22} & \dots & \dots & \dots & \dots & \dots & \dots & a_{28} \\ \hline a_{29} & \dots & \dots & \dots & \dots & \dots & \dots & a_{35} \\ \hline a_{36} & \dots & \dots & \dots & \dots & \dots & \dots & a_{42} \\ \hline a_{43} & \dots & \dots & \dots & \dots & \dots & \dots & a_{49} \end{array} \right) \mid a_i \in [0, 28), *, \right.$$

$(3.7, 4.315); 1 \leq i \leq 49\}$ be a special interval super column matrix groupoid of type II.

- (i) Study questions (i) to (viii) of problem 27 for this T.
- (ii) Find all S-units of M.
- (iii) Find all idempotents of M.
- (iv) Can M have S-zero divisors?

53. Let

$$W = \left\{ \left(\begin{array}{cccc} a_1 & a_2 & \dots & a_{10} \\ \vdots & \vdots & & \vdots \\ a_{91} & a_{92} & \dots & a_{100} \end{array} \right) \mid a_i \in [0, 23), *, (3.5, 3.5); \right.$$

$1 \leq i \leq 100\}$ be a special interval super column matrix groupoid of type II.

- (i) Study questions (i) to (viii) of problem 27 for this W.
- (ii) Is W a commutative groupoid?

- (iii) Can W contain a subgroupoids of finite order?
 - (iv) How many subgroupoids of W of infinite order exist?
 - (v) Can W be normal?
 - (vi) Can W have S-idempotents?
 - (vii) Can W contain infinite number of S-units?
54. Can type II groupoids built using $[0, n)$ satisfy any of the special identities?
 55. Give an example of a type II groupoid which is a S-strong P-groupoid.
 56. Give an example of a type II groupoid using $[0, n)$ which is just a P-groupoid.
 57. Give an example of a type II groupoid which is an idempotents groupoid.
 58. Does there exist a type II groupoid which is a S-strong Bol groupoid?
 59. Does there exist a type II groupoid which is just a S-Bol groupoid and not S-strong Bol groupoid.
 60. Give an example of type II Moufang groupoid.
 61. Let G be a type II groupoid built using $[0, n)$, when will G be a S-strong Bruck groupoid?
 62. Construct a matrix groupoid of type II which is S-strong alternative groupoid.

63. Let $G = \{[0, n), *, (t, u); t, u \in [0, n) \setminus Z_n\}$ be a special interval groupoid of type II.

When will G be a S-right alternative but not S-left alternative.

64. Let $G = \{[0, 27), *, (t, u); t, u \in [0, 27) \setminus Z_{27}\}$ be a special interval groupoid of type II.

Does we have a (s, t) such that G is a S-special strong Bol groupoid?

65. Let

$$M = \left\{ \begin{bmatrix} a_1 & a_2 & a_3 & a_4 \\ \vdots & \vdots & \vdots & \vdots \\ a_{41} & a_{42} & a_{43} & a_{44} \end{bmatrix} \mid a_i \in [0, 29), *, (3.5, 3.5); \right.$$

$1 \leq i \leq 44\}$ be a special interval super column matrix groupoid of type II.

- (i) Study questions (i) to (viii) of problem 27 for this M .
 - (ii) Prove M is commutative.
 - (iii) Can M have subgroupoids of finite order?
 - (iv) Does M satisfy any of the special identities.
66. Let $W = \{[a_1, b_1] \mid a, b \in [0, 25), *, (20, 4.5)\}$ be a special interval super column matrix groupoid of type II.

- (i) Study questions (i) to (viii) of problem 27 for this W .
- (ii) Show W has right ideals which are left ideals for $(45, 20)$.
- (iii) Can W have S-units?

- (iv) Find all idempotents which are not S-idempotents in W .
67. Distinguish between the special interval groupoids of type II and those of special interval groupoids of type II.
68. Let $W_1 = \{[a_1, b_1] \mid a, b \in [0, 17), *, (14.2, 3.8)\}$ and $W_2 = \{[0, 17), *, (14.2, 3.8)\}$ be a special interval groupoid of type II.
- (i) Compare W_1 and W_2 .
- (ii) Show W_1 has subgroupoids isomorphic with W_2 .
- (iii) Can W_1 have S-idempotents?
- (iv) Can W_1 have nilpotent elements?
69. Let $W = \{[a, b] \mid a, b \in [0, 15), *, (7.5, 7.5)\}$ be a special interval super column matrix groupoid of type II.
- Study all the special features associated with M .
70. Let $P = \{[a_1, b_1], [a_2, b_2], \dots, [a_9, b_9] \mid a_i, b_i \in [0, 14), *, (9.5, 4.5)\}$ be a special interval groupoid of type II.
- (i) Study questions (i) to (viii) of problem 27 for this P .
- (ii) Find all S-units of P .
- (iii) Can P have S-idempotents?
- (iv) Does P have zero divisors which are not S-zero Divisors?
- (v) Does P contain a normal subgroupoid of type II?

71. Let

$$M = \left\{ \left[\begin{array}{c} [a_1, b_1] \\ [a_2, b_2] \\ \vdots \\ [a_{10}, b_{10}] \end{array} \right] \mid a_i, b_i \in [0, 11), (5.5, 5.5), *, 1 \leq i \leq 10) \right\}$$

be the special interval groupoid of type II.

Study questions (i) to (v) of problem 70 for this M.

Does M enjoy any other special feature than P in problem 70?

72. Let

$$M_1 = \left\{ \left[\begin{array}{c} [a_1, b_1] \\ [a_2, b_2] \\ \vdots \\ [a_{15}, b_{15}] \end{array} \right] \mid a_i, b_i \in [0, 16), (8.5, 8.5), *, 1 \leq i \leq 15) \right\}$$

be the special interval groupoid of type II.

(i) Study questions (i) to (v) of problem 70 for this M.

(ii) Compare M of 71 with this M_1 .

73. Let $B = \{[a_1, b_1], [a_2, b_2], \dots, [a_8, b_8] \mid a_i, b_i \in [0, 11), *, (10.52, 0)\}$ be a special interval groupoid of type II.

(i) Study questions (i) to (iv) of problem 70 for this B.

(ii) Does B enjoy any other special properties other than this?

74. Let $D = \{[a_1, b_1] \mid [a_2, b_2], [a_3, b_3] \mid [a_4, b_4] [a_5, b_5] [a_6, b_6] \mid [a_7, b_7], [a_8, b_8] [a_9, b_9], [a_{10}, b_{10}] \mid a_i, b_i \in [0, 23), *, (14.37, 14), 1 \leq i \leq 10\}$ be a special interval groupoid of type II.

- (i) Study questions (i) to (vii) of problem 17 for this S.
- (ii) Can D have S-units?
- (iii) Find all S-idempotents of D.
- (iv) Find all S-zero divisors of D.
- (v) Find zero divisors which are not S-zero divisors.

75. Let

$$T = \left\{ \left[\begin{array}{c} [a_1, b_1] \\ [a_2, b_2] \\ [a_3, b_3] \\ [a_4, b_4] \\ [a_5, b_5] \\ [a_6, b_6] \\ [a_7, b_7] \\ [a_8, b_8] \\ [a_9, b_9] \\ [a_{10}, b_{10}] \\ [a_{11}, b_{11}] \\ [a_{12}, b_{12}] \end{array} \right] \mid a_i, b_i \in [0, 9), (6.32, 3), *, 1 \leq i \leq 12) \right\}$$

be the special interval groupoid of type II.

- (i) Study questions (i) to (vii) of problem 27 for this T.
- (ii) Find all units of T which are not S-units of T.

76. Let

$$M = \left\{ \left[\begin{array}{ccc} [a_1, b_1] & [a_2, b_2] & [a_3, b_3] \\ [a_4, b_4] & [a_5, b_5] & [a_6, b_6] \\ \vdots & \vdots & \vdots \\ [a_{19}, b_{19}] & [a_{20}, b_{20}] & [a_{21}, b_{21}] \end{array} \right] \mid a_i, b_i \in [0, 41), \right.$$

$(20.5, 205), *, 1 \leq i \leq 21)$ be the special interval groupoid of type II.

- (i) Study questions (i) to (vii) of problem 27 for this S.
- (ii) Can M have left ideals which are not right ideals?
- (iii) Does M contain ideals?
- (iv) Show M has zero divisors.
- (v) Find all S-units of M.
- (vi) Show M has nilpotent element of order two.

77. Let

$$P = \left\{ \begin{array}{|c|c|c|c|} \hline [a_1, b_1] & [a_2, b_2] & [a_3, b_3] & [a_4, b_4] \\ \hline [a_5, b_5] & \dots & \dots & \dots \\ [a_9, b_9] & \dots & \dots & \dots \\ \hline [a_{13}, b_{13}] & \dots & \dots & \dots \\ [a_{17}, b_{17}] & \dots & \dots & \dots \\ [a_{21}, b_{21}] & \dots & \dots & \dots \\ \hline [a_{25}, b_{25}] & \dots & \dots & \dots \\ \hline \end{array} \right. \quad a_i, b_i \in$$

$$[0, 192), (121.85, 0), *, 1 \leq i \leq 28)$$

be the special interval groupoid of type II.

- (i) Study questions (i) to (viii) of problem 27 for this S.
- (ii) Find all units of P which are not S-units.
- (iii) Find all zero divisors which are not S-zero divisors.
- (iv) Find all idempotents of P which are not S-idempotents.
- (v) Does P satisfy any of the special identities like Bol or Bruck or Moufang?
- (vi) Can P have normal subgroupoids?
- (vii) Can P have a pair of conjugate subgroupoids?
- (viii) Can P have S-ideals?
- (ix) Is P a S-groupoid?
- (x) Is it possible for P have subgroupoids of finite order?

Chapter Four

NON ASSOCIATIVE RINGS AND SEMIRINGS USING THE ALGEBRAIC STRUCTURES BUILT ON $[0, n)$

In this chapter we build non associative semirings and non associative rings using the special interval groupoids of type I and type II.

We find several interesting properties associated with them; however all such semirings as well as rings are of infinite order.

Throughout this chapter Z_n , Z , R , Q and C are rings and $\langle Z_n \cup I \rangle$, $\langle Z \cup I \rangle$, $\langle R \cup I \rangle$, $\langle Q \cup I \rangle$ and $\langle C \cup I \rangle$ are neutrosophic rings.

$Z^+ \cup \{0\}$, $Q^+ \cup \{0\}$ and $R^+ \cup \{0\}$ are all real semirings and $\langle Z^+ \cup \{0\} \cup I \rangle$, $\langle Q^+ \cup \{0\} \cup I \rangle$ and $\langle R^+ \cup \{0\} \cup I \rangle$ are neutrosophic semirings of infinite order.

We can also take lattices L which are distributive lattices and Boolean algebras as semirings.

DEFINITION 4.1: Let $S = \mathbb{Z}^+ \cup \{0\}$ be the semiring.

$G = \{[0, n), *, (t, s); t, s \in \mathbb{Z}_n\}$ be the special interval groupoid of type I.

$$SG = \left\{ \sum_{i=1}^m a_i g_i \mid a_i \in \mathbb{Z}^+ \cup \{0\}; g_i \in G, m < \infty \right\}$$

be the groupoid semiring. Clearly $(SG, +, *)$ is a semiring which is non associative.

- (i) $a \cdot 0 = 0$ where $0 \in G$ and $a \in S$.
- (ii) $1 g_i = g_i$ for all $g_i \in G$.
- (iii) $a g_i = g_i a$ for all $a \in \mathbb{Z}^+ \cup \{0\}$ and $g_i \in G$.

We will first illustrate this situation by some examples before we proceed onto describe their properties.

Example 4.1: Let $S = \mathbb{Z}^+ \cup \{0\}$ be the semiring of integers. $G = \{[0, 5), (2, 3), *\}$ be the special interval groupoid of type I.

$$SG = \left\{ \sum_{i=0}^n a_i g_i \mid n < \infty, a_i \in \mathbb{Z}^+ \cup \{0\}, g_i \in G \right\}$$

be the non associative semiring.

Consider $x = 8 (3.112) + 4 (1.5)$ and
 $y = 3 (2.4) + 7 (0.8) \in SG$.

$$x + y = 8 (3.112) + 4 (1.5) + 3(2.4) + 7 (0.8)$$

$$\begin{aligned} x * y &= (8 (3.112) + 4(1.5)) \times (3 (2.4) + 7 (0.8)) \\ &= 8 \times 3 (3.112 * 2.4) + 8 \times 7 (3.112 * 0.8) + \\ &\quad 4 \times 3 (1.5 * 2.4) + 4 \times 7 (1.5 * 0.8) \\ &= 24 (6.224 + 7.2) + 8 \times 7 (6.224 + 2.4) + \\ &\quad 4 \times 3 (3 + 7.2) + 4 \times 7 (3 + 2.4) \\ &= 24 (3.424) + 56 (3.624) + 12 (0.2) + 28 (0.4) \\ &\quad \in SG. \end{aligned}$$

This is the way the operation addition and multiplication are performed on SG.

Now let $x = 4(2.1) + 2(0.9)$
 $y = 9(0.7)$ and $z = 12(0.3) \in \text{SG}$.

$$\begin{aligned}
 (x * y) * z &= [(4(2.1) + 2(0.9)) * 9(0.7)] * 12(0.3) \\
 &= (4 \times 9(2.1 * 0.7) + 2 \times 9(0.9 * 0.7)) * 12(0.3) \\
 &= (36[4.2 + 2.1] + 18[1.8 + 2.1]) * 12(0.3) \\
 &= [36(1.3) + 18(3.9)] * 12(0.3) \\
 &= 36 \times 12(1.3 * 0.3) + 18 * 12(3.9 * 0.3) \\
 &= 432[2.6 + 0.9] + 216[7.8 + 0.9] \\
 &= 432(3.5) + 216(3.7) \quad \dots \text{ I}
 \end{aligned}$$

Consider

$$\begin{aligned}
 x * (y * z) &= [4(2.1) + 2(0.9)] * (9(0.7) * 12(0.3)) \\
 &= [4(2.1) + 2(0.9)] [9 \times 12(0.7 * 0.3)] \\
 &= [4(2.1) + 2(0.9)] * [108(1.4 + 0.9)] \\
 &= [4(2.1) + 2(0.9)] * 108(2.3) \\
 &= 4 \times 108(2.1 * 2.3) + 2 \times 108(0.9 * 2.3) \\
 &= 432(4.2 + 6.9) + 216(1.8 + 6.9) \\
 &= 432(1.1) + 216(3.7) \quad \dots \text{ II}
 \end{aligned}$$

Clearly I and II are distinct hence SG is non associative thus SG is a non associative semiring.

It is easily verified SG is a non commutative semiring as for
 $x = 3(2.1) + 5(4.1) + 7(0.9)$
and $y = 7(0.5) \in \text{SG}$;

Consider

$$\begin{aligned}
 x * y &= 3(2.1) + 5(4.1) + 7(0.9) * 7(0.5) \\
 &= 3 \times 7(2.1 * 0.5) + 5 \times 7(4.1 * 0.5) + 7 \times 7(0.9 * 0.5) \\
 &= 21(4.2 + 1.5) + 35(8.2 + 1.5) + 49(1.8 + 1.5) \\
 &= 21(0.7) + 35(4.7) + 49(3.3) \quad \dots \text{ I}
 \end{aligned}$$

$$\begin{aligned}
 \text{Now } y * x &= 7(0.5) * (3(2.1) + 5(4.1) + 7(0.9)) \\
 &= 21(0.5 * 2.1) + 35(0.5 * 4.1) + 49(0.5 * 0.9) \\
 &= 21(1.0 + 6.3) + 35(1 + 12.3) + 49(1 + 2.7) \\
 &= 21(2.3) + 35(3.3) + 49(3.7) \quad \dots \text{ II}
 \end{aligned}$$

Clearly I and II are different thus $x * y \neq y * x$ so SG is a non commutative semiring.

$$\begin{aligned}
 \text{Let } x &= 5(2) \text{ and } y = 7(2) \in \text{SG} \\
 x * y &= 5(2) * 7(2) \\
 &= 35(2 * 2) \\
 &= 35(4 + 6) \\
 &= 35.0 \\
 &= 0 \text{ is a zero divisor.}
 \end{aligned}$$

$$\begin{aligned}
 \text{We see } y * x &= 7(2) * 5(2) \\
 &= 35(2 * 2) \\
 &= 0.
 \end{aligned}$$

So SG has zero divisors.

Thus semigroup ring is non associative, non commutative of infinite order and has zero divisors.

Example 4.2: Let $S = \mathbb{Z}^+ \cup \{0\}$ be the semiring of integers. $G = \{[0, 14), (3, 3), *\}$ be the special interval groupoid of type I. SG be the groupoid semiring. SG is non associative but commutative and is of infinite order.

Let $x = 3(2.1) + 8(5.1)$, $y = 4(3) + 2(6.5)$ and $z = 9(3.2) \in \text{SG}$.

$$\begin{aligned}
 (x * y) * z &= [(3(2.1) + 8(5.1)) * (4(3) + \\
 &\quad 2(6.5))] * 9(3.2) \\
 &= [12(2.1 * 3) + 32(5.1 * 3) + 6(2.1 * 6.5) + \\
 &\quad 16(5.1 * 6.5)] * 9(3.2) \\
 &= [12(6.3) + 9) + 32(15.3 + 9) + \\
 &\quad 6(6.3 + 19.5) + 16(15.3 + 19.5)] * 9(3.2) \\
 &= [12(1.3) + 32(10.3) + 6(11.8) + 16(6.8)] * \\
 &\quad 9(3.2) \\
 &= 108(1.3 * 3.2) + 288(10.3 * 3.2) + \\
 &\quad 54(11.8 * 3.2) + 144(6.8 * 3.2) \\
 &= 108(3.9 + 9.6) + 288(30.9 + 9.6) + \\
 &\quad 54(35.4 + 9.6) + 144(20.4 + 9.6)
 \end{aligned}$$

$$\begin{aligned}
 &= 108 (13.5) + 288 (12.5) + 54 (3) + \\
 &\qquad\qquad\qquad 144 (2) \qquad\qquad\qquad \dots \text{ I} \\
 x * (y * z) &= [3 (2.1) + 8 (5.1)] * [4 (3) + 2 (6.5)] \\
 &\qquad\qquad\qquad * 9 (3.2)] \\
 &= [3 (2.1) + 8 (5.1)] * [36 (3 * 3.2) + \\
 &\qquad\qquad\qquad 18 (6.5 * 3.2)] \\
 &= [3 (2.1) + 8 (5.1)] [36 (9 + 9.6) + \\
 &\qquad\qquad\qquad 18 (19.5 + 9.6)] \\
 &= [3 (2.1) + 8 (5.1)] * [36 (4.6) + 18 (1.1)] \\
 &= 108 (2.1 * 4.6) + 288 (5.1 * 4.6) + \\
 &\qquad\qquad\qquad 54 (2.1 * 1.1) + 144 (5.1 * 1.1) \\
 &= 108 (6.3 + 13.8) + 288 (15.3 + 13.8) + \\
 &\qquad\qquad\qquad 54 (6.3 + 3.3) + \\
 &\qquad\qquad\qquad 144 (15.3 + 3.3) \\
 &= 108 (6.1) + 288 (1.1) + 54 (9.6) + \\
 &\qquad\qquad\qquad 144 (4.6) \qquad\qquad\qquad \dots \text{ II}
 \end{aligned}$$

I and II are distinct. So SG is a non associative semiring but SG is commutative.

Example 4.3: Let $S = \mathbb{R}^+ \cup \{0\}$ be the semiring of reals.

$G = \{[0, 10), (6, 4), *\}$ be the special interval groupoid of type I. SG be the groupoid semiring.

Clearly SG is the non associative infinite groupoid semiring.

Let $x = 3 (7.3) + 8\sqrt{3} (4.2)$ and
 $y = 7 (5) + 2 (2.4) \in \text{SG};$

$$\begin{aligned}
 x * y &= [3 (7.3) + 8\sqrt{3} (4.2)] * [7 (5) + 2 (2.4)] \\
 &= 21 (7.3 * 5) + 56\sqrt{3} (4.2 * 5) + 6 (7.3 * 2.4) + \\
 &\qquad\qquad\qquad 16\sqrt{3} (4.2 * 2.4) \\
 &= 21 (43.8 + 20) + 56\sqrt{3} (25.2 + 20) + \\
 &\qquad\qquad\qquad 6 (43.8 + 9.6) + 16\sqrt{3} (25.2 + 9.6)
 \end{aligned}$$

$$= 21 (3.8) + 56\sqrt{3} (5.2) + 6 (3.4) + 16\sqrt{3} (4.8) \dots \quad \text{I}$$

Now

$$\begin{aligned} y * x &= [7 (5) + 2 (2.4)] * [3 (7.3) + 8\sqrt{3} (4.2)] \\ &= 21 (5 * 7.3) + 6 (2.4 * 7.3) + 56\sqrt{3} (5 * 4.2) + \\ &\quad 16\sqrt{3} (2.4 * 4.2) \\ &= 21 (30 + 29.2) + 6 (14.4 + 29.2) + \\ &\quad 56\sqrt{3} (30 + 16.8) + 16\sqrt{3} (14.4 + 16.8) \\ &= 21 (9.2) + 6 (3.6) + 56\sqrt{3} (6.8) + 16\sqrt{3} (1.2) \dots \quad \text{II} \end{aligned}$$

I and II are distinct. So SG is non commutative.

Consider $x = 4 (3.8) + 3 (5.2)$, $y = 8(4.8)$ and $z = 16 (2.5) \in \text{SG}$

$$\begin{aligned} (x * y) * z &= [(4 (3.8) + 3 (5.2)) * 8(4.8)] * 16 (2.5) \\ &= [32 (22.8 + 19.2) + 24 (31.2 + 19.2)] * 16 (2.5) \\ &= [32 (2) + 24 (0.4)] * 16 (2.5) \\ &= 512 (2 * 2.5) + 384 (0.4 \times 2.5) \\ &= 512 (16 + 10.0) + 384 (2.4 + 10.0) \\ &= 512 (6) + 384 (2.4) \dots \quad \text{I} \end{aligned}$$

$$\begin{aligned} x * (y * z) &= [4 (3.8) + 3 (5.2)] * [8(4.8) * 16 (2.5)] \\ &= [4 (3.8) + 3 (5.2)] [128 (4.8 + 2.5)] \\ &= [4 (3.8) + 3(5.2)] * [128 (28.8 + 10.0)] \\ &= [4 (3.8) + 3(5.2)] * 128 (8.8) \\ &= 4 \times 128 (3.8 * 8.8) + 3 \times 128 (5.2 \times 8.8) \\ &= 512 (22.8 + 35.2) + 384 (31.2 + 35.2) \\ &= 512 (8) + 384 (6.4) \dots \quad \text{II} \end{aligned}$$

I and II are not identical.

Thus SG is non associative.

Example 4.4: Let $S = \mathbb{Q}^+ \cup \{0\}$ be the semiring.

$G = \{[0, 12), (4, 8), *\}$ be the special interval groupoid of type I. Let SG be the groupoid semiring which is non associative and of infinite order.

Let $x = 3(6.8) + 4(5.6)$, $y = 8(3.3) + 2(6)$ and $z = 4(10) \in SG$.

We find

$$\begin{aligned}
 (x * y) * z &= [3(6.8) + 4(5.6)] * [8(3.3) + 2(6)] * 4(10) \\
 &= [24(6.8 * 3.3) + 32(5.6 * 3.3) + 6(6.8 * 6) + \\
 &\quad 8(5.6 * 6)] * 4(10) \\
 &= [24(27.2 + 26.4) + 32(22.4 + 26.4) + \\
 &\quad 6(27.2 + 48) + 8(22.4 + 48)] * 4(10) \\
 &= 24(5.6) + 32(0.8) + 6 \times 3.2 + \\
 &\quad 8(10.4)] * 4(10) \\
 &= 24 \times 4(5.6 * 10) + 128(0.8 * 10) + \\
 &\quad 6 \times 4(3.2 * 10) + 8 \times 4(10.4 * 10) \\
 &= 96[22.4 + 80] + 128[3.2 + 80] + \\
 &\quad 24(12.8 + 80) + 32(41.6 + 80) \\
 &= 96(6.4) + 128(11.2) + 24(8.8) + 32(1.6) \\
 &\quad \dots \text{ I}
 \end{aligned}$$

$$\begin{aligned}
 x * (y * z) &= x * [(8(3.3) + 2(6)) * 4(10)] \\
 &= x * [32(3.3 * 10) + 8(6 * 10)] \\
 &= x * [32(13.2 + 80) + 8(24 + 80)] \\
 &= x * [32(9.2) + 8(8)] \\
 &= [3(6.8) + 4(5.6)] * [32(9.2) + 8(8)] \\
 &= 96[6.8 * 9.2) + 128(5.6 * 9.2) + 24(6.8 * 8) + \\
 &\quad 32(5.6 * 8) \\
 &= 96(27.2 + 73.6) + 128(22.4 + 73.6) + 24(27.2 + 64) + \\
 &\quad 32(22.4 + 64) \\
 &= 96(4.8) + 128(0) + 24(7.2) + 32(2.4) \quad \dots \text{ II}
 \end{aligned}$$

I and II are distinct. Hence SG is a non commutative and non associative semiring of infinite order.

However SG has zero divisors.

$$\begin{aligned}
 &\text{Take } x = 9(6) + 3(3) \text{ and } y = 15(3) + 10(6) \in SG \\
 x \times y &= [9(6) + 3(3)] \times [15(3) + 10(6)] \\
 &= 9 \times 15(6 * 3) + 3 \times 15(3 * 3) + 90(6 * 6) + \\
 &\quad 30(3 * 6) \\
 &= 135(24 + 24) + 45(12 + 24) + 90(24 + 48) + \\
 &\quad 30(12 + 48) \\
 &= 135 \times 0 + 45 \times 0 + 90 \times 0 + 30 \times 0 \\
 &= 0.
 \end{aligned}$$

Thus $x * y = 0$ is a zero divisor in SG infact SG has infinite number of zero divisors.

Example 4.5: Let $S = L = C_{20}$ be a chain lattice.



and $G = \{[0, 24), *, (10, 10)\}$ be the special interval groupoid of type I. LG be the groupoid lattice or the groupoid semiring. Then LG is a commutative semiring of infinite order.

$$\begin{aligned}
 &\text{Let } x = a_1 20 + a_2 5 + a_6 7, y = a_4 9 \text{ and} \\
 &z = a_9 3 + a_8 4.1 \in SG = LG.
 \end{aligned}$$

$$\begin{aligned}
 &\text{We find } (x * y) * z \\
 &= [(a_1 20 + a_2 5 + a_6 7) * (a_4 9)] * z \\
 &= [a_1 a_4 (20 * 9) + a_2 a_4 (5 * 9) + a_6 a_4 (7 * 9)] * z \\
 &= [a_4 (200 + 90) + a_4 (50 + 90) + a_6 (70 + 90)] * \\
 &\quad (a_9 3 + a_8 4.1)
 \end{aligned}$$

$$\begin{aligned}
 &= [a_4 (2) + a_4 (20) + a_6 (16)] * (a_9 3 + a_8 4.1) \\
 &= a_4 a_9 (2 * 3) + a_4 a_9 (20 * 3) + a_6 \times a_9 (16 * 3) + \\
 &\quad a_4 a_8 (2 * 4.1) + a_4 a_8 (20 * 4.1) + a_6 a_8 (16 * 4.1) \\
 &= a_9 (20 + 30) + a_9 (200 + 30) + a_9 (160 + 30) + \\
 &\quad a_8 (20 + 41) + a_8 (200 + 41) + a_8 (16 + 41) \\
 &= a_9 2 + a_9 14 + a_9 22 + a_8 13 + a_8 (1) + a_8 (9) \quad \dots \text{ I}
 \end{aligned}$$

$$\begin{aligned}
 x * (y * z) &= ((a_1 20 + a_2 5 + a_6 (7)) * [(a_4 9) * \\
 &\quad (a_9 3 + a_8 4.1)]) \\
 &= (a_1 20 + a_2 5 + a_6 7) [a_4 a_9 9 * 3 + a_4 a_8 9 * \\
 &\quad 4.1] \\
 &= (a_1 20 + a_2 5 + a_6 7) [(a_9 (90 + 30) + \\
 &\quad a_8 (90 + 41))] \\
 &= (a_1 20 + a_2 5 + a_6 7) * (a_9 0 + a_8 11) \\
 &= (a_1 20 + a_2 5 + a_6 7) * a_8 11 \\
 &= a_1 a_8 20 * 11 + a_2 a_8 5 * 11 + a_6 a_8 7 * 11 \\
 &= a_8 (200 + 110) + a_8 (50 + 110) + a_8 (70 + 110) \\
 &= a_8 22 + a_8 16 + a_8 12 \quad \dots \text{ I}
 \end{aligned}$$

$$\begin{aligned}
 (x * y) * z &= [(a_1 20 + a_2 5 + a_6 7) * (a_4 9)] * \\
 &\quad (a_9 3 + a_8 4.1) \\
 &= [a_1 a_4 (20 * 9) + a_2 a_4 (5 * 9) + a_6 a_4 (7 * 9)] [a_9 3 + a_8 4.1] \\
 &= [a_4 (200 + 90) + a_4 (50 + 90) + a_6 (70 + 90)] * \\
 &\quad (a_9 3 + a_8 4.1) \\
 &= (a_4 2 + a_4 20 + a_6 16) (a_9 3 + a_8 4.1) \\
 &= a_4 a_9 (2 * 3) + a_4 a_9 (20 * 3) + a_6 a_8 (16 * 4.1) \\
 &= a_9 (20 + 30) + a_9 (200 + 30) + a_8 (160 + 41) \\
 &= a_9 2 + a_9 14 + a_8 9 \quad \dots \text{ II}
 \end{aligned}$$

I and II are distinct hence SG is a non associative semiring.

Let $x = a_6 12$ and $y = a_8 6 \in SG$

$$\begin{aligned}
 x * y &= a_6 12 * a_8 12 \\
 &= a_6 a_8 (12 * 12) \\
 &= a_8 (120 + 120) \\
 &= 0 \text{ is a zero divisor in SG.}
 \end{aligned}$$

Example 4.6: Let $S =$

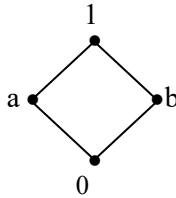

be the semiring which is a Boolean algebra of order two.

$G = \{[0, 9), (6, 3), *\}$ be the special interval groupoid of type I.

SG be the groupoid semiring of the groupoid G over the semiring S . SG has zero divisors.

Let $x = a3 + b3 + a6$ and $y = b6 + a3 \in SG$.

$$\begin{aligned}
 x * y &= (a3 + b3 + a6) * (b6 + a3) \\
 &= ab(3 * 6) + bb(3 * 6) + ab(6 * 6) + aa(3 * 3) + \\
 &\quad ba(3 * 3) + aa(6 * 3) \\
 &= 0 + b(18+18) + 0(6 * 6) + a(18 + 9) + 0 + \\
 &\quad aa(6 \times 6 + 3 \times 3) \\
 &= 0.
 \end{aligned}$$

$$x * y = 0.$$

Thus SG has zero divisors.

SG is non commutative and a non associative semiring.

Suppose $x = a 0.9 + b 5.2$ and $y = a7 + 0.3 \in SG$.

$$\begin{aligned}
 x * y &= (a 0.9 + b 5.2) * (a7 + 0.3) \\
 &= a.a(0.9 * 7) + ba(5.2 * 7) + a.1(0.9* 0.3) \\
 &\quad + b.1(5.2 * 0.3) \\
 &= a(5.4 + 21) + b(31.2 + 0.9) + a(5.4 + 0.9) \\
 &= a(8.4) + b(5.1) + a(6.3) \quad \dots \quad I \in SG.
 \end{aligned}$$

Consider $y * x = (a7 + 0.3) * (a.0.9 + b 5.2)$

$$\begin{aligned}
 &= aa(7 * 0.9) + a.1(0.3 * 0.9) + a.b(7 * 5.2) + \\
 &\quad 1.b(0.3 * 5.2) \\
 &= a(42 + 2.7) + a(1.8 + 2.7) + 0 + b(1.8 + 15.6) \\
 &= a8.7 + a 4.5 + b 8.4 \qquad \dots \text{ II}
 \end{aligned}$$

Clearly I and II are distinct; hence SG is a non commutative semiring.

Consider $x = a(3.8)$, $y = (1.8)$, and $z = a(5) \in SG$.

$$\begin{aligned}
 (x * y) * z &= [a(3.8) * (1.8)] \times a(5) \\
 &= a(3.8 * 1.8) \times a(5) \\
 &= a(22.8 + 5.4) * a(5) \\
 &= a(1.2) * a(5) \\
 &= a(1.2 * 5) \\
 &= a(7.2 + 15) \\
 &= a(4.2) \qquad \dots \text{ I}
 \end{aligned}$$

$$\begin{aligned}
 x * (y * z) &= a(3.8) \times [1.8 \times a(5)] \\
 &= a(3.8) \times [a(10.8 + 15)] \\
 &= a(3.8) \times a(7.8) \\
 &= a(3.8 \times 6 + 7.8 \times 3) \\
 &= a(22.8 + 23.4) \\
 &= a(1.2) \qquad \dots \text{ II}
 \end{aligned}$$

Clearly I and II are distinct, hence SG is a non associative semiring which has zero divisors.

Example 4.7: Let $S =$

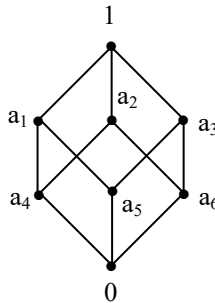

be a semiring which is a Boolean algebra of order 8.

$G = \{[0, 12), *, (4, 8)\}$ be a special interval groupoid of type I. SG be the groupoid semiring of the groupoid G over the semiring S.

Now SG has zero divisors and idempotents.

For $x = a_1 4$, $y = a_2 4$ and $z = a_3 9$ are all such that $x * x = 0$, $y * y = 0$ and $z * z = 0$ so they are nilpotents of order two and are zero divisors in SG.

Let $x = a_1 3.2 + a_2 4.5 + a_3 7.1$ and $y = a_4 5.8$ and $z = a_6 3.5 \in SG$.

$$\begin{aligned} (x * y) * z &= [(a_1 3.2 + a_2 4.5 + a_3 7.1) * a_4 5.8] * a_6 3.5 \\ &= [a_1 a_4 (3.2 * 5.8) + a_2 a_4 (4.5 * 5.8) + a_3 a_4 (7.1 * 5.8)] * a_6 3.5 \\ &= [a_4 (12.8 + 46.4) + a_4 (18 + 46.4) + 0] * a_6 3.5 \\ &= (a_4 (11.2) + a_4 (4.4)) (a_6 3.5) \\ &= a_4 a_6 (11.2 * 3.5) + a_4 a_6 (4.4 * 3.5) \\ &= 0 \end{aligned} \quad \dots \text{ I}$$

Consider

$$\begin{aligned} x * (y * z) &= x * [a_4 5.8 * a_6 3.5] \\ &= x * 0 \\ &= 0. \end{aligned} \quad \dots \text{ II}$$

I and II are identical therefore this triple is associative.

Let $x = a_1 10$, $y = a_4 9$ and $z = a_2 3.5 \in SG$

$$\begin{aligned} \text{Consider } (x * y) * z &= (a_1 10 * a_4 9) * z \\ &= a_1 a_4 (10 * 9) * z \\ &= a_4 (40 + 72) * a_2 3.5 \\ &= a_4 6 * a_2 3.5 \\ &= a_4 a_2 (6 * 3.5) \\ &= a_4 (24 + 28.0) \\ &= a_4 4 \end{aligned} \quad \dots \text{ I}$$

$$\begin{aligned}
 \text{Now } x * (y * z) &= x * (a_4 9 * a_2 3.5) \\
 &= x * (a_4 a_2 (9 * 3.5)) \\
 &= x * (a_4 (36 + 28.0)) \\
 &= a_1 10 * a_4 4 \\
 &= a_4 (10 * 4) \\
 &= a_4 (40 + 32) \\
 &= 0 \qquad \qquad \qquad \dots \qquad \text{II}
 \end{aligned}$$

Clearly I and II are distinct hence SG is a non associative semiring. SG has zero divisors.

SG also has subsemirings of infinite order as well as finite order.

Example 4.8: Let $M = \left\{ \sum_{i=0}^n a_i x^i \mid a_i \in L = \right.$

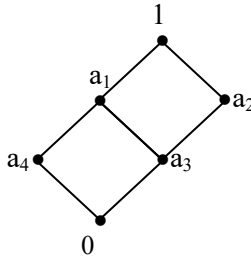

and $x_i \in G = \{[0, 6), *, (3, 2)\} \ n < \infty\}$; MG be the groupoid semiring of infinite order.

M has zero divisors. M is a non associative semiring. M has subsemirings of finite order also.

Take $T = \left\{ \sum_{i=0}^n a_i x^i \mid a_i \in L \text{ and } x_i \in H = \{Z_6, *, (3, 2)\} \right\} \subseteq$

M; T is a non associative semiring of finite order and has zero divisors and units M has also infinite order non associative subsemirings.

Example 4.9: Let $S =$

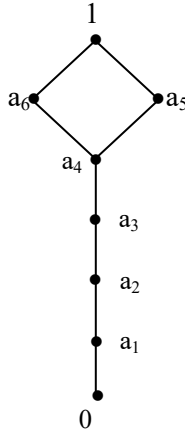

be the distributive lattice $G = \{[0, 120); *, (3, 12)\}$ be the special interval groupoid of type I. SG be the groupoid semiring of infinite order.

SG is non associative and non commutative semiring.
 SG has subsemirings.

Example 4.10: Let $S =$

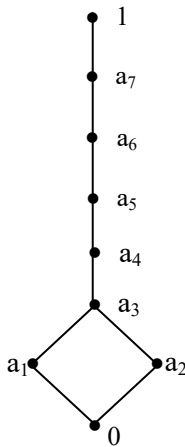

be the distributive lattice (a semiring) and $G = \{[0, 16), *, (5, 7)\}$ be the special interval groupoid. SG be the groupoid semiring of infinite order.

Example 4.11: Let $S = \{L = L_1 \times L_2 \text{ where } L_1$

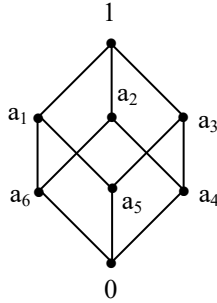

and $L_2 =$

be the semiring.

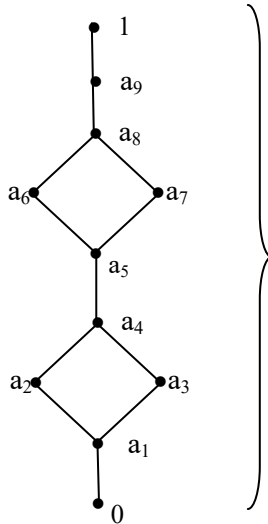

and $G = \{[0, 15), *, (7, 8)\}$ be the special interval groupoid of type I. SG be the groupoid semiring.

Clearly SG is of infinite order and is non commutative and non associative.

Let $x = (0, a_2) 3 + (0, a_3) 5$ and $y = (0, a_4) 3.1 \in SG$.

$$\begin{aligned}
 x \times y &= [(0, a_2) 3 + (0, a_3) 5] \times (0, a_4) 3.1 \\
 &= (0, a_2) (0, a_4) (3 * 3.1) + (0, a_3) (0, a_4) (5 * 3.1) \\
 &= (0, a_2) (21 + 24.8) + (0, a_3) (a_4) (5 * 3.1) \\
 &= (0, a_2) (21 + 24.8) + (0, a_3) (35 + 24.8) \\
 &= (0, a_2) (0.8) + (0, a_3) (14.8) \quad \dots \text{ I}
 \end{aligned}$$

$$\begin{aligned}
 \text{Consider } y \times x &= (0, a_4) 3.1 \times [(0, a_2) 3 + (0, a_3) 5] \\
 &= (0, a_4) (0, a_2) (3.1 * 3) + (0, a_4) (0, a_3) (3.1 * 5) \\
 &= (0, a_2) (21.7 + 24) (0, a_3) (21.7 + 40) \\
 &= (0, a_2) (0.7) + (0, a_3) (1.7) \quad \dots \text{ II}
 \end{aligned}$$

I and II are distinct so SG is non commutative.

Consider $x = (0, a_4) 0.7$, $y = (0, a_3) 7$ and $z = (0, a_2) 4.5 \in SG$

$$\begin{aligned}
 (x * y) * z &= ((0, a_4) 0.7 * (0, a_3) 7) * (0, a_2) 4.5 \\
 &= (0, a_4) (0, a_3) (0.7 * 7) * (0, a_2) 4.5 \\
 &= (0, a_3) (0.7 \times 7 + 7 \times 8) \times (0, a_2) 4.5 \\
 &= (0, a_3) (4.9 + 56) * (0, a_2) 4.5 \\
 &= (0, a_3) (0.9) * (0, a_2) 4.5 \\
 &= (0, a_3) (0, a_2) (0.9 * 4.5) \\
 &= (0, a_1) (0.9 \times 7 + 4.5 \times 8) \\
 &= (0, a_1) (6.3 + 36.0) \\
 &= (0, a_1) 12.3 \quad \dots \text{ I}
 \end{aligned}$$

$$\begin{aligned}
 \text{Now } x * (y * z) &= x * ((0, a_3) 7 * (0, a_2) 4.5) \\
 &= x * (0, a_1) (49 + 36.0) \\
 &= (0, a_4) 0.7 * (0, a_1) 10 \\
 &= (0, a_1) (4.9 + 80) \\
 &= (0, a_1) 9.9 \quad \dots \text{ II}
 \end{aligned}$$

I and II are distinct so SG is a non associative semiring.

Example 4.12: Let $S =$

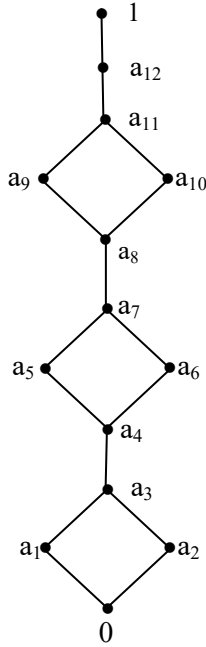

be the semiring. $G = \{[0, 10), *, (0, 5)\}$ be the special interval groupoid of type I.

SG be the groupoid semiring. Clearly SG is a non commutative and non associative semiring. SG has zero divisors and idempotents.

Let $x = a_4 5 + a_6 2 + a_9 6$, $y = a_8 8$ and $z = a_3 5 \in SG$.

$$\begin{aligned}
 (x * y) * z &= ((a_4 5 + a_6 2 + a_9 6) * a_8 8) * a_3 5 \\
 &= [a_4 a_8 (5 * 8) + a_6 a_8 (2 * 8) + a_9 a_8 (6 * 8)] * a_3 5 \\
 &= [a_4 [5 \times 0 + 8 \times 5] + a_6 (2 \times 0 + 8 \times 5) + \\
 &\quad a_8 (6 \times 0 + 8 \times 5)] * a_3 5 \\
 &= 0 \qquad \dots \text{ I}
 \end{aligned}$$

$$\begin{aligned}
 x * (y * z) &= (a_4 5 + a_6 2 + a_9 6) * [a_8 8 * a_3 5] \\
 &= (a_4 5 + a_6 2 + a_9 6) [a_8 a_3 (8 * 5)] \\
 &= (a_4 5 + a_6 2 + a_9 6) * (a_3 5) \\
 &= a_4 a_3 (5 * 5) + a_6 a_3 (2 * 5) + a_9 a_3 (6 * 5) \\
 &= a_3 5 + a_3 5 + a_3 5 \\
 &= a_3 5 \qquad \dots \text{ II}
 \end{aligned}$$

I and II are distinct, so in general SG is a non associative semiring.

Example 4.13: Let $S = L_1 \times L_2 \times L_3$ where $L_1 =$

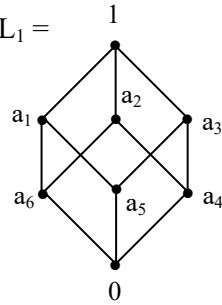

and

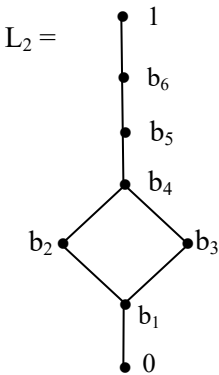

and $L_3 =$

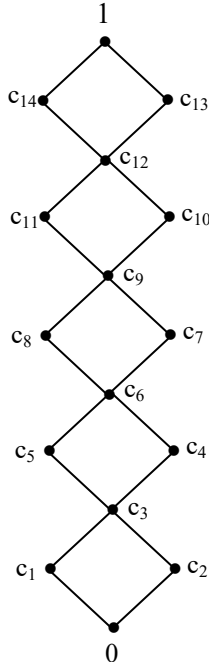

be a semiring. $G = \{[0, 17], *, (8, 16)\}$ be the special interval groupoid of infinite order. SG be the groupoid semiring of the groupoid G over the semiring S . Thus SG is a non commutative semiring and has zero divisors.

Example 4.14: Let $S = \{[0, 5], *, \min, \max\}$ be a semiring of infinite order. $G = \{[0, 9], *, (4, 5)\}$ be the special interval groupoid of infinite order. SG be the infinite groupoid semiring of the groupoid G over the semiring S .

Let $x = 0.72 (3.2) + 0.46 (4.3)$ and
 $y = 0.97 (6.3) + 3.27 (5) \in SG$.

$$x + y = 0.72 (3.2) + 0.46 (4.3) + 0.97 (6.3) + 3.27 (5) \in SG$$

$$x \times y = [0.72 (3.2) + 0.46 (4.3)] \times [0.97 (6.3) + 3.27 (5)]$$

$$= \min \{0.72, 0.97\} (3.2 * 6.3) + \min \{0.46, 0.97\} (4.3 * 6.3) + \min \{0.72, 3.27\} (3.2 * 5) + \min \{0.46, 3.27\} (4.3 * 5)$$

$$= 0.72 \{3.2 \times 4 + 6.3 \times 5\} + 0.46 \{4.3 \times 4 + 6.3 \times 5\} + 0.72 \{3.2 \times 4 + 5 \times 5\} + 0.46 \{4.3 \times 4 + 5 \times 5\}$$

$$= 0.72 (12.8 + 31.5) + 0.46 (17.2 + 31.5) + 0.72 (12.8 + 25) + 0.46 (17.2 + 2.5)$$

$$= 0.72 (8.3) + 0.46 (3.7) + 0.72 (1.8) + 0.46 (1.7) \quad \dots \text{ I}$$

Consider

$$y \times x = [0.92 (6.3) + 3.27 (5)] \times (0.72 (3.2) + 0.46 (4.3))$$

$$= \min \{0.92, 0.72\} (6.3 * 3.2) + \min [3.27, 0.72] \times (5 * 3.2) + \min \{0.92, 0.46\} (6.3 * 4.3) + \min \{3.27, 0.46\} (5 * 4.3)$$

$$= 0.72 (6.3 \times 4 + 3.2 \times 5) + 0.72 (5 \times 4 + 3.2 \times 5) + 0.46 (6.3 \times 4 + 4.3 \times 5) + 0.46 (5 \times 4 + 5 \times 4.3)$$

$$\begin{aligned}
 &= 0.72 (25.2 + 16.0) + 0.72 (20 + 16.0) + \\
 &\quad 0.46 (25.2 + 21.5) + 0.46 (20 + 21.5) \\
 &= 0.72 (5.2) + 0.72 (0) + 0.46 (1.7) + 0.46 (5.5) \\
 &\qquad\qquad\qquad \dots \qquad \text{II}
 \end{aligned}$$

Clearly I and II are distinct hence SG is a non commutative groupoid of type I.

Example 4.15: Let $S = \{[0, 20), \min, \max\}$ be a special interval semiring of infinite order.

Let $G = \{[0, 5), *, (2, 0)\}$ be the special interval groupoid of type I of infinite order.

SG be the groupoid semiring of infinite order.

$$\begin{aligned}
 \text{Let } x &= 6.4 (2.5) + 9 (1.5) \\
 y &= 8 (3.5) \text{ and } z = 7 (4.3) \in \text{SG}.
 \end{aligned}$$

$$\begin{aligned}
 (x * y) * z &= \{[6.4 (2.5) + 9 (1.5)] * 8 (3.5)\} * 7 (4.3) \\
 &= \min \{6.4, 8\} (2.5 * 3.5) + \min \{9, 8\} (1.5 * 3.5) * 7 (4.3) \\
 &= [6.4 (2.5 \times 2 + 3.5 \times 0) + 8 (2 \times 1.5 + 3.5 \times 0)] * 7 (4.3) \\
 &= [6.4 (0) + 8 (3)] * 7 (4.3) \\
 &= 8 (3) * 7 (4.3) \\
 &= \min \{8, 7\} (3 \times 2 + 4.3 \times 0) \\
 &= 7 (1) \qquad\qquad\qquad \dots \text{ I}
 \end{aligned}$$

$$\begin{aligned}
 x * (y * z) &= [6.4 (2.5) + 9 (1.5)] * (8 (3.5) * 7 (4.3)) \\
 &= [6.4 (2.5) + 9 (1.5)] * \min \{8, 7\} (2 \times 3.5 + 4.3 \times 0) \\
 &= [6.4 (2.5) + 9 (1.5)] * 7 (2) \\
 &= \min \{6.4, 7\} (2.5 \times 2 + 2 \times 0) + \min \{9, 7\} \\
 &\quad (1.5 \times 2 + 2 \times 0) \\
 &= 6.4 (0) + 7 (3) \\
 &= 7 (3) \qquad\qquad\qquad \dots \text{ II}
 \end{aligned}$$

I and II are distinct so the groupoid semiring is non associative and non commutative.

Let $x = 19 (3.5) + 17 (3.3) + 4 (3.2)$ and
 $y = 12 (4.1) + 7 (0.5) \in SG$

$$\begin{aligned}
 x * y &= (19 (3.5) + 17 (3.3) + 4 (3.2)) * (12 (4.1) + 7 (0.56)) \\
 &= \min \{19, 12\} (3.5 * 4.1) + \min \{17, 12\} (3.3 * 4.1) + \min \{4, 12\} (3.2 * 4.1) + \\
 &\quad \min \{19, 7\} (3.5 * 0.5) + \min \{17, 7\} (3.3 * 0.5) + \min \{4, 7\} (3.2 * 0.5) \\
 &= 12 (3.5 \times 2 + 4.1 \times 0) + 12 (3.3 \times 2 + 0) + 4 (3.2 \times 2 + 0) + 7 (3.5 \times 2 + 0) + \\
 &\quad 7 (3.3 \times 2 + 0) + 4 (3.2 \times 2 + 0) \\
 &= 12 (2) + 12 (1.6) + 7 (1.6) + 4 (1.4) + 7(2) \\
 &= 12 (2) + 4 (1.4) + 12 (1.6) \quad \dots I
 \end{aligned}$$

Consider

$$\begin{aligned}
 y * x &= (12 (4.1) + 7 (0.5)) * (19 (3.5) + 17 (3.3) + 4 (3.2)) \\
 &= \min \{12, 19\} (4.1 * 3.5) + \min \{7, 19\} (0.5 * 3.5) + \min \{12, 17\} (4.1 \times 3.3) + \min \{7, 17\} (0.5 \times 3.3) + \min \{12, 4\} (4.1 \times 3.2) + \min \{7, 4\} (0.5 \times 3.2) \\
 &= 12 (4.1 \times 2 + 3.5 \times 0) + 7 (0.5 \times 2 + 3.5 \times 0) + 12 (4.1 \times 2 + 3.3 \times 0) + 7 (0.5 \times 2 + 3.3 \times 0) + 4 (4.1 \times 2 + 0) + 4 (0.5 \times 2 + 0) \\
 &= 12 (3.2) + 7 (1) + 12 (3.2) + 7 (1) + 4 (3.2) + 4 (1) \\
 &= 12 (3.2) + 7 (1) \quad \dots II
 \end{aligned}$$

I and II are distinct so this groupoid semiring is non commutative.

Now we call those groupoid semirings in which both the groupoid and semiring are built using the interval $[0, n)$ as strong special interval groupoid semirings.

We give some more examples of them.

Example 4.16: Let $S = \{[0, 7), \min, \max\}$ be the special interval semiring of infinite order. $G = \{[0, 7), *, (4.3)\}$ be the special interval groupoid of type I.

SG be the groupoid semiring. SG is non commutative and is of infinite order.

Example 4.17: Let $S = \{[0, 10), \min, \max\}$ be the special interval semiring and $G = \{[0, 10), *, (5, 5)\}$ be special interval groupoid of type I; let SG be the special interval strong groupoid semiring.

Clearly SG is a commutative semiring of infinite order. SG is non associative for if

$$x = 3.5 (7) + 8 (3.4) + 2 (2.2)$$

$$y = 2.5 (2.4) + 3.7 (5.8) \text{ and } z = 9.5 (7.4) \in SG; \text{ we find}$$

$$\begin{aligned} (x * y) * z &= \{[3.5 (7) + 8 (3.4) + 2 (2.2)] * (2.5 (2.4) + 3.7 (5.8))\} * 9.5 (7.4) \\ &= \{\min \{3.5, 2.5\} (7 * 2.4) + \min \{3.5, 3.7\} (7 * 5.8) + \min \{8, 2.5\} (3.4 * 2.4) + \min \{8, 3.7\} (3.4 * 5.8) + \min \{2, 2.5\} (2.2 * 2.4) + \min \{2, 3.7\} (2.2 * 5.8)\} * 9.5 (7.4) \\ &= \{2.5 (35 + 12.0) + 3.5 (7 \times 5 + 29.0) + 2.5 (17.0 + 12.0) + 3.7 (17.0 + 29.0) + 2 (11.0 + 12.0) + 2 (11.0 + 29.0)\} * 9.5 (7.4) \\ &= \{2.5 (7) + 3.5 (4) + 2.5 (9) + 3.7 (6) + 2 (3) + 2(0)\} * (9.5 (7.4)) \\ &= \min \{2.5, 9.5\} (7 * 7.4) + \min \{3.5, 9.5\} (4 * 7.4) + \min \{2.5, 9.5\} (9 * 7.4) + \min \{3.7, 9.5\} (6 * 7.4) + \min \{2, 9.5\} (3 * 7.4) + \min \{2, 9.5\} (0 * 7.4) \end{aligned}$$

$$\begin{aligned}
 &= 2.5 (35 + 37.0) + 3.5 (20 + 37.0) + \\
 &\quad 2.5 \{45 + 37.0\} + 3.7 \{30 + 37.0\} + \\
 &\quad 2 \{15 + 37.0\} + 2 (0 + 37.0) \\
 &= 2.5 (2) + 3.5 (2) + 2.5 (2) + 3.7 (7) + 2 (2) + 2(2) \\
 &= 3.5 (2) + 3.7 (7) \qquad \dots \text{ I}
 \end{aligned}$$

$$\begin{aligned}
 x * (y * z) &= [3.5 (7) + 8 (3.4) + 2 (2.2)] * (2.5 (2.4) + \\
 &\quad 3.7 (5.8)) * 9.5 (7.4) \\
 &= [3.5 (7) + 8 (3.4) + 2 (2.2)] * \{\min \{2.5, 9.5\} \\
 &\quad (2.4 * 7.4) + \min \{3.7, 9.5\} (5.8 * 7.4)\} \\
 &= [3.5 (7) + 8 (3.4) + 2(2.2)] * \{2.5 (12 + 37.0) \\
 &\quad + 3.7 (29.0 + 37.0)\} \\
 &= \{[3.5 (7) + 8 (3.4) + 2 (2.2)] * [2.5 (9) + \\
 &\quad 3.7 (6)]\} \\
 &= \min \{3.5, 2.5\} (7 * 9) + \min \{8, 2.5\} (3.4 * 9) \\
 &\quad + \min \{2, 2.5\} (2.2 * 9) + \\
 &\quad \min \{3.5, 3.7\} (7 * 6) + \\
 &\quad \min \{8, 3.7\}(3.4 * 6) + \min \{2, 3.7\} \\
 &\quad (2.2 * 6) \\
 &= 2.5 (35 + 45) + 2.5 (17.0 + 45) + 2 (11 + 45) \\
 &\quad + 3.5 (35 + 30) + 3.7 (17.0 + 30) + \\
 &\quad 2 (10.0 + 30) \\
 &= 2.5 (0) + 2.5 (2) + 2(6) + 3.5 (5) + 3.7 (7) + \\
 &\quad 2 (0) \qquad \dots \text{ II}
 \end{aligned}$$

Clearly I and II are distinct and SG is a strong special interval groupoid semiring which is commutative and is of infinite order.

Example 4.18: Let $S = \{[0, 26), \min, \max\}$ be the strong special semiring. $G = \{[0, 13), (6, 0), *\}$ be the special interval groupoid of type I. SG be the strong special interval groupoid semiring of infinite order.

Clearly SG is both non associative and non commutative.

Now we can define substructures in case of these non associative semirings built using interval groupoids of type I.

We will illustrate this by some examples.

Example 4.19: Let $S = \{[0, 19), \min, \max\}$ be the semiring. $G = \{[0, 12), *, (6, 6)\}$ be the special interval groupoid of type I. SG be the groupoid semiring of the groupoid G over the semiring S . PH where $P = \{Z_{19}, \min, \max\}$ be the subsemiring.

$H = \{0, 2, 4, 6, 8, 10\} \subseteq G$ be the subgroupoid of G . PH is a special interval subgroupoid of finite order. Infact PH is not an ideal of SG .

Example 4.20: Let $S = \{[0, 40)\}$ be the special interval semiring under max and min. $G = \{[0, 24), *, (12, 8)\}$ be the special interval groupoid of type I. SG be the strong special interval groupoid semiring of infinite order.

Let $P = \{[0, 20) \subseteq [0, 40) = S\}$ be the special interval subsemiring under max and min.

$H = \{0, 1, 2, \dots, 23\} \subseteq [0, 24)$ be the subgroupoid of G . PH be the subgroupoid subsemiring of H over the subsemiring.

Clearly PH is of finite order and PH is not an ideal of SG .

Example 4.21: Let $G = \{[0, 32), *, (16, 8)\}$ be the special interval groupoid of type I and $S = \{[0, 16), \min, \max\}$ be the semiring. SG be the groupoid semiring.

Let $B = \{\{0, 2, 4, 6, 8, 10, 12, 14, \dots, 30\}\} \subseteq G$ be the subgroupoid of $T = \{\{0, 8\}, \min, \max\} \subseteq S$ be the subsemiring of S . TB be the subgroupoid subsemiring of SG . TB is of finite order and is not an ideal of SG .

Example 4.22: Let $G = \{\{0, 142\}, *, (140, 2)\}$ be the special interval groupoid of type I. $S = \{\{0, 5\}, \min, \max\}$ be the semiring. SG the groupoid semiring of the groupoid G over the semiring S . SG has subsemirings of infinite order.

$T = \{\{0, 5\}, \min, \max\}$ be the semiring. $G = \{Z_{142}, *, (140, 2)\}$ be the groupoid. TG be the groupoid ring; $TG \subseteq SG$ is a subsemiring. $H = \{Z_{142}, *, (140, 2)\}$ be the subgroupoid G . $W = \{Z_{142}, \min, \max\}$ is a subsemiring of S . WH is a subsemiring which is non commutative and non associative.

Example 4.23: Let $S = \{\{0, 20\}, \min, \max\}$ be a semiring. $G = \{\{0, 224\}, *, (12, 12)\}$ be the groupoid. SG be the groupoid semiring of the groupoid G over the semiring S . SG has non trivial subsemirings. SG is commutative and of infinite order. SG has both finite and infinite order subsemirings which are not ideals.

Example 4.24: Let $S = \{\{0, 25\}, \min, \max\}$ be the special interval semiring. $P = \{\{0, 25\}, *, (5, 5)\}$ be the special interval groupoid of type I. SP be the groupoid semiring of the groupoid of type I.

SP be the groupoid semiring of the groupoid P over the semiring S . $G = \{Z_{25}, *, (5, 5)\} \subseteq P$ be the special interval subgroupoid. SG be the subsemiring of SP . SG is of infinite order.

Let $T = \{Z_{25}, \min, \max\}$ be the special interval subsemiring. TG be the groupoid subsemiring. TG is a finite ordered subsemiring of SP .

Now we give examples of non associative semirings using type II groupoids using $[0, n)$.

Example 4.25: Let $S = \{Z^+ \cup \{0\}\}$ be the semiring. $G = \{[0, 6), *, (2.1, 3.8)\}$ be the special interval groupoid of type II. SG be the groupoid semiring of the groupoid G over the semiring S . SG will also be known as type II groupoid semiring or groupoid semiring of type II.

SG is of infinite order. Let $x = 8 (3.2) + 9 (4)$ and $y = 10 (1.6) + 3 (1.2) \in SG$

$$\begin{aligned} x \times y &= (8 (3.2) + 9 (4)) \times (10 (1.6) + 3 (1.2)) \\ &= 80 [3.2 * 1.6] + 90 (4 * 1.6) + 24 (3.2 * 1.2) + \\ &\quad 27 (4 * 1.2) \end{aligned}$$

$$\begin{aligned} &= 80 [3.2 \times 2.1 + 3.8 \times 1.6] + 90 [4 \times 2.1 + 1.6 \times \\ &\quad 3.8] + 24 [3.2 \times 2.1 + 1.2 \times 3.8] + 27 [4 \times 2.1 + \\ &\quad 3.8 \times 1.2] \end{aligned}$$

$$\begin{aligned} &= 80 [6.72 + 6.08] + 90 [8.4 + 6.08] + 24 [6.72 + \\ &\quad 4.56] + 27 [8.4 + 4.56] \end{aligned}$$

$$= 80 (0.8) + 90 (2.48) + 24 (5.28) + 27 (0.96) \dots I$$

$$y \times x = [10 (1.6) + 3 (1.2)] \times [8 (3.2) + 9 (4)]$$

$$\begin{aligned} &= 80 [1.6 * 3.2] + 24 (1.2 \times 3.2) + 90 (1.6 * 4) + \\ &\quad 27 (1.2 * 4) \end{aligned}$$

$$\begin{aligned} &= 80 [1.6 \times 2.1 + 3.2 \times 3.8] + 24 [1.2 \times 2.1 + 3.2 \times \\ &\quad 3.8] + 90 [1.6 \times 2.1 + 4 \times 3.8] + 27 [1.2 \times 2.1 + \\ &\quad 4 \times 3.8] \end{aligned}$$

$$\begin{aligned} &= 80 [3.36 + 12.16] + 24 [2.56 + 12.16] + \\ &\quad 90 [3.36 + 15.2] + 27 [2.56 + 15.2] \end{aligned}$$

$$= 80 (3.52) + 24 (2.72) + 90 (0.56) + 27 (5.76)$$

... II

I and II are distinct so SG is a non commutative semiring of type II.

Example 4.26: Let $G = \{[0, 8), *, (3.5, 4)\}$ be the special interval groupoid of type II. $R = \{Q^+ \cup \{0\}\}$ be the semiring of reals. RG be the groupoid semiring of type II.

RG is a non associative and non commutative groupoid semiring of type II.

Example 4.27: Let $S = \{Q^+ \cup \{0\}\}$ be the semiring. $G = \{[0, 7), *, (6.6, 2.4)\}$ be the special interval groupoid of type II. SG be the groupoid semiring of type II.

Let $x = 9 (3) + 8 (0.6)$,
 $y = 8 (0.8) + 12 (0.2)$ and $z = 10 (0.4) \in SG$.

$$\begin{aligned}
 (x \times y) \times z &= [(9 (3) + 8 (0.6)) \times (8 (0.8) + 12 (0.2))] \times \\
 &\quad 10 (0.4) \\
 &= [72 (3 * 0.8) + 64 (0.6 * 0.8) + 108 (3 * 0.2) \\
 &\quad + 96 (0.6 * 0.2)] \times (10 (0.4)) \\
 &= [72 (3 \times 6.6 + 0.8 \times 2.4) + 64 (0.6 \times 6.6 + \\
 &\quad 0.8 \times 2.4) + 108 (3 \times 6.6 + 0.2 \times 2.4) + \\
 &\quad 96 (0.6 \times 6.6 + 0.2 \times 2.4)] * 10 (0.4) \\
 &= [72 (19.8 + 1.92) + 64 (3.96 + 1.92) + \\
 &\quad 108 (19.8 + 0.48) + 96 (3.96 + 0.48)] + \\
 &\quad 10 (0.4) \\
 &= 72 (21.72) + 64 (5.88) + 108 (20.28) + \\
 &\quad 96 (4.44)] 10 (0.4) \\
 &= 720 (21.72 * 0.4) + 640 (5.88 * 0.4) + \\
 &\quad 1080 (20.28 * 0.4) + 96 (4.44 * 0.4) \\
 &= 720 (21.72 \times 6.6 + 0.4 \times 2.4) + 640 (5.88 \times \\
 &\quad 6.6 + 0.4 \times 2.4) + 1080 (20.28 \times 6.6 + \\
 &\quad 0.4 \times 2.4) + 96 (4.44 \times 6.6 + 0.4 \times 2.4) \\
 &= 720 (5.712) + 640 (4.768) + 1080 (1.808) + \\
 &\quad 960 (2.264) \quad \dots \quad I
 \end{aligned}$$

$$\begin{aligned}
 x * (y * z) &= [9(3) + 8(0.6)] * \{ [8(0.8) + 12(0.2)] * \\
 &\quad 10(0.4) \} \\
 &= [9(3) + 8(0.6)] [80(0.8 * 0.2) + \\
 &\quad 120(0.2 \times 6.6 + 0.4 \times 2.4)] \\
 &= [9(3) + 8(0.6)] [80 [5.28 + 0.48] + \\
 &\quad 120 (1.32 + 0.96)] \\
 &= [9(3) + 8(0.6)] [80(5.76) + 120(2.28)] \\
 &= 720(3 * 5.76) + 640(0.6 \times 5.76) + \\
 &\quad 1080(3 * 2.28) + 960(0.6 * 2.28) \\
 &= 720(6.6 \times 3 + 2.4 \times 5.76) + 640(0.6 \times 6.6 + \\
 &\quad 5.76 \times 2.4) + 1080(6.6 \times 3 + 2.4 \times 2.28) + \\
 &\quad 960(0.6 \times 6.6 + 2.28 \times 2.4) \\
 &= 720 [19.8 + 13.824] + 640(3.96 + 13.824) + \\
 &\quad 1080(19.8 + 5.472) + 960(3.96 + 5.472) \\
 &= 720(5.624) + 640(3.784) + 1080(4.272) + \\
 &\quad 960(2.432) \quad \dots \quad \text{II}
 \end{aligned}$$

I and II are distinct so the associative law is not true so SG is a non associative semiring.

Example 4.28: Let $S = \{\mathbb{R}^+ \cup \{0\}\}$ be the semiring.

$G = \{[0, 24), *, (12.5, 10.5)\}$ be the special interval groupoid of type II. SG be the groupoid semiring. SG is non associative and non commutative semiring of infinite order.

Example 4.29: Let $S = \{\mathbb{Z}^+ \cup \{0\}\}$ be the semiring. $G = \{[0, 240), *, (101.7, 6.9)\}$ be the special interval groupoid of type II. SG be the special interval groupoid semiring of type II of infinite order.

Example 4.30: Let $S = \{(\mathbb{R}^+ \cup \{0\}) \times (\mathbb{Q}^+ \cup \{0\})\}$ be the semiring. $G = \{[0, 26), *, (13.9, 0)\}$ be the special interval

groupoid of type II. SG be the groupoid semiring of the type II of infinite order.

Example 4.31: Let $S = \{C \times (Z^+ \cup \{0\})\}$ be the semiring of infinite order. $G = \{[0, 27), *, (9.27, 10.63)\}$ be the special interval groupoid semiring of type II of infinite order and is non associative and non commutative.

Example 4.32: Let $S = \{R^+ \cup \{0\} \times C\}$ be the semiring and $G = \{[0, 15), *, (8.5), 6.5)\}$ be the special interval groupoid of type II. SG be the groupoid semiring of type II.

Example 4.33: Let $S =$

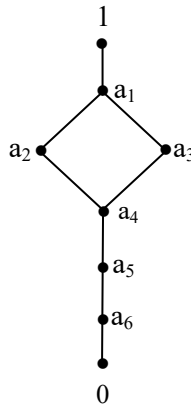

be the semiring. $G = \{[0, 20), *, (5.5, 15.5)\}$ be the groupoid of type II. SG be the groupoid semiring of type II of infinite order and is non commutative.

Example 4.34: Let $S =$

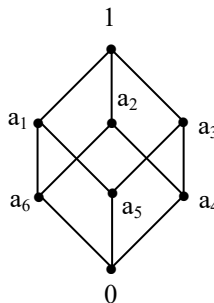

be the semiring. $G = \{[0, 17], *, (16.2, 0.8)\}$ be the groupoid of type II. SG be the groupoid semiring of type II. Let $x = a_1 8 + a_3 4$ and $y = a_6 6 + a_4 9 \in SG$.

$$\begin{aligned}
 x * y &= (a_1 8 + a_3 4) \times (a_6 6 + a_4 9) \\
 &= a_1 a_6 (8 * 6) + a_3 a_6 (4 * 6) + a_1 a_4 (8 * 9) + a_3 a_4 (4 * 9) \\
 &= a_6 (16.2 \times 8 + 0.8 \times 6) + 0 + 0 + a_4 (16.2 \times 4 + 0.8 \times 9) \\
 &= a_6 (129.6 + 4.8) + a_4 (64.8 + 7.2) \\
 &= a_6 (15.4) + a_4 (4) \quad \dots \text{ I}
 \end{aligned}$$

$$\begin{aligned}
 \text{Consider } y \times x &= (a_6 6 + a_4 9) \times (a_1 8 + a_3 4) \\
 &= a_6 a_1 (6 * 8) + a_4 a_1 (9 * 8) + a_6 a_3 (6 * 4) + a_4 a_3 (9 * 4) \\
 &= a_6 (16.2 \times 6 + 0.8 \times 8) + a_4 (16.2 \times 9 + 0.8 \times 4) \\
 &= a_6 (97.2 + 6.4) + a_4 (145.8 + 3.2) \\
 &= a_6 1.6 + a_4 13 \quad \dots \text{ II}
 \end{aligned}$$

I and II distinct hence SG is a non commutative structure.

It is easily verified SG is a non associative structure.

Example 4.35: Let $V =$

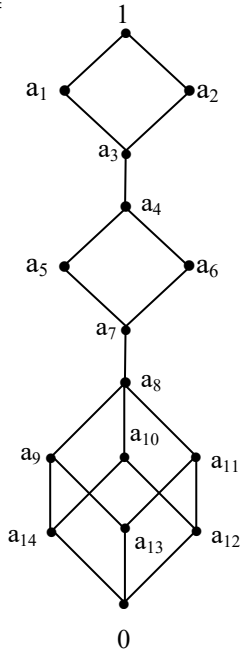

be the semiring of finite order. $G = \{[0, 27), *, (14.3, 12.7)\}$ be the special interval groupoid of type II. SG be the groupoid semiring of type II. SG is of infinite order non associative and non commutative and has several zero divisors.

Example 4.36: Let $S =$

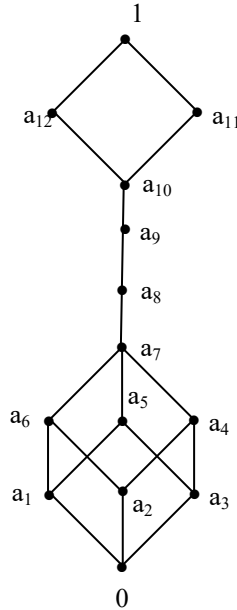

be the semiring. $G = \{[0, 13), (6.5, (6.5), *\}$ be the special interval groupoid of type II. SG be the special interval groupoid semiring of infinite order of type II.

SG has infinite number of zero divisors.

Inview of this we have the following theorem.

THEOREM 4.1: *Let S be a semiring (a lattice with zero divisors). $G = \{[0, n), *, (t, u), t, u \in [0, n) \setminus \mathbb{Z}_n\}$ be the special interval groupoid of type II. SG the groupoid semiring of type II has infinite number of zero divisors if and only if S has zero divisors.*

Proof: Let S be a distributive finite lattice with zero divisors. Clearly SG the groupoid semiring of type II where $G = \{[0, n), *, (t, u); t, u \in [0, n) \setminus \mathbb{Z}_n\}$ is the special interval groupoid of type II has infinite number of zero divisors.

For if $a, b \in S$ with $a.b = 0$ ($a \neq 0, b \neq 0$) then $ag_i \times bg_j = 0$ for all $g_i, g_j \in G$. Since $|G| = \infty$. SG has infinite number of zero divisors.

On the contrary if S has no zero divisors, groupoids of type II in general may or may not have zero divisors, so SG may or may not have zero divisors. Hence if SG has infinite number of zero divisors it is pertinent S must have zero divisors for type II groupoids or type I groupoids.

Hence the claim.

Example 4.37: Let $S =$

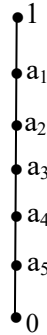

be the semiring of finite order. $G = \{[0, 24), *, (13.5, 17.81)\}$ be the special interval groupoid of type II. SG be the groupoid semiring of type II. SG can have only finite number of zero divisors.

Example 4.38: Let $S =$



be the semiring. $G = \{[0, 9), *, (6.30717, 2.150593)\}$ be the special interval groupoid of type II. SG be the groupoid semiring of type II. SG has infinite no zero divisors.

Inview of this we have the following theorem.

THEOREM 4.2: Let $S = \begin{matrix} 1 \\ \bullet \\ \downarrow \\ \bullet \\ 0 \end{matrix}$

be the semiring (Boolean algebra of order two) and $G = \{[0, n), *, (t, s) \text{ where } t, s \in [0, n) \setminus Z_n \text{ are of the form } t = p.p_1 p_2 \dots p_t \text{ and } s = q.q_1 q_2 \dots q_s \text{ and } n, t \text{ and } s \text{ are prime numbers}\}$ be the special interval groupoid of type II. SG be the groupoid semiring of type II. SG has no zero divisors of the form $x.y = 0; x, y \in G$.

Proof follows from the simple fact G has no zero divisors.

It is left as an open problem; if $\alpha = \sum g_i$ and $\beta = \sum h_j, g_i, h_j \in G$ can $\alpha.\beta = 0$?

Example 4.39: Let $S =$

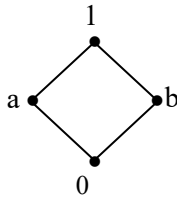

be the semiring. $G = \{[0, 23), *, (0.737161, 0.6120017)\}$ be the special interval groupoid of type II. SG be the groupoid semiring of type II. SG has infinite number of zero divisors.

The answer to the problem is easy as in case of lattices which are semirings. The sum can never be zero unless each term is zero as the semiring is $S =$



This is true in case of any distributive lattice as the sum to be zero is impossible.

Example 4.40: Let $S =$



be the semiring. $G = \{ [0, 15), *, (10.21017, 2.00613) \}$ be the special interval groupoid of type II. SG be the groupoid semiring of type II. SG is of infinite order and is non commutative and non associative.

Example 4.41: Let $S =$

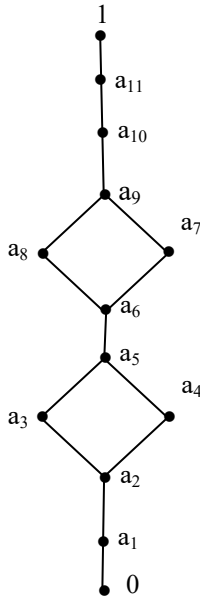

be the distributive lattice of finite order. S is a commutative semiring. $G = \{ [0, 16), *, (3.007, 7.60123) \}$ be the special

interval groupoid of type II. SG be the groupoid semiring of type II.

Now we have to define finite commutative semirings of type II.

Example 4.42: Let $S = \{LS_5$ where $L =$

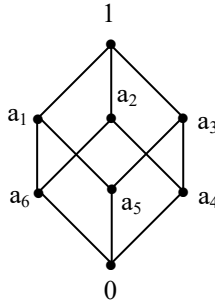

and S_5 be the symmetric group} be the non commutative group semiring of finite order.

$G = \{[0, 7), *, (3.0063, 4.20057)\}$ be the special interval groupoid of type II. SG be the groupoid semiring of type II. SG be the groupoid semiring of type II. SG is doubly non commutative and non associative.

Example 4.43: Let

$S = \{(Z^+ \cup \{0\}) (g_1, g_2, g_3); g_i g_j = g_j g_i = 0, g_i^2 = 0, 1 \leq i, j \leq 3\}$ be the semiring of infinite order. $G = \{[0, 81), *, (17.09631, 0.7108157)\}$ be the special interval groupoid of infinite order of type II. SG be the groupoid semiring of type II.

Clearly SG has infinite number of zero divisors.

Example 4.44: Let

$S = \{(Q^+ \cup \{0\}) (g_1, g_2) | g_1^2 = 0, g_2^2 = g_2, g_1 g_2 = g_2 g_1 = 0\}$ be the semiring. $G = \{[0, 12), *, (0.5731, 0.63121)\}$ be the groupoid of type II. SG be the groupoid semiring of type II. SG has idempotents and infinite number of zero divisors.

Example 4.45: Let $S = \{(R^+ \cup \{0\}) (g_1, g_2, g_3, g_4) \mid g_1^2 = 0 = g_3^2; g_2^2 = g_2, g_4^2 = g_4; g_i g_j = g_j g_i = 0, 1 \leq i, j \leq 4\}$ be the semiring of infinite order.

$G = \{[0, 26), *, (3.0017337, 0.56021073)\}$ be the groupoid of type II of infinite order. SG be the groupoid semiring of infinite order of type II. SG has zero divisors.

Let $x = g_1 3.721 \in SG; x^2 = 0$ is a zero divisor and nilpotent of order two. $x_1 = g_3 9.300089 \in SG$.

$$\begin{aligned} x_1^2 &= (g_3 9.300089) * (g_3 9.300089) \\ &= g_3 \cdot g_3 (9.300089 * 9.300089) \\ &= 0 \text{ (non zero element in } G) \\ &= 0 \text{ is a zero divisors and nilpotent of order two.} \end{aligned}$$

Example 4.46: Let $S = \{(Q^+ \cup \{0\}) (g_1, g_2, g_3) \mid g_i^2 = 0; g_i g_j = 0 = g_j g_i, 1 \leq i, j \leq 3\}$ be the semiring of infinite order.

$G = \{[0, 92), *, (0.33011, 3.6002173)\}$ be the special interval groupoid of type II. SG be the groupoid semiring of type II.

We can have several such properties, we just indicate the groupoid neutrosophic semiring using groupoids and neutrosophic semirings.

Example 4.47: Let $S = \{(Z^+ \cup I \cup \{0\})\}$ be the neutrosophic semiring of infinite order. $G = \{[0, 20), *, (10.333, 7.777)\}$ be the special interval groupoid of type II. SG be the groupoid semiring of type II. SG is also known as the neutrosophic groupoid semiring of type II of infinite order. SG is both non commutative and non associative.

Example 4.48: Let $S = \{(Q^+ \cup I \cup \{0\})\}$ be the neutrosophic $G = \{[0, 12), *, (1.7777, 3.711111)\}$ be the special interval groupoid of type II. SG be the special interval neutrosophic

groupoid semiring of infinite order which is non commutative and non associative of type II.

Example 4.49: Let $S = \{\langle R^+ \cup I \cup \{0\} \rangle\}$ be the neutrosophic semiring. $G = \{[0, 10), *, (3.3331, 7.77773)\}$ be the special interval groupoid of type II. SG be the groupoid semiring of type II. SG is a neutrosophic non associative and non commutative semiring.

Example 4.50: Let $S = \{\langle Z^+ \cup I \cup \{0\} \rangle\}$ be the neutrosophic semiring. $G = \{[0, 520), *, (0, 0.331137)\}$ be the special interval groupoid of type II. SG be the special interval neutrosophic groupoid semiring of type II.

Next we proceed onto study the notion of non associative rings using the special interval groupoids of type I and type II. This will be illustrated by examples.

Example 4.51: Let $R = Z_{10}$ be the ring of modulo integers. $G = \{[0, 6), *, (3, 2)\}$ be the special interval groupoid of type I. RG be the special interval groupoid ring of type I. RG is of infinite order. RG is both non associative and non commutative.

$$\begin{aligned} \text{Let } x &= 6(3) + 9(4) \text{ and} \\ y &= 7(2) + 3(5) \in RG. \end{aligned}$$

$$\begin{aligned} x \times y &= [6(3) + 9(4)] \times [7(2) + 3(5)] \\ &= 2(3 * 2) + 3(4 * 2) + 8(3 * 5) + 7(4 * 5) \\ &= 2[9 + 4] + 3(12 + 4) + 8[9 + 10] + 7[12 + 10] \\ &= 2(1) + 3(4) + 8(1) + 7(4) \\ &= 8(1) + 7(4) \qquad \dots \text{ I} \end{aligned}$$

$$\begin{aligned} y \times x &= 7(2) + 3(5) \times 6(3) + 9(4) \\ &= 2(2 * 3) + 8(5 * 3) + 3(2 * 4) + 7(5 * 4) \\ &= 2(6 + 6) + 8[15 + 6] + 3[6 + 8] + 7[15 + 8] \\ &= 2(0) + 8(3) + 3(2) + 7(5) \qquad \dots \text{ II} \end{aligned}$$

I and II are distinct so RG is a non commutative semiring.

Let $x = 2 (5) + 5 (3)$

$y = 7 (3)$ and $z = 4 (3) \in \text{RG}$.

$$\begin{aligned} \text{Now } (x * y) * z &= [(2 (5) + 5 (3)) * 7 (3)] * z \\ &= [4 (5 * 3) + 5 (3 * 3)] * z \\ &= [4 (3) + 5 (3)6] + 4 (3) \\ &= 6 (3) + 0 (3) \\ &= 6 (3) \quad \dots \text{ I} \end{aligned}$$

$$\begin{aligned} x * (y * z) &= [2 (5) + 5 (3)] * [7 (3) * 4 (3)] \\ &= [2 (5) + 5 (3)] * (8 (3)) \\ &= 6 (5 * 3) + 0 \\ &= 6 (3) \quad \dots \text{ II} \end{aligned}$$

We see for this triple the operation product is associative.

However we have triples in RG which are non associative.

Let $x = a (2)$ and $y = b (3) \in \text{RG}$.

$$\begin{aligned} x \times y &= a (2) \times b (3) \\ &= ab [a * 3] \\ &= ab [6 + 6] \\ &= 0. \end{aligned}$$

$$\begin{aligned} \text{However } y \times x &= b (3) \times a (2) \\ &= ba [3 * 2] \\ &= ba [9 + 6] \\ &= ba (3) \neq 0. \end{aligned}$$

Thus $x \times y = 0$ and $y \times x \neq 0$ is only a one side zero divisor.

Now let $x = 2 (3)$ and $y = 5 (4) \in \text{SG}$.

$$\begin{aligned} x \times y &= 2 (3) \times 5 (4) \\ &= 2 \times 5 [3 * 4] \\ &= 0 [9 + 8] \\ &= 0 \text{ is a zero divisor.} \end{aligned}$$

It is easily verified $y \times x = 0$.

$$y \times x = 5 (4) \times 2 (3) = 10 [4 * 3] = 0.$$

Example 4.52: Let $R = \{Z_9\}$ be the ring of finite order. $G = \{[0, 11), *, (4, 3)\}$ be the special interval groupoid of type I. RG be the groupoid ring of type I. RG is non commutative, non associative ring and of infinite order. However RG has no zero divisors.

Example 4.53: Let $R = \{Z_{19}\}$ be the ring of integers which is a finite field. $G = \{[0, 19), *, (10, 0)\}$ be the special interval groupoid of type I. RG be the special interval groupoid ring of type I.

RG is an infinite non commutative and non associative ring of infinite order with zero divisors.

Example 4.54: Let $R = Z_{20}$ be the ring of modulo integers. $G = \{[0, 20), *, (10, 10)\}$ be the special interval groupoid ring of type I. RG is commutative and of infinite order.

Example 4.55: Let $R = Z_{20}$ be the ring of integer modulo 20. $G = \{[0, 20), *, (10, 11)\}$ be the special interval groupoid of type I.

RG be the groupoid ring of type I. RG is non commutative and non associative infinite ring.

Example 4.56: Let $R = \{C(Z_{10})\}$ be the ring of complex modulo integers. $G = \{[0, 10), *, (5, 5)\}$ be the groupoid of type I. RG the groupoid ring of type I.

$$\begin{aligned}
 x &= 4i_F(3) + 3(5) \text{ and} \\
 y &= 3i_F(8) + 5(2) \in RG. \\
 x \times y &= (4i_F(3) + 3(5)) \times (3i_F(8) + 5(2)) \\
 &= 4i_F \times 3i_F (3 * 8) + 3 \times 3i_F (5 * 8) + 4i_F \times 5 (3 * 2) + \\
 &\quad 3 \times 5 (5 * 2) \\
 &= 12 \times 9 (15 + 40) + 9i_F (25 + 40) + 20i_F (15 + 10) + \\
 &\quad 15 (25 + 10) \\
 &= 8(5) + 9i_F (5) + 5 (5) \\
 &= 3(5) + 9i_F (5) \in RG.
 \end{aligned}$$

This is the way operations on RG is performed.

Let $x = 3(2) + 4i_F + 2(5)$

$y = (7 + i_F)(4)$ and $z = 5(3) \in RG$.

$$\begin{aligned} (x \times y) \times z &= \{[3(2) + (4i_F + 2)(5)] \times 7 + i_F(4)\} * 5(3) \\ &= [(7 + i_F)3[2 * 4] + (4i_F + 2)(7 + i_F)(5 * 4)] * 5(3) \\ &= \{(1 + 3i_F)(10 + 20) + (28i_F + 14 + 4 \times 9 + 2i_F)(5)\} 5(3) \\ &= 0 \qquad \qquad \qquad \dots \text{ I} \end{aligned}$$

$$\begin{aligned} x \times (y \times z) &= 3(2) + (4i_F + 2)(5) \times [(7 + i_F)(4) \times 5(3)] \\ &= [3(2) + (4i_F + 2)(5)] \times [(35 + 5i_F)(5)] \\ &= (3 \times 35 + 5i_F)(2 * 5) + (4i_F + 2)(35 + 5i_F)[5 * 5] \\ &= (5 + 5i_F)(5) + 0 \qquad \qquad \dots \text{ II} \end{aligned}$$

I and II are different hence RG is a non commutative complex modulo integer non associative ring of infinite order.

Example 4.57: Let $R = C(Z_{10})$ be the finite complex modulo integer and $G = \{[0, 16), *, (8, 4)\}$ be the special interval groupoid of type I. RG be the special interval groupoid ring of infinite order.

Let $x = (3 + 5i_F)(4) + (8 + 7i_F)(8) \in RG$.

Now

$$\begin{aligned} x \times x &= \{(3 + 5i_F)(4) + (8 + 7i_F)8\} \times \\ &\qquad \qquad \qquad \{(3 + 5i_F)(4) + (8 + 7i_F)8\} \\ &= (3 + i_F)^2(4 * 4) + (8 + 7i_F)(3 + 5i_F)(8 * 4) + \\ &\qquad \qquad \qquad (3 + 5i_F)(8 + 7i_F)(4 * 8) + (8 + 7i_F)(8 + 7i_F) \\ &\qquad \qquad \qquad (8 * 8) \\ &= 0 \qquad \qquad \qquad (\text{since } 4 * 8 = 8 \times 4 + 8 \times 4 = 0 \\ 4 * 4 &= 4 \times 8 + 4 \times 4 = 0 \text{ and} \\ 8 * 8 &= 8 \times 8 + 8 \times 4 = 0); \end{aligned}$$

in multiplication modulo 16. Thus RG has nilpotents of order two.

Example 4.58: Let $R = \{C(Z_{11})\}$ be the complex modulo integer ring. $G = \{[0, 14), *, (7, 8)\}$ be the special interval groupoid of type I. RG is non associative, non commutative and of infinite order.

Example 4.59: Let $R = \{C(Z_7)\}$ be the complex modulo integer ring. $G = \{[0, 16), *, (4, 0)\}$ be the special interval groupoid of type I. RG be groupoid of type I. RG be groupoid ring of infinite order of type I.

Example 4.60: Let $R = \{\langle Z_{11} \cup I \rangle\}$ be the neutrosophic ring. $G = \{[0, 14), *, (10, 5)\}$ be the special interval groupoid of type I. RG be the groupoid ring of type I.

Let $x = 7I + 3(4) + 2I + 4(3)$ and
 $y = 8I(5) + (3 + 2I)(7) \in RG$.

$$\begin{aligned} x \times y &= (7I + 3(4) + 2I + 4(3)) \times (8I(5) + (3 + 2I)(7)) \\ &= (7I + 3)(3 + 2I)(4 * 7) + (7I + 3)(8I)(4 \times 5) + (2I + 4) \\ &\quad \times 8I(3 * 5) + (2I + 4)(3 + 2I)(3 * 7) \\ &= (14I + 6I + 9 + 21I)(40 + 35) + (56I + 24I)(40 + 25) + \\ &\quad (16I + 32I)(30 + 25) + (6I + 12 + 4I + 8I)(30 + 35) \\ &= (8I + 9)(5) + 3I(9) + 4I(13) + (7I + 1)(9) \\ &= (8I + 9)(5) + 4I(13) + (10I+1)(9). \end{aligned}$$

This is the way product is defined on RG . RG is also known as the neutrosophic ring.

Example 4.61: Let $R = \{\langle Z_{12} \cup I \rangle\}$ be the neutrosophic ring of modulo integers. $G = \{[0, 10), *, (6, 4)\}$ be the special interval groupoid of type I. RG the groupoid ring of type I. RG is non commutative, non associative and of infinite order.

Example 4.62: Let R be the reals. $G = \{[0, 8), *, (6, 2)\}$ be the special interval groupoid of type I. RG be the groupoid ring of type I. RG is non commutative, non associative and of infinite cardinality.

THEOREM 4.3: Let R be any ring which is commutative with unit. $G = \{[0, n), *, (t, s) \text{ where } s, t \in \mathbb{Z}_n \setminus \{0\}\}$ be the special interval groupoid of type I. RG be the groupoid ring of type I. RG is a commutative and a non associative ring if and only if $s = t$.

Proof is direct and hence left as an exercise to the reader.

THEOREM 4.4: Let R be any commutative ring. G be a special interval groupoid of type I with non trivial zero divisors. RG be the groupoid ring of type I. RG has zero divisors.

This proof is direct and hence left as an exercise to the reader.

Example 4.63: Let $R = \{C(\langle \mathbb{Z}_5 \cup I \rangle)\}$ be the ring of finite complex neutrosophic modulo integers.

$G = \{[0, 18), *, (9, 9)\}$ be the commutative special interval groupoid of type I. RG be the groupoid ring of type I. RG is commutative and non associative.

$$\begin{aligned} x &= (3I_F + 4I + 2i_F + 1) (6) \in RG \\ x \times x &= (3I_F + 4I + 2i_F + 1)^2 (6 * 6) \\ &= 9I \times 4 + 16I + 4 \times 4 + 1 + (6I_F + 8I + 4i_F + 24I_F + \\ &\quad 12 \times 4I + 16I i_F) (0) \\ &= 0 \text{ is a nilpotent element of order two.} \end{aligned}$$

Example 4.64: Let $R = \{C(\mathbb{Z}_{10}) \times C(\mathbb{Z}_{15})\}$ be the ring of finite order. $G = \{[0, 12), *, (6, 6)\}$ be the special interval groupoid of type I. RG be the groupoid ring of type I. RG has infinite number of zero divisors.

Example 4.65: Let $R = \{C(\mathbb{Z}_{16} \cup I)\}$ be the ring. $G = \{[0, 17), *, (9, 0)\}$ be the special interval groupoid of type I. RG be the groupoid ring of type I.

$$\begin{aligned} \text{Let } x &= 7I + 3(10) + 5I + 7(3) \text{ and} \\ y &= 8I + 6(7) \in RG. \end{aligned}$$

$$\begin{aligned}
 x \times y &= [7I + 3 (10) + 5I + 7 (3)] \times [8I + 6 (7)] \\
 &= (7I + 3) 8I (10 * 7) + (7I + 3) 6 (10 * 7) + (5I + 7) 8I \\
 &\quad (3 * 7) + (5I+7) 6(3*7) \\
 &= (56I + 24I) (90 + 0) + (42 I + 18) (90 + 0) + (40I + 56I) \\
 &\quad (27 + 0) + (30I + 42) (27 + 0) \\
 &= 0 + (10I + 2) (5) + 0 + (14I + 10) (10) \in \text{RG}.
 \end{aligned}$$

This is the way operations are performed on RG.

Example 4.66: Let $R = C (Z_{10})$ be the complex modulo integer ring and $G = \{[0, 10], *, (6, 0)\}$ be the special interval groupoid of type I. RG be the groupoid ring of type I.

$$\begin{aligned}
 \text{Let } x &= 3i_F + 7 (3) + 8i_F + 4 (8), y = 5 + 6i_F (7) \text{ and} \\
 z &= 9 + i_F (5) \in \text{RG}.
 \end{aligned}$$

$$\begin{aligned}
 (x * y) * z &= [(3i_F + 7 (3) + 8i_F + 4 (8)) * 5 + 6i_F (7)] * \\
 &\quad 9 + i_F (5) \\
 &= [(3i_F + 7) (5 + 6i_F) (3 * 7) + (8i_F + 4) (5 + 6i_F) \\
 &\quad (8 * 7)] * (9 + i_F) (5) \\
 &= 15i_F + 35 + 42i_F + 18 \times 9 [18] + (40i_F + 20 + \\
 &\quad 48 \times 9 + 24i_F) [48] * (9 + i_F) (5) \\
 &= [(7i_F + 7) (9+i_F) (8 * 5) + (4i_F + 2) (9+i_F) \\
 &\quad (8 \times 5)] \\
 &= (3i_F + 3 + 3 + 7i_F)(8) + (3i_F + 8 + 2i_F + 4 \times 9) 8 \\
 &= (5i_F + 8) (8) \quad \dots I
 \end{aligned}$$

$$\begin{aligned}
 x * (y * z) &= x * [5 + 6i_F (7) * 9 + i_F (5)] \\
 &= x * [45 + 54i_F + 5i_F + 54 (7 * 5)] \\
 &= [3i_F + 7(3) + 8i_F + 4 (8)] * (9 + 9i_F) (2) \\
 &= (3i_F + 7) (9 + 9i_F) (3 * 2) + (8i_F + 4) (9 + 9i_F) \\
 &\quad (8 * 2) \\
 &= 27i_F + 63i_F + 27 \times 9 + 63 [8] + (72i_F + 36i_F + \\
 &\quad 36 + 72 \times 9) [8] \\
 &= 6 (8) + (8i_F + 4) (8)
 \end{aligned}$$

$$= 8i_F (8) \quad \dots \quad II$$

I and II are distinct so RG is a non associative groupoid ring of type II.

Example 4.67: Let $R = \langle Z_{12} \cup I \rangle$ be the ring of neutrosophic modulo integers. $G = \{[0, 20), *, (12, 8)\}$ be the special interval groupoid of type I. RG be the groupoid ring of type I.

Example 4.68: Let C be the ring of complex numbers. $G = \{[0, 20), *, (12, 8)\}$ be the special interval groupoid of type I. CG be the groupoid ring of complex number of type I.

$$\text{Let } x = (3 + 5i) 8 + (10 + i) (7) \text{ and } y = (7 + 11i) (5) \in CG$$

$$\begin{aligned} x \times y &= [(3 + 5i) 8 + (10 + i) (7)] \times (7 + 11i) (5) \\ &= (3 + 5i) (7 + 11i) 8 * 5 + (10 + i) (7 + 11i) (7 * 5) \\ &= (21 + 35i + 33i - 55) (96 + 40) + (70 + 7i + 110i - 11) (84 + 40) \\ &= (-34 + 68i) (16) + (59 + 117i) (4). \end{aligned}$$

This is the way the product on CG is performed. CG will be known as the complex special interval non associative groupoid ring of type I.

Example 4.69: Let $R = \{C \cup I\}$ be the complex neutrosophic ring. $G = \{[0, 24), *, (12, 12)\}$ be the special interval groupoid of type I. RG be the groupoid ring of type I. RG is known as the complex neutrosophic non associative ring which is commutative and is of infinite order.

Example 4.70: Let $R = \{C(Z_5) \times Z_7\}$ be the ring and $G = \{[0, 47), *, (27, 20)\}$ be the special interval groupoid of type I. RG be the groupoid ring of type I. RG is non associative and non commutative.

Example 4.71: Let $R = \{Z \cup I\}$ be the complex neutrosophic ring. $G = \{[0, 29), *, (10, 19)\}$ be the special interval groupoid

of type I. RG be the groupoid ring. RG has infinite number of zero divisors.

Let $x = (7 - 7I) (3.77) + (8 - 8I) (4) + (-6 + 6I) (27.5) + (120 - 120I) (7) \in RG$ and $y = I$, now $x \times y = y \times x = 0$. So RG has this type of zero divisors which are infinite in number.

Example 4.72: Let $R = \{Z_9 \times C(Z_{15}) \times \langle Z_{12} \cup I \rangle\}$ be the ring. $G = \{[0, 25), *, (13, 12)\}$ be the special interval groupoid of type I. RG be the groupoid ring. RG has infinite number of zero divisors.

Example 4.73: Let $R = \{Q (g_1, g_2) = \{ag_1 + bg_2 + c; a, b, c \in Q, g_1^2 = 0, g_2^2 = g_2, g_1g_2 = g_2g_1 = 0\}\}$ be the ring.

$G = \{[0, 21), *, (10, 11)\}$ be the special interval groupoid of type I. RG be the groupoid ring of type I. RG has infinite number of zero divisors.

Next we proceed onto define the new notion of groupoid rings of type II using special interval groupoids of type II.

Let R be any ring. G be the special interval groupoid of type II.

$RG = \{\text{Collection of all finite formal sums of the form } \sum_{i=0}^n a_i g_i; a_i \in R, g_i \in G\}$. RG is a ring which is non associative defined as the groupoid ring of type II.

We will illustrate this situation by some examples.

Example 4.74: Let $R = Z$ the ring of integers and $G = \{[0, 9), *, (3.1, 6.2)\}$ be the special interval groupoid ring of the groupoid G over the ring R of type II. RG is non associative, non commutative and of infinite order.

Let $x = 3(4) + 7 (5.31) + 8 (2.5)$ and $y = 8 (3.1) + 5 (7.2) \in RG$.

$$\begin{aligned}
 x \times y &= [3(4) + 7(5.31) + 8(2.5)] \times [8(3.1) + 5(7.2)] \\
 &= 24(4 * 3.1) + 56(5.31 * 3.1) + 64(2.5 * 3.1) + \\
 &\quad 15(4 * 7.2) + 35(5.31 * 7.2) + 40(2.5 * 7.2) \\
 &= 24(12.4 + 19.22) + 56(16.461 + 19.22) + \\
 &\quad 64(7.75 + 19.22) + 15(12.4 + 44.64) + \\
 &\quad 35(16.461 + 44.64) + 40(7.75 + 44.64) \\
 &= 24(4.62) + 56(8.681) + 64(8.72) + 15(3.04) + \\
 &\quad 35(5.001) + 40(7.39)
 \end{aligned}$$

... I

Consider

$$\begin{aligned}
 y \times x &= [8(3.1) + 5(7.2)] \times [3(4) + 7(5.31) + \\
 &\quad 8(2.5)] \\
 &= 24(3.1 * 4) + 56(3.1 * 5.31) + 64(3.1 * 2.5) \\
 &\quad + 15(7.2 * 4) + 35(7.2 * 5.31) + \\
 &\quad 40(7.2 * 2.5) \\
 &= 24[9.61 + 24.8] + 35(22.32 + 24.8) + \\
 &\quad 56(9.61 + 32.922) + 64(9.61 + 15.50) \\
 &\quad + 15(22.32 + 24.8) + 40(22.32 + \\
 &\quad 15.50) \\
 &= 24(7.41) + 35(2.12) + 56(6.532) + 64(7.11) \\
 &\quad + 15(2.82) + 40(1.82) \quad \dots \text{ II}
 \end{aligned}$$

$x = 10(3)$, $y = 5(1.6)$ and $z = 8(5) \in \text{SG}$.

$$\begin{aligned}
 (x * y) * z &= [10(3) * 5(1.6)] * 8(5) \\
 &= [50(3 * 1.6)] * [8(5)] \\
 &= [50(3.1 \times 3 + 1.6 \times 6.2)] * 8(5) \\
 &= 50(9.3) + 9.92 * 8(5) \\
 &= 50(1.22) * 8(5) \\
 &= 400(1.22 * 5) \\
 &= 400(1.22 \times 3.1 + 6.2 \times 5) \\
 &= 400(3.782 + 31)
 \end{aligned}$$

$$\begin{aligned}
 &= 400 (34.782) \\
 &= 400 (7.782) \qquad \dots \text{ I}
 \end{aligned}$$

$$\begin{aligned}
 &\text{Consider } x * (y * z) \\
 &= x [5 (1.6) * 8 (5)] \\
 &= x * [40 (1.6 * 5)] \\
 &= x * [40 (1.6 \times 3.1 + 5 \times 6.2)] \\
 &= x * [40 (4.96 + 31.0)] \\
 &= 10 (3) * 40 (8.96) \\
 &= 400 (3.1 \times 3 + 8.96 \times 62) \\
 &= 400 (9.3 + 55.552) \\
 &= 400 (0.3 + 1.552) \\
 &= 400 (1.852) \qquad \dots \text{ II}
 \end{aligned}$$

I and II are distinct so RG is a non commutative and non associative group ring of type II.

Example 4.75: Let $R = \mathbb{C}$ be the ring of complex numbers. $G = \{[0, 11), *, (5.5, 5.5)\}$ be the special interval groupoid of type II. RG be the groupoid ring of type II. RG is of infinite order and is non associative but commutative.

Example 4.76: Let $R = \{Z(g_1, g_2, g_3) \mid g_1^2 = 0, g_2^2 = g_2, g_3^2 = -g_3, g_i g_j = g_j g_i = 0, 1 \neq j, 1 \leq i, j \leq 3\}$ be the ring. $G = \{[0, 16), *, (3.8, 13.2)\}$ be a special interval groupoid. RG be the groupoid ring of type II. RG is non commutative, non associative and has zero divisors.

Example 4.77: Let $R = \{R(g_1, g_2) \mid g_1^2 = 0, g_2^2 = 0, g_1 g_2 = g_2 g_1 = 0\}$ be the ring. $G = \{[0, 24), *, (12.4, 11.6)\}$ be a special interval groupoid of type II. RG be the groupoid ring of type II. RG is non commutative, non associative and is of infinite order. RG has infinite number of zero divisors.

Example 4.78: Let $R = \{C(Z_{12})\}$ be the complex modulo finite integers. $G = \{[0, 7), *, (3.2, 38)\}$ be a special interval groupoid of type II. RG be the groupoid ring of type II.

Example 4.79: Let $R = \{\langle Z_{15} \cup I \rangle\}$ be the neutrosophic ring. $G = \{[0, 12), *, (4.3, 8.7)\}$ be a special interval groupoid of type II. RG be the groupoid ring of the groupoid G over the ring R of type II. RG has infinite number of zero divisors.

$(5 + 10I) I = 0$ $(8 + 7I) I = 0$ in R so $x = (5 + 10I) (8.3)$ and $y = I (7.2) \in RG$ is such that $xy = 0$.

Example 4.80: Let $R = \{C(Z_{18})\}$ be the finite complex modulo integer ring. $G = \{[0, 18), *, (12.3, 6.7)\}$ be the special interval groupoid of type II. RG be the groupoid ring of type II. Let $x = (3i_F + 2) (10)$, $y = 5i_F + 9 (3)$ and $z = (8i_F + 1) (1.2) \in RG$.

$$\begin{aligned}
 x * (y * z) &= (3i_F + 2) (10) * (5i_F + 9 (3) * (8i_F + 1) (1.2)) \\
 &= (3i_F + 2) (10) * (5i_F + 9 (3) * (8i_F + 1) (1.2)) \\
 &= (3i_F + 2) (10 [(5i_F + 9) \times (8i_F + 1) [3 * 1.2]]) \\
 &= (3i_F + 2) (10) [40 \times 17 + 5i_F + 72i_F + 9] (36.8 + 8.04) \\
 &= (3i_F + 2) (10) [(5i_F + 5) (8.94)] \\
 &= (3i_F + 2) (5 + 5i_F) (10 * 8.94) \\
 &= (15i_F + 10 + 10 i_F + 15 \times 17) [123 + 6.7 \times 8.94] \\
 &= (7i_F + 1) [5.83 + 3.31] \\
 &= (7i_F + 1) (9.14) \qquad \dots \text{ I}
 \end{aligned}$$

$$\begin{aligned}
 (x * y) * z &= [(3i_F + 2) (10) * (5i_F + 9 (3))] * z \\
 &= [(15 + 11 + 10i_F + 27i_F + 18) (10 * 3)] * z \\
 &= (i_F + 3) [124 + 20.1] * z \\
 &= (3 + i_F) 17.1 * (8i_F + 1) (1.2) \\
 &= (3 + i_F) (8i_F + 1) [17.1 * 1.2] \\
 &= (24i_F + i_F + 8 \times 17 + 3) (17.1 * 1.2) \\
 &= (7i_F + 13) [17.1 \times 12.3 + 6.7 \times 1.2] \\
 &= (7i_F + 13) (2.33 + 8.04) \\
 &= (7i_F + 13) (10.37) \qquad \dots \text{ II}
 \end{aligned}$$

I and II are distinct so RG is non commutative and non associative.

Example 4.81: Let $R = \{Z_{10} \times Z_{11} \times Z_{12}\}$ be the ring. $G = \{[0, 10), *, (2.5, 7.5)\}$ be the special interval groupoid of type II. RG be the special interval groupoid ring of type II.

RG is of infinite order, non commutative and non associative and has infinite number of zero divisors.

Example 4.82: Let $R = \{\langle R \cup I \rangle\}$ be the neutrosophic ring of reals. $G = \{[0, 13), *, (6.5, 6.5)\}$ be the special interval groupoid of type II. RG be the groupoid ring of type II. RG has infinite number of zero divisors.

Inview of all these we give the following theorem.

THEOREM 4.5: *Let*

$R = \{\langle Q \cup I \rangle, \text{ or } \langle R \cup I \rangle \text{ or } \langle C \cup I \rangle \text{ or } \langle Z_n \cup I \rangle\}$ *be a neutrosophic ring.*

$G = \{[0, m), *, (t, u), t, u \in [0, m) \setminus Z_m\}$ *be the special interval groupoid of type II. RG be the groupoid ring of type II. RG has infinite number of zero divisors.*

Proof is left as an exercise to the reader.

Example 4.83: Let $R = \{\langle Z_{42} \cup I \rangle\}$ be the neutrosophic ring. $G = \{[0,12), *, (3.3, 8.7)\}$ be the special interval groupoid of type II. RG be the groupoid ring of type II. RG has infinite number of zero divisors.

Example 4.84: Let $R = \{\langle Z_{12} \cup I \rangle\}$ be the finite complex modulo integer ring. $G = \{[0, 5), *, (3.2, 1.8)\}$ be the special interval groupoid of type II. RG be the groupoid ring of type II. RG has infinite number of zero divisors of the form $x = (8 + 4I) (3.2)$ and $y = I (4.3) \in RG$ is such that

$$\begin{aligned} x \times y &= (8 + 4I) (3.2) * I (4.3) \\ &= (8 + 4I) I [3.2 * 4.3] \\ &= (8I + 4I) (3.2 * 4.3) \\ &= 0 \text{ is a zero divisor in RG.} \end{aligned}$$

Example 4.85: Let $R = \{\langle Z_{27} \cup I \rangle\}$ be the neutrosophic ring of finite order. $G = \{[0, 7), *, (3.5, 3.5)\}$ be the special interval groupoid of type II. RG be the groupoid ring of type II. RG has infinite number of zero divisors.

Example 4.86: Let $G = \{[0, 21), *, (3.1, 1.5)\}$ be the special interval groupoid of type II. $R = \{\langle Z \cup I \rangle S_3\}$ be the ring. RG is the groupoid ring of type II. RG has infinite number of zero divisors.

Example 4.87: Let R be a S-ring. G any special interval groupoid of type II. RG be the special interval groupoid ring of type II. RG is a S-ring.

Example 4.88: Let $R = \{\langle Q \cup I \rangle\}$ be the ring. Clearly R is a S-ring. $G = \{[0, 8), *, (3.3, 4.7)\}$ be the special interval groupoid of type II. RG be the groupoid ring of type II. RG is a S-ring.

Inview of all these we have the following theorem.

THEOREM 4.6: *Let R be ring.*

*$G = \{[0, n), *, (t, s); t, s \in [0, n) \setminus Z_n\}$ be the special interval groupoid of type II. RG be the groupoid ring. RG is a S-ring if and only if R is a S-ring.*

Proof is direct hence left as an exercise to the reader.

Now we proceed onto give examples of subrings which are not ideals and ideals in the special interval non associative ring.

Example 4.89: Let $R = \{Z_{20}\}$ be the ring and $G = \{[0, 12), *, (2, 4)\}$ be the special interval groupoid of type I. RG be the groupoid ring of type I. SG where $S = \{0, 2, 4, 6, 8, \dots, 18\} \subseteq R = Z_{20}$ be a subring. SG is a subring which is also an ideal of RG . TG where $T = \{0, 10\} \subseteq Z_{20}$ is the subring of R . TG is the ideal of RG .

Let RP be the subring where $P = \{Z_{12}, *, (2, 4)\} \subseteq G$ be the subgroupoid of G . RP is not an ideal only a subring of type I.

Example 4.90: Let $G = \{[0, 24), *, (12, 12)\}$ be the special interval groupoid of type I of infinite order which is commutative. $R = \{Z_{16}\}$ be the ring of integers. RG be the groupoid ring of type I. $P = \{Z_{24}, *, (12, 12)\} \subseteq G$ be the

subgroupoid of G . RP be the subring of type I. Clearly SG is an ideal of RG . SG has zero divisors.

Example 4.91: Let $R = \mathbb{Z}$ be the ring of integers.

$G = \{[0, 12), *, (8, 4)\}$ be the special interval groupoid of type I. RG be the groupoid ring of type I. RG has subrings which are not ideals and RG has subrings which are ideals. Thus RG has zero divisors and subrings of infinite order.

Example 4.92: Let R be the ring of reals.

$G = \{[0, 9), *, (3, 6)\}$ be the special interval groupoid of type I. RG be the special interval ring of type I. QG be the subring of type I. QG is not an ideal of RG . ZG be the subring of type I. ZG is not an ideal of RG . We see RG has infinite number of subrings which are not ideals.

However RG has subrings which are ideals.

Example 4.93: Let $R = \{\langle C \cup I \rangle\}$ be the ring of neutrosophic complex numbers. $G = \{[0, 180), *, (10, 40)\}$ be the special interval groupoid of type I. RG be the groupoid ring. RG has infinite number of subrings which are not ideals.

$H = \{0, 10, 20, 30, \dots, 170\} \subseteq G$ is a special interval groupoid of type I. RH is the subring which is not an ideal.

Example 4.94: Let $S = \{\langle \mathbb{Z} \cup I \rangle\}$ be the neutrosophic ring of integers. $G = \{[0, 21), *, (7, 14)\}$ be the special interval groupoid of type I. SG be the groupoid ring of type I. SG has infinite number of subrings which are not ideals.

In fact $G = \langle n\mathbb{Z} \cup I \rangle$ be a subring of S . TG is the subring of SG which is an ideal of SG . SG has infinite number of zero divisors of the form $x = (a - aI)g_i$; $a \in \mathbb{Z}^+$ and $y = I(g_j)$; $g_i, g_j \in G$ are such that $x \times y = \{0\}$.

Example 4.95: Let $S = \{\langle \mathbb{R} \cup I \rangle\}$ be the neutrosophic ring. $G = \{[0, 29), *, (7, 22)\}$ be the special interval groupoid of type I. SG be the groupoid ring of type I. SG has infinite number of

zero divisors. SG has infinite number of subrings which are not ideals of SG. RG is only a subring and not an ideal of SG.

Example 4.96: Let $S = \langle \mathbb{Z} \cup I \rangle$ be the neutrosophic ring of integers $G = \{[0, 24), *, (10.8, 16.2)\}$ be the special interval groupoid of type II. SG be the groupoid ring of type II. SG has infinite number of subrings which are ideals. SG has infinite number of zero divisors.

One can study for RG the notion of Smarandache zero divisors, Smarandache units, Smarandache idempotents and Smarandache ideals.

Study in this direction is a matter of routine and is left as an exercise to the reader.

We suggest the following problems for this chapter.

Problems

1. Find some special features enjoyed by groupoid semiring SG where G is a groupoid of type I.
2. Let $SG = \left\{ \sum_{i=0}^n a_i x^i \mid a_i \in \mathbb{Z}^+ \cup \{0\}, x_i \in \{[0, 10), *, (2, 8)\} \right\}$
 $= G, 0 \leq i \leq n, n < \infty$ be the groupoid semiring.
 - (i) Prove SG is non associative.
 - (ii) Prove SG is non commutative.
 - (iii) Can SG have zero divisors?
 - (iv) Can SG have S-zero divisors?
 - (v) Can SG have units?
 - (vi) Can SG contain finite subsemirings?
3. Let $S = \mathbb{Q}^+ \cup \{0\}$ the semiring and $G = \{[0, 9), (4, 5), *\}$ be the interval groupoid of type I. SG be the groupoid semiring.

Study questions (i) to (vi) of problem two for this SG.

4. Let $S = \{\mathbb{R}^+ \cup \{0\}\}$ be the semiring
 $G = \{[0, 18), (9, 12), *\}$ be the interval groupoid of type I.
 SG be the groupoid semiring.

Study questions (i) to (vi) of problem two for this SG.

5. Let $S =$

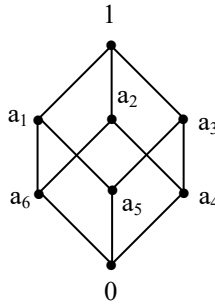

be the semiring of finite order. $G = \{[0, 28), (2, 26), *\}$ be the special interval groupoid of type I.
 SG be the groupoid semiring of infinite order and SG is non commutative and non associative.

- (i) Let $H = \{\mathbb{Z}_{28}, *, (2, 26)\} \subseteq G$ be the subgroupoid. Can H contribute to ideals if $|H| < \infty$?
- (ii) Find all ideals of SG.
- (iii) Can SG have ideals of finite order?
- (iv) Can SG have zero divisors which are not S-zero divisors?
- (v) Give all S-idempotents of SG.
- (vi) Can SG have S-units?
- (vii) Can SG have idempotents which are not S-idempotents?

6. Let $S =$

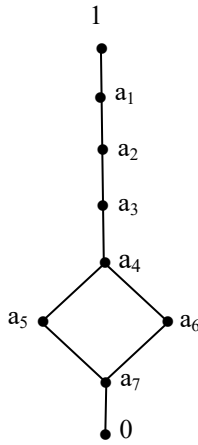

be the semiring of finite order. $G = \{[0, 19], *, (18, 2)\}$ be the special interval groupoid of type I. SG be the groupoid semiring of infinite order.

Study questions (ii) to (vii) of problem 5 for this SG.

7. Let $S =$

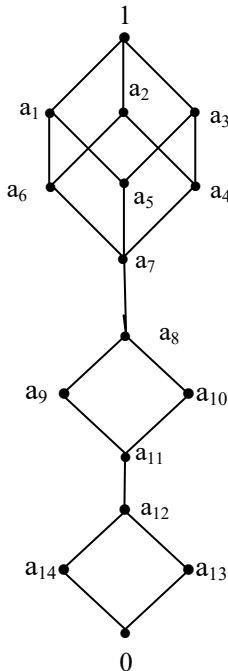

be the semiring of finite order. $G = \{[0, 22), *, (13, 10)\}$
 be the special interval groupoid of type I.
 SG be the groupoid semiring of the groupoid G over the
 semiring S.

Study questions (ii) to (vii) of problem 5 for this SG.

8. Let $S = B_1 \times B_2$ where

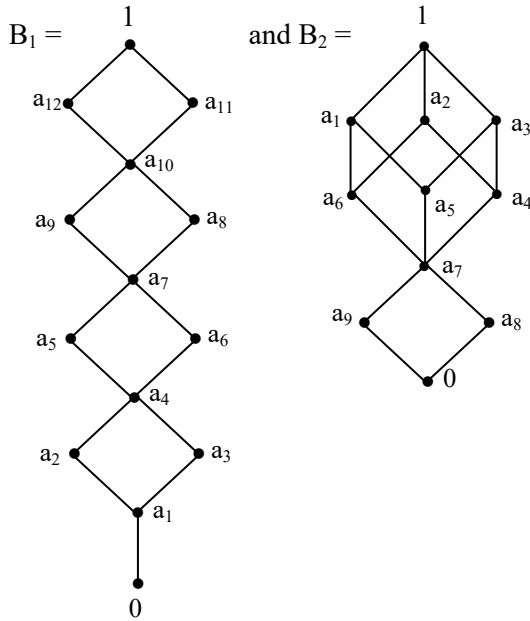

be the semiring of finite order. $G = \{[0, 20), *, (15, 5)\}$ be
 the special interval groupoid of type I.
 SG be the groupoid semiring of the groupoid G over the
 semiring S.

Study questions (ii) to (vii) of problem 5 for this SG.

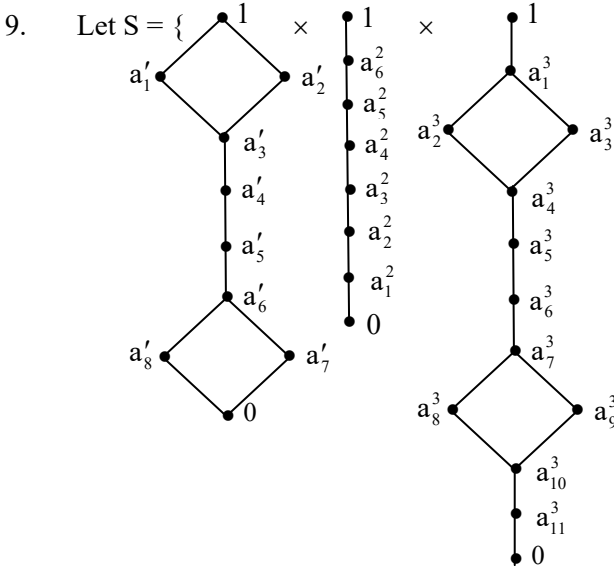

$= L_1 \times L_2 \times L_3$ be the semiring of finite order.

$G = \{[0, 15), (10, 0), *\}$ be the special interval groupoid of type I. SG be the groupoid semiring of the groupoid G over the semiring S.

Study questions (ii) to (vii) of problem 5 for this SG.

10. Let $S = \{Z^+ \cup \{0\}\}$ be the semiring. $G = \{[0, 9), *, (6, 3)\}$ be the special interval groupoid of type I. SG be the groupoid semiring of the groupoid G over the semiring.

Study questions (ii) to (vii) of problem 5 for this SG.

Show SG has infinite number of ideals of infinite order.

11. Let $S = \{Q^+ \cup \{0\}\}$ be the semiring and $G = \{[0, 39), (13, 26), *\}$ be the special interval groupoid of type I. SG be the groupoid semiring.

- (i) Study questions (ii) to (vii) of problem 5 for this SG.
- (ii) Can SG has ideals?
- (iii) Can SG have infinite number of subsemirings of infinite order?

12. Let $S = \{\mathbb{R}^+ \cup \{0\}\}$ be the semiring $G = \{[0, 24), *, (12, 8)\}$ be the special interval groupoid of type I. SG be the groupoid semiring of the groupoid G over the semiring S.

- (i) Study questions (ii) to (vii) of problem 5 for this SG.
- (ii) Can SG have ideals?
- (iii) Prove SG has infinite number of subsemirings.
- (iv) Can SG be finite subsemirings?

13. Let $S = \{[0, 27), \min, \max\}$ be the special interval semiring of infinite order. $G = \{[0, 27), *, (17, 10)\}$ be the groupoid of type I. SG be the groupoid semiring.

Study questions (i) to (iv) of problem 12 for this SG.

14. Let $V = \{[0, 48), \min, \max\}$ be the special interval semiring of infinite order. $G = \{[0, 18), *, (6, 9)\}$ be the groupoid of type I. VG be the groupoid semiring of the groupoid G over the semiring V.

Study questions (i) to (iv) of problem 12 for this SG.

15. Let $S = \{[0, 40), \min, \max\}$ be the special interval semiring. $G = \{[0, 40), *, (10, 30)\}$ be the special interval groupoid of type I.

Study questions (i) to (iv) of problem 12 for this SG.

16. Let $S = \{[0, 20), \min, \max\}$ be the special interval semiring $P = \{[0, 20), (10, 10), *\}$ be the special interval of groupoid of type I.

Study questions (i) to (iv) of problem 12 for this SG.

17. Obtain some special features enjoyed by the groupoid semirings using groupoids of type II built using $[0, n)$.
18. Let $S = \mathbb{R}^+ \cup \{0\}$ be the semiring and $G = \{[0, 20), *, (10.8, 16.4)\}$ be the special interval groupoid of type II. SG be the groupoid semiring of type II.
- (i) Can SG have zero divisors?
 - (ii) Can SG have S-units?
 - (iii) Is it possible for SG to have S-idempotents?
 - (iv) Can SG have subsemirings of finite order?
 - (v) Can SG have S-subsemirings?
 - (vi) Can SG have S-ideals?
 - (vii) Can SG have ideals which are not S-ideals?

19. Let $S = \{\mathbb{R}^+ \cup \{0\}\}$ be the semiring. $G = \{[0, 23), *, (17.2, 10.8)\}$ be the special interval groupoid of type II. SG be the groupoid semiring of type II.

Study questions (i) to (vii) of problem 18 for this SG.

20. Let $S = (\mathbb{R}^+ \cup \{0\})$ be the semiring. $G = \{[0, 18), *, (12.7, 10.3)\}$ be the special interval groupoid of type II. SG be the groupoid semiring.

Study questions (i) to (vii) of problem 18 for this SG.

21. Let $S = (\mathbb{Q}^+ \cup \{0\})$ be the semiring. $G = \{[0, 11), *, (10.75, 0)\}$ be the special interval groupoid of type II. SG be the groupoid semiring of type II.

Study questions (i) to (vii) of problem 18 for this SG.

22. Let $S = (\mathbb{R}^+ \cup \{0\})$ be the semiring.

$G = \{[0, 18), *, (12.7, 10.3)\}$ be the special interval groupoid of type II. SG be the groupoid semiring.

Study questions (i) to (vii) of problem 18 for this SG.

23. Let $S =$

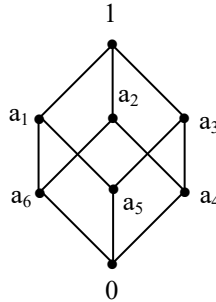

be the semiring. $G = \{[0, 9), *, (4.5, 4.5)\}$ be the groupoid of type II.

SG be the groupoid semiring of type II.

Study questions (i) to (vii) of problem 18 for this SG.

24. Let $S =$

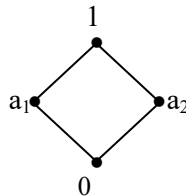

be the semiring.

$G = \{[0, 11), *, (5.5, 6.5)\}$ be the groupoid of type II. SG the groupoid semiring of type II.

Study questions (i) to (vii) of problem 18 for this SG.

25. Let $S =$

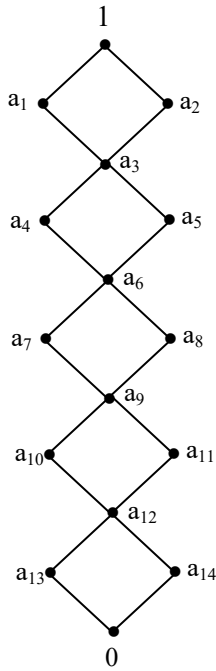

be the semiring. $G = \{[0, 26), *, (12.3, 13.7)\}$ be the groupoid of type II. SG be the groupoid semiring of the groupoid G over the semiring S .

Study questions (i) to (vii) of problem 18 for this SG .

26. Let $S =$

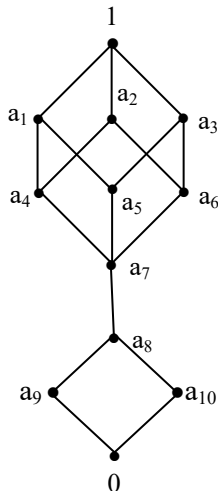

be the semiring. $G = \{[0, 11), *, (5.5, 5.5)\}$ be the special interval groupoid of type II. SG be the groupoid semiring of type II.

Study questions (i) to (vii) of problem 18 for this SG.

27. Let $S =$

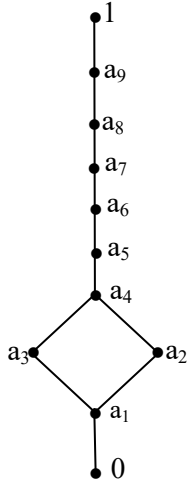

be the semiring of finite order and $G = \{[0, 21), *, (12.8312, 15.93107)\}$ be the special interval groupoid of infinite order of type II. SG be the groupoid semiring.

- (i) Can SG have zero divisors?
- (ii) Study questions (i) to (vii) of problem 18 for this SG.

28. Let $S =$

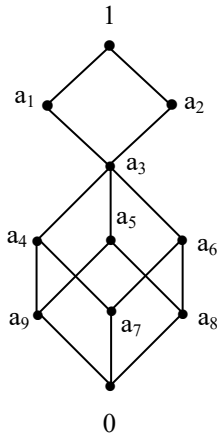

be the semiring of finite order

$G = \{[0, 24), *, (10.83715, 9.9231)\}$ be the special interval groupoid. SG be the groupoid semiring of type II.

- (i) Can SG have S-zero divisors?
- (ii) Is it ever possible for SG to have atleast zero divisors?
- (iii) Can SG have units?
- (iv) Is it possible for SG to have S-units?
- (v) Can SG ever have a S-idempotent?
- (vi) Is it possible for SG to have idempotents?

29. Let $S =$

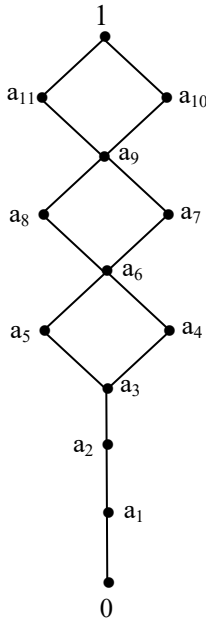

be the semiring of finite order.

$G = \{[0, 12), *, (8.009231, 4.173)\}$ be the special interval groupoid. SG be the groupoid semiring of type II.

Study questions (i) to (vi) of problem 28 for this SG.

30. Let $S =$

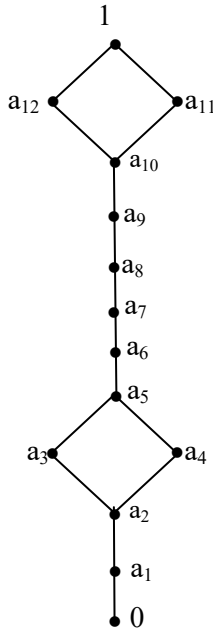

be the semiring of finite order.

$G = \{[0, 240), *, (127.8113, 158.3777)\}$ be the special interval groupoid of type II.

Study questions (i) to (vi) of problem 28 for this SG.

31. Let $S =$

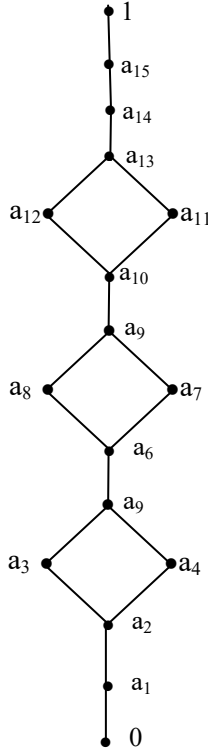

be the semiring of finite order.

$G = \{[0, 25), *, (2.000751, 13.8110067)\}$ be the special interval groupoid type II of infinite order. SG be the groupoid semiring of type II.

Study questions (i) to (vi) of problem 28 for this SG.

32. Let SG be the special interval groupoid semiring of type II where the semiring is a chain lattice of finite order.

Study questions (i) to (vi) of problem 28 for this SG.

33. Let $S =$

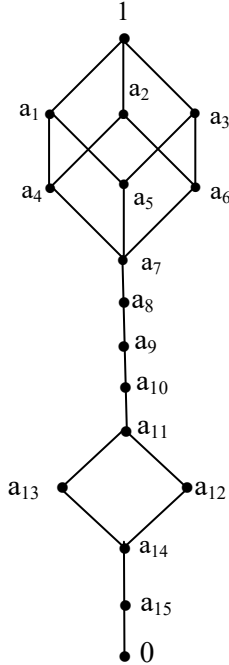

be finite distributive lattice. $G = \{[0, 17), *, (12.33132, 7.003151)\}$ be the special interval groupoid of type II. SG be the groupoid semiring of type II.

Study questions (i) to (vi) of problem 28 for this SG.

34. Let $S = C_{20}$ be the semiring $G = \{[0, 43), *, (20.0007173, 4.3001)\}$ be the special interval groupoid of type II. SG be the groupoid semiring of type II.

Study questions (i) to (vi) of problem 28 for this SG.

35. Let $S =$

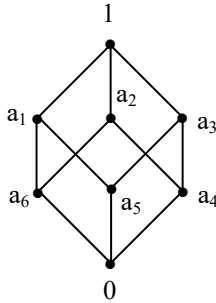

be the semiring. $G = \{[0, 12), *, (10.31107, 6.081351)\}$ be the special interval groupoid of type II. SG be the groupoid semiring of type II.

Study questions (i) to (vi) of problem 28 for this SG.

36. Let $S = \{\text{Boolean algebra of order } 2^5\}$ be the semiring $G = \{0, 25), *, (5.022161, 7.013)\}$ groupoid of type II. SG be the groupoid semiring of type II.

Study questions (i) to (vi) of problem 28 for this SG.

37. Let $G_1 = \{[0, 16), *, (10.3371, 9.88817)\}$ be the special interval groupoid of type II.

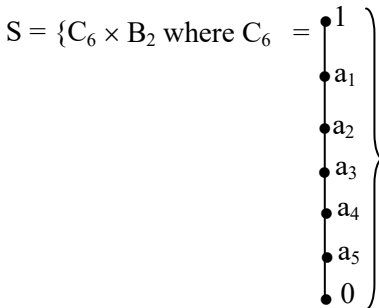

and $B_2 =$

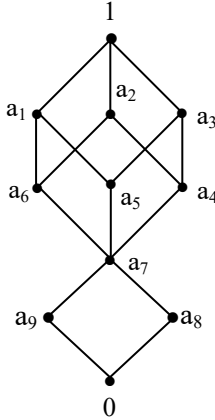

be the semiring of finite order. $S(G_1 \times G_2)$ be the special semiring of type II where $G_2 = \{[0, 7), *, (3.1111, 0.771)\}$ be the special interval groupoid of type II.

Study questions (i) to (vi) of problem 28 for this $S(G_1 \times G_2)$.

38. Let $S = \{\langle \mathbb{R}^+ \cup \{0\} \cup I \rangle\}$ be the neutrosophic semiring of infinite order. $G = \{[0, 20), *, (0.23101, 3.14751)\}$ be the special interval groupoid of type II. SG be the special interval groupoid semiring of type II. This semiring is neutrosophic non associative semiring of infinite order.
- (i) Can SG have zero divisors?
 - (ii) Is SG a semiring with S -units?
 - (iii) Can SG have S -zero divisors?
 - (iv) Is SG a S -semiring?
 - (v) Can SG have S -subsemirings?
 - (vi) Can SG have S -ideals?
 - (vii) Can SG have ideals which are not S -ideals?
 - (viii) Find all units which are not S -units.

39. Let $S = \{\langle \mathbb{Q}^+ \cup \{0\} \cup I \rangle\}$ be the neutrosophic semiring of infinite order. $G = \{[0, 18), *, (0.00517131, 6.10071)\}$ be the special interval groupoid of type II. SG be the neutrosophic semiring of infinite order .

Study questions (i) to (vi) of problem 38 for this SG.

40. Let $S = \{\langle \mathbb{R}^+ \cup \{0\} \cup I \rangle\}$ be the neutrosophic semiring of infinite order. $G = \{[0, 17), *, (0.8111, 19.20053)\}$ be the special interval groupoid of type II. SG be the neutrosophic semiring of infinite order.

Study questions (i) to (viii) of problem 38 for this SG.

41. Let $S = \{\langle \mathbb{Q}^+ \cup I \cup \{0\} \rangle\}$ be the neutrosophic semiring of infinite order. $G = \{[0, 120), *, (7.0041, 8.00053)\}$ be the special interval groupoid of type II. SG be the neutrosophic semiring of infinite order.

Study questions (i) to (viii) of problem 38 for this SG.

42. Let $S =$

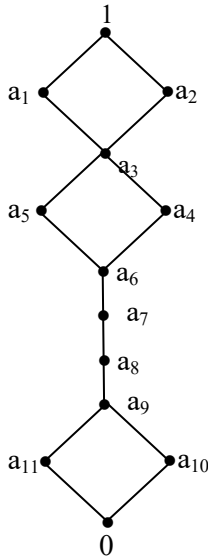

be the semiring $G = \{[0, 22), *, (11.000071, 11.00053)\}$
 be the special interval groupoid of type II. SG be the
 neutrosophic semiring of infinite order.

Study questions (i) to (viii) of problem 38 for this SG.

43. Let $S = L_1 \times L_2 \times L_3$ where

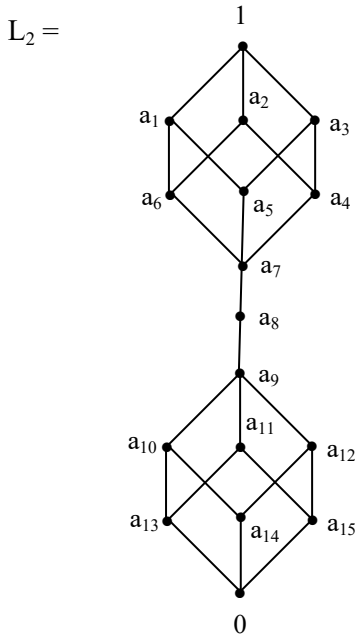
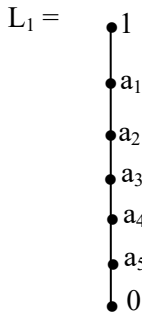

and $L_3 =$

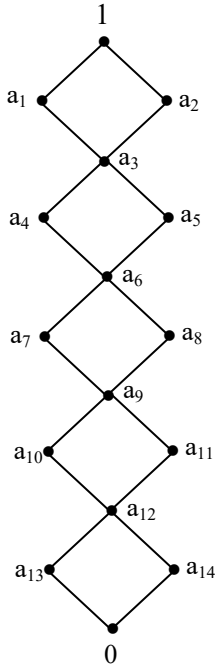

be the semiring of finite order

$G = \{[0, 21), *, (8.000023, 10.000097)\}$ be the special interval groupoid of type II. SG be the special groupoid semiring. Study questions (i) to (viii) of problem 38 for this SG.

44. Let

$S = \{(Z^+ \cup \{0\}) (g_1, g_2) \mid g_1^2 = 0, g_2^2 = g_2, g_1g_2 = g_2g_1 = 0\}$ be the semiring. $G = \{[0, 17), *, (6.000073, 15.00013)\}$ be the special interval groupoid of type II of infinite order. SG be the special interval groupoid semiring of infinite order.

Study questions (i) to (viii) of problem 38 for this SG.

45. Let $S = \{(Q^+ \cup \{0\}) (g_1, g_2, g_3, g_4) \mid g_i g_j = g_j g_i = 0, 1 \leq i, j \leq 4\}$ be the semiring. $G = \{[0, 16), *, (8.000013, 11.00053)\}$ be the special interval groupoid of type II. SG be the groupoid semiring of type II.

Study questions (i) to (viii) of problem 38 for this SG.

46. Let $S = \{(R^+ \cup \{0\}) (g_1, g_2, g_3) \mid g_1^2 = 0, g_3^2 = g_3 \text{ and } g_2^2 = g_2; g_i g_j = g_j g_i = 0, i \neq j, 1 \leq i, j \leq 3\}$ be the semiring of infinite order. $G = \{[0, 12), *, (3.00011, 6.000019)\}$ be the special interval groupoid of type II. SG be the groupoid over the semiring.

Study questions (i) to (viii) of problem 38 for this SG.

47. Let $S = \{(Q^+ \cup I \cup \{0\}) (g_1, g_2, g_3) \mid g_1^2 = 0; g_i g_j = g_j g_i = 0, 1 \leq i, j \leq 3\}$ be the semiring. $G = \{[0, 242), *, (0.00013, 0.0000017)\}$ be the special interval groupoid of type II. SG be the groupoid semiring of type II.

Study questions (i) to (viii) of problem 38 for this SG.

48. Let $R = \{Z_5\}$ be the ring $G = \{[0, 5), *, (2, 3)\}$ be the special interval groupoid of type I. RG be the groupoid ring of type I.

- (i) Can RG have zero divisors?
- (ii) Is RG a S-ring?
- (iii) Prove RG is non associative.
- (iv) Prove RG is non commutative.
- (v) Can RG have S-units?
- (vi) Can RG have S-idempotents?
- (vii) Can RG have ideals which are not S-ideals?
- (viii) Can RG have S-subrings?
- (ix) Find all right zero divisors which are not left zero divisors and vice versa.

49. Let $R = \{Z_{12}\}$ be the ring of modulo integers. $G = \{[0, 12), *, (0, 6)\}$ be the special interval groupoid of type I. RG be the groupoid ring of type I.

Study questions (i) to (ix) of problem 48 for this RG.

50. Let $R = \{Z_{15}\}$ be the ring of modulo integers.

$G = \{[0, 15), *, (10, 5)\}$ be the special interval groupoid of type I. RG be the groupoid ring of type I.

Study questions (i) to (ix) of problem 48 for this RG .

51. Let $R = \{Z_{19}\}$ be the ring of modulo integers. $G = \{[0, 16), *, (12, 4)\}$ be the special interval groupoid of type I. RG be the groupoid ring of type I.

Study questions (i) to (ix) of problem 48 for this RG .

52. Let $Z_{24} = R$ be the ring of modulo integers. $G = \{[0, 24), *, (12, 0)\}$ be the special interval groupoid of type I. RG be the groupoid ring of type I.

Study questions (i) to (ix) of problem 48 for this RG .

53. Let $R = \{Z_{45}\}$ be the ring of modulo integers. $G = \{[0, 45), *, (26, 20)\}$ be the special interval groupoid of type I. RG be the groupoid ring of type I.

Study questions (i) to (ix) of problem 48 for this RG .

54. Let $R = \{Z_{28}\}$ be the ring of modulo integers. $G = \{[0, 28), *, (14, 0)\}$ be the special interval groupoid of type I. RG be the groupoid ring of type I.

Study questions (i) to (ix) of problem 48 for this RG .

55. Let $R = \{Z_{49}\}$ be the ring of modulo integers. $G = \{[0, 49), *, (7, 7)\}$ be the special interval groupoid of type I. RG be the groupoid ring of type I.

Study questions (i) to (ix) of problem 48 for this RG .

56. Let $R = \{C(Z_{12})\}$ be the ring of modulo integers. $G = \{[0, 15), *, (3, 12)\}$ be the special interval groupoid of type I. RG be the groupoid ring of type I.

Study questions (i) to (ix) of problem 48 for this RG.

57. Let $R = \{\langle \mathbb{Z}_{15} \cup I \rangle\}$ be the ring of modulo integers. $G = \{[0, 15), *, (10, 5)\}$ be the special interval groupoid of type I. RG be the groupoid ring of type I.

Study questions (i) to (ix) of problem 48 for this RG.

58. Study RG' in problem 57 when G is replaced by $G' = \{[0, 15), *, (11, 5)\}$.

59. Let $R = \{\mathbb{Z}_{20}\}$ be the ring of modulo integers. $G = \{[0, 19), *, (17.2, 1.8)\}$ be the special interval groupoid of type I. RG be the groupoid ring of type II.

- (i) Can RG have subrings of finite order?
- (ii) Can RG have zero divisors?
- (iii) Prove all ideals in RG are of infinite order.
- (iv) Can RG have S-zero divisors?
- (v) Can RG have S-units?
- (vi) Is it possible for RG to have S-idempotents?

60. Let $R = \{\mathbb{Z}_{38}\}$ be the ring. $G = \{[0, 20), *, (10.37, 10.63)\}$ be the special interval groupoid of type II. RG be the groupoid ring of type II.

Study questions (i) to (vi) of problem 59 for this RG.

61. Let $R = \{\mathbb{Z}_{49}\}$ be the ring of integer. $G = \{[0, 14), *, (10.3, 2.7)\}$ be the special interval groupoid of type II. RG be the groupoid ring of type II.

Study questions (i) to (vi) of problem 59 for this RG.

62. Let $R = \{\mathbb{Z}_{40}\}$ be the ring of integer. $G = \{[0, 24), *, (12.3, 10.7)\}$ be the special interval groupoid of type II. RG be the groupoid ring of type II.

Study questions (i) to (vi) of problem 59 for this RG.

63. Let $R = \{Z_{10} \times Z_{16}\}$ be the ring.
 $G = \{[0, 42), *, (27.3.3, 20)\}$ be the special interval groupoid of type II. RG be the groupoid ring of type II.

Study questions (i) to (vi) of problem 59 for this RG .

64. Let $R = \{Z \cup I\}$ be the ring.
 $G = \{[0, 7), *, (3.37, 3.63)\}$ be the special interval groupoid of type II. RG be the groupoid ring of type II.

Study questions (i) to (vi) of problem 59 for this RG .

65. Let $R = \{Q \cup I\}$ be the ring.
 $G = \{[0, 70), *, (35.1, 35.9)\}$ be the special interval groupoid of type II. RG be the groupoid ring of type II.

- (i) Find all subrings of RG which are not ideals of RG .
- (ii) Find S -ideals in RG .
- (iii) Does there exists ideals which are not S -ideals in RG ?
- (iv) Can RG have S -subring?
- (v) Is it possible for RG to have finite order ideals?
- (vi) Can RG have finite subrings?

66. Let $R = \{C \cup I\}$ be the ring. $G = \{[0, 32), *, (36.2, 8)\}$ be the special interval groupoid of type II. RG be the groupoid ring of type II.

- (i) Study questions (i) to (vi) of problem 65 for this RG .
- (ii) Study questions (i) to (vi) of problem 59 for this RG .

67. Let $R = \{Z(g_1, g_2, g_3) \mid g_1^2 = 0, g_2^2 = g_2, g_3^2 = -g_3, g_i g_j = g_j g_i; i \neq j, 1 \leq i, j \leq 3\}$ be the ring of special quasi dual numbers. $G = \{[0, 28), *, (14.3, 14.7)\}$ be the special interval groupoid of type II. RG be the groupoid ring of type II.

- (i) Study questions (i) to (vi) of problem 59 for this RG.
 - (ii) Study questions (i) to (vi) of problem 65 for this RG.
68. Let $R = \langle \mathbb{Q} \cup \mathbb{I} \rangle$ be the ring.
 $G = \{[0, 26), *, (3.02, 6.15)\}$ be the special interval groupoid of type II. RG be the groupoid ring of type II.
- (i) Study questions (i) to (vi) of problem 65 for this RG.
 - (ii) Study questions (i) to (vi) of problem 59 for this RG.
69. Let $R = \{C(\mathbb{Z}_6) \times \mathbb{Z}_7\}$ be the ring.
 $G = \{[0, 6), *, (3.33, 6.66)\}$ be the special interval groupoid of type II. RG be the groupoid ring of type II.
- (i) Study questions (i) to (vi) of problem 65 for this RG.
 - (ii) Study questions (i) to (vi) of problem 59 for this RG.
70. Characterize those groupoid rings of type II which has only finite number zero divisors.
71. Does there exist a groupoid ring of type II which has no S-ideals?
72. Find groupoid ring RG of type I which has S-idempotents.
73. Does there exist a groupoid ring of type I which has no S-zero divisors?
74. Let $R = \langle \mathbb{Z} \cup \mathbb{I} \rangle$ be the ring. $G = \{[0, 29), *, (20, 9)\}$ be the special interval groupoid of type I. RG be the groupoid ring of type II.
- (i) Is RG a S-ring?
 - (ii) Can RG have S-ideals?
 - (iii) Can RG have a S-subring which is not a S-ideal?
 - (iv) Can RG have S-units?
 - (v) Can RG have S-zero divisors?
 - (vi) Can RG have S-idempotents?

(vii) Does RG contain idempotents which has no S -idempotents?

75. Let $R = \{Z_{25} \times Z_{12}\}$ be the ring of integers. $G = \{[0, 11), *, (10.5, 2.5)\}$ be special interval groupoid of type II. RG be the groupoid ring of type II.

Study questions (i) to (vii) of problem 74 for this RG .

76. Let $R = \{CZ_{16}\}$ be the ring. $G = \{[0, 17), *, (3.3, 16.7)\}$ be the special interval groupoid of type II. RG be the groupoid ring of type II.

Study questions (i) to (vii) of problem 74 for this RG .

77. Characterize those groupoid rings of type II which are not S -rings of type II.

78. Characterize those groupoid rings of type II which have no S -ideals.

79. Characterize those groupoid rings of type II which have no S -units?

80. Characterize those groupoid rings of type II which has S -idempotents.

81. Characterize those groupoid rings of type II which has S -zero divisors.

82. Characterize those groupoid rings of type I which has S -zero divisors.

83. Characterize those groupoid rings type I which has finite S -subrings.

84. Characterize those groupoid rings of type I which are not S -rings.

FURTHER READING

1. Birkhoff. G, *Lattice theory*, 2nd Edition, Amer-Math Soc. Providence RI 1948.
2. Birkhoff. G., and Maclane, S.S., *A Brief Survey of Modern Algebra*, New York, The Macmillan and Co. (1965).
3. Bruck, R.H., *A Survey of binary systems*, Berlin Springer Verlag, (1958).
4. Castillo, J., *The Smarandache Semigroup*, International Conference on Combinatorial Methods in Mathematics, II Meeting of the project 'Algebra, Geometria e Combinatoria', Faculdade de Ciencias da Universidade do Porto, Portugal, 9-11 July 1998.
5. Nivan, Ivan and Zukerman, H.S., *Introduction to number theory*, Wiley Eastern Limited, (1989).
6. Padilla, R., *Smarandache Algebraic Structures*, Bulletin of Pure and Applied Sciences, Delhi, Vol. 17 E, No. 1, 119-121, (1998).
7. Padilla, R., *Smarandache Algebraic Structures*, Smarandache Notions Journal, USA, Vol.9, No. 1-2, 36-38, (1998).
8. R.Lidl and G. Pilz, *Applied Abstract Algebra*, Springer Verlag, (1984).
9. Smarandache, Florentin (editor), *Proceedings of the First International Conference on Neutrosophy, Neutrosophic Logic, Neutrosophic set, Neutrosophic probability and Statistics*,

December 1-3, 2001 held at the University of New Mexico, published by Xiquan, Phoenix, 2002.

10. Smarandache, Florentin, A Unifying field in Logics: Neutrosophic Logic, Neutrosophy, Neutrosophic set, Neutrosophic probability, second edition, American Research Press, Rehoboth, 1999.
11. Smarandache, Florentin, An Introduction to Neutrosophy, <http://gallup.unm.edu/~smarandache/Introduction.pdf>
12. Smarandache, Florentin, *Collected Papers II*, University of Kishinev Press, Kishinev, 1997.
13. Smarandache, Florentin, *Neutrosophic Logic, A Generalization of the Fuzzy Logic*, <http://gallup.unm.edu/~smarandache/NeutLog.txt>
14. Smarandache, Florentin, *Neutrosophic Set, A Generalization of the Fuzzy Set*, <http://gallup.unm.edu/~smarandache/NeutSet.txt>
15. Smarandache, Florentin, *Neutrosophy : A New Branch of Philosophy*, <http://gallup.unm.edu/~smarandache/Neutroso.txt>
16. Smarandache, Florentin, *Special Algebraic Structures, in Collected Papers III*, Abaddaba, Oradea, 78-81, 2000.
17. Smarandache. F. (editor), *Proceedings of the First International Conference on Neutrosophy*, Neutrosophic Probability and Statistics, Univ. of New Mexico-Gallup, 2001.
18. Vasantha Kandasamy, W.B., *Groupoids and Smarandache Groupoids*, American Research Press, Rehoboth, 2002.
19. Vasantha Kandasamy, W.B., *Linear Algebra and Smarandache Linear Algebra*, Bookman Publishing, US, 2003.
20. Vasantha Kandasamy, W.B., *New classes of finite groupoids using Z_n* , Varahmihir Journal of Mathematical Sciences, Vol 1, 135-143, (2001).
21. Vasantha Kandasamy, W.B., *On Ordered Groupoids and its Groupoid Rings*, Jour. of Maths and Comp. Sci., Vol 9, 145-147, (1996).

22. Vasantha Kandasamy, W.B., *Smarandache Automaton*, <http://www.gallup.unm.edu/~smarandache/Automaton.pdf>
23. Vasantha Kandasamy, W.B., *Smarandache Groupoids*, <http://www.gallup.unm.edu/~smarandache/Groupoids.pdf>.
24. Vasantha Kandasamy, W.B., *Smarandache Loops*, American Research Press, Rehoboth, 2002.
25. Vasantha Kandasamy, W.B., *Smarandache Rings*, American Research Press, Rehoboth, 2002.
26. Vasantha Kandasamy, W.B., *Smarandache Semigroups*, American Research Press, Rehoboth, 2002.
27. Vasantha Kandasamy, W.B., *Smarandache Semirings, Semifields and Semivector spaces*, American Research Press, Rehoboth, 2002.
28. Vasantha Kandasamy, W.B., and Smarandache, Florentin, *Fuzzy Interval Matrices, Neutrosophic Interval Matrices and their Applications*, Hexis, Phoenix, 2006.
29. Vasantha Kandasamy, W.B. and Florentin Smarandache, *Neutrosophic Rings*, Hexis, Arizona, 2006.
30. Vasantha Kandasamy, W.B. and Florentin Smarandache, *Set Linear Algebra and Set Fuzzy Linear Algebra*, InfoLearnQuest, Phoenix, 2008.
31. Vasantha Kandasamy, W.B. and Florentin Smarandache, *Interval Groupoids*, InfoLearnQuest, Phoenix, 2010.
32. Vasantha Kandasamy, W.B. and Florentin Smarandache, *Finite Neutrosophic Complex Numbers*, Zip Publishing, Ohio, 2011.
33. Vasantha Kandasamy, W.B. and Florentin Smarandache, *Dual Numbers*, Zip Publishing, Ohio, 2012.
34. Vasantha Kandasamy, W.B. and Florentin Smarandache, *Natural Product \times_n on matrices*, Zip Publishing, Ohio, 2012.
35. Vasantha Kandasamy, W.B. and Florentin Smarandache, *Quasi Set Topological Vector Subspaces*, Educational Publisher Inc, Ohio, 2012.

36. Vasantha Kandasamy, W.B. and Florentin Smarandache, *Set Ideal Topological Spaces*, Zip Publishing, Ohio, 2012.
37. Vasantha Kandasamy, W.B. and Florentin Smarandache, *Special dual like numbers and lattices*, Zip Publishing, Ohio, 2012.
38. Vasantha Kandasamy, W.B. and Florentin Smarandache, *Special quasi dual numbers and groupoids*, Zip Publishing, Ohio, 2012.
39. Vasantha Kandasamy, W.B. and Florentin Smarandache, *Algebraic Structures using Subsets*, Educational Publisher Inc, Ohio, 2013.
40. Vasantha Kandasamy, W.B. and Florentin Smarandache, *Subsets Groupoids*, Educational Publisher Inc, Ohio, 2013.
41. Vasantha Kandasamy, W.B. and Florentin Smarandache, *Subset Polynomial Semirings and Subset Matrix Semirings*, Educational Publisher Inc, Ohio, 2013.
42. Vasantha Kandasamy, W.B. and Florentin Smarandache, *Algebraic Structures using $[0, n)$* , Educational Publisher Inc, Ohio, 2013.

INDEX

G

- Groupoid of type I, 7-35
- Groupoid of type II, 45-60

S

- S-conjugate subgroupoids, 25-30
- Smarandache semi conjugate subgroupoids, 24-32
- Smarandache special interval groupoid of type I, 23-30
- Smarandache special left ideal, 24-30
- Smarandache special subgroupoid, 24-32
- Smarandache special right ideal, 24-30
- S-normal groupoid, 25-30
- Special interval groupoid of type I, 9-30
- Special interval groupoid ring of type I, 133-140
- Special interval groupoid ring of type II, 141-159
- Special interval groupoid semiring of type I, 98-120
- Special interval groupoid semiring of type II, 121-130
- Special interval quasi groupoid of type II, 50-8
- S-quasi special interval Moufang groupoid, 25-31
- S-quasi special interval strong Moufang groupoid, 25-31
- S-quasi special interval strong Bol groupoids, 26-32
- S-special conjugate weakly subgroupoid, 25-32
- S-special interval simple groupoid of type I, 32
- S-special interval strong idempotent groupoid of type I, 30-2
- S-special strong alternative groupoid, 30
- S-special strong P-groupoid, 30

W

- Weakly S-seminormal subgroupoid, 25-30
- Weakly S-special interval normal groupoid, 25-30

ABOUT THE AUTHORS

Dr.W.B.Vasantha Kandasamy is a Professor in the Department of Mathematics, Indian Institute of Technology Madras, Chennai. In the past decade she has guided 13 Ph.D. scholars in the different fields of non-associative algebras, algebraic coding theory, transportation theory, fuzzy groups, and applications of fuzzy theory of the problems faced in chemical industries and cement industries. She has to her credit 646 research papers. She has guided over 100 M.Sc. and M.Tech. projects. She has worked in collaboration projects with the Indian Space Research Organization and with the Tamil Nadu State AIDS Control Society. She is presently working on a research project funded by the Board of Research in Nuclear Sciences, Government of India. This is her 93rd book.

On India's 60th Independence Day, Dr.Vasantha was conferred the Kalpana Chawla Award for Courage and Daring Enterprise by the State Government of Tamil Nadu in recognition of her sustained fight for social justice in the Indian Institute of Technology (IIT) Madras and for her contribution to mathematics. The award, instituted in the memory of Indian-American astronaut Kalpana Chawla who died aboard Space Shuttle Columbia, carried a cash prize of five lakh rupees (the highest prize-money for any Indian award) and a gold medal.

She can be contacted at vasanthakandasamy@gmail.com

Web Site: http://mat.iitm.ac.in/home/wbv/public_html/

or <http://www.vasantha.in>

Dr. Florentin Smarandache is a Professor of Mathematics at the University of New Mexico in USA. He published over 75 books and 200 articles and notes in mathematics, physics, philosophy, psychology, rebus, literature. In mathematics his research is in number theory, non-Euclidean geometry, synthetic geometry, algebraic structures, statistics, neutrosophic logic and set (generalizations of fuzzy logic and set respectively), neutrosophic probability (generalization of classical and imprecise probability). Also, small contributions to nuclear and particle physics, information fusion, neutrosophy (a generalization of dialectics), law of sensations and stimuli, etc. He got the 2010 Telesio-Galilei Academy of Science Gold Medal, Adjunct Professor (equivalent to Doctor Honoris Causa) of Beijing Jiaotong University in 2011, and 2011 Romanian Academy Award for Technical Science (the highest in the country). Dr. W. B. Vasantha Kandasamy and Dr. Florentin Smarandache got the 2012 New Mexico-Arizona and 2011 New Mexico Book Award for Algebraic Structures. He can be contacted at smarand@unm.edu

Study of algebraic structures built using $(0, n)$ happens to be one of an interesting and innovative research. Here we define two types of groupoids using $(0, n)$ both of them are of infinite order. It is an open conjecture to find whether these new class of groupoids satisfy any of the special identities like Moufang identity or Bol identity and so on.

US \$35.00
Educational
Publisher Inc.

