

# MATHEMATICAL REALITY

— *My Philosophy on Mathematics with Reality*

Linfan MAO

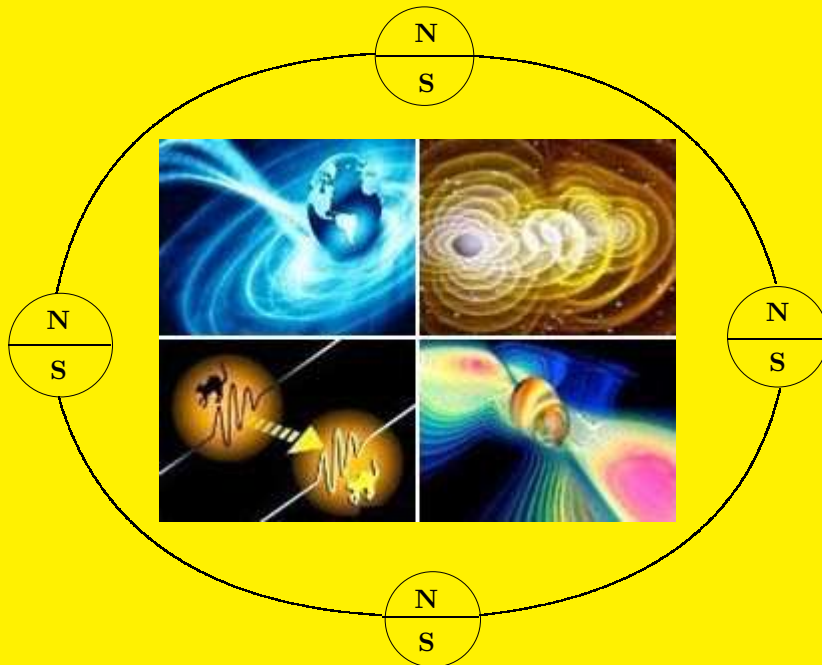

The Education Publisher Inc.

2018

**Dr.Linfan MAO**

Chinese Academy of Mathematics and System Science, P.R.China

International Academy of Mathematical Combinatorics & Applications, USA

Email: *maolinfan@163.com*

# Mathematical Reality

— *My Philosophy on Mathematics with Reality*

**The Education Publisher Inc.**

**2018**

This book can be ordered in a paper bound reprint from:

**Books on Demand**

ProQuest Information & Learning  
(University of Microfilm International)  
300 N.Zeeb Road  
P.O.Box 1346, Ann Arbor  
MI 48106-1346, USA  
Tel:1-800-521-0600(Customer Service)  
<http://wwwlib.umi.com/bod>

**Peer Reviewers:**

F.Smarandache, Department of Mathematics, University of New Mexico - Gallup, USA.

F.Tian, Academy of Mathematics and Systems, Chinese Academy of Sciences, Beijing 100190,  
P.R.China.

Arindam Bhattacharyya, Department of Mathematics, Jadavpur University, Kolkata-700032,  
India.

H.Ren, East China Normal University, Shanghai 200062, P.R.China.

**Copyright** 2018 by The Education Publisher Inc. and Linfan MAO

Many books can be downloaded from the following **Digital Library of Science:**

<http://www.gallup.unm.edu/~smarandache/eBooks-otherformats.htm>

**ISBN:** 9781599735764

**Price:** 85\$

# Reality: To Be or Not To Be

## ( Preface )

A thing is complex, and hybrid with other things sometimes. Then, *what is the reality of a thing?* The reality of a thing is its state of existed, exists, or will exist in the world, independent on the understanding of human beings, which implies that the reality holds on by human beings maybe local or gradual, not the reality of a thing. Hence, to hold on the reality of things is the main objective of science in the history of human development.

One of the main function of mathematics in science is it can establish exact mathematical expressions for scientific models on things. Observing and collecting measurements, as well as the hypothesizing and predicting often require extensive applying mathematical techniques, including mathematical physics, mathematical chemistry, mathematical biology, mathematical finance, and mathematical economics, i.e., the reality of things by human beings is mostly dependent on mathematical reality.

But, *a mathematical conclusion really reflects the reality of a thing?* The answer is not certain because the practices of human beings show the mathematical conclusion do not correspond to the reality of a thing sometimes, for instance the *Ames Room*. Usually, the understanding of a thing is by observation of human beings, which is dependent on the observable model, data collection by scientific instruments with data processing by mathematics. Such a observation brings about a unilateral, or an incomplete knowledge on a thing. In this case, the mathematical conclusion reflects partial datum, not all the collection, and in fact, all collection data (by different observers with different model) with data processed is not a mathematical system, even with contradictions in usual unless a data set, which implies that there are no mathematical subfields applicable. In recent years, there are more and more examples supporting this claim with social development.

**Physics.** The matters consist of two classes particles, i.e., bosons with integer spin  $n$ , fermions with fractional spin  $n/2$ ,  $n \equiv 1(\text{mod}2)$ , and by a widely held view, the elementary particles consists of quarks, leptons with interaction quanta including photons and other particles of mediated interactions ([16]), which constitute hadrons, i.e., mesons, baryons and their antiparticles. Thus, a hadron has an internal structure, which implies that all hadrons are not elementary but leptons are, viewed as point particles in elementary physics ([2],[3]). The quark model is a formal classification scheme for hadrons in terms of quarks, i.e., the quarks and antiquarks, which completely changed the usual notion that a hadron is a geometrical abstract point or a subset of space for characterizing its behavior. For example, a baryon is predominantly formed by three quarks, and a meson is mainly composed of a quark and an antiquark in quark models of Sakata, or Gell-Mann and Ne'eman. But a free quark was never found in experiments. Thus, the quark model is only a model for classifying hadrons motivated by physicists. However, it opened a new way for understanding the reality of a hadron in notion, i.e., we are not need to insist again that a hadron is a geometrical point or a subset of space

such as those of assumptions in determinable science.

**Biology.** The biological populations are dependent each other by food web, i.e., a natural interconnection of food chains and a graphical representation of what-eats-what in an ecological community on the earth. For example, a food chain starts from producer organisms (such as grass or trees which use radiation from the sun to make their food) and end at apex predator species (like grizzly bears or killer whales), detritivores (like earthworms or woodlice), or decomposer species (such as fungi or bacteria). Usually, a model of a biological system is converted into a system of equations. The solution of the equations, by either analytical or numerical means, describes how the biological system behaves either over time or at equilibrium. In fact, a food web is an interaction system in physics which can be mathematically characterized by the strength of what action on what. For a biological 2-system, let  $x$ ,  $y$  be the two species with the action strength  $F'(x \rightarrow y)$ ,  $F'(y \rightarrow x)$  of  $x$  to  $y$  and  $y$  to  $x$  on their growth rate, ([1]). Such a biological 2-system can be quantitatively characterized by differential equations

$$\begin{cases} \dot{x} = F'(y \rightarrow x) \\ \dot{y} = F'(x \rightarrow y) \end{cases}$$

on the populations of species  $x$  and  $y$ . However, this method can be only applied to the small number ( $\leq 3$ ) of populations in this web. If the number of populations  $\geq 4$ , one can not get the solution of equations in general and can be only by data approximating simulation. Thus, even in mathematical biology one has no a mathematical branch applicable for the reality of biology unless differential equations and statistical analysis.

**Economy.** Today, the world trade rules enables each one of his member develops extensively on other members. Achieving mutual benefit, and finally striving for trade balance is the purpose of the world or regional trade organization. This situation appears both in the global or area economy because there are few countries or areas still in self-sufficient today. The trade surplus and deficit usually result in the trade disputing in members, processes the multilateral negotiations, and then reach a new ruler for members in the international trade. Usually, one can obtains statistical data published by customs or statistical services in a country or an area, but there are no a mathematical subfield for characterizing the global or local changing in economy.

Certainly, we can easily get other fields that there are no mathematical subfields applicable. For example, the complex network, including community network, epidemic spreading network with their behaviors. Then, *can one holds the reality of things?* For this question, there are always two answers. One is the reality of things can not completely understanding, i.e., one can only holds on the approximate reality of things. Another is one can finally understanding the reality of things by Theory of Everything.

For the first answer, there is a well-known philosophical book: *TAO TEH KING* written by an ideologist *Lao Zi* in ancient China. In this book, it discussed extensively on the relation of *TAO* with name and things, shown in its first but central chapter ([4]):

The Tao that experienced is not the eternal Tao;  
The Name named is not the eternal Name;

The unnamable is the eternally real and naming is the origin of all particular things;  
 Freely desire, you realize the mystery but caught in desire, you see only the manifestations;  
 The mystery and manifestations arise from the same source called darkness;  
 The darkness within darkness, the gateway to all understanding.

Therefore, it is difficult to know the reality of all things according to Lao Zi, and all mathematical reality is only approximate reality.

The second answer is the main trending in scientific community today, i.e., the physical world is nothing else but a mathematical structure ([6]). That is to say, mathematical reality is the reality of things.

Generally, the reality of a thing is an interaction system in an micro world view, and if one enters the internal of the thing, the equations established on the observing datum usually are non-solvable, or contradictory. However, the trend of mathematical developing in 20th century shows that a mathematical system is more concise, and its conclusion is more extended, then farther to the reality of things because it abandons more and more characters of things, and in logic, each mathematical subfield should be in coordination, i.e., without contradictions. This result implies that even if the physical world is a mathematical structure, one can only understand partial or local reality by classical mathematics.

For establishing the mathematical model on the reality of things, there are two questions should be solved. One is the contradiction between things, i.e., different things should be in equal rights, and another is the dependence of things. Today, we have known a kind geometry breaking through the non-contradiction in classical mathematics, i.e., *Smarandache geometry* (1969) by introducing a new type axiom for space. An axiom is said to be *Smarandachely denied* if the axiom behaves in at least two different ways within the same space, i.e., validated and invalidated, or only invalidated but in multiple distinct ways. A Smarandache geometry [6] is a geometry which has at least one Smarandachely denied axiom (1969). If  $\mathcal{A}$  is a Smarandache denied axiom on space  $\mathcal{T}$ , then all points in  $\mathcal{T}$  with  $\mathcal{A}$  validated or invalidated consist of points sets  $T^{H(\mathcal{A})}$  and  $T^{N(\mathcal{A})}$ , and if it is in multiple distinct ways invalidated, without loss of generality, let  $s$  be its multiplicity. Then all points of  $\mathcal{T}$  are classified into  $T_1^{\mathcal{A}}, T_2^{\mathcal{A}}, \dots, T_s^{\mathcal{A}}$ . Hence, we get a partition on points of space  $\mathcal{T}$  as follow:

$$\mathcal{T} = T^{H(\mathcal{A})} \cup T^{N(\mathcal{A})}, \quad \text{or} \quad \mathcal{T} = T_1^{\mathcal{A}} \cup T_2^{\mathcal{A}} \cup \dots \cup T_s^{\mathcal{A}}.$$

This shows that  $\mathcal{T}$  should be a Smarandache multispace.

Generally, let  $(\Sigma_1; \mathcal{R}_1), (\Sigma_2; \mathcal{R}_2), \dots, (\Sigma_m; \mathcal{R}_m)$  be  $m$  mathematical spaces, different two by two. A *Smarandache multispace*  $\tilde{\Sigma}$  is a union  $\bigcup_{i=1}^m \Sigma_i$  with rules  $\tilde{\mathcal{R}} = \bigcup_{i=1}^m \mathcal{R}_i$  on  $\tilde{\Sigma}$ , i.e., the rule  $\mathcal{R}_i$  on  $\Sigma_i$  for integers  $1 \leq i \leq m$  ([2],[8]). Thus, the reality of things, even approximate should be characterized or found out on Smarandache multispaces. Certainly, a Smarandache multispace inherited a graph structure (intersection graph)  $G^L[\tilde{\Sigma}]$ , labeled its each vertex by  $\Sigma_i$ . Thus, the Smarandache multispace solved better the contradiction in classical mathematics. However, an abstract Smarandache multispace is nothing else but an algebraic or set problem ([8]), and can not extensively applies achievements in classical mathematics. Thus, for understanding the reality of things, a new envelope theory should be established on Smarandache multispace, i.e., *mathematical combinatorics*.

*What is mathematical combinatorics?* The mathematical combinatorics is such a mathematics over topological graphs  $\vec{G}$ . And *how to combine classical mathematics with topological graphs  $\vec{G}$ ?* I found a typical set of labeled graphs  $\vec{G}^L$  can be viewed as mathematical elements, i.e., labeling their edges by elements in a Banach space  $\mathcal{B}$  with two end-operators on  $\mathcal{B}$  and holding on the continuity equation on each vertex in  $\vec{G}$ . Then, such a set of labeled graphs  $\vec{G}^L$  inherits the character of classical mathematics, i.e., if  $\vec{G}_1, \vec{G}_2, \dots, \vec{G}_n$  are oriented topological graphs and  $\mathcal{B}$  a Banach space, then all such labeled graphs  $\vec{G}^L$  with linear end-operators is also a Banach space, and furthermore, if  $\mathcal{B}$  is a Hilbert space, all such labeled graphs  $\vec{G}^L$  with linear end-operators is a Hilbert space too. This fact enables one to apply achievements of classical mathematics in mathematical combinatorics, which can be find in this book.

As the time enters the 21st century, sciences such as those of theoretical physics, complex system and network, cytology, biology and economy developments change rapidly, and meanwhile, a few global questions constantly emerge, such as those of local war, food safety, epidemic spreading network, environmental protection, multilateral trade dispute, more and more questions accompanied with the overdevelopment and applying the internet,  $\dots$ , etc. In this case, *how to keep up mathematics with the developments of other sciences?* Clearly, today's mathematics is no longer adequate for the needs of other sciences. New mathematical theory or techniques should be established by mathematicians. Certainly, solving problem is the main objective of mathematics, proof or calculation is the basic skill of a mathematician. When it develops in problem-oriented, a mathematician should makes more attentions on the reality of things in mathematics because it is the main topic of human beings.

## References

- [1] Fred Brauer and Carlos Castillo-Chaver, *Mathematical Models in Population Biology and Epidemiology*(2nd Edition), Springer, 2012.
- [2] Linfan Mao, *Smarandache Multi-Space Theory*, The Education Publisher Inc., USA, 2011.
- [3] Y.Nambu, *Quarks: Frontiers in Elementary Particle Physics*, World Scientific Publishing Co.Pte.Ltd, 1985.
- [4] Quang Ho-Kim and Pham Xuan Yem, *Elementary Particles and Their Interactions*, Springer-Verlag Berlin Heidelberg, 1998.
- [5] Z.Sima, Completely TAO TEH KING (in Chinese), China Changan Publisher, Beijing, 2007.
- [6] F.Smarandache, Multi-space and multi-structure, in *Neutrosophy. Neutrosophic Logic, Set, Probability and Statistics*, American Research Press, 1998.
- [7] F.Smarandache, *Paradoxist Geometry*, State Archives from Valcea, Rm. Valcea, Romania, 1969, and in *Paradoxist Mathematics*, Collected Papers (Vol. II), Kishinev University Press, Kishinev, 5-28, 1997.
- [8] W.B.Vasantha Kandasamy and F.Smarandache, *N-Algebraic Structures and S-N-Algebraic Structures*, HEXIS, Phoenix, Arizona, 2005.
- [9] M.Tegmark, Parallel universes, in *Science and Ultimate Reality: From Quantum to Cosmos*, ed. by J.D.Barrow, P.C.W.Davies and C.L.Harper, Cambridge University Press, 2003.

## Content

<b>Preface</b> .....	i
<b>Chapter 1 Mathematics with Reality</b> .....	1
1.1 Complex Flows with Synchronization.....	2
1.2 Mathematics with natural reality – Action flows.....	25
1.3 Mathematical combinatorics with natural reality.....	43
1.4 A new understanding of particles by $\vec{G}$ -flow interpretation of differential equation.....	63
1.5 A review on natural reality with physical equations.....	71
<b>Chapter 2 Contradiction with Reality</b> .....	77
2.1 Mathematics on non-mathematics.....	78
2.2 Non-solvable spaces of linear equation systems.....	115
2.3 Global stability of non-solvable ordinary differential equations with applications.....	129
2.4 Cauchy problem on non-solvable system of first order partial differential equations with applications.....	163
2.5 Geometry on non-solvable equations - A review on contradictory systems.....	192
<b>Chapter 3 Combinatorial Notion on Reality</b> .....	213
3.1 Combinatorial speculation and combinatorial conjecture for mathematics.....	214
3.2 Mathematics after CC conjecture-Combinatorial notions and achievements.....	233
<b>Chapter 4 Envelope Mathematics on Reality</b> .....	234
4.1 Extended Banach $\vec{G}$ -flow spaces on differential equations with applications.....	235
4.2 Hilbert flow spaces with operators over topological graphs.....	278
4.3 Labeled graph – A mathematical element.....	305
<b>Chapter 5 Combinatorial Models on Reality</b> .....	334
5.1 Combinatorial fields - An introduction.....	335
5.2 Curvature equations on combinatorial manifolds with applications to	



theoretical physics .....	357
5.3 Relativity in combinatorial gravitational fields .....	376
5.4 Biological $n$ -system with global stability.....	387
5.5 A topological model for ecologically industrial systems .....	415

## Chapter 1 Mathematics with Reality



*Why fails to see the true face of Lushan mountain,  
Because he is just in these mountains.*

By SuShi, a well-known poet in Chinese Song dynasty.

## Complex System with Flows and Synchronization

**Abstract:** A complex system  $\mathcal{S}$  consists of  $m$  components, maybe inconsistency with  $m \geq 2$  such as those of self-adaptive systems, particularly the biological systems and usually, a system with contradictions, i.e., there are no a classical mathematical subfield applicable. Then, *how can we hold its global and local behaviors or true face?* All of us know that there always exists universal connections between things in the world, i.e., a topological graph  $\vec{G}$  underlying parts in  $\mathcal{S}$ . We can thereby establish mathematics over a graph family  $\{\vec{G}_1, \vec{G}_2, \dots\}$  for characterizing the dynamic behaviors of system  $\mathcal{S}$  on the time  $t$ , i.e., *complex flows*. Formally, a complex flow  $\vec{G}^L$  is a topological graph  $\vec{G}$  associated with a mapping  $L : (v, u) \rightarrow L(v, u)$ , 2 end-operators  $A_{vu}^+ : L(v, u) \rightarrow L^{A_{vu}^+}(v, u)$  and  $A_{uv}^+ : L(u, v) \rightarrow L^{A_{uv}^+}(u, v)$  on a Banach space  $\mathcal{B}$  over a field  $\mathcal{F}$  with  $L(v, u) = -L(u, v)$  and  $A_{vu}^+(-L(v, u)) = -L^{A_{vu}^+}(v, u)$  for  $\forall (v, u) \in E(\vec{G})$  holding with continuity equations

$$\frac{dx_v}{dt} = \sum_{u \in N_G(v)} L^{A_{vu}^+}(v, u), \quad \forall v \in V(\vec{G}),$$

where  $x_v$  is a variable on vertex  $v$  for  $\forall v \in E(\vec{G})$ . Particularly, if  $dx_v/dt = \mathbf{0}$  for  $\forall v \in V(\vec{G})$ , such a complex flow  $\vec{G}^L$  is nothing else but an action flow or conservation flow. The main purpose of this lecture is to clarify the complex system with that of contradictory system and its importance to the reality of a thing T by extending Banach or Hilbert spaces to Banach or Hilbert continuity flow spaces over topological graphs  $\{\vec{G}_1, \vec{G}_2, \dots\}$  and establishing the global differential theory on complex flows, characterize the global dynamic behaviors of complex systems, particularly, complex networks independent on graphs, for instance the synchronization of complex systems by applying global differential on the complex flows  $\vec{G}^L$ .

**Key Words:** Complex system, Smarandache multispace, continuity flow, Banach space, Hilbert space, differential, Taylor formula, L'Hospital's rule, mathematical combinatorics.

**AMS(2010):** 34A26, 35A08, 46B25, 92B05, 05C10, 05C21, 34D43, 51D20.

### §1. Introduction

*Is our mathematical theory can already be used for understanding the reality of all things in the world?* This is a simple but essential question on the developing direction of mathematics, and its answer is not positive. All of us live in a world full of colors, encountering various phenomena such as those of gorgeous guppy or peacock shown in Fig.1 each day and cant help

---

<sup>1</sup>An invited J.C.& K.L.Saha Memorial Lecture in the *International Conference on Geometry and Mathematical Models in Complex Phenomena*, December 05-07, 2017.

<sup>2</sup>*Bull. Cal. Math. Soc.*, 109, (6) 461-484 (2017)

ourselves: *Why are they looks like this, not that, i.e., the reality of things in the macro and micro world*



**Fig.1**

For example, we all known or heard that birds flying in the sky and fishes swimming in the ocean from disorderly to orderly in the macro world, and also words that the superposition, i.e., a quantum particle is both in two or more possible states of being in the micro world. All of these show a beauty of the scenery in one's eyes. It should be noted that the superposition not only appeared in the micro world but also in the macro world. For example, there is a most reluctant to answer question for a Chinese man. That is, *if one's wife and his mother fell simultaneously in a river, who will he save first, his mother or his wife?* This Chinese question is also equivalent to the famous thought model of Schrödinger's cat, which assumed that a cat, a flask of poison and a radioactive source are placed in a sealed box. If an internal monitor detects radioactivity, the flask is shattered, releasing the poison which kills the cat. Yet, when one looks in the box, one sees the cat either alive or dead, but not both alive and dead. Then, Schrödinger asked: *Is the cat alive or dead?* Certainly, the two questions both show that the superposition can be also happen in the macro world.

Then, *what is the reality of a thing and where do the complex systems come from?* The word reality is the state of things as they actually exist, including everything that is and has been, whether or not it is observable or comprehensible. *Can one really hold on the reality of things?* Usually, a thing  $T$  is multilateral or complex, and so to hold on its reality is difficult for human beings, where the world *complex* implies the cognitive system on a thing  $T$  is complex, i.e., a system composes of many components which maybe interact with each other. A typical example for explaining the complex of cognitive system on a thing is the well-known fable "*the blind men with an elephant*".

In this fable, a group of blind men heard that a strange animal, called an elephant had been brought to the town but none of them were aware of its shape and form. "*We must inspect and know it by touch of which we are capable*". The first person hand landed on the trunk, said: "*this being is like a thick snake*". The 2nd one whose hand reached its ear, claimed it like a kind of fan. The 3rd person hand was upon its leg, said the elephant is a pillar like a tree-trunk. The 4th man hand upon its side said: "*the elephant is a wall*". The 5th felt its tail, described it as a rope and the last felt its tusk, stated the elephant is that being hard, smooth and like a spear. They then entered into an endless argument! "*All of you are right*" ! A wise

man explained to them: “*why are you telling it differently is because each one of you touched the different part of the elephant*”.



**Fig.2**

*What is the philosophical meaning of this fable to human beings?* It lies in that the situation of human beings hold on the reality of things is analogous to these blind men, i.e., a complex system. Usually, the reality of thing T identified with known characters on it at one time. For example, let  $\nu_i, i \geq 1$  be unknown and  $\mu_1, \mu_2, \dots, \mu_n$  known characters at time  $t$ . Then, the reality of thing T should be understood by

$$T = \left( \bigcup_{i=1}^n \{\mu_i\} \right) \cup \left( \bigcup_{k \geq 1} \{\nu_k\} \right), \quad (1.1)$$

i.e., a *Smarandache multispace* in logic with an approximation  $T^\circ = \bigcup_{i=1}^n \{\mu_i\}$  at time  $t$  ([22]), which also implies that the cognition on the reality of a thing T is only an approximation, and also the complex, i.e., the reality of a thing T is nothing else but a complex system.

Einstein once said the reality of things with that of mathematics: “*As far as the laws of mathematics refer to reality, they are not certain; and as far as they are certain, they do not refer to reality*”. *Why did Einstein say these words?* Because we have no a mathematical subfield applicable to complex system, i.e., the reality of thing T, and generally, we get a contradictory system in mathematics.

The main purpose of this lecture is applying the contradictory universality and the existence of universal connections between things T in the world, i.e., a topological graph  $\vec{G}$  underlying its parts in philosophy to establish a global mathematics over a graph family  $\{\vec{G}_1, \vec{G}_2, \dots\}$  for characterizing dynamic behaviors of a system on the time  $t$ , i.e., *complex flows* such as those of to extend Banach or Hilbert spaces to Banach or Hilbert continuity flow spaces over topological graphs  $\{\vec{G}_1, \vec{G}_2, \dots\}$  to establish the global differential theory on complex flows and how to characterize the global dynamic behaviors of complex systems by the global differential theory over graphs. These results can be also applied to complex networks and analyze their dynamic behaviors particularly, , for instance the synchronization of complex networks independent on graphs by applying global differential on the complex flows  $\vec{G}^L$ .

For terminologies and notations not mentioned here, we follow references [1] for mechanics, [4] for complex network, [5] for functional analysis, [7] for combinatorial geometry, [19] for biological mathematics, [21] for elementary particles, [6] and [30] for Smarandache systems and multispaces, and all phenomenons discussed in this paper are assumed to be true in the nature.

## §2. Contradictory Systems

The formula (1.1) implies that one's recognition on a thing  $T$  is usually non-completed, which is the origination of contradiction. In classical logic, a contradictory system consists of a logical incompatibility between two or more propositions, which is abandoned without discussion in classical mathematics because a mathematical system should be compatibility in logic. However, different things are contradictory in the eyes of human beings. This is the reason why classical mathematics can not provides a complete recognition on things  $T$ .

Usually, a physical phenomenon of a thing  $T$  is characterized by differential equations. If there is only one cell or one bird flying in the sky such as the flying bird, its dynamic behavior can be characterized easily by a orbit in the space, i.e., a differential equation

$$\dot{\bar{x}} = F(t, \bar{x}), \quad (2.1)$$



**Fig.3**

where,  $\dot{\bar{x}} = d\bar{x}/dt$ ,  $t$  is the time parameter and  $\bar{x}$  is the position of bird in  $\mathbb{R}^3$ . But *how can one characterize the behavior of a complex system of  $m$  cells with  $m \geq 2$  in Fig.3?* For example, a water molecule  $H_2O$  consists of 2 hydrogen atoms and 1 oxygen atom, and we have known the behavior of a particle is characterized by the Schrödinger equation

$$i\hbar \frac{\partial \psi}{\partial t} = -\frac{\hbar^2}{2m} \nabla^2 \psi + U\psi \quad (2.2)$$

in quantum mechanics ([21]).

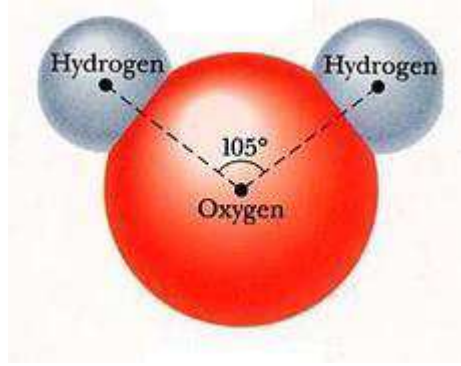

Fig.4

Can we conclude this equation is absolutely right for atoms  $H$  and  $O$  in water molecule  $H_2O$ ? Certainly not because equation (2.2) is always established with an additional assumption, i.e., the geometry on a particle  $P$  is a point in classical mechanics or a field in quantum mechanics.

In this case, if equation (2.2) is true for atoms  $H$  and  $O$ , we get three differential equations following

$$\begin{cases} -i\hbar \frac{\partial \psi_O}{\partial t} = \frac{\hbar^2}{2m_O} \nabla^2 \psi_O - V(x) \psi_O \\ -i\hbar \frac{\partial \psi_{H_1}}{\partial t} = \frac{\hbar^2}{2m_{H_1}} \nabla^2 \psi_{H_1} - V(x) \psi_{H_1} \\ -i\hbar \frac{\partial \psi_{H_2}}{\partial t} = \frac{\hbar^2}{2m_{H_2}} \nabla^2 \psi_{H_2} - V(x) \psi_{H_2} \end{cases} \quad (2.3)$$

on atoms  $H$  and  $O$ . Which is the right model on  $H_2O$ , the (2.2) or (2.3) dynamic equations? The answer is not so easy because the equation model (2.2) can only characterizes those of coherent behavior of atoms  $H$  and  $O$  in  $H_2O$ . Although equation (2.3) characterize the different behaviors of atoms  $H$  and  $O$  but it is non-solvable in mathematics ([14], [15]). Generally, when one wish to hold on the reality of a thing, i.e., a complex system, he usually get a contradictory system, which also implies that the mathematical known is not absolutely equal to the reality of a thing  $T$ . Thus, establish mathematics on non-mathematics, i.e., an envelope theory on mathematics for reality is needed ([11]).

Now, are these contradictory systems meaningless for human beings? The answer is not! For example, let  $T_1, T_2, T_3, T_4$  and  $T'_1, T'_2, T'_3, T'_4$  be respectively two groups of horses running constraint with

$$(LES_4^N) \begin{cases} x + y = 2 \\ x + y = -2 \\ x - y = -2 \\ x - y = 2 \end{cases} \quad (LES_4^S) \begin{cases} x = y \\ x + y = 4 \\ x = 2 \\ y = 2 \end{cases}$$

on the earth. It is clear that  $(LES_4^N)$  is non-solvable because  $x + y = -2$  is contradictory to  $x + y = 2$ , and so that for equations  $x - y = -2$  and  $x - y = 2$ . But system  $(LES_4^S)$  is solvable with  $x = 2$  and  $y = 2$ . Can we conclude that things  $T'_1, T'_2, T'_3, T'_4$  are  $x = 2, y = 2$  and  $T_1, T_2, T_3, T_4$  are nothing? Certainly not because all of them are horses running on the earth,



Fig.5

and their solvability only implies the orbits intersection in  $\mathbb{R}^2$  such as those shown in Fig.6.

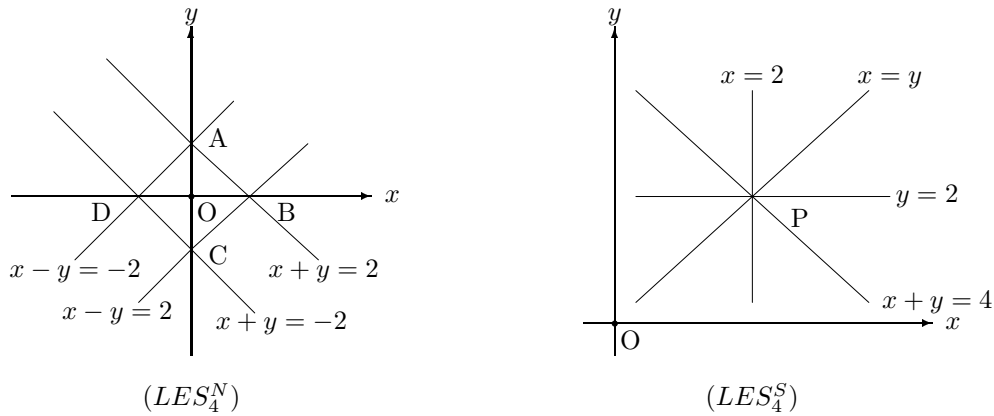

Fig.6

Denoted by  $L_{a,b,c} = \{(x, y) | ax + by = c, ab \neq 0\}$  be points in  $\mathbb{R}^2$ . We are easily know the behaviors of horses  $T_1, T_2, T_3, T_4$  and  $T'_1, T'_2, T'_3, T'_4$  are nothings else but the unions  $L_{1,-1,0} \cup L_{1,1,4} \cup L_{1,0,2} \cup L_{0,1,2}$  and  $L_{1,1,2} \cup L_{1,1,-2} \cup L_{1,-1,-2} \cup L_{1,-1,2}$ , i.e., Smarandache multispaces, respectively.

Generally, let  $\mathcal{F}_1, \mathcal{F}_2, \dots, \mathcal{F}_m$  be  $m$  mappings holding in conditions of the implicit mapping theorem and let  $S_{\mathcal{F}_i} \subset \mathbb{R}^n$  be a manifold such that  $\mathcal{F}_i : S_{\mathcal{F}_i} \rightarrow 0$  for integers  $1 \leq i \leq m$ . Consider the equations

$$\begin{cases} \mathcal{F}_1(x_1, x_2, \dots, x_n) = 0 \\ \mathcal{F}_2(x_1, x_2, \dots, x_n) = 0 \\ \dots\dots\dots \\ \mathcal{F}_m(x_1, x_2, \dots, x_n) = 0 \end{cases} \tag{2.4}$$

in Euclidean space  $\mathbb{R}^n, n \geq 1$ . Geometrically, the system (2.4) is non-solvable or not dependent on  $\bigcap_{i=1}^m S_{\mathcal{F}_i} = \emptyset$  or  $\neq \emptyset$ .



**Definition 2.1** A  $G$ -solution of system (2.4) is a labeling graph  $G^L$  defined by

$$V(G) = \{S_{\mathcal{F}_i}, 1 \leq i \leq n\};$$

$$E(G) = \{(S_{\mathcal{F}_i}, S_{\mathcal{F}_j}) \text{ if } S_{\mathcal{F}_i} \cap S_{\mathcal{F}_j} \neq \emptyset \text{ for integers } 1 \leq i, j \leq n\} \text{ with a labeling}$$

$$L: S_{\mathcal{F}_i} \rightarrow S_{\mathcal{F}_i}, \quad (S_{\mathcal{F}_i}, S_{\mathcal{F}_j}) \rightarrow S_{\mathcal{F}_i} \cap S_{\mathcal{F}_j}.$$

For example, the  $G$ -solutions of  $(LES_4^N)$  and  $(LES_4^S)$  are respectively labeling graphs  $C_4^L$  and  $K_4^L$  shown in Fig.7.

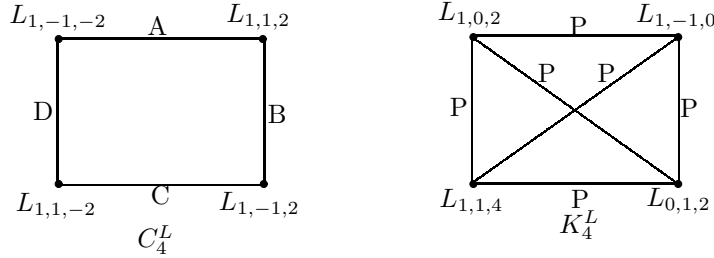
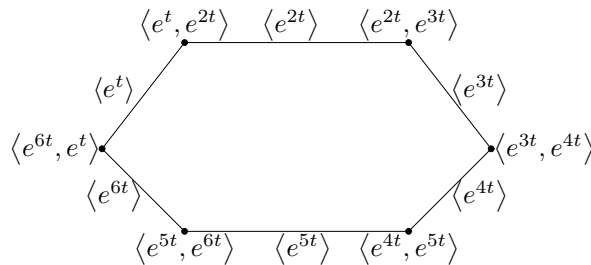

**Fig.7**

**Example 2.2** Let  $(LDES_6^1)$  be a system of linear homogeneous differential equations

$$\begin{cases} \ddot{x} - 3\dot{x} + 2x = 0 & (1) \\ \ddot{x} - 5\dot{x} + 6x = 0 & (2) \\ \ddot{x} - 7\dot{x} + 12x = 0 & (3) \\ \ddot{x} - 9\dot{x} + 20x = 0 & (4) \\ \ddot{x} - 11\dot{x} + 30x = 0 & (5) \\ \ddot{x} - 7\dot{x} + 6x = 0 & (6) \end{cases}$$

where  $\ddot{x} = \frac{d^2x}{dt^2}$  and  $\dot{x} = \frac{dx}{dt}$ . Clearly,  $(LDES_6^1)$  is a non-solvable system with solution bases  $\{e^t, e^{2t}\}$ ,  $\{e^{2t}, e^{3t}\}$ ,  $\{e^{3t}, e^{4t}\}$ ,  $\{e^{4t}, e^{5t}\}$ ,  $\{e^{5t}, e^{6t}\}$ ,  $\{e^{6t}, e^t\}$  respectively on equations (1) – (6) and  $G$ -solution shown in Fig.8,



**Fig.8**

where  $\langle \Delta \rangle$  denotes the linear space generalized by elements in  $\Delta$ .

A more interesting application of the  $G$ -solution is it can be applied to characterizing the global stability of differential equations (2.4), even it is non-solvable. See [8-12] for details.

### §3. Complex Flows

#### 3.1 Complex Flows

Holding on the reality of things, i.e., complex systems enables us to present an element called complex flow in mathematics on oriental philosophy, i.e., there always exist the universal contradiction and connection between things in the world. Then, *what is a complex flow? what is its role in understanding things in the world?*

**Definition 3.1** A continuity flow  $(\vec{G}; L, A)$  is an oriented embedded graph  $\vec{G}$  in a topological space  $\mathcal{S}$  associated with a mapping  $L : v \rightarrow L(v)$ ,  $(v, u) \rightarrow L(v, u)$ , 2 end-operators  $A_{vu}^+ : L(v, u) \rightarrow L^{A_{vu}^+}(v, u)$  and  $A_{uv}^+ : L(u, v) \rightarrow L^{A_{uv}^+}(u, v)$  on a Banach space  $\mathcal{B}$  over a field  $\mathcal{F}$

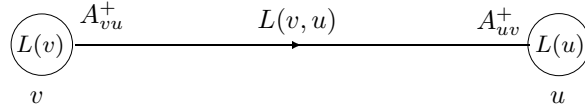

Fig.9

with  $L(v, u) = -L(u, v)$  and  $A_{vu}^+(-L(v, u)) = -L^{A_{vu}^+}(v, u)$  for  $\forall (v, u) \in E(\vec{G})$  holding with continuity equation

$$\sum_{u \in N_G(v)} L^{A_{vu}^+}(v, u) = L(v) \quad \text{for } \forall v \in V(\vec{G})$$

such as those shown for vertex  $v$  in Fig.10 following

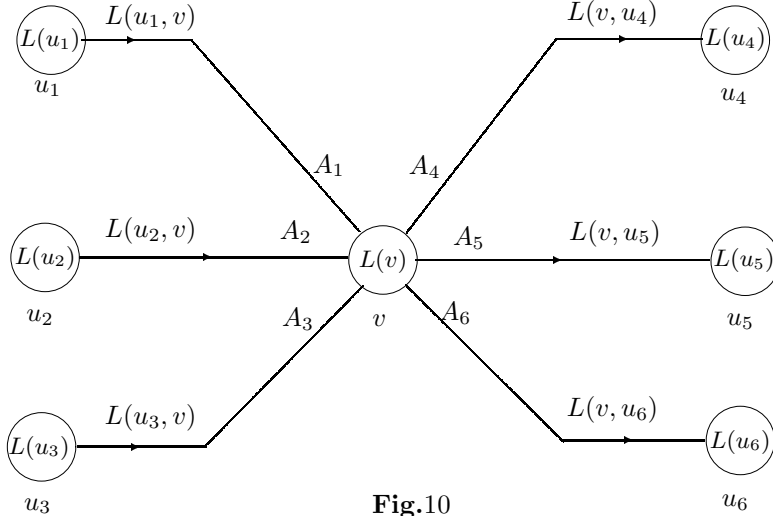

Fig.10

with a continuity equation

$$L^{A_1}(v, u_1) + L^{A_2}(v, u_2) + L^{A_3}(v, u_3) - L^{A_4}(v, u_4) - L^{A_5}(v, u_5) - L^{A_6}(v, u_6) = L(v),$$

where  $L(v)$  is the surplus flow on vertex  $v$ .

Particularly, we have known continuity flows following:

(1)  $L(v) = \dot{x}_v$ ,  $v \in V(\vec{G})$ . In this case,  $(\vec{G}; L, A)$  is said to be a *complex flow*, discussed in this lecture;

(2) For  $v \in V(\vec{G})$ ,  $x_v$  is a constant  $\mathbf{v}_v$  dependent on  $v$ . In this case,  $(\vec{G}; L, A)$  is said to be an *action flow*, which was discussed extensively in [16] with applications [14]-[15], [17] to elementary physics and biological systems;

(3)  $L(v) = \text{constant}$  independent on  $v$ ,  $v \in V(\vec{G})$ , which is a special case of action flow called  $A_0$   $\vec{G}$ -flow and shown can be applied to synchronization of system in this lecture;

(4) If  $A = \mathbf{1}_{\mathcal{V}}$ ,  $(\vec{G}; L, A)$  is said to be a  $\vec{G}$ -flow, which was discussed in [13];

(5) If  $A = \mathbf{1}_{\mathcal{V}}$  and  $\mathcal{V}$  is a number field  $\mathbb{Z}$  or  $\mathbb{R}$ ,  $(\vec{G}; L, A)$  is said to be a complex network, which was already discussed extensively in publications, for examples, [2]-[4] and [20].

For example, let the  $L : (v, u) \rightarrow L(v, u) \in \mathbb{R}^n \times \mathbb{R}^+$  with end-operators  $A_{vu}^+ = a_{vu} \frac{\partial}{\partial t}$  and  $a_{vu} : \mathbb{R}^n \rightarrow \mathbb{R}$  for any edge  $(v, u) \in E(\vec{G})$  in Fig.11 following.

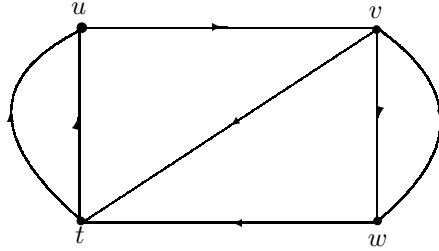

Fig.11

Then the conservation laws are partial differential equations

$$\begin{cases} a_{tu^1} \frac{\partial L(t, u)^1}{\partial t} + a_{tu^2} \frac{\partial L(t, u)^2}{\partial t} = a_{uv} \frac{\partial L(u, v)}{\partial t} \\ a_{uv} \frac{\partial L(u, v)}{\partial t} = a_{vw^1} \frac{\partial L(v, w)^1}{\partial t} + a_{vw^2} \frac{\partial L(v, w)^2}{\partial t} + a_{vt} \frac{\partial L(v, t)}{\partial t} \\ a_{vw^1} \frac{\partial L(v, w)^1}{\partial t} + a_{vw^2} \frac{\partial L(v, w)^2}{\partial t} = a_{wt} \frac{\partial L(w, t)}{\partial t} \\ a_{wt} \frac{\partial L(w, t)}{\partial t} + a_{vt} \frac{\partial L(v, t)}{\partial t} = a_{tu^1} \frac{\partial L(t, u)^1}{\partial t} + a_{tu^2} \frac{\partial L(t, u)^2}{\partial t} \end{cases}$$

which maybe solvable or not but characterize the behavior of things.

### 3.2 Extended Linear Space

Let  $\vec{\mathcal{G}}, \vec{G}_1, \vec{G}_2, \dots, \vec{G}_n$  be oriented graphs embedded in  $\mathcal{S}$  with  $\vec{\mathcal{G}} = \bigcup_{i=1}^n \vec{G}_i$ , i.e., each  $\vec{G}_i$  be a subgraph of  $\vec{\mathcal{G}}$  for integers  $1 \leq i \leq n$ . In this case, these is naturally an embedding  $\iota : \vec{G}_i \rightarrow \vec{\mathcal{G}}$ . Can we construct linear space by reviewing continuity flows  $\vec{G}_1^{L_1}, \vec{G}_2^{L_2}, \dots, \vec{G}_n^{L_n}$  not only labeling graphs but mathematical elements? The answer is yes!

Let  $\mathcal{V}$  be a linear space over a field  $\mathcal{F}$ . A vector labeling  $L : \vec{G} \rightarrow \mathcal{V}$  is a mapping with

$L(v), L(e) \in \mathcal{V}$  for  $\forall v \in V(\vec{G}), e \in E(\vec{G})$ . Define

$$\vec{G}_1^{L_1} + \vec{G}_2^{L_2} = \left(\vec{G}_1 \setminus \vec{G}_2\right)^{L_1} \cup \left(\vec{G}_1 \cap \vec{G}_2\right)^{L_1+L_2} \cup \left(\vec{G}_2 \setminus \vec{G}_1\right)^{L_2} \quad (3.1)$$

and

$$\lambda \cdot \vec{G}^L = \vec{G}^{\lambda \cdot L} \quad (3.2)$$

for  $\forall \lambda \in \mathcal{F}$ . Clearly, if  $\vec{G}^L, \vec{G}_1^{L_1}, \vec{G}_2^{L_2}$  are continuity flows with linear end-operators  $A_{vu}^+$  and  $A_{uv}^+$  for  $\forall(v, u) \in E(\vec{G})$ ,  $\vec{G}_1^{L_1} + \vec{G}_2^{L_2}$  and  $\lambda \cdot \vec{G}^L$  are continuity flows also. If we consider each continuity flow  $\vec{G}_i^{L_i}$  a continuity subflow of  $\vec{\mathcal{G}}^{\hat{L}}$ , where  $\hat{L} : \vec{G}_i = L(\vec{G}_i)$  but  $\hat{L} : \vec{\mathcal{G}} \setminus \vec{G}_i \rightarrow \mathbf{0}$  for integers  $1 \leq i \leq n$ , and define  $\mathbf{O} : \vec{\mathcal{G}} \rightarrow \mathbf{0}$ , then we get the following result.

**Theorem 3.1**([18]) *If  $A_{vu}^+$  and  $A_{uv}^+$  are linear end-operators for  $\forall(v, u) \in E(\vec{\mathcal{G}})$ , all continuity flows on oriented graphs  $\vec{G}_1, \vec{G}_2, \dots, \vec{G}_n$  naturally form a linear space, denoted by  $\left(\langle \vec{G}_i, 1 \leq i \leq n \rangle^{\mathcal{V}}; +, \cdot\right)$  over a field  $\mathcal{F}$  under operations (3.1) and (3.2).*

Particularly, for action flows, we get the following result.

**Theorem 3.2**([13], [16]) *Let  $\mathcal{G}$  be all action flows  $(\vec{G}; L, A)$  with linear end-operators  $A \in \mathbf{O}(\mathcal{V})$ . Then*

$$\dim \mathcal{G} = (\dim \mathbf{O}(\mathcal{V}) \times \dim \mathcal{V})^{\beta(\vec{G})}$$

if both  $\mathcal{V}$  and  $\mathbf{O}(\mathcal{V})$  are finite. Otherwise,  $\dim \mathcal{G}$  is infinite.

Particularly, if operators  $A \in \mathcal{V}^*$ , the dual space of  $\mathcal{V}$  on graph  $\vec{G}$ , then

$$\dim \mathcal{G} = (\dim \mathcal{V})^{2\beta(\vec{G})},$$

where  $\beta(\vec{G}) = \varepsilon(\vec{G}) - |\vec{G}| + 1$  is the Betti number of  $\vec{G}$ .

Notice that  $\vec{G}_1^{L_1} + \vec{G}_2^{L_2} \neq \vec{G}_1^{L_1}$  or  $\vec{G}_1^{L_1} + \vec{G}_2^{L_2} \neq \vec{G}_2^{L_2}$  if and only if  $\vec{G}_1 \not\subseteq \vec{G}_2$  with  $L_1 : \vec{G}_1 \setminus \vec{G}_2 \not\rightarrow \mathbf{0}$  or if  $\vec{G}_2 \not\subseteq \vec{G}_1$  with  $L_2 : \vec{G}_2 \setminus \vec{G}_1 \not\rightarrow \mathbf{0}$ , and generally, we say a continuity flow family  $\{\vec{G}_1^{L_1}, \vec{G}_2^{L_2}, \dots, \vec{G}_n^{L_n}\}$  is *linear irreducible* if for any integer  $i$ ,

$$\vec{G}_i \not\subseteq \bigcup_{l \neq i} \vec{G}_l \quad \text{with} \quad L_i : \vec{G}_i \setminus \bigcup_{l \neq i} \vec{G}_l \not\rightarrow \mathbf{0},$$

where  $1 \leq i \leq n$ . We know the following result on linear generated sets.

**Theorem 3.3**([18]) *Let  $\mathcal{V}$  be a linear space over a field  $\mathcal{F}$  and let  $\{\vec{G}_1^{L_1}, \vec{G}_2^{L_2}, \dots, \vec{G}_n^{L_n}\}$  be an linear irreducible family,  $L_i : \vec{G}_i \rightarrow \mathcal{V}$  for integers  $1 \leq i \leq n$  with linear operators  $A_{vu}^+$ ,  $A_{uv}^+$  for  $\forall(v, u) \in E(\vec{G})$ . Then,  $\{\vec{G}_1^{L_1}, \vec{G}_2^{L_2}, \dots, \vec{G}_n^{L_n}\}$  is an independent generated set of*

$\langle \vec{G}_i, 1 \leq i \leq n \rangle^{\mathcal{V}}$ , called basis, i.e.,

$$\dim \langle \vec{G}_i, 1 \leq i \leq n \rangle^{\mathcal{V}} = n.$$

### 3.3 Extended Commutative Rings

Furthermore, if  $\mathcal{V}$  is a commutative ring  $(\mathcal{R}; +, \cdot)$ , can we extend it over oriented graph family  $\{\vec{G}_1, \vec{G}_2, \dots, \vec{G}_n\}$  by introducing operation “+” with (3.1) and operation “ $\cdot$ ” following:

$$\vec{G}_1^{L_1} \cdot \vec{G}_2^{L_2} = \left( \vec{G}_1 \setminus \vec{G}_2 \right)^{L_1} \cup \left( \vec{G}_1 \cap \vec{G}_2 \right)^{L_1 \cdot L_2} \cup \left( \vec{G}_2 \setminus \vec{G}_1 \right)^{L_2},$$

where  $L_1 \cdot L_2 : x \rightarrow L_1(x) \cdot L_2(x)$ ? The answer is yes! We get the following result:

**Theorem 3.4**([18]) *Let  $(\mathcal{R}; +, \cdot)$  be a commutative ring and let  $\{\vec{G}_1^{L_1}, \vec{G}_2^{L_2}, \dots, \vec{G}_n^{L_n}\}$  be a linear irreducible family,  $L_i : \vec{G}_i \rightarrow \mathcal{R}$  for integers  $1 \leq i \leq n$  with linear operators  $A_{vu}^+, A_{uv}^+$  for  $\forall (v, u) \in E(\vec{G})$ . Then,  $\left( \langle \vec{G}_i, 1 \leq i \leq n \rangle^{\mathcal{R}}; +, \cdot \right)$  is a commutative ring.*

### 3.4 Banach or Hilbert Space

We have shown that  $\vec{G}^{\mathcal{V}}$  is a Banach space, and furthermore, Hilbert space if  $\mathcal{V}$  is a Banach or Hilbert space for an oriented graph  $\vec{G}$  embedded in topological space  $\mathcal{S}$  in [13] and [16]. Generally, let  $\{\vec{G}_1^{L_1}, \vec{G}_2^{L_2}, \dots, \vec{G}_n^{L_n}\}$  be a basis of  $\langle \vec{G}_i, 1 \leq i \leq n \rangle^{\mathcal{V}}$ , where  $\mathcal{V}$  is a Banach space with a norm  $\|\cdot\|$ . Can we extend Banach space  $V$  over  $\langle \vec{G}_i, 1 \leq i \leq n \rangle$ ? And similarly, can we extend Hilbert space  $V$  over  $\langle \vec{G}_i, 1 \leq i \leq n \rangle$ ? The answer is yes!

For  $\forall \vec{G}^L \in \langle \vec{G}_i, 1 \leq i \leq n \rangle^{\mathcal{V}}$ , define

$$\|\vec{G}^L\| = \sum_{e \in E(\vec{G})} \|L(e)\|$$

or

$$\begin{aligned} \langle \vec{G}_1^{L_1}, \vec{G}_2^{L_2} \rangle &= \sum_{e \in E(\vec{G}_1 \setminus \vec{G}_2)} \langle L_1(e), L_1(e) \rangle \\ &+ \sum_{e \in E(\vec{G}_1 \cap \vec{G}_2)} \langle L_1(e), L_2(e) \rangle + \sum_{e \in E(\vec{G}_2 \setminus \vec{G}_1)} \langle L_2(e), L_2(e) \rangle. \end{aligned} \quad (2.10)$$

Then we are easily know also that

**Theorem 3.5**([18]) *Let  $\vec{G}_1, \vec{G}_2, \dots, \vec{G}_n$  be oriented graphs embedded in a space  $\mathcal{S}$  and  $\mathcal{V}$  a Banach space over a field  $\mathcal{F}$ . Then  $\langle \vec{G}_i, 1 \leq i \leq n \rangle^{\mathcal{V}}$  with linear operators  $A_{vu}^+, A_{uv}^+$  for  $\forall (v, u) \in E(\vec{G})$  is a Banach space, and furthermore, if  $\mathcal{V}$  is a Hilbert space,  $\langle \vec{G}_i, 1 \leq i \leq n \rangle^{\mathcal{V}}$*

is a Hilbert space too.

Therefore, we can consider calculus and differentials on Hilbert space  $\langle \vec{G}_i, 1 \leq i \leq n \rangle^\mathcal{V}$ .  
Now, if  $L$  is  $k$ th differentiable to  $t$  on a domain  $\mathcal{D} \subset \mathbb{R}$ , where  $k \geq 1$  and we define

$$\frac{d\vec{G}^L}{dt} = \vec{G} \frac{dL}{dt} \quad \text{and} \quad \int_0^t \vec{G}^L dt = \vec{G}_0^{\int_0^t L dt}.$$

Then, *what will happens?* We can generalize Taylor formula on differentiable functions in  $\langle \vec{G}_i, 1 \leq i \leq n \rangle^\mathcal{V}$  following.

**Theorem 3.6(Taylor)([18])** Let  $\vec{G}^L \in \langle \vec{G}_i, 1 \leq i \leq n \rangle^{\mathbb{R} \times \mathbb{R}^n}$  and there exist  $k$ th order derivative of  $L$  to  $t$  on a domain  $\mathcal{D} \subset \mathbb{R}$ , where  $k \geq 1$ . If  $A_{vu}^+$ ,  $A_{uv}^+$  are linear for  $\forall (v, u) \in E(\vec{G})$ , then

$$\vec{G}^L = \vec{G}^{L(t_0)} + \frac{t-t_0}{1!} \vec{G}^{L'(t_0)} + \dots + \frac{(t-t_0)^k}{k!} \vec{G}^{L^{(k)}(t_0)} + o\left((t-t_0)^{-k} \vec{G}\right),$$

for  $\forall t_0 \in \mathcal{D}$ , where  $o\left((t-t_0)^{-k} \vec{G}\right)$  denotes such an infinitesimal term  $\widehat{L}$  of  $L$  that

$$\lim_{t \rightarrow t_0} \frac{\widehat{L}(v, u)}{(t-t_0)^k} = 0 \quad \text{for} \quad \forall (v, u) \in E(\vec{G}).$$

Particularly, if  $L(v, u) = f(t)c_{vu}$ , where  $c_{vu}$  is a constant, denoted by  $f(t)\vec{G}^{L_C}$  with  $L_C : (v, u) \rightarrow c_{vu}$  for  $\forall (v, u) \in E(\vec{G})$  and

$$f(t) = f(t_0) + \frac{(t-t_0)}{1!} f'(t_0) + \frac{(t-t_0)^2}{2!} f''(t_0) + \dots + \frac{(t-t_0)^k}{k!} f^{(k)}(t_0) + o\left((t-t_0)^k\right),$$

then

$$f(t)\vec{G}^{L_C} = f(t) \cdot \vec{G}^{L_C}.$$

This formula for continuity flow  $\vec{G}^L$  enables one to find interesting results and formulas on  $\vec{G}^L$  by  $f(t\vec{G})$  such as those of the following.

**Corollary 3.7** Let  $f(t)$  be a  $k$  differentiable function to  $t$  on a domain  $\mathcal{D} \subset \mathbb{R}$  with  $0 \in \mathcal{D}$  and  $f(0\vec{G}) = f(0)\vec{G}$ . If  $A_{vu}^+$ ,  $A_{uv}^+$  are linear for  $\forall (v, u) \in E(\vec{G})$ , then

$$f(t)\vec{G} = f(t\vec{G}).$$

For examples,

$$e^{t\vec{G}} = e^t \vec{G} = \vec{G} + \frac{t}{1!} \vec{G} + \frac{t^2}{2!} \vec{G} + \dots + \frac{t^k}{k!} \vec{G} + \dots$$

and for a real number  $\alpha$  if  $|t| < 1$ ,

$$\left(\vec{G} + t\vec{G}\right)^\alpha = \vec{G} + \frac{\alpha t}{1!}\vec{G} + \dots + \frac{\alpha(\alpha-1)\dots(\alpha-n+1)t^n}{n!}\vec{G} + \dots$$

#### §4. Synchronization Independent on Graphs

How can we characterize the behavior of a self-adaptive system with cells  $m \geq 2$ , for instance a flock of  $m$  birds? A natural way for characterizing the behavior of  $m$  birds is to collect all dynamic equations of cells, i.e.,

$$\begin{cases} \dot{\bar{x}}_1 = F_1(t, \bar{x}_1) \\ \dot{\bar{x}}_2 = F_2(t, \bar{x}_2) \\ \dots\dots\dots \\ \dot{\bar{x}}_m = F_m(t, \bar{x}_m) \end{cases} \quad (4.1)$$

to characterize the global behavior of the system.

However, birds or generally, cells in a self-adaptive system are interacted each other. The system (1.2) only is a collection of equation of each cell, not a global characterizing of the biological system in space. Including the interaction of cells enables one to apply  $m$  geometrical points in  $\mathbb{R}^3$  and characterizing the system by a system of differential equations following

$$\begin{cases} \dot{\bar{x}}_1 = F_1(t, \bar{x}_1) + \sum_{j \neq 1} H_j(\bar{x}_j \rightarrow \bar{x}_1) \\ \dot{\bar{x}}_2 = F_2(t, \bar{x}_2) + \sum_{j \neq 2} H_j(\bar{x}_j \rightarrow \bar{x}_2) \\ \dots\dots\dots \\ \dot{\bar{x}}_m = F_m(t, \bar{x}_m) + \sum_{j \neq m} H_j(\bar{x}_j \rightarrow \bar{x}_m) \end{cases}, \quad (4.2)$$

where  $F_i : \mathbb{R}^3 \rightarrow \mathbb{R}^3$  is generally a nonlinear function characterizing the external appearance of  $i$ th cell and  $H_j(x_j \rightarrow x_i)$  is the action strength of the  $j$ th cell to the  $i$ th cell in this system for integers  $1 \leq i, j \leq m$ .

Then, *what is the synchronization of a self-adaptive system?* The synchronization characterizes the behavior of a self-adaptive system from disorderly to orderly, such as those of birds flock or fishes shoal. By system (4.2) of differential equations, the synchronization nature is formally defined following.

**Definition 4.1**([4]) *The system (4.2) is said to be complete synchronization if*

$$\lim_{t \rightarrow \infty} \|\bar{x}_i(t) - \bar{x}_j(t)\| = 0$$

for all integers  $i, j = 1, 2, \dots, m$ , where  $\|\cdot\|$  is the Euclidean norm.

In the past decades, many researchers discussed the synchronization of (4.2) in case of





as those shown in Fig.12.

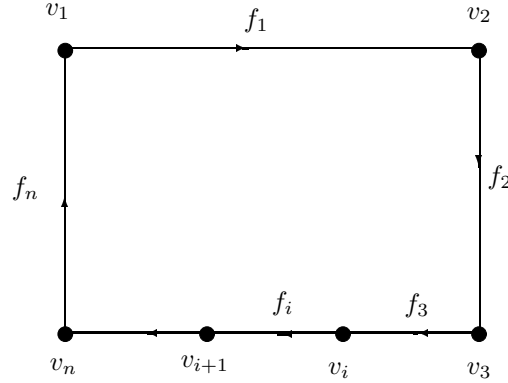

**Fig.12**

We are easily know that

$$f_1 - f_n = f_2 - f_1 = f_3 - f_2 = \cdots = f_{i+1} - f_i = \cdots = f_n - f_{n-1}$$

by the definition of  $A_0$ -flow, which only have solutions  $f_1 = f_2 = \cdots = f_n$ . Thus, it is a zero  $A_0$  flows.

Similarly, if there is an  $A_0$   $\vec{G}$ -flow on  $\vec{P}_n$  such as those shown in Fig.13.

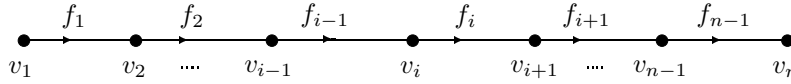

**Fig.13**

We are easily know that

$$-f_1 = f_2 - f_1 = \cdots = f_i - f_{i-1} = \cdots = f_{n-1} - f_{n-2} = f_{n-1}$$

by the definition of  $A_0$  flow, which only have solutions  $f_1 = f_2 = \cdots = f_n = \mathbf{0}$ . Thus, it is a zero  $A_0$  flows also.

A complex  $A_0$  flow  $\vec{G}^L$  exists in  $\langle \vec{G}_i, 1 \leq i \leq n \rangle^{\mathbb{R} \times \mathbb{R}^n}$  if and only if  $L(v) = F(t, \bar{x})$  for  $\forall v \in V(\vec{G})$ , where  $F(t, \bar{x})$  is independent on the interaction in  $\vec{G}^L$ . i.e., the system of continuity equations

$$\sum_{u \in N_G(v)} L^{A_{vu}^+}(v, u) = F(t, \bar{x}), \quad \forall v \in V(\vec{G}) \quad (4.4)$$

with the same solvable differential equation

$$\frac{dx_v}{dt} = F(t, \bar{x})$$

characterizing the behavior of variables on  $v \in V(\vec{G})$ , which is homogenous. Thus, we know

the following result by definition.

**Theorem 4.3** A complex  $A_0$  flow  $\vec{G}^L$  exists in Hilbert space  $\langle \vec{G}_i, 1 \leq i \leq n \rangle^{\mathbb{R} \times \mathbb{R}^n}$  if and only if the ordinary differential equation

$$\frac{dx}{dt} = F(t, x) \quad (4.5)$$

is solvable in Hilbert space  $\langle \vec{G}_i, 1 \leq i \leq n \rangle^{\mathbb{R} \times \mathbb{R}^n}$ .

Such a solution is usually called a multispace solution of (4.5).

**Definition 4.4** Let  $\vec{G}^L, \vec{G}_1^{L_1} \in \langle \vec{G}_i, 1 \leq i \leq n \rangle^{\mathcal{Y}}$  with  $L, L_1$  dependent on a variable  $t \in [a, b] \subset (-\infty, +\infty)$  and linear continuous end-operators  $A_{vu}^+$  for  $\forall (v, u) \in E(\vec{G})$ . For  $t_0 \in [a, b]$  and any number  $\varepsilon > 0$ , if there is always a number  $\delta(\varepsilon)$  such that if  $|t - t_0| \leq \delta(\varepsilon)$  then  $\|\vec{G}_1^{L_1} - \vec{G}^L\| < \varepsilon$ , then,  $\vec{G}_1^{L_1}$  is said to be converged to  $\vec{G}^L$  as  $t \rightarrow t_0$ , denoted by  $\lim_{t \rightarrow t_0} \vec{G}_1^{L_1} = \vec{G}^L$ . Particularly, if  $\vec{G}^L$  is a continuity flow with a constant  $L(v)$  for  $\forall v \in V(\vec{G})$  and  $t_0 = +\infty$ ,  $\vec{G}_1^{L_1}$  is said to be  $\vec{G}$ -synchronized.

These is a well-known result on liner operators following, which is useful to determining the synchronization of systems.

**Theorem 4.5**([5]) Let  $\mathcal{B}_1, \mathcal{B}_2$  be Banach spaces over a field  $\mathbb{F}$  with norms  $\|\cdot\|_1$  and  $\|\cdot\|_2$ , respectively. Then, a linear operator  $\mathbf{T} : \mathcal{B}_1 \rightarrow \mathcal{B}_2$  is continuous if and only if it is bounded, or equivalently,

$$\|\mathbf{T}\| := \sup_{\mathbf{0} \neq \mathbf{v} \in \mathcal{B}_1} \frac{\|\mathbf{T}(\mathbf{v})\|_2}{\|\mathbf{v}\|_1} < +\infty.$$

According to Theorem 4.5, if  $A_{vu}^+$  is liner continuous operator there must be a constant  $c_{vu}$  such that  $\|A_{vu}^+\| \leq c_{vu}$  for  $\forall (v, u) \in E(\vec{G})$ . Let

$$c_{G_1 G}^{\max} = \left\{ \max_{(v, u) \in E(G_1)} c_{vu}^+, \max_{(v, u) \in E(G_1)} c_{vu}^+ \right\}.$$

Then, we get an equivalent condition for  $\lim_{t \rightarrow t_0} \vec{G}_1^{L_1} = \vec{G}^L$  following.

**Theorem 4.6**  $\lim_{t \rightarrow t_0} \vec{G}_1^{L_1} = \vec{G}^L$  if and only if for any number  $\varepsilon > 0$  there is always a number  $\delta(\varepsilon)$  such that if  $|t - t_0| \leq \delta(\varepsilon)$  then  $\|L_1(v, u)\| < \varepsilon$  for  $(v, u) \in E(\vec{G}_1 \setminus \vec{G})$ ,  $\|(L_1 - L)(v, u)\| < \varepsilon$  for  $(v, u) \in E(\vec{G}_1 \cap \vec{G})$  and  $\|-L(v, u)\| < \varepsilon$  for  $(v, u) \in E(\vec{G} \setminus \vec{G}_1)$ , i.e.,  $\vec{G}_1^{L_1} - \vec{G}^L$  is an infinitesimal or  $\lim_{t \rightarrow t_0} (\vec{G}_1^{L_1} - \vec{G}^L) = \mathbf{O}$ .

*Proof* Clearly,

$$\begin{aligned}
& \left\| \vec{G}_1^{L_1} - \vec{G}^L \right\| \\
&= \left\| (\vec{G}_1 \setminus \vec{G})^{L_1} \right\| + \left\| (\vec{G}_1 \cap \vec{G})^{L_1 - L} \right\| + \left\| (\vec{G} \setminus \vec{G}_1)^{-L} \right\| \\
&= \sum_{u \in N_{G_1 \setminus G}(v)} \left\| L_1^{A'_{vu}+}(v, u) \right\| + \sum_{u \in N_{G_1 \cap G}(v)} \left\| \left( L_1^{A'_{vu}+} - L_{vu}^{A'_{vu}+} \right) (v, u) \right\| + \sum_{u \in N_{G \setminus G_1}(v)} \left\| -L^{A'_{vu}+}(v, u) \right\| \\
&\leq \sum_{u \in N_{G_1 \setminus G}(v)} c_{vu}^+ \|L_1(v, u)\| + \sum_{u \in N_{G_1 \cap G}(v)} c_{vu}^+ \|(L_1 - L)(v, u)\| + \sum_{u \in N_{G \setminus G_1}(v)} c_{vu}^+ \|-L(v, u)\|
\end{aligned}$$

and  $\|L(v, u)\| \geq 0$  for  $(v, u) \in E(\vec{G})$  and  $E(\vec{G}_1)$ . If  $\left\| \vec{G}_1^{L_1} - \vec{G}^L \right\| < \varepsilon$ , we are easily knowing that  $\|L_1(v, u)\| < c_{G_1 G}^{\max} \varepsilon$  for  $(v, u) \in E(\vec{G}_1 \setminus \vec{G})$ ,  $\|(L_1 - L)(v, u)\| < c_{G_1 G}^{\max} \varepsilon$  for  $(v, u) \in E(\vec{G}_1 \cap \vec{G})$  and  $\|-L(v, u)\| < c_{G_1 G}^{\max} \varepsilon$  for  $(v, u) \in E(\vec{G} \setminus \vec{G}_1)$ .

Conversely, if  $\|L_1(v, u)\| < \varepsilon$  for  $(v, u) \in E(\vec{G}_1 \setminus \vec{G})$ ,  $\|(L_1 - L)(v, u)\| < \varepsilon$  for  $(v, u) \in E(\vec{G}_1 \cap \vec{G})$  and  $\|-L(v, u)\| < \varepsilon$  for  $(v, u) \in E(\vec{G} \setminus \vec{G}_1)$ , we easily find that

$$\begin{aligned}
\left\| \vec{G}_1^{L_1} - \vec{G}^L \right\| &= \sum_{u \in N_{G_1 \setminus G}(v)} \left\| L_1^{A'_{vu}+}(v, u) \right\| + \sum_{u \in N_{G_1 \cap G}(v)} \left\| \left( L_1^{A'_{vu}+} - L_{vu}^{A'_{vu}+} \right) (v, u) \right\| \\
&+ \sum_{u \in N_{G \setminus G_1}(v)} \left\| -L^{A'_{vu}+}(v, u) \right\| \\
&\leq \sum_{u \in N_{G_1 \setminus G}(v)} c_{vu}^+ \|L_1(v, u)\| + \sum_{u \in N_{G_1 \cap G}(v)} c_{vu}^+ \|(L_1 - L)(v, u)\| \\
&+ \sum_{u \in N_{G \setminus G_1}(v)} c_{vu}^+ \|-L(v, u)\| \\
&< \left| \vec{G}_1 \setminus \vec{G} \right| c_{G_1 G}^{\max} \varepsilon + \left| \vec{G}_1 \cap \vec{G} \right| c_{G_1 G}^{\max} \varepsilon + \left| \vec{G} \setminus \vec{G}_1 \right| c_{G_1 G}^{\max} \varepsilon = \left| \vec{G}_1 \cup \vec{G} \right| c_{G_1 G}^{\max} \varepsilon.
\end{aligned}$$

This completes the proof.  $\square$

An application of Theorem 4.6 enables us to get a result on synchronization of complex flows following, which is independent on the underlying structure of cells of a self-adaptive system.

**Theorem 4.7** *A complex flow  $\vec{G}^L$  with linear continuous end-operator  $A_{vu}^+$  for  $\forall (v, u) \in E(\vec{G})$  is  $\vec{G}$ -synchronized if and only if for any number  $\varepsilon > 0$  if  $t \geq N(\varepsilon)$  then  $\|L(v) - L(u)\| < \varepsilon$  for  $\forall v, u \in V(\vec{G})$ , i.e., flows on vertex are synchronized.*

*Proof* By definition, if  $\vec{G}^L$  is synchronized, there must be a non-zero  $A_0$  flow  $\vec{G}_0^{L_0}$  and a number  $N(\varepsilon)$  such that  $\left\| \vec{G}^L - \vec{G}_0^{L_0} \right\| < \varepsilon$  if  $t \geq N(\varepsilon)$ , which implies that  $\|L(v, u)\| < \varepsilon$  for  $u \in V(\vec{G} \setminus \vec{G}_0)$ ,  $\|(L - L_0)(v, u)\| < \varepsilon$  for  $u \in V(\vec{G} \cap \vec{G}_0)$  and  $\|-L_0(v, u)\| < \varepsilon$  for  $u \in V(\vec{G}_0 \setminus \vec{G})$  by Theorem 4.6.

Therefore,

$$\|L(v)\| = \sum_{u \in N_G(v)} \|L^{A_{vu}^+}(v, u)\| \leq \sum_{u \in N_G(v)} c_{vu}^+ \|L(v, u)\| \leq |N_G(v)| c_{GG_0}^{\max} \varepsilon$$

for  $\forall v \in V(\vec{G})$  by applying Theorem 4.6. Thus,

$$\|L(v) - L(u)\| \leq \|L(v)\| + \|L(u)\| \leq (|N_G(v)| + |N_G(u)|) c_{GG_0}^{\max} \varepsilon < \varepsilon$$

for  $\forall v, u \in V(\vec{G})$  if  $t \geq N\left(\frac{\varepsilon}{c_{GG_0}^{\max} (|N_G(v)| + |N_G(u)|)}\right)$ .

Conversely, if there is a number  $\varepsilon > 0$  such that  $\|L(v) - L(u)\| < \varepsilon$  if  $t \geq N(\varepsilon)$  for  $\forall v, u \in V(\vec{G})$ , we are easily know that  $\lim_{t \rightarrow \infty} L(v) = \lim_{t \rightarrow \infty} L(u) = \mathbf{v}$  for  $\forall v, u \in V(\vec{G})$ . Let  $\lim_{t \rightarrow \infty} \vec{G}^L = \vec{G}^{L_0}$ . Then,  $\vec{G}^{L_0}$  is a non-zero  $A_0$  flow by definition and follows that

$$\begin{aligned} \|\vec{G}^L - \vec{G}^{L_0}\| &= \sum_{u \in N_G(v)} \|L^{A_{vu}^+}(v, u)\| \\ &\leq \sum_{(v,u) \in E(\vec{G})} c_G^{\max} \|(L - L_0)(v, u)\| \\ &= \frac{1}{2} \sum_{v \in V(\vec{G})} c_G^{\max} \|(L - L_0)(v)\| \leq |\vec{G}| c_G^{\max} \varepsilon < \varepsilon \end{aligned}$$

if  $t \geq N\left(\frac{\varepsilon}{c_G^{\max} |\vec{G}|}\right)$ , i.e., an infinitesimal which completes the proof.  $\square$

Denoted by  $\vec{\Delta} = \vec{G}_1^{L_1} - \vec{G}^L$  in Definition 4.1. Then,  $\vec{\Delta}$  is an infinitesimal by Theorem 4.5, denoted by  $o(t\vec{G})$ . We therefore know a conclusion following by Theorem 4.7, which completely changed the notion that synchronization dependent on the structure of  $\vec{G}$ .

**Theorem 4.8** *A continuity flow  $\vec{G}^L$  with liner continuous end-operator  $A_{vu}^+$  for  $\forall (v, u) \in E(\vec{G})$  is  $\vec{G}$ -synchronized if and only if there is a non-zero  $A_0$  flow  $\vec{G}_0^{L_0}$  such that*

$$\vec{G}^L = \vec{G}_0^{L_0} + o(t^{-1}\vec{G}),$$

*independent on the structure of  $\vec{G}$ .*

Notice that

$$\frac{d}{dt} \left( \sum_{u \in N_G(v)} L^{A_{vu}^+}(v, u) \right) = \sum_{u \in N_G(v)} \frac{d}{dt} L^{A_{vu}^+}(v, u)$$

for  $\forall v \in V(\vec{G})$  and  $\frac{d \ln |t|}{dt} = t^{-1}$ . We get the following result on a synchronized complex flow.

**Theorem 4.9** A complex flow  $\vec{G}^L$  with linear continuous end-operators  $A_{vu}^+$  for  $\forall(v, u) \in E(\vec{G})$  is  $\vec{G}$ -synchronized if and only if there is a non-zero  $A_0$  flow  $\vec{G}^{L_0}$  such that

$$\vec{G}^L = \vec{G}^{L_0} + o\left(\ln |t| \vec{G}\right).$$

Particularly, if each  $A_{vu}^+$  is a constant for  $\forall(v, u) \in E(\vec{G})$ , we get the conclusion following.

**Corollary 4.10** A complex flow  $\vec{G}^L$  with  $A_{vu}^+ = c_{vu}$ , a constant for  $\forall(v, u) \in E(\vec{G})$  is synchronized if and only if there is a non-zero  $A_0$  flow  $\vec{G}^{L_0}$  such that

$$\vec{G}^L = \vec{G}^{L_0} + o\left(\ln |t| \vec{G}\right).$$

For example, let  $A_{v_i v_{i+1}}^+ = 1$ ,  $A_{v_i v_{i-1}}^+ = 2$  and

$$f_i = \frac{f_1 + (2^{i-1} - 1) F(t, \bar{x})}{2^{i-1}}$$

for integers  $1 \leq i \leq n$  in Fig.12. We have known  $\vec{C}_n^f$  with  $f: (v_i, v_{i+1}) \rightarrow f_i$  is a non-zero  $A_0$  flow. Construct a complex flow  $\vec{C}_n^L$  by letting

$$L: (v_i, v_{i+1}) \rightarrow \frac{f_1 + (2^{i-1} - 1) F(t, \bar{x})}{2^{i-1}} + \frac{n!}{t^i}$$

and

$$L_\Delta: (v_i, v_{i+1}) \rightarrow \frac{n!}{t^i}.$$

Notice that  $\vec{C}_n^{L_\Delta} = o\left(t^{-1} \vec{C}_n\right)$ . We therefore known that the complex flow  $\vec{C}_n^L$  is  $\vec{G}$ -synchronized by Corollary 4.10. However, by the master stability functions in [20] we can only conclude that it is difficult to attain the synchronization for  $\vec{C}_n, n \geq 3$ .

## §5. Conclusion

The reality of a thing  $T$  is essentially a complex system, even a contradictory system in the eyes of human beings, and there are no a mathematical subfield applicable until today. Thus, a new mathematical theory should be established for holding on the reality of things in the world. For this objective, the *mathematical combinatorics*, i.e., mathematics over graphs and particularly, the mathematics on complex flows  $\vec{G}^L$  is a candidate because every thing  $T$  is not isolated but connected with other things in the world, and a complex system or a contradictory system in classical is nothing else but a mathematics over a graph  $\vec{G}$ .

## References

- [1] R.Abraham and J.E.Marsden, *Foundation of Mechanics* (2nd edition), Addison-Wesley, Reading, Mass, 1978.

- [2] R.Albert and A.L.Barabaši, Topology of evolving networks: local events and universality, *Physical Review E*, Vol.85(24)(2000), 5234-5240.
- [3] A.L.Barabaši and R. Albert, Emergence of scaling in random network, *Science*, Vol.286 (5439) (1999),509-520.
- [4] G.R.Chen, X.F.Wang and X.Li, *Introduction to Complex Networks – Models, Structures and Dynamics* (2 Edition), Higher Education Press, Beijing, 2015.
- [5] John B.Conway, *A Course in Functional Analysis*, Springer-Verlag New York,Inc., 1990.
- [6] Linfan Mao, *Smarandache Multi-Space Theory*, The Education Publisher Inc., USA, 2011.
- [7] Linfan Mao, *Combinatorial Geometry with Applications to Field Theory*, The Education Publisher Inc., USA, 2011.
- [8] Linfan Mao, Global stability of non-solvable ordinary differential equations with applications, *International J.Math. Combin.*, Vol.1 (2013), 1-37.
- [9] Linfan Mao, Non-solvable equation systems with graphs embedded in  $\mathbf{R}^n$ , *Proceedings of the First International Conference on Smarandache Multispace and Multistructure*, The Education Publisher Inc. July, 2013.
- [10] Linfan Mao, Geometry on  $G^L$ -systems of homogenous polynomials, *International J.Contemp. Math. Sciences*, Vol.9 (2014), No.6, 287-308.
- [11] Linfan Mao, Mathematics on non-mathematics - A combinatorial contribution, *International J.Math. Combin.*, Vol.3(2014), 1-34.
- [12] Linfan Mao, Cauchy problem on non-solvable system of first order partial differential equations with applications, *Methods and Applications of Analysis*, Vol.22, 2(2015), 171-200.
- [13] Linfan Mao, Extended Banach  $\vec{G}$ -flow spaces on differential equations with applications, *Electronic J.Mathematical Analysis and Applications*, Vol.3, No.2 (2015), 59-91.
- [14] Linfan Mao, A new understanding of particles by  $\vec{G}$ -flow interpretation of differential equation, *Progress in Physics*, Vol.11(2015), 193-201.
- [15] Linfan Mao, A review on natural reality with physical equation, *Progress in Physics*, Vol.11(2015), 276-282.
- [16] Linfan Mao, Mathematics with natural reality–action flows, *Bull.Cal.Math.Soc.*, Vol.107, 6(2015), 443-474.
- [17] Linfan Mao, Biological  $n$ -system with global stability, *Bull.Cal.Math.Soc.*, Vol.108, 6(2016), 403-430.
- [18] Linfan Mao, Hilbert flow spaces with operators over topological graphs, *International J.Math. Combin.*, Vol.4(2017), 19-45.
- [19] J.D.Murray, *Mathematical Biology I: An Introduction* (3rd Edition), Springer-Verlag Berlin Heidelberg, 2002.
- [20] L.M.Pecora and T.L. Carrol, Master stability functions for synchronized coupled systems, *Physical Review Letters*, 80(1998), 2109-2112.
- [21] Quang Ho-Kim and Pham Xuan Yem, *Elementary Particles and Their Interactions*, Springer-Verlag Berlin Heidelberg, 1998.
- [22] F.Smarandache, *Paradoxist Geometry*, State Archives from Valcea, Rm. Valcea, Romania, 1969, and in *Paradoxist Mathematics*, Collected Papers (Vol. II), Kishinev University Press, Kishinev, 5-28, 1997.

## Mathematics with Natural Reality – Action Flows

**Abstract:** The universality of contradiction implies that the reality of a thing is only hold on observation with level dependent on the observer standing out or in and lead respectively to solvable equation or non-solvable equations on that thing for human beings. Notice that all contradictions are artificial, not the nature of things. Thus, holding on reality of things forces one extending contradictory systems in classical mathematics to a compatible one by combinatorial notion, particularly, *action flow* on differential equations, which is in fact an embedded oriented graph  $\vec{G}$  in a topological space  $\mathcal{S}$  associated with a mapping  $L : (v, u) \rightarrow L(v, u)$ , 2 end-operators  $A_{vu}^+ : L(v, u) \rightarrow L^{A_{vu}^+}(v, u)$  and  $A_{uv}^+ : L(u, v) \rightarrow L^{A_{uv}^+}(u, v)$  on a Banach space  $\mathcal{B}$  with  $L(v, u) = -L(u, v)$  and  $A_{vu}^+(-L(v, u)) = -L^{A_{vu}^+}(v, u)$  for  $\forall (v, u) \in E(\vec{G})$  holding with conservation laws

$$\sum_{u \in N_G(v)} L^{A_{vu}^+}(v, u) = \mathbf{0}, \quad \forall v \in V(\vec{G}).$$

The main purpose of this paper is to survey the powerful role of action flows to mathematics such as those of extended Banach  $\vec{G}$ -flow spaces, the representation theorem of Fréchet and Riesz on linear continuous functionals, geometry on action flows or non-solvable systems of solvable differential equations with global stability,  $\dots$  etc., and their applications to physics, ecology and other sciences. All of these makes it clear that knowing on the reality by solvable equations is local, only on coherent behaviors but by action flow on equations and generally, contradictory system is universal, which is nothing else but a mathematical combinatorics.

**Key Words:** Action flow,  $\vec{G}$ -flow, natural reality, observation, Smarandache multi-space, differential equation, topological graph, CC conjecture.

**AMS(2010):** 03A10,05C15,20A05, 34A26,35A01,51A05,51D20,53A35.

### §1. Introduction

A thing  $P$  is usually complex, even hybrid with other things but the understanding of human beings is bounded, brings about a unilateral knowledge on  $P$  identified with its known characters, gradually little by little. For example, let  $\mu_1, \mu_2, \dots, \mu_n$  be its known and  $\nu_i, i \geq 1$  unknown characters at time  $t$ . Then, thing  $P$  is understood by

$$P = \left( \bigcup_{i=1}^n \{\mu_i\} \right) \cup \left( \bigcup_{k \geq 1} \{\nu_k\} \right), \quad (1.1)$$

---

<sup>1</sup>A plenary talk in the *National Conference on Emerging Trends in Mathematics and Mathematical Sciences*, Calcutta Mathematical Society, December 17 - 19, 2015, Kolkata, India.

<sup>2</sup>*Bull. Cal. Math. Soc.*, **107**,(6)443 – 474(2015)

i.e., a *Smarandache multispace* in logic with an approximation  $P^\circ = \bigcup_{i=1}^n \{\mu_i\}$  at time  $t$ , reveals the diversity of things such as those shown in Fig.1 for the universe,



**Fig.1**

and that the reality of a thing  $P$  is nothing else but the state characters (1.1) of existed, existing or will existing things whether or not they are observable or comprehensible by human beings from a macro observation at a time  $t$ .

Generally, one establishes mathematical equation

$$\mathcal{F}(t, x_1, x_2, x_3, \psi_t, \psi_{x_1}, \psi_{x_2}, \dots, \psi_{x_1 x_2}, \dots) = 0 \quad (1.2)$$

to determine the behavior of a thing  $P$ , for instance the Schrödinger equation

$$i\hbar \frac{\partial \psi}{\partial t} = -\frac{\hbar^2}{2m} \nabla^2 \psi + U \psi \quad (1.3)$$

on particles, where  $\hbar = 6.582 \times 10^{-22} \text{MeVs}$  is the Planck constant. *Can we conclude the mathematical equation (1.2) characterize the reality of thing  $P$  by solution  $\psi$ ?* The answer is not certain, particularly, for the equation (1.3) on the superposition, i.e., in two or more possible states of being of particles, but the solution  $\psi$  of (1.3) characterizes only its one position.

Notice that things are inherently related, not isolated in the nature, observed characters are filtering sensory information on things. Whence these is a topological structure on things, i.e., an inherited topological graph  $G$  in space. On the other hand, any oriented graph  $G = (V, \vec{E})$  can be embedded into  $\mathbb{R}^n$  if  $n \geq 3$  because if there is an intersection  $p$  between edges  $\varphi(e)$  and  $\varphi(e')$  in embedding  $(G, \varphi)$  of  $G$ , we can always operate a surgery on curves  $\varphi(e)$  and  $\varphi(e')$  in a sufficient small neighborhood  $N(p)$  of  $p$  such that there are no intersections again and this surgery can be operated on all intersections in  $(G, \varphi)$ . Furthermore, if  $G$  is simple, i.e., without loops or multiple edges, we can choose  $n$  points  $v_1 = (t_1, t_1^2, t_1^3)$ ,  $v_2 = (t_2, t_2^2, t_2^3)$ ,  $\dots$ ,  $v_n = (t_n, t_n^2, t_n^3)$  for different  $t_i$ ,  $1 \leq i \leq n$ ,  $n = |G|$  on curve  $(t, t^2, t^3)$ . Then it is clear that the straight lines  $v_i v_j$ ,  $v_k v_l$  have no intersections for any integers  $1 \leq i, j, k, l \leq n$  ([26]). Thus, there is such a mapping  $\varphi$  in this case that all edges of  $(G, \varphi)$  are straight segments, i.e., rectilinear embedding in  $\mathbb{R}^n$  for  $G$  if  $n \geq 3$ . We therefore conclude that

*Oriented Graphs in  $\mathbb{R}^n \Leftrightarrow$  Inherent Structure of Natural Things.*



Thus, for understanding the reality, particularly, multiple behavior of a thing  $P$ , an effective way is return  $P$  to its nature and establish a mathematical theory on embedded graphs in  $\mathbb{R}^n$ ,  $n \geq 3$ , which is nothing else but *flows* in dynamical mechanics, such as the water flow in a river shown in Fig.2.



Fig.2

There are two commonly properties known to us on water flows. Thus, the rate of flow is continuous on time  $t$ , and for its any cross section  $C$ , the in-flow is always equal to the out-flow on  $C$ . Then, *how can we describe the water flow in Fig.2 on there properties?* Certainly, we can characterize it by network flows simply. A network is nothing else but an oriented graph  $G = (V, \vec{E})$  with a continuous function  $f : \vec{E} \rightarrow \mathbb{R}$  holding with conditions  $f(u, v) = -f(v, u)$  for  $\forall (u, v) \in \vec{E}$  and  $\sum_{u \in N_G(v)} f(v, u) = 0$ . For example, the network shown in Fig.3 is the abstracted model for water flow in Fig.2 with conservation equation  $a(t) = b(t) + c(t)$ , where  $a(t), b(t)$  and  $c(t)$  are the rates of flow on time  $t$  at the cross section of the river.

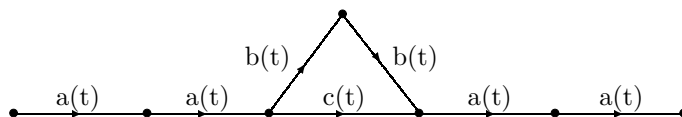

Fig.3

A further generalization of network by extending flows to elements in a Banach space with actions results in action flow following.

**Definition 1.1** An action flow  $(\vec{G}; L, A)$  is an oriented embedded graph  $\vec{G}$  in a topological space  $\mathcal{S}$  associated with a mapping  $L : (v, u) \rightarrow L(v, u)$ , 2 end-operators  $A_{vu}^+ : L(v, u) \rightarrow L^{A_{vu}^+}(v, u)$  and  $A_{uv}^+ : L(u, v) \rightarrow L^{A_{uv}^+}(u, v)$  on a Banach space  $\mathcal{B}$  with  $L(v, u) = -L(u, v)$  and  $A_{vu}^+(-L(v, u)) = -L^{A_{vu}^+}(v, u)$  for  $\forall (v, u) \in E(\vec{G})$

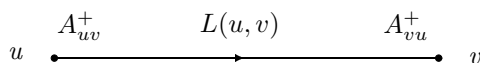
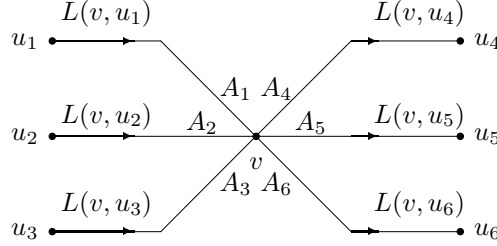

Fig.4

holding with conservation laws

$$\sum_{u \in N_G(v)} L^{A_{vu}^+}(v, u) = \mathbf{0} \quad \text{for } \forall v \in V(\vec{G})$$

such as those shown for vertex  $v$  in Fig.5 following



**Fig.5**

with a conservation law

$$-L^{A_1}(v, u_1) - L^{A_2}(v, u_2) - L^{A_3}(v, u_3) + L^{A_4}(v, u_4) + L^{A_5}(v, u_5) + L^{A_6}(v, u_6) = \mathbf{0},$$

where an embedding of  $G$  in  $\mathcal{S}$  is a 2-tuple  $(G, \varphi)$  with a 1-1 continuous mapping  $\varphi : G \rightarrow \mathcal{S}$  such that an intersection only appears at end vertices of  $G$  in  $\mathcal{S}$ , i.e.,  $\varphi(p) \neq \varphi(q)$  if  $p \neq q$  for  $\forall p, q \in G$ .

Notice that action flows is also an expression of the *CC conjecture*, i.e., *any mathematical science can be reconstructed from or made by combinatorialization* ([7], [20]). But they are elements for hold on the nature of things.

The main purpose of this paper is to survey the powerful role of action flows in mathematics and other sciences such as those of extended Banach  $\vec{G}$ -flow spaces, the representation theorem of Fréchet and Riesz on linear continuous functionals, , geometry on action flows and geometry on non-solvable systems of solvable differential equations, combinatorial manifolds, global stability of action flows,  $\dots$ , etc. on two cases following with applications to physics and other sciences:

**Case 1.**  $\vec{G}$ -flows, i.e., action flows  $(\vec{G}; L, \mathbf{1}_{\mathcal{S}})$ , which enable one extending Banach space to Banach  $\vec{G}$ -flow space and find new interpretations on physical phenomena. Notices that an action flow with  $A_{vu}^+ = A_{uv}^+$  for  $\forall (v, u) \in E(\vec{G})$  is itself a  $\vec{G}$ -flow if replacing  $L(u, v)$  by  $L^{A_{vu}^+}(v, u)$  on  $(v, u)$ .

**Case 2.** *Differential flows*, i.e., action flows  $(\vec{G}; L, A)$  with ordinary differential or partial differential operators  $A_{vu}^+$  on some edges  $(v, u) \in E(\vec{G})$ , which includes classical geometrical flow as the particular in cases of  $|\vec{G}| = 1$ . Usually, if  $|\vec{G}| \geq 2$ , such a flow characterizes non-solvable system of physical equations.

For example, let the  $L : (v, u) \rightarrow L(v, u) \in \mathbb{R}^n \times \mathbb{R}^+$  with action operators  $A_{vu}^+ = a_{vu} \frac{\partial}{\partial t}$

and  $a_{vu} : \mathbb{R}^n \rightarrow \mathbb{R}$  for any edge  $(v, u) \in E(\vec{G})$  in Fig.6 following.

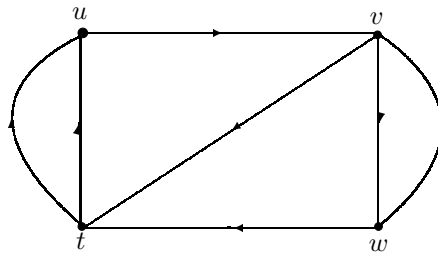

Fig.6

Then the conservation laws are partial differential equations

$$\begin{cases} a_{tu^1} \frac{\partial L(t, u)^1}{\partial t} + a_{tu^2} \frac{\partial L(t, u)^2}{\partial t} = a_{uv} \frac{\partial L(u, v)}{\partial t} \\ a_{uv} \frac{\partial L(u, v)}{\partial t} = a_{vw^1} \frac{\partial L(v, w)^1}{\partial t} + a_{vw^2} \frac{\partial L(v, w)^2}{\partial t} + a_{vt} \frac{\partial L(v, t)}{\partial t} \\ a_{vw^1} \frac{\partial L(v, w)^1}{\partial t} + a_{vw^2} \frac{\partial L(v, w)^2}{\partial t} = a_{wt} \frac{\partial L(w, t)}{\partial t} \\ a_{wt} \frac{\partial L(w, t)}{\partial t} + a_{vt} \frac{\partial L(v, t)}{\partial t} = a_{tu^1} \frac{\partial L(t, u)^1}{\partial t} + a_{tu^2} \frac{\partial L(t, u)^2}{\partial t} \end{cases}$$

For terminologies and notations not mentioned here, we follow references [1] for mechanics, [2] for functional analysis, [11] for graphs and combinatorial geometry, [4] and [27] for differential equations, [22] for elementary particles, and [23] for Smarandache multispaces.

§2.  $\vec{G}$ -Flows

The divisibility of matter initiates human beings to search elementary constituting cells of matter and interpretation on the superposition of microcosmic particles such as those of quarks, leptons with those of their antiparticles, and unmatters between a matter and its antimatter([24-25]). For example, baryon and meson are predominantly formed respectively by three or two quarks in the model of Sakata, or Gell-Mann and Ne’eman, and H.Everett’s multiverse ([5]) presented an interpretation for the cat in Schrödinger’s paradox in 1957, such as those shown in Fig.7.

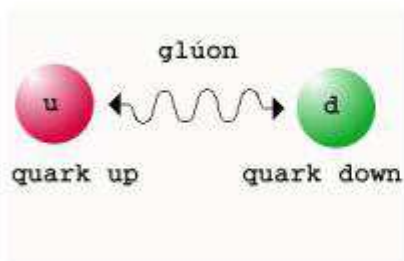

Quark Model

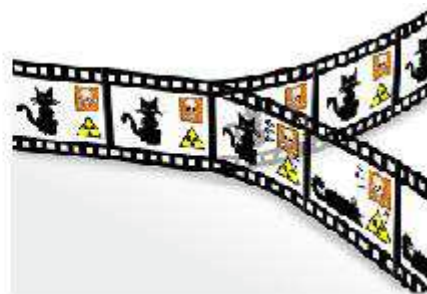

Multiverse on Schrödinger’s Cat

Fig.7

Notice that we only hold coherent behaviors by an equation on a natural thing, not the individual because that equation is established by viewing abstractly a particle to be a geometrical point or an independent field from a macroscopic point, which leads physicists always assuming the internal structures mechanically for hold on the behaviors of matters, likewise Sakata, Gell-Mann, Ne’eman or H.Everett. However, such an assumption is a little ambiguous in mathematics, i.e., we can not even conclude which is the point or the independent field, the matter or its submatter. But  $\vec{G}$ -flows verify the rightness of physicists ([17]).

## 2.1 Algebra on Graphs

Let  $\vec{G}$  be an oriented graph embedded in  $\mathbb{R}^n, n \geq 3$  and let  $(\mathcal{A}; \circ)$  be an algebraic system in classical mathematics, i.e., for  $\forall a, b \in \mathcal{A}, a \circ b \in \mathcal{A}$ . Denoted by  $\vec{G}_{\mathcal{A}}^L$  all of those labeled graphs  $\vec{G}^L$  with labeling  $L : E(\vec{G}) \rightarrow \mathcal{A}$ . We extend operation  $\circ$  on elements in  $\vec{G}_{\mathcal{A}}^L$  by a ruler following:

**R :** For  $\forall \vec{G}^{L_1}, \vec{G}^{L_2} \in \vec{G}_{\mathcal{A}}^L$ , define  $\vec{G}^{L_1} \circ \vec{G}^{L_2} = \vec{G}^{L_1 \circ L_2}$ , where  $L_1 \circ L_2 : e \rightarrow L_1(e) \circ L_2(e)$  for  $\forall e \in E(\vec{G})$ .

For example, such an extension on graph  $\vec{C}_4$  is shown in Fig.8, where,  $\mathbf{a}_3 = \mathbf{a}_1 \circ \mathbf{a}_2$ ,  $\mathbf{b}_3 = \mathbf{b}_1 \circ \mathbf{b}_2$ ,  $\mathbf{c}_3 = \mathbf{c}_1 \circ \mathbf{c}_2$ ,  $\mathbf{d}_3 = \mathbf{d}_1 \circ \mathbf{d}_2$ .

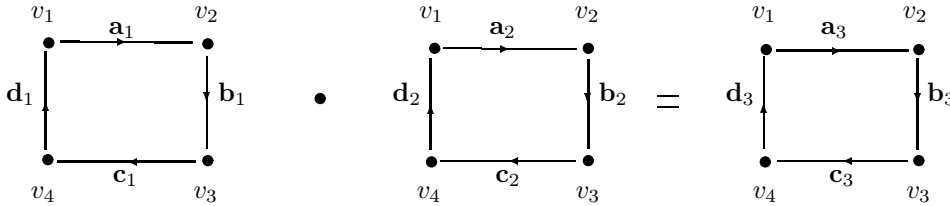

Fig.8

Notice that  $\vec{G}_{\mathcal{A}}^L$  is also an algebraic system under ruler **R**, i.e.,  $\vec{G}^{L_1} \circ \vec{G}^{L_2} \in \vec{G}_{\mathcal{A}}^L$  by definition. Furthermore,  $\vec{G}_{\mathcal{A}}^L$  is a group if  $(\mathcal{A}, \circ)$  is a group because of

(1)  $(\vec{G}^{L_1} \circ \vec{G}^{L_2}) \circ \vec{G}^{L_3} = \vec{G}^{L_1} \circ (\vec{G}^{L_2} \circ \vec{G}^{L_3})$  for  $\forall \vec{G}^{L_1}, \vec{G}^{L_2}, \vec{G}^{L_3} \in \vec{G}_{\mathcal{A}}^L$  because  $(L_1(e) \circ L_2(e)) \circ L_3(e) = L_1(e) \circ (L_2(e) \circ L_3(e))$  for  $e \in E(\vec{G})$ .

(2) there is an identify  $\vec{G}^{L_{1_{\mathcal{A}}}}$  in  $\vec{G}_{\mathcal{A}}^L$ , where  $L_{1_{\mathcal{A}}} : e \rightarrow 1_{\mathcal{A}}$  for  $\forall e \in E(\vec{G})$ ;

(3) there is an uniquely element  $\vec{G}^{L^{-1}}$  holding with  $\vec{G}^{L^{-1}} \circ \vec{G}^L = \vec{G}^{L_{1_{\mathcal{A}}}}$  for  $\forall \vec{G}^L \in \vec{G}_{\mathcal{A}}^L$ .

Thus, an algebraic system can be naturally extended on an embedded graph, and this fact holds also with those of algebraic systems of multi-operations. For example, let  $\mathcal{R} = (R; +, \cdot)$  be a ring and  $(\mathcal{V}; +, \cdot)$  a vector space over field  $\mathcal{F}$ . Then it is easily know that  $\vec{G}_{\mathcal{R}}^L, \vec{G}_{\mathcal{V}}^L$  are respectively a ring or a vector space with zero vector  $\mathbf{O} = \vec{G}^{L_0}$ , where  $L_0 : e \rightarrow \mathbf{O}$  for  $\forall e \in E(\vec{G})$ , such as those shown for  $\vec{G}_{\mathcal{V}}^L$  on  $\vec{C}_4$  in Fig.8 with  $\mathbf{a}, \mathbf{b}, \mathbf{c}, \mathbf{d}, \mathbf{a}_i, \mathbf{b}_i, \mathbf{c}_i, \mathbf{d}_i \in \mathcal{V}$  for  $i = 1, 2, 3$ ,  $\mathbf{x}_3 = \mathbf{x}_1 + \mathbf{x}_2$  for  $\mathbf{x} = \mathbf{a}, \mathbf{b}, \mathbf{c}$  or  $\mathbf{d}$  and  $\alpha \in \mathcal{F}$ .

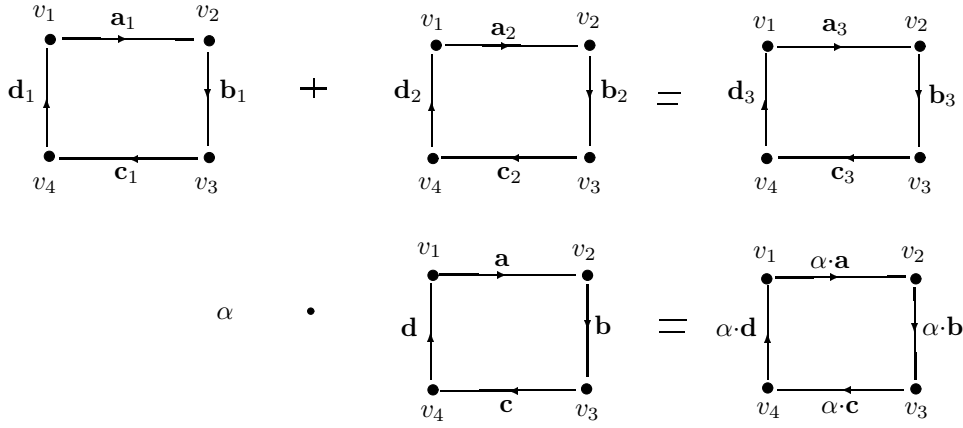

Fig.9

## 2.2 Action Flow Spaces

Notice that the algebra on graphs only is a formally operation system provided without the characteristics of flows, particularly, conservation, which can not be a portrayal of a natural thing because a measurable property of a physical system is usually conserved with connections. The notion wishing those of algebra on graphs with conservation naturally leads to that  $\vec{G}$ -flows, i.e., action flows  $(\vec{G}; L, \mathbf{1}_{\mathcal{V}})$  come into being. Thus, a  $\vec{G}$ -flow is a subfamily of  $\vec{G}^L_{\mathcal{V}}$  limited by conservation laws. For example, if  $\vec{G} = \vec{C}_4$ , there must be  $\mathbf{a}=\mathbf{b}=\mathbf{c}=\mathbf{d}$  and  $\mathbf{a}_i=\mathbf{b}_i=\mathbf{c}_i=\mathbf{d}_i$  for  $i = 1, 2, 3$  in Fig.9. Clearly, all  $\vec{G}$ -flows  $(\vec{G}; L, \mathbf{1}_{\mathcal{V}})$  on  $\vec{G}$  for a vector space  $V$  over field  $\mathcal{F}$  form a vector space by ruler  $\mathbf{R}$ , denoted by  $\vec{G}^{\mathcal{V}}$ .

Generally, a *conservative action family* is a pair  $\{\{\mathbf{v}\}, \{\mathbf{A}(\mathbf{v})\}\}$  with vectors  $\{\mathbf{v}\} \subset \mathcal{V}$  and operators  $A$  on  $\mathcal{V}$  such that  $\sum_{\mathbf{v} \in V} \mathbf{v}^{A(\mathbf{v})} = \mathbf{0}$ . Clearly, action flow consists of conservation action families. The result following establishes its inverse.

**Theorem 2.1**([17]) *An action flow  $(\vec{G}; L, A)$  exists on  $\vec{G}$  if and only if there are conservation action families  $L(v)$  in a Banach space  $\mathcal{V}$  associated an index set  $V$  with*

$$L(v) = \{L^{A^+_{vu}}(v, u) \in \mathcal{V} \text{ for some } u \in V\}$$

such that  $A^+_{vu}(-L(v, u)) = -L^{A^+_{vu}}(v, u)$  and

$$L(v) \cap (-L(u)) = L(v, u) \text{ or } \emptyset.$$

## 2.3 Banach $\vec{G}$ -Flow Space

Let  $(\mathcal{V}; +, \cdot)$  be a Banach or Hilbert space with inner product  $\langle \cdot, \cdot \rangle$ . We can furthermore

introduce the *norm* and *inner product* on  $\vec{G}^{\mathcal{V}}$  by

$$\|\vec{G}^L\| = \sum_{(u,v) \in E(\vec{G})} \|L(u,v)\|$$

and

$$\langle \vec{G}^{L_1}, \vec{G}^{L_2} \rangle = \sum_{(u,v) \in E(\vec{G})} \langle L_1(u,v), L_2(u,v) \rangle$$

for  $\forall \vec{G}^L, \vec{G}^{L_1}, \vec{G}^{L_2} \in \vec{G}^{\mathcal{V}}$ , where  $\|L(u,v)\|$  is the norm of  $L(u,v)$  in  $\mathcal{V}$ .

Then, it can be easily verified that ([17]):

- (1)  $\|\vec{G}^L\| \geq 0$  and  $\|\vec{G}^L\| = 0$  if and only if  $\vec{G}^L = \mathbf{O}$ ;
- (2)  $\|\vec{G}^{\xi L}\| = \xi \|\vec{G}^L\|$  for any scalar  $\xi$ ;
- (3)  $\|\vec{G}^{L_1} + \vec{G}^{L_2}\| \leq \|\vec{G}^{L_1}\| + \|\vec{G}^{L_2}\|$ ;
- (4)  $\langle \vec{G}^L, \vec{G}^L \rangle \geq 0$  and  $\langle \vec{G}^L, \vec{G}^L \rangle = 0$  if and only if  $\vec{G}^L = \mathbf{O}$ ;
- (5)  $\langle \vec{G}^{L_1}, \vec{G}^{L_2} \rangle = \overline{\langle \vec{G}^{L_2}, \vec{G}^{L_1} \rangle}$  for  $\forall \vec{G}^{L_1}, \vec{G}^{L_2} \in \vec{G}^{\mathcal{V}}$ ;
- (6) For  $\vec{G}^L, \vec{G}^{L_1}, \vec{G}^{L_2} \in \vec{G}^{\mathcal{V}}$  and  $\lambda, \mu \in \mathcal{F}$ ,

$$\langle \lambda \vec{G}^{L_1} + \mu \vec{G}^{L_2}, \vec{G}^L \rangle = \lambda \langle \vec{G}^{L_1}, \vec{G}^L \rangle + \mu \langle \vec{G}^{L_2}, \vec{G}^L \rangle.$$

Thus,  $\vec{G}^{\mathcal{V}}$  is also a normed space by (1)-(3) or inner space by (4)-(6). By showing that any Cauchy sequence in  $\vec{G}^{\mathcal{V}}$  is converged also holding with conservation laws in [17], we know the result following.

**Theorem 2.2** For any oriented graph  $\vec{G}$  embedded in topological space  $\mathcal{S}$ ,  $\vec{G}^{\mathcal{V}}$  is a Banach space, and furthermore, if  $\mathcal{V}$  is a Hilbert space, so is  $\vec{G}^{\mathcal{V}}$ .

A  $\vec{G}^L$ -flow is *orthogonal* to  $\vec{G}^{L'}$  if  $\langle \vec{G}^L, \vec{G}^{L'} \rangle = \mathbf{O}$ . We know the orthogonal decomposition of Hilbert space  $\vec{G}^{\mathcal{V}}$  following.

**Theorem 2.3**([17]) Let  $\mathcal{V}$  be a Hilbert space with an orthogonal decomposition  $\mathcal{V} = \mathbf{V} \oplus \mathbf{V}^\perp$  for a closed subspace  $\mathbf{V} \subset \mathcal{V}$ . Then there is also an orthogonal decomposition

$$\vec{G}^{\mathcal{V}} = \tilde{\mathbf{V}} \oplus \tilde{\mathbf{V}}^\perp,$$

where,  $\tilde{\mathbf{V}} = \{ \vec{G}^{L_1} \in \vec{G}^{\mathcal{V}} \mid L_1 : X(\vec{G}) \rightarrow \mathbf{V} \}$  and  $\tilde{\mathbf{V}}^\perp = \{ \vec{G}^{L_2} \in \vec{G}^{\mathcal{V}} \mid L_2 : X(\vec{G}) \rightarrow \mathbf{V}^\perp \}$ , i.e., for  $\forall \vec{G}^L \in \vec{G}^{\mathcal{V}}$ , there is a uniquely decomposition  $\vec{G}^L = \vec{G}^{L_1} + \vec{G}^{L_2}$  with  $L_1 : X(\vec{G}) \rightarrow \mathbf{V}$  and  $L_2 : X(\vec{G}) \rightarrow \mathbf{V}^\perp$ .

### 2.4 Actions on $\vec{G}$ -Flow Spaces

Let  $\mathcal{V}$  be a Hilbert space consisting of measurable functions  $f(x_1, x_2, \dots, x_n)$  on the functional space  $L^2[\Delta]$  with inner product

$$\langle f(\mathbf{x}), g(\mathbf{x}) \rangle = \int_{\Delta} \overline{f(\mathbf{x})} g(\mathbf{x}) d\mathbf{x} \text{ for } f(\mathbf{x}), g(\mathbf{x}) \in L^2[\Delta]$$

and

$$D = \sum_{i=1}^n a_i \frac{\partial}{\partial x_i} \quad \text{and} \quad \int_{\Delta}, \quad \overline{\int}_{\Delta}$$

are respectively differential operators and integral operators linearly defined by  $D\vec{G}^L = \vec{G}^{DL(u,v)}$  and

$$\begin{aligned} \int_{\Delta} \vec{G}^L &= \int_{\Delta} K(\mathbf{x}, \mathbf{y}) \vec{G}^L[\mathbf{y}] d\mathbf{y} = \vec{G} \int_{\Delta} K(\mathbf{x}, \mathbf{y}) L(u,v)[\mathbf{y}] d\mathbf{y}, \\ \overline{\int}_{\Delta} \vec{G}^L &= \int_{\Delta} \overline{K(\mathbf{x}, \mathbf{y})} \vec{G}^L[\mathbf{y}] d\mathbf{y} = \vec{G} \int_{\Delta} \overline{K(\mathbf{x}, \mathbf{y})} L(u,v)[\mathbf{y}] d\mathbf{y} \end{aligned}$$

for  $\forall(u, v) \in E(\vec{G})$ , where  $a_i, \frac{\partial a_i}{\partial x_j} \in \mathbb{C}^0(\Delta)$  for integers  $1 \leq i, j \leq n$  and  $K(\mathbf{x}, \mathbf{y}) : \Delta \times \Delta \rightarrow \mathbb{C} \in L^2(\Delta \times \Delta, \mathbb{C})$  with

$$\int_{\Delta \times \Delta} K(\mathbf{x}, \mathbf{y}) d\mathbf{x} d\mathbf{y} < \infty.$$

For example, let let  $f(t) = t, g(t) = e^t, K(t, \tau) = t^2 + \tau^2$  for  $\Delta = [0, 1]$  and let  $\vec{G}^L$  be the  $\vec{G}$ -flow shown on the left in Fig.10,

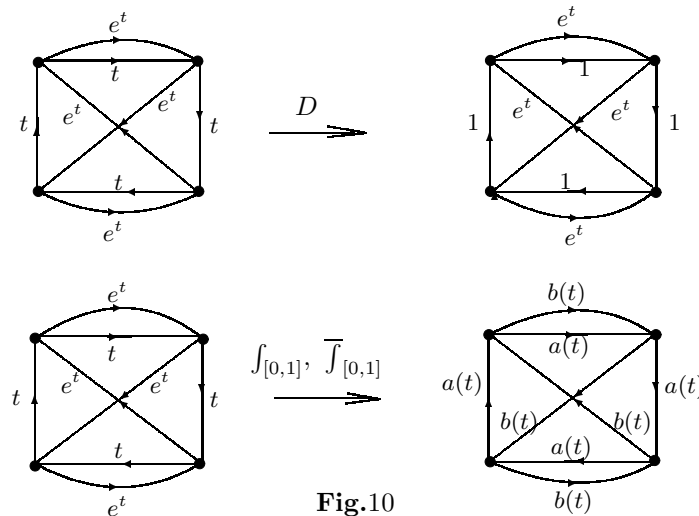

Fig.10

where  $a(t) = \frac{t^2}{2} + \frac{1}{4}$  and  $b(t) = (e - 1)t^2 + e - 2$ . We know the result following.

**Theorem 2.4**([17])  $D : \vec{G}^{\mathcal{V}} \rightarrow \vec{G}^{\mathcal{V}}$  and  $\int_{\Delta} : \vec{G}^{\mathcal{V}} \rightarrow \vec{G}^{\mathcal{V}}$ .

Thus, operators  $D, \int_{\Delta}$  and  $\overline{\int}_{\Delta}$  are linear operators action on  $\overrightarrow{G}^{\mathcal{V}}$ .

Generally, let  $\mathcal{V}$  be Banach space  $\mathcal{V}$  over a field  $\mathcal{F}$ . An operator  $\mathbf{T} : \overrightarrow{G}^{\mathcal{V}} \rightarrow \overrightarrow{G}^{\mathcal{V}}$  is linear if

$$\mathbf{T} \left( \lambda \overrightarrow{G}^{L_1} + \mu \overrightarrow{G}^{L_2} \right) = \lambda \mathbf{T} \left( \overrightarrow{G}^{L_1} \right) + \mu \mathbf{T} \left( \overrightarrow{G}^{L_2} \right)$$

for  $\forall \overrightarrow{G}^{L_1}, \overrightarrow{G}^{L_2} \in \overrightarrow{G}^{\mathcal{V}}$  and  $\lambda, \mu \in \mathcal{F}$ , and is continuous at a  $\overrightarrow{G}$ -flow  $\overrightarrow{G}^{L_0}$  if there always exist such a number  $\delta(\varepsilon)$  for  $\forall \varepsilon > 0$  that

$$\left\| \mathbf{T} \left( \overrightarrow{G}^L \right) - \mathbf{T} \left( \overrightarrow{G}^{L_0} \right) \right\| < \varepsilon \quad \text{if} \quad \left\| \overrightarrow{G}^L - \overrightarrow{G}^{L_0} \right\| < \delta(\varepsilon).$$

The following result extends the Fréchet and Riesz representation theorem on linear continuous functionals to linear functionals  $\mathbf{T} : \overrightarrow{G}^{\mathcal{V}} \rightarrow \mathbb{C}$  on  $\overrightarrow{G}$ -flow space  $\overrightarrow{G}^{\mathcal{V}}$ , where  $\mathbb{C}$  is the complex field.

**Theorem 2.5**([17]) *Let  $\mathbf{T} : \overrightarrow{G}^{\mathcal{V}} \rightarrow \mathbb{C}$  be a linear continuous functional, where  $\mathcal{V}$  is a Hilbert space. Then there is a unique  $\overrightarrow{G}^{\hat{L}} \in \overrightarrow{G}^{\mathcal{V}}$  such that  $\mathbf{T} \left( \overrightarrow{G}^L \right) = \left\langle \overrightarrow{G}^L, \overrightarrow{G}^{\hat{L}} \right\rangle$  for  $\forall \overrightarrow{G}^L \in \overrightarrow{G}^{\mathcal{V}}$ .*

### 2.5 $\overrightarrow{G}$ -Flows on Equations

Let  $\overrightarrow{G}$  be an oriented graph embedded in space  $\mathbb{R}^n, n \geq 3$  and let

$$f(x_1, x_2, \dots, x_n) = 0$$

be a solvable equation in a field  $\mathcal{F}$ . We are naturally consider its  $\mathcal{F}$ -extension equation

$$f(X_1, X_2, \dots, X_n) = \mathbf{0}$$

in  $\overrightarrow{G}^{\mathcal{F}}$  by viewing an element  $b \in \mathcal{F}$  as  $b = \overrightarrow{G}^L$  if  $L(u, v) = b$  for  $(u, v) \in X \left( \overrightarrow{G} \right)$  and  $0 \neq a \in \mathcal{F}$ . For example, the extension of equation  $ax = b$  is  $\overrightarrow{G}^{L_a} X = \overrightarrow{G}^{L_b}$  in  $\overrightarrow{G}^{\mathcal{F}}$  with a  $\overrightarrow{G}$ -flow solution  $x = \overrightarrow{G}^{a^{-1}L}$ , such as those shown in Fig.11 for  $\overrightarrow{G} = \overrightarrow{C}_4, a = 3$  and  $b = 5$ . Thus we can entrust a combinatorial structure  $\overrightarrow{G}$  on its solution.

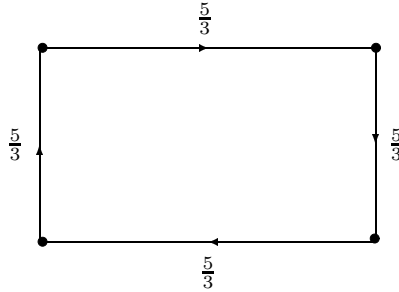

**Fig.11**

Generally, for a solvable system of linear equations, let  $[L_{ij}]_{m \times n}$  be a matrix with entries  $L_{ij} : u^v \rightarrow \mathcal{V}$ . Denoted by  $[L_{ij}]_{m \times n}(u, v)$  the matrix  $[L_{ij}(u, v)]_{m \times n}$ . A result on  $\overrightarrow{G}$ -flow





For an integral kernel  $K(\mathbf{x}, \mathbf{y})$ ,  $\mathcal{N}, \mathcal{N}^* \subset L^2[\Delta]$  are defined respectively by

$$\begin{aligned}\mathcal{N} &= \left\{ \phi(\mathbf{x}) \in L^2[\Delta] \mid \int_{\Delta} K(\mathbf{x}, \mathbf{y}) \phi(\mathbf{y}) d\mathbf{y} = \phi(\mathbf{x}) \right\}, \\ \mathcal{N}^* &= \left\{ \varphi(\mathbf{x}) \in L^2[\Delta] \mid \int_{\Delta} \overline{K(\mathbf{x}, \mathbf{y})} \varphi(\mathbf{y}) d\mathbf{y} = \varphi(\mathbf{x}) \right\}.\end{aligned}$$

Then

**Theorem 2.8**([17]) For  $\forall G^L \in \vec{G}^{\mathcal{V}}$ , if  $\dim \mathcal{N} = 0$  the integral equation

$$\vec{G}^X - \int_{\Delta} \vec{G}^X = G^L$$

is solvable in  $\vec{G}^{\mathcal{V}}$  with  $\mathcal{V} = L^2[\Delta]$  if and only if

$$\langle \vec{G}^L, \vec{G}^{L'} \rangle = 0, \quad \forall \vec{G}^{L'} \in \mathcal{N}^*.$$

In fact, if  $\vec{G}$  is circuit decomposable, we can generally extend solutions of an equation to  $\vec{G}$ -flows following.

**Theorem 2.9**([17]) If the topological graph  $\vec{G}$  is strong-connected with circuit decomposition  $\vec{G} = \bigcup_{i=1}^l \vec{C}_i$  such that  $L(e) = L_i(\mathbf{x})$  for  $\forall e \in E(\vec{C}_i)$ ,  $1 \leq i \leq l$  and the Cauchy problem

$$\begin{cases} \mathcal{F}_i(\mathbf{x}, u, u_{x_1}, \dots, u_{x_n}, u_{x_1 x_2}, \dots) = 0 \\ u|_{\mathbf{x}_0} = L_i(\mathbf{x}) \end{cases}$$

is solvable in a Hilbert space  $\mathcal{V}$  on domain  $\Delta \subset \mathbb{R}^n$  for integers  $1 \leq i \leq l$ , then the Cauchy problem

$$\begin{cases} \mathcal{F}_i(\mathbf{x}, X, X_{x_1}, \dots, X_{x_n}, X_{x_1 x_2}, \dots) = 0 \\ X|_{\mathbf{x}_0} = \vec{G}^L \end{cases}$$

such that  $L(e) = L_i(\mathbf{x})$  for  $\forall e \in E(\vec{C}_i)$  is solvable for  $X \in \vec{G}^{\mathcal{V}}$ .

### §3. Geometry on Action Flows

In physics, a thing  $P$ , particularly, a particle such as those of water molecule  $H_2O$  and its hydrogen or oxygen atom shown in Fig.12 is characterized by differential equation established on observed characters of  $\mu_1, \mu_2, \dots, \mu_n$  for its state function  $\psi(t, x)$  by the principle of stationary action  $\delta S = 0$  in  $\mathbb{R}^4$  with

$$S = \int_{t_1}^{t_2} dt L(q(t), \dot{q}(t)) \quad \text{or} \quad S = \int_{\tau_2}^{\tau_1} d^4x \mathcal{L}(\phi, \partial_\mu \psi), \quad (3.1)$$

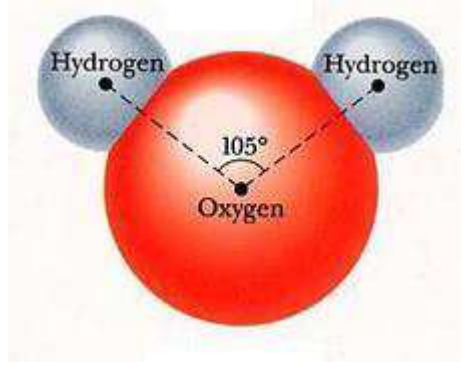

Fig.12

i.e., the *Euler-Lagrange equations*

$$\frac{\partial L}{\partial q} - \frac{d}{dt} \frac{\partial L}{\partial \dot{q}} = 0 \quad \text{and} \quad \frac{\partial \mathcal{L}}{\partial \psi} - \partial_\mu \frac{\partial \mathcal{L}}{\partial (\partial_\mu \psi)} = 0, \quad (3.2)$$

where  $q(t), \dot{q}(t), \psi$  are the generalized coordinates, the velocities, the state function, and  $L(q(t), \dot{q}(t)), \mathcal{L}$  are the *Lagrange function* or *density* on  $P$ , respectively by viewing  $P$  as an independent system or a field.

For examples, let

$$\mathcal{L}_S = \frac{i\hbar}{2} \left( \frac{\partial \psi}{\partial t} \bar{\psi} - \frac{\partial \bar{\psi}}{\partial t} \psi \right) - \frac{1}{2} \left( \frac{\hbar^2}{2m} |\nabla \psi|^2 + V|\psi|^2 \right).$$

Then we get the Schrödinger equation by (1.3) and similarly, the Dirac equation

$$\left( i\gamma^\mu \partial_\mu - \frac{mc}{\hbar} \right) \psi(t, x) = 0 \quad (3.3)$$

for a free fermion  $\psi(t, x)$ , the Klein-Gordon equation

$$\left( \frac{1}{c^2} \frac{\partial^2}{\partial t^2} - \nabla^2 \right) \psi(x, t) + \left( \frac{mc}{\hbar} \right)^2 \psi(x, t) = 0 \quad (3.4)$$

for a free boson  $\psi(t, x)$  on particle with masses  $m$  hold in relativistic forms, where  $\hbar = 6.582 \times 10^{-22} MeVs$  is the Planck constant.

Notice that the equation (1.3) is dependent on observed characters  $\mu_1, \mu_2, \dots, \mu_n$  and different position maybe results in different observations. For example, if an observer receives information stands out of  $H_2O$  by viewing it as a geometrical point then he only receives coherent information on atoms  $H$  and  $O$  with  $H_2O$  ([18]), but if he enters the interior of the molecule, he will view a different sceneries for atom  $H$  and atom  $O$  with a non-solvable system

of 3 dynamical equations following ([19]).

$$\begin{cases} -i\hbar \frac{\partial \psi_O}{\partial t} = \frac{\hbar^2}{2m_O} \nabla^2 \psi_O - V(x)\psi_O \\ -i\hbar \frac{\partial \psi_{H_1}}{\partial t} = \frac{\hbar^2}{2m_{H_1}} \nabla^2 \psi_{H_1} - V(x)\psi_{H_1} \\ -i\hbar \frac{\partial \psi_{H_2}}{\partial t} = \frac{\hbar^2}{2m_{H_2}} \nabla^2 \psi_{H_2} - V(x)\psi_{H_2} \end{cases}$$

Thus, an in-observation on a physical thing  $P$  results in a non-solvable system of solvable equations, which is also in accordance with individual difference in epistemology. However, the atoms  $H$  and  $O$  are compatible in the water molecule  $H_2O$  without contradiction. Thus, accompanying with the establishment of compatible systems, we are also needed those of contradictory systems, particularly, non-solvable equations for holding on the reality of things ([15]).

### 3.1 Geometry on Equations

Physicist characterizes a natural thing usually by solutions of differential equations. However, if they are non-solvable such as those of equations for atoms  $H$  and  $O$  on in-observation, how to determine their behavior in the water molecule  $H_2O$ ? Holding on the reality of things motivates one to leave behind the solvability of equation, extend old notion to a new one by machinery. The knowledge of human beings concludes the social existence determine the consciousness. However, if we can not characterize a thing until today, we can never conclude that it is nothingness, particularly on those of non-solvable system consisting of solvable equations. For example, consider the two systems of linear equations following:

$$(LES_4^N) \begin{cases} x + y = 1 \\ x + y = -1 \\ x - y = -1 \\ x - y = 1 \end{cases} \qquad (LES_4^S) \begin{cases} x = y \\ x + y = 2 \\ x = 1 \\ y = 1 \end{cases}$$

Clearly,  $(LES_4^N)$  is non-solvable because  $x + y = -1$  is contradictious to  $x + y = 1$ , and so  $x - y = -1$  to  $x - y = 1$ . But  $(LES_4^S)$  is solvable with  $x = 1$  and  $y = 1$ .

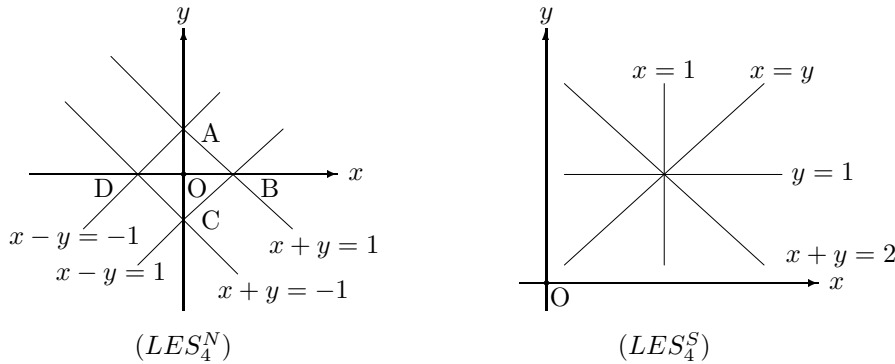

Fig.13

What is the geometrical essence of a system of linear equations? In fact, each linear equation  $ax + by = c$  with  $ab \neq 0$  is in fact a point set  $L_{ax+by=c} = \{(x, y) | ax + by = c\}$  in  $\mathbb{R}^2$ , such as those shown in Fig.13 for the linear systems  $(LES_4^N)$  and  $(LES_4^S)$ .

Clearly,

$$L_{x+y=1} \cap L_{x+y=-1} \cap L_{x-y=1} \cap L_{x-y=-1} = \emptyset$$

but

$$L_{x=y} \cap L_{x+y=2} \cap L_{x=1} \cap L_{y=1} = (1, 1)$$

in the Euclidean plane  $\mathbb{R}^2$ .

Generally, a solution manifold of an equation  $f(x_1, x_2, \dots, x_n, y) = 0, n \geq 1$  is defined to be an  $n$ -manifold

$$S_f = (x_1, x_2, \dots, x_n, y(x_1, x_2, \dots, x_n)) \subset \mathbb{R}^{n+1}$$

if it is solvable, otherwise  $\emptyset$  in topology. Clearly, a system

$$(ES_m) \begin{cases} f_1(x_1, x_2, \dots, x_n) = 0 \\ f_2(x_1, x_2, \dots, x_n) = 0 \\ \dots\dots\dots \\ f_m(x_1, x_2, \dots, x_n) = 0 \end{cases}$$

of algebraic equations with initial values  $f_i(0), 1 \leq i \leq m$  in Euclidean space  $\mathbb{R}^{n+1}$  is solvable or not dependent on  $\bigcap_{i=1}^m S_{f_i} \neq \emptyset$  or  $= \emptyset$  in geometry.

Particularly, let  $(PDES_m)$  be a system of partial differential equations with

$$\begin{cases} F_1(x_1, x_2, \dots, x_n, u, u_{x_1}, \dots, u_{x_n}, u_{x_1x_2}, \dots, u_{x_1x_n}, \dots) = 0 \\ F_2(x_1, x_2, \dots, x_n, u, u_{x_1}, \dots, u_{x_n}, u_{x_1x_2}, \dots, u_{x_1x_n}, \dots) = 0 \\ \dots\dots\dots \\ F_m(x_1, x_2, \dots, x_n, u, u_{x_1}, \dots, u_{x_n}, u_{x_1x_2}, \dots, u_{x_1x_n}, \dots) = 0 \end{cases}$$

on a function  $u(x_1, \dots, x_n, t)$ . Its *symbol* is determined by

$$\begin{cases} F_1(x_1, x_2, \dots, x_n, u, p_1, \dots, p_n, p_1p_2, \dots, p_1p_n, \dots) = 0 \\ F_2(x_1, x_2, \dots, x_n, u, p_1, \dots, p_n, p_1p_2, \dots, p_1p_n, \dots) = 0 \\ \dots\dots\dots \\ F_m(x_1, x_2, \dots, x_n, u, p_1, \dots, p_n, p_1p_2, \dots, p_1p_n, \dots) = 0, \end{cases}$$

i.e., substitute  $p_1^{\alpha_1} p_2^{\alpha_2} \dots p_n^{\alpha_n}$  into  $(PDES_m)$  for the term  $u_{x_1^{\alpha_1} x_2^{\alpha_2} \dots x_n^{\alpha_n}}$ , where  $\alpha_i \geq 0$  for integers  $1 \leq i \leq n$ .

**Definition 3.1** A non-solvable  $(PDES_m)$  is algebraically contradictory if its symbol is non-solvable. Otherwise, differentially contradictory.

For example, the system of partial differential equations following

$$\begin{cases} u_x + 2u_y + 3u_z = 2 + y^2 + z^2 \\ yz u_x + xz u_y + xy u_z = x^2 - y^2 - z^2 \\ (yz + 1)u_x + (xz + 2)u_y + (xy + 3)u_z = x^2 + 1 \end{cases}$$

is algebraically contradictory because its symbol

$$\begin{cases} p_1 + 2p_2 + 3p_3 = 2 + y^2 + z^2 \\ yz p_1 + xz p_2 + xy p_3 = x^2 - y^2 - z^2 \\ (yz + 1)p_1 + (xz + 2)p_2 + (xy + 3)p_3 = x^2 + 1 \end{cases}$$

is non-solvable. A necessary and sufficient condition on the solvability of Cauchy problem on  $(PDES_m)$  was found in [16] following.

**Theorem 3.2** *A Cauchy problem on systems*

$$\begin{cases} F_1(x_1, x_2, \dots, x_n, u, p_1, p_2, \dots, p_n) = 0 \\ F_2(x_1, x_2, \dots, x_n, u, p_1, p_2, \dots, p_n) = 0 \\ \dots\dots\dots \\ F_m(x_1, x_2, \dots, x_n, u, p_1, p_2, \dots, p_n) = 0 \end{cases} \quad (PDES_m)$$

of partial differential equations of first order is non-solvable with initial values

$$\begin{cases} x_i|_{x_n=x_n^0} = x_i^0(s_1, s_2, \dots, s_{n-1}) \\ u|_{x_n=x_n^0} = u_0(s_1, s_2, \dots, s_{n-1}) \\ p_i|_{x_n=x_n^0} = p_i^0(s_1, s_2, \dots, s_{n-1}), \quad i = 1, 2, \dots, n \end{cases}$$

if and only if the system

$$F_k(x_1, x_2, \dots, x_n, u, p_1, p_2, \dots, p_n) = 0, \quad 1 \leq k \leq m$$

is algebraically contradictory, in this case, there must be an integer  $k_0, 1 \leq k_0 \leq m$  such that

$$F_{k_0}(x_1^0, x_2^0, \dots, x_{n-1}^0, x_n^0, u_0, p_1^0, p_2^0, \dots, p_n^0) \neq 0$$

or it is differentially contradictory itself, i.e., there is an integer  $j_0, 1 \leq j_0 \leq n - 1$  such that

$$\frac{\partial u_0}{\partial s_{j_0}} - \sum_{i=0}^{n-1} p_i^0 \frac{\partial x_i^0}{\partial s_{j_0}} \neq 0.$$

Particularly, we immediately get a conclusions on quasilinear partial differential equations following.

**Corollary 3.3** *A Cauchy problem ( $PDES_m^C$ ) of quasilinear partial differential equations with initial values  $u|_{x_n=x_n^0} = u_0$  is non-solvable if and only if the system ( $PDES_m$ ) of partial differential equations is algebraically contradictory.*

Geometrically, the behavior of ( $ES_m$ ) is completely characterized by a union  $\bigcup_{i=1}^m S_{f_i}$ , i.e., a Smarandache multispace with an inherited graph  $G^L [ES_m]$  following:

$$V (G^L [ES_m]) = \{S_{f_i}, 1 \leq i \leq m\},$$

$$E (G^L [ES_m]) = \{ (S_{f_i}, S_{f_j}) \mid S_{f_i} \cap S_{f_j} \neq \emptyset, 1 \leq i, j \leq m \}$$

with a vertex and edge labeling

$$L : S_{f_i} \rightarrow S_{f_i} \text{ and } L : (S_{f_i}, S_{f_j}) \rightarrow S_{f_i} \cap S_{f_j} \text{ if}$$

for integers  $1 \leq i \leq m$  and  $(S_{f_i}, S_{f_j}) \in E (G^L [ES_m])$ .

For example, it is clear that  $L_{x+y=1} \cap L_{x+y=-1} = \emptyset = L_{x-y=1} \cap L_{x-y=-1} = \emptyset$ ,  $L_{x+y=1} \cap L_{x-y=-1} = \{A\}$ ,  $L_{x+y=1} \cap L_{x-y=1} = \{B\}$ ,  $L_{x+y=-1} \cap L_{x-y=1} = \{C\}$ ,  $L_{x+y=-1} \cap L_{x-y=-1} = \{D\}$  for the system ( $LES_4^N$ ) with an inherited graph  $C_4^L$  shown in Fig.14.

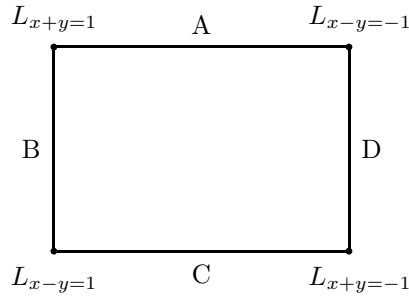

**Fig.14**

Generally, we can determine the graph  $G [\tilde{S}]$ . In fact, let  $\mathcal{C}(f_i)$  be a maximal contradictory class including equation  $f_i = 0$  in ( $ES_m$ ) for an integer  $1 \leq i \leq m$  and let classes  $\mathcal{C}^1, \mathcal{C}^2, \dots, \mathcal{C}^l$  be a partition of equations in ( $ES_m$ ). Then we easily know that

$$G [\tilde{S}] \simeq K (\mathcal{C}^1, \mathcal{C}^2, \dots, \mathcal{C}^l).$$

Particularly, a result on Cauchy problem of partial differential equations following.

**Theorem 3.4** ([16]) *A Cauchy problem on system ( $PDES_m$ ) of partial differential equations of first order with initial values  $x_i^{[k^0]}, u_0^{[k]}, p_i^{[k^0]}$ ,  $1 \leq i \leq n$  for the  $k$ th equation in ( $PDES_m$ ),  $1 \leq k \leq m$  such that*

$$\frac{\partial u_0^{[k]}}{\partial s_j} - \sum_{i=0}^n p_i^{[k^0]} \frac{\partial x_i^{[k^0]}}{\partial s_j} = 0$$

*is uniquely  $G$ -solvable, i.e.,  $G[PDES_m^C]$  is uniquely determined.*

### 3.2 Geometry on Action Flows

Let  $(\vec{G}; L, A)$  be an action flow on Banach space  $\mathcal{B}$ . By the closed graph theorem in functional analysis, i.e., if  $X$  and  $Y$  are Banach spaces with a linear operator  $\varphi : X \rightarrow Y$ , then  $\varphi$  is continuous if and only if its graph

$$\Gamma[X, Y] = \{(\bar{x}, \bar{y}) \in X \times Y \mid T\bar{x} = \bar{y}\}$$

is closed in  $X \times Y$ , if  $L(v, u) : \mathbb{R}^n \rightarrow \mathbb{R}^n$  is  $\mathbb{C}^r$  differentiable for  $\forall (v, u) \in E(\vec{G})$ , then

$$\Gamma[v, u] = \{((x_1, \dots, x_n), L(v, u)) \mid (x_1, \dots, x_n) \in \mathbb{R}^n\}$$

is a  $\mathbb{C}^{r_{vu}}$  differentiable  $n$ -dimensional manifold, where  $r_{vu} \geq 0$  is an integer. Whence, the geometry of action flow  $(\vec{G}; L, A)$  is nothing else but a combination of  $\mathbb{C}^{r_{vu}}$  differentiable manifolds for  $r_{vu} \geq 0, (v, u) \in E(\vec{G})$ , such as those combinatorial manifolds (a) and (b) shown in Fig.15 for  $r = 0$ .

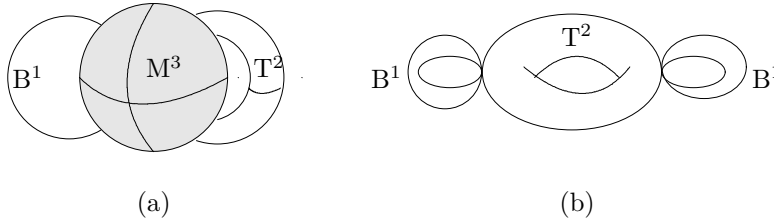

Fig.15

**Definition 3.5** For a given integer sequence  $0 < n_1 < n_2 < \dots < n_m, m \geq 1$ , a combinatorial manifold  $\widetilde{M}$  is a Hausdorff space such that for any point  $p \in \widetilde{M}$ , there is a local chart  $(U_p, \varphi_p)$  of  $p$ , i.e., an open neighborhood  $U_p$  of  $p$  in  $\widetilde{M}$  and a homeomorphism  $\varphi_p : U_p \rightarrow \widetilde{\mathbf{R}}(n_1(p), \dots, n_{s(p)}(p))$  with

$$\{n_1(p), \dots, n_{s(p)}(p)\} \subseteq \{n_1, \dots, n_m\}, \quad \bigcup_{p \in \widetilde{M}} \{n_1(p), \dots, n_{s(p)}(p)\} = \{n_1, \dots, n_m\},$$

denoted by  $\widetilde{M}(n_1, n_2, \dots, n_m)$  or  $\widetilde{M}$  on the context and

$$\widetilde{\mathcal{A}} = \left\{ (U_p, \varphi_p) \mid p \in \widetilde{M}(n_1, n_2, \dots, n_m) \right\}$$

its an atlas. Particularly, a combinatorial manifold  $\widetilde{M}$  is finite if it is just combined by finite manifolds without one manifold contained in the union of others.

Similarly, an inherent structure  $G^L[\widetilde{M}]$  on combinatorial manifolds  $\widetilde{M} = \bigcup_{i=1}^m M_i$  is defined



by

$$\begin{aligned} V(G^L[\widetilde{M}]) &= \{M_1, M_2, \dots, M_m\}, \\ E(G^L[\widetilde{M}]) &= \{(M_i, M_j) \mid M_i \cap M_j \neq \emptyset, 1 \leq i, j \leq m\} \end{aligned}$$

with a labeling mapping  $L$  determined by

$$L: M_i \rightarrow M_i, \quad L: (M_i, M_j) \rightarrow M_i \cap M_j$$

for integers  $1 \leq i, j \leq m$ . The result following enables one to construct  $\mathbb{C}^r$  differentiable combinatorial manifolds.

**Theorem 3.6**[8] *Let  $\widetilde{M}$  be a finitely combinatorial manifold. If  $\forall M \in V(G^L[\widetilde{M}])$  is  $C^r$ -differential for integer  $r \geq 0$  and  $\forall (M_1, M_2) \in E(G[\widetilde{M}])$  there exist atlas*

$$\mathcal{A}_1 = \{(V_x; \varphi_x) \mid \forall x \in M_1\} \quad \mathcal{A}_2 = \{(W_y; \psi_y) \mid \forall y \in M_2\}$$

such that  $\varphi_x|_{V_x \cap W_y} = \psi_y|_{V_x \cap W_y}$  for  $\forall x \in M_1, y \in M_2$ , then there is a differential structures

$$\widetilde{\mathcal{A}} = \{(U_p; [\varphi_p]) \mid \forall p \in \widetilde{M}\}$$

such that  $(\widetilde{M}; \widetilde{\mathcal{A}})$  is a combinatorial  $C^r$ -differential manifold.

For the basis of tangent and cotangent vectors on combinatorial manifold  $\widetilde{M}$ , we know results following in [8].

**Theorem 3.7** *For any point  $p \in \widetilde{M}(n_1, n_2, \dots, n_m)$  with a local chart  $(U_p; [\varphi_p])$ , the dimension of  $T_p \widetilde{M}(n_1, n_2, \dots, n_m)$  is*

$$\dim T_p \widetilde{M}(n_1, n_2, \dots, n_m) = \widehat{s}(p) + \sum_{i=1}^{s(p)} (n_i - \widehat{s}(p))$$

with a basis matrix  $\left[ \frac{\partial}{\partial x} \right]_{s(p) \times n_{s(p)}}$  =

$$\begin{bmatrix} \frac{1}{s(p)} \frac{\partial}{\partial x^{11}} & \cdots & \frac{1}{s(p)} \frac{\partial}{\partial x^{1s(p)}} & \frac{\partial}{\partial x^{1(s(p)+1)}} & \cdots & \frac{\partial}{\partial x^{1n_1}} & \cdots & 0 \\ \frac{1}{s(p)} \frac{\partial}{\partial x^{21}} & \cdots & \frac{1}{s(p)} \frac{\partial}{\partial x^{2s(p)}} & \frac{\partial}{\partial x^{2(s(p)+1)}} & \cdots & \frac{\partial}{\partial x^{2n_2}} & \cdots & 0 \\ \cdots & \cdots & \cdots & \cdots & \cdots & \cdots & \cdots & \cdots \\ \frac{1}{s(p)} \frac{\partial}{\partial x^{s(p)1}} & \cdots & \frac{1}{s(p)} \frac{\partial}{\partial x^{s(p)s(p)}} & \frac{\partial}{\partial x^{s(p)(s(p)+1)}} & \cdots & \cdots & \frac{\partial}{\partial x^{s(p)(n_{s(p)}-1)}} & \frac{\partial}{\partial x^{s(p)n_{s(p)}}} \end{bmatrix}$$

where  $x^{il} = x^{jl}$  for  $1 \leq i, j \leq s(p), 1 \leq l \leq \widehat{s}(p)$ , namely there is a smoothly functional matrix  $[v_{ij}]_{s(p) \times n_{s(p)}}$  such that for any tangent vector  $\bar{v}$  at a point  $p$  of  $\widetilde{M}(n_1, n_2, \dots, n_m)$ ,

$$\bar{v} = \left\langle [v_{ij}]_{s(p) \times n_{s(p)}}, \left[ \frac{\partial}{\partial x} \right]_{s(p) \times n_{s(p)}} \right\rangle,$$

where  $\langle [a_{ij}]_{k \times l}, [b_{ts}]_{k \times l} \rangle = \sum_{i=1}^k \sum_{j=1}^l a_{ij} b_{ij}$ , the inner product on matrixes.

**Theorem 3.8** For  $\forall p \in (\widetilde{M}(n_1, n_2, \dots, n_m); \widetilde{A})$  with a local chart  $(U_p; [\varphi_p])$ , the dimension of  $T_p^* \widetilde{M}(n_1, n_2, \dots, n_m)$  is

$$\dim T_p^* \widetilde{M}(n_1, n_2, \dots, n_m) = \widehat{s}(p) + \sum_{i=1}^{s(p)} (n_i - \widehat{s}(p))$$

with a basis matrix  $[d\overline{x}]_{s(p) \times n_{s(p)}} =$

$$\begin{bmatrix} \frac{dx^{11}}{s(p)} & \dots & \frac{dx^{1\widehat{s}(p)}}{s(p)} & dx^{1(\widehat{s}(p)+1)} & \dots & dx^{1n_1} & \dots & 0 \\ \frac{dx^{21}}{s(p)} & \dots & \frac{dx^{2\widehat{s}(p)}}{s(p)} & dx^{2(\widehat{s}(p)+1)} & \dots & dx^{2n_2} & \dots & 0 \\ \dots & \dots & \dots & \dots & \dots & \dots & \dots & \dots \\ \frac{dx^{s(p)1}}{s(p)} & \dots & \frac{dx^{s(p)\widehat{s}(p)}}{s(p)} & dx^{s(p)(\widehat{s}(p)+1)} & \dots & \dots & dx^{s(p)n_{s(p)}-1} & dx^{s(p)n_{s(p)}} \end{bmatrix}$$

where  $x^{il} = x^{jl}$  for  $1 \leq i, j \leq s(p), 1 \leq l \leq \widehat{s}(p)$ , namely for any co-tangent vector  $d$  at a point  $p$  of  $\widetilde{M}(n_1, n_2, \dots, n_m)$ , there is a smoothly functional matrix  $[u_{ij}]_{s(p) \times s(p)}$  such that,

$$d = \left\langle [u_{ij}]_{s(p) \times s(p)}, [d\overline{x}]_{s(p) \times n_{s(p)}} \right\rangle.$$

Then, we can establish tensor theory with connections on smoothly combinatorial manifolds ([8]) and [11]. For example, we can get the curvature  $\widetilde{R}$  formula following.

**Theorem 3.9** ([8]) Let  $\widetilde{M}$  be a finite combinatorial manifold,  $\widetilde{R} : \mathcal{X}(\widetilde{M}) \times \mathcal{X}(\widetilde{M}) \times \mathcal{X}(\widetilde{M}) \times \mathcal{X}(\widetilde{M}) \rightarrow C^\infty(\widetilde{M})$  a curvature on  $\widetilde{M}$ . Then for  $\forall p \in \widetilde{M}$  with a local chart  $(U_p; [\varphi_p])$ ,

$$\widetilde{R} = \widetilde{R}_{(\sigma\varsigma)(\eta\theta)(\mu\nu)(\kappa\lambda)} dx^{\sigma\varsigma} \otimes dx^{\eta\theta} \otimes dx^{\mu\nu} \otimes dx^{\kappa\lambda},$$

where

$$\begin{aligned} \widetilde{R}_{(\sigma\varsigma)(\eta\theta)(\mu\nu)(\kappa\lambda)} &= \frac{1}{2} \left( \frac{\partial^2 g_{(\mu\nu)(\sigma\varsigma)}}{\partial x^{\kappa\lambda} \partial x^{\eta\theta}} + \frac{\partial^2 g_{(\kappa\lambda)(\eta\theta)}}{\partial x^{\mu\nu} \partial x^{\sigma\varsigma}} - \frac{\partial^2 g_{(\mu\nu)(\eta\theta)}}{\partial x^{\kappa\lambda} \partial x^{\sigma\varsigma}} - \frac{\partial^2 g_{(\kappa\lambda)(\sigma\varsigma)}}{\partial x^{\mu\nu} \partial x^{\eta\theta}} \right) \\ &+ \Gamma_{(\mu\nu)(\sigma\varsigma)}^{\vartheta\iota} \Gamma_{(\kappa\lambda)(\eta\theta)}^{\xi\omicron} g_{(\xi\omicron)(\vartheta\iota)} - \Gamma_{(\mu\nu)(\eta\theta)}^{\xi\omicron} \Gamma_{(\kappa\lambda)(\sigma\varsigma)\vartheta\iota} g_{(\xi\omicron)(\vartheta\iota)}, \end{aligned}$$

and  $g_{(\mu\nu)(\kappa\lambda)} = g\left(\frac{\partial}{\partial x^{\mu\nu}}, \frac{\partial}{\partial x^{\kappa\lambda}}\right)$ .

All these results on differentiable combinatorial manifolds enable one to characterize the combination of classical fields, such as the Einstein's gravitational fields and other fields on combinatorial spacetimes and hold their behaviors (see [10] for details).

### 3.3 Classification

**Definition 3.10** Let  $(\vec{G}_1; L_1, A_1)$  and  $(\vec{G}_2; L_2, A_2)$  be 2 action flows on Banach space  $\mathcal{B}$  with  $\vec{G}_1 \simeq \vec{G}_2$ . Then they are said to be combinatorially homeomorphic if there is a homeomorphism  $h$  on  $\mathcal{B}$  and a 1-1 mapping  $\varphi : V(\vec{G}_1) \rightarrow V(\vec{G}_2)$  such that  $h(L_1(v, u)) = L_2(\varphi(v, u))$  and

$A_{vu} = A_{\varphi(vu)}$  for  $\forall(v, u) \in V(\vec{G}_1)$ , denoted by  $(\vec{G}_1; L_1, A_1) \stackrel{h}{\sim} (\vec{G}_2; L_2, A_2)$ . Particularly, if  $\mathcal{B} = \mathbb{R}^n$  for an integer  $n \geq 3$ ,  $h$  is an isometry, they are said to be combinatorially isometric, denoted by  $(\vec{G}_1; L_1, A_1) \stackrel{h}{\simeq} (\vec{G}_2; L_2, A_2)$ , and identical if  $h = \mathbf{1}_{\mathbb{R}^n}$ , denoted by  $(\vec{G}_1; L_1, A_1) = (\vec{G}_2; L_2, A_2)$ .

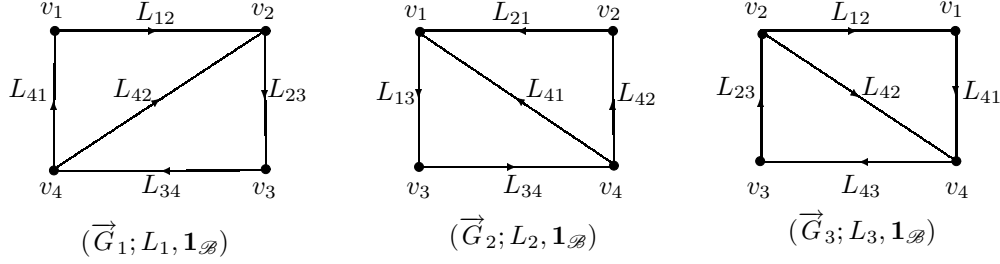

Fig.16

Notice that the mapping  $\varphi$  in Definition 3.10 maybe not a graph isomorphism. For example, the action flows  $(\vec{G}_1; L_1, \mathbf{1}_{\mathbb{R}^n}) = (\vec{G}_2; L_2, \mathbf{1}_{\mathbb{R}^n})$  because there is a 1-1 mapping  $\varphi = (v_1 v_2)(v_3)(v_4) : V(\vec{G}_1) \rightarrow V(\vec{G}_2)$  holding with  $L(u, v) = L(\varphi(u, v))$  for  $\forall(u, v) \in E(\vec{G})$ , which is not a graph isomorphism between  $\vec{G}_1$  and  $\vec{G}_2$  but  $(\vec{G}_1; L_1, \mathbf{1}_{\mathbb{R}^n}) \neq (\vec{G}_3; L_3, \mathbf{1}_{\mathbb{R}^n})$  for  $\vec{G}_1 \not\cong \vec{G}_3$  in Fig.16. Thus if we denote by  $\text{Aut}(\vec{G}; L, A)$  all such 1-1 mappings  $\varphi : V(\vec{G}) \rightarrow V(\vec{G})$  holding with  $L(u, v) = L(\varphi(u, v))$  and  $A_{uv} = A_{\varphi(uv)}$  for  $\forall(u, v) \in E(\vec{G})$ , then it is clearly a group itself holding with the following result.

**Theorem 3.11** *If  $V(\vec{G}) = \{v_1, v_2, \dots, v_p\}$ , then  $\text{Aut}(\vec{G}; L, A) = \text{Aut} \vec{G} \otimes (S_p)_{\vec{G}}$ , particularly,  $\text{Aut}(\vec{G}; L, A) \succ \text{Aut} \vec{G}$ , where  $(S_p)_{\vec{G}}$  is the stabilizer of symmetric group  $S_p$  on  $\Delta = \{1, 2, \dots, p\}$ .*

For an isometry  $h$  on  $\mathbb{R}^n$ , let  $(\vec{G}; L, A)^h = (\vec{G}; hLh^{-1}, A)$  be an action flow, i.e., replacing  $x_1, x_2, \dots, x_n$  by  $h(x_1), h(x_2), \dots, h(x_n)$ . The result following is clearly known by definition.

**Theorem 3.12**  $(\vec{G}_1; L_1, A_1) \stackrel{h}{\simeq} (\vec{G}_2; L_2, A_2)$  if and only if  $(\vec{G}_1; L_1, A_1)^h = (\vec{G}_2; L_2, A_2)$ .

Certainly, we can also classify action flows geometrically. For example, two finitely combinatorial manifolds  $\widetilde{M}_1, \widetilde{M}_2$  are said to be *homotopically equivalent* if there exist continuous mappings  $f : \widetilde{M}_1 \rightarrow \widetilde{M}_2$  and  $g : \widetilde{M}_2 \rightarrow \widetilde{M}_1$  such that  $gf \simeq \text{identity} : \widetilde{M}_2 \rightarrow \widetilde{M}_2$  and  $fg \simeq \text{identity} : \widetilde{M}_1 \rightarrow \widetilde{M}_1$ . Then we know

**Theorem 3.13**([7]) *Let  $\widetilde{M}_1$  and  $\widetilde{M}_2$  be finitely combinatorial manifolds with an equivalence  $\varpi : G^L[\widetilde{M}_1] \rightarrow G^L[\widetilde{M}_2]$ . If for  $\forall M_i, M_j \in V(G^L[\widetilde{M}_1])$ ,  $M_i$  is homotopic to  $\varpi(M_i)$  with homotopic mappings  $f_{M_i} : M_i \rightarrow \varpi(M_i)$ ,  $g_{M_i} : \varpi(M_i) \rightarrow M_i$  such that  $f_{M_i}|_{M_i \cap M_j} = f_{M_j}|_{M_i \cap M_j}$ ,  $g_{M_i}|_{M_i \cap M_j} = g_{M_j}|_{M_i \cap M_j}$  providing  $(M_i, M_j) \in E(G^L[\widetilde{M}_1])$  for  $1 \leq i, j \leq m$ , then  $\widetilde{M}_1$  is homotopic to  $\widetilde{M}_2$ .*

#### §4. Stable Action Flows

The importance of stability for a model on natural things  $P$  results in determining the prediction and controlling of its behaviors. The same also happens to those of action flows for the perturbation of things such as those shown in Fig.17 on operating of the universe.

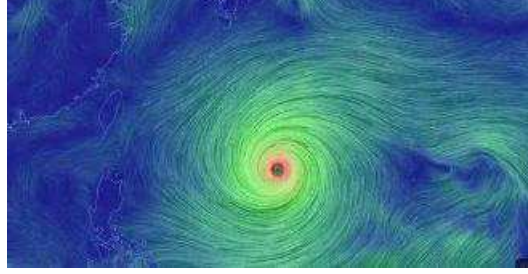

Fig.17

As we shown in Theorem 3.4, the Cauchy problem on partial differential equations of first order is uniquely  $G$ -solvable. Thus it is significant to consider the stability of action flows. Let  $(\vec{G}; L(t), A)$  be an action flow on Banach space  $\mathcal{B}$  with initial values  $(\vec{G}; L(t_0), A)$  and let  $\omega : (\vec{G}; L, A) \rightarrow \mathbb{R}$  be an index function. It is said to be  $\omega$ -stable if there exists a number  $\delta(\varepsilon)$  for any number  $\varepsilon > 0$  such that

$$\left\| \omega \left( \vec{G}; L_1(t) - L_2(t), A \right) \right\| < \varepsilon,$$

or furthermore, *asymptotically*  $\omega$ -stable if

$$\lim_{t \rightarrow \infty} \left\| \omega \left( \vec{G}; L_1(t) - L_2(t), A \right) \right\| = 0$$

if initial values holding with

$$\|L_1(t_0)(v, u) - L_2(t_0)(v, u)\| < \delta(\varepsilon)$$

for  $\forall (v, u) \in E(\vec{G})$ , for instance the *norm-stable* or *sum-stable* by letting

$$\omega \left( \vec{G}; L, A \right) = \sum_{(v, u) \in E(\vec{G})} \left\| L^{A_{vu}^+}(v, u) \right\|.$$

Particularly, let

$$\omega \left( \vec{G}; L, \mathbf{1}_{\mathcal{B}} \right) = \sum_{(v, u) \in E(\vec{G})} \|L(v, u)\|$$

or

$$\left( \vec{G}; L, A \right) = \left\| \sum_{(v, u) \in E(\vec{G})} L(v, u) \right\|, \quad A \neq \mathbf{1}_{\mathcal{B}}.$$

The following result on the stability of  $\vec{G}$ -flow solution was obtained in [17], which is a

commonly norm-stability on  $\vec{G}$ -flows.

**Theorem 4.1** *Let  $\mathcal{V}$  be the Hilbert space  $L^2[\Delta]$ . Then, the  $\vec{G}$ -flow solution  $X$  of equation*

$$\begin{cases} \mathcal{F}(\mathbf{x}, X, X_{x_1}, \dots, X_{x_n}, X_{x_1 x_2}, \dots) = 0 \\ X|_{\mathbf{x}_0} = \vec{G}^L \end{cases}$$

in  $\vec{G}^{\mathcal{V}}$  is norm-stable if and only if the solution  $u(\mathbf{x})$  of equation

$$\begin{cases} \mathcal{F}(\mathbf{x}, u, u_{x_1}, \dots, u_{x_n}, u_{x_1 x_2}, \dots) = 0 \\ u|_{\mathbf{x}_0} = \varphi(\mathbf{x}) \end{cases}$$

on  $(v, u)$  is stable for  $\forall (v, u) \in E(\vec{G})$ .

In fact, we only need to consider the stability of  $(\vec{G}; \mathbf{O}, A)$  after letting flows  $\mathbf{O} = L(t)(v, u) - L(t)(v, u)$  on  $\forall (v, u) \in E(\vec{G})$  without loss of generality.

Similarly, if there is a Liapunov  $\omega$ -function  $L(\omega(t)) : \mathcal{O} \rightarrow \mathbb{R}, n \geq 1$  on  $\vec{G}$  with  $\mathcal{O} \subset \mathbb{R}^n$  open such that  $L(\omega(t)) \geq 0$  with equality hold only if  $(x_1, x_2, \dots, x_n) = (0, 0, \dots, 0)$  and if  $t \geq t_0, \dot{L}(\omega(t)) \leq 0$ , then it can be likewise Theorem 3.8 of [12] to know the next result, where  $\dot{L}(\omega) = \frac{dL(\omega)}{dt}$ .

**Theorem 4.2** *If there is a Liapunov  $\omega$ -function  $L(\omega(t)) : \mathcal{O} \rightarrow \mathbf{R}$  on  $\vec{G}$ , then  $(\vec{G}; \mathbf{O}, A)$  is  $\omega$ -stable, and furthermore, if  $\dot{L}(\omega(t)) < 0$  for  $(\vec{G}; L(t), A) \neq \mathbf{O}$ , then  $(\vec{G}; \mathbf{O}, A)$  is asymptotically  $\omega$ -stable.*

For example, let  $(\vec{G}; L, A)$  be the action flow with operators  $A_{z_{i+1}z_i} = -\frac{d}{dt}$  for  $z = v, u, \dots, w$  and  $A_{v_i v_{i+1}}^+ = \lambda_{1i}, A_{u_i u_{i+1}}^+ = \lambda_{2i}, \dots, A_{w_i w_{i+1}}^+ = \lambda_{ni}$  for integer  $i \equiv (\text{mod } n)$ , such as those shown in Fig.18.

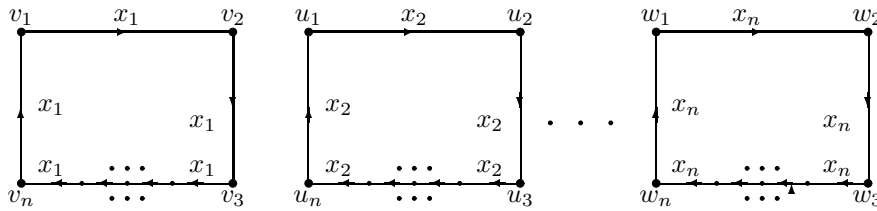

Fig.18

Then its conservation equations are respectively

$$\left\{ \begin{array}{l} \dot{x}_1 = \lambda_{11}x_1 \\ \dot{x}_1 = \lambda_{12}x_1 \\ \dots\dots\dots \\ \dot{x}_1 = \lambda_{1n}x_1 \end{array} \right. , \left\{ \begin{array}{l} \dot{x}_2 = \lambda_{21}x_2 \\ \dot{x}_2 = \lambda_{22}x_2 \\ \dots\dots\dots \\ \dot{x}_2 = \lambda_{2n}x_2 \end{array} \right. , \dots , \left\{ \begin{array}{l} \dot{x}_n = \lambda_{n1}x_n \\ \dot{x}_n = \lambda_{n2}x_n \\ \dots\dots\dots \\ \dot{x}_n = \lambda_{nn}x_n \end{array} \right. ,$$

where all  $\lambda_{ij}$ ,  $1 \leq i, j \leq n$  are real and  $\lambda_{ij_1} \neq \lambda_{ij_2}$  if  $j_1 \neq j_2$  for integers  $1 \leq i \leq n$ . Let  $L = x_1^2 + x_2^2 + \dots + x_n^2$ . Then  $\dot{L} = \lambda_{i_1}x_1^2 + \lambda_{i_2}x_2^2 + \dots + \lambda_{i_n}x_n^2$  for integers  $1 \leq i \leq n$ , where  $1 \leq i_j \leq n$  for integers  $1 \leq j \leq n$ . Whence, it is a Liapunov  $\omega$ -function for action flow  $(\vec{G}; L, A)$  if  $\lambda_{ij} < 0$  for integers  $1 \leq i, j \leq n$ .

**§5. Applications**

As a powerful theory, action flow extends classical mathematics on embedded graph, which can be used as a model nearly for moving things in the nature, particularly, applying to physics and mathematical ecology.

**5.1 Physics**

For diversity of things, two typical examples are respectively the superposition behavior of microcosmic particle and the quarks model of Sakata, or Gell-Mann and Ne’eman by assuming internal structures of hadrons and gluons, which can not be commonly understanding.

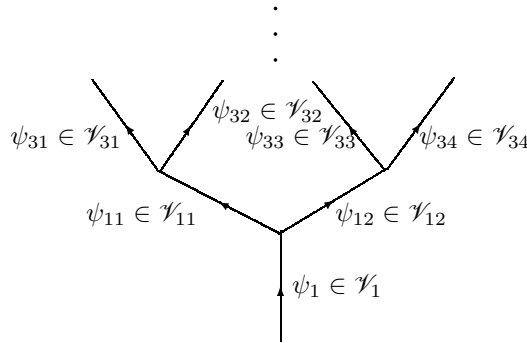

**Fig.19**

Certainly, H.Everett’s multiverse interpretation in Fig.6 presented the superposition of particles but with a little machinery, i.e., viewed different worlds in different quantum mechanics and explained the superposition of a particle to be 2 branch tree such as those shown in Fig.19, where the multiverse is  $\bigcup_{i \geq 1} V_i$  with  $V_{kl} = V$  for integers  $k \geq 1, 1 \leq l \leq 2^k$  but in different positions.

Similarly, the quark model assumes internal structures  $K_2, K_3$  respectively on hadrons and gluons mechanically for hold the behaviors of particles. However, such an assumption is a little ambiguous in logic, i.e., we can not even conclude which is the point, the hadron and gluon or its subparticle, the quark. However, the action flows imply the rightness of H.Everett’s

multiverse interpretation, also the assumption of physicists on the internal structures for hold the behaviors of particles because there are infinite many such graphs  $\vec{G}$  satisfying conditions of Theorem 2.9.

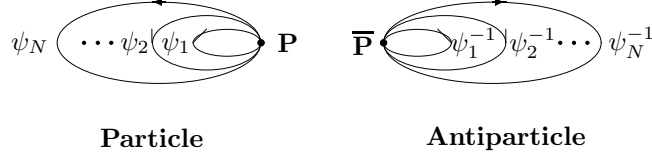

Fig.20

For example, let  $\vec{G} = \vec{B}_n$  or  $\vec{D}_{0,2N,0}^\perp$ , i.e., a bouquet or a dipole. Then we can respectively establish a  $\vec{G}$ -flow model for fermions, leptons, quark  $P$  with an antiparticle  $\bar{P}$ , and the mediate interaction particles presented in Banach space  $\vec{B}_N^\psi$  or  $\vec{D}_{0,2N,0}^{\perp\psi}$ , such as those shown in Figs.20 and 21,

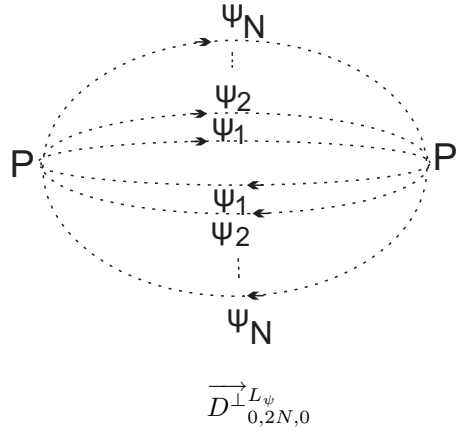

Fig.21

where, the vertex  $P, P'$  denotes particles, and arcs or loops with state functions  $\psi_1, \psi_2, \dots, \psi_N$  are its states with inverse functions  $\psi_1^{-1}, \psi_2^{-1}, \dots, \psi_N^{-1}$ . Notice that  $\vec{B}_N^{L\psi}$  and  $\vec{D}_{0,2N,0}^{\perp L\psi}$  both are a union of  $N$  circuits. We know the following result.

**Theorem 5.1**([18]) *For any integer  $N \geq 1$ , there are indeed  $\vec{D}_{0,2N,0}^{\perp L\psi}$ -flow solution on Klein-Gordon equation (3.5), and  $\vec{B}_N^{L\psi}$ -flow solution on Dirac equation (3.6).*

For a particle  $\tilde{P}$  consisted of  $l$  elementary particles  $P_1, P_1, \dots, P_l$  underlying a graph  $\vec{G}[\tilde{P}]$ , its  $\vec{G}$ -flow is obtained by replace vertices  $v$  by  $\vec{B}_N^{L\psi_v}$  and arcs  $e$  by  $\vec{D}_{0,2N_e,0}^{\perp L\psi_e}$  in  $\vec{G}[\tilde{P}]$ , denoted by  $\vec{G}^{L\psi}[\vec{B}_v, \vec{D}_e]$ . Then we know that

**Theorem 5.2**([18]) *If  $\tilde{P}$  is a particle consisted of elementary particles  $P_1, P_2, \dots, P_l$ , then  $\vec{G}^{L\psi}[\vec{B}_v, \vec{D}_e]$  is a  $\vec{G}$ -flow solution on the Schrödinger equation (1.1) whenever its size index*

$\lambda_G$  is finite or infinite, where

$$\lambda_G = \sum_{v \in V(\vec{G})} N_v + \sum_{e \in V(\vec{G})} N_e.$$

### 5.2 Mathematical Ecology

Action flows can be applied to be a model of ecological systems. For example, let  $u$  and  $v$  denote respectively the density of two species that compete for a common food supply. Then the equations of growth of the two populations may be characterized by ([6])

$$\begin{cases} \dot{u} = M(u, v)u \\ \dot{v} = N(u, v)v \end{cases} \quad (5.1)$$

particularly, the Lotka-Volterra competition model is given by

$$\begin{cases} \dot{u} = a_1u(1 - u/K_1 - \alpha_{12}v/K_1) \\ \dot{v} = a_2v(1 - v/K_2 - \alpha_{21}u/K_2) \end{cases} \quad (5.2)$$

in ordinary differentials ([21]), or

$$\begin{cases} u_t = d_1\Delta u + a_1u(1 - K_1u - \alpha_{12}v/K_1) \\ v_t = d_2\Delta v + a_2v(1 - K_2u - \alpha_{21}v/K_2) \end{cases} \quad (5.3)$$

in partial differentials on a boundary domain  $\Omega \subset \mathbb{R}^n$  for an integer  $n \geq 1$  with initial conditions  $\frac{\partial u}{\partial \nu} = \frac{\partial v}{\partial \nu} = 0$  on unit normal out vector  $\nu$ ,  $u(x, 0) = u_0(x)$ ,  $v(x, 0) = v_0(x)$  ([28]), where  $u(x, t), v(x, t)$  are respectively the density of 2 competitive species at  $(x, t) \in \Omega \times (0, \infty)$ ,  $M, N$  and positive parameters  $a_1, a_2$  are the growth rates,  $K_1, K_2$  are the carrying capacities,  $\alpha_{ij}$  denotes the interaction between the two species, i.e., the effect of species  $i$  on species  $j$  for  $i, j = 1$  or  $2$ , and  $d_1, d_2$  are the diffusion rate of species 1 and 2, respectively. This system is nothing else but an action flow on loop  $B_1$  on a boundary domain  $\Omega \subset \mathbb{R}^n$  for an integer  $n \geq 1$

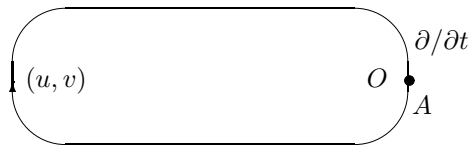

**Fig.22**

with initial conditions  $\frac{\partial u}{\partial \nu} = \frac{\partial v}{\partial \nu} = 0$  on unit normal out vector  $\nu$  and  $u(x, 0) = u_0(x)$ ,  $v(x, 0) = v_0(x)$  for  $(x, t) \in \Omega \times (0, \infty)$  such as those shown in Fig.22, where  $A(u, v) = (uM(u, v), vN(u, v))$ . For example,  $M(u, v) = a_1(1 - u/K_1 - \alpha_{12}v/K_1)$ ,  $N(u, v) = a_2(1 - v/K_2 - \alpha_{21}u/K_2)$  in equations (5.2) or  $M(u, v) = d_1\Delta u/u + a_1(1 - K_1u - \alpha_{12}v/K_1)$ ,  $N(u, v) = d_2\Delta v/v + a_2(1 -$



$K_2u - \alpha_{21}v/K_2$ ) in equations (5.3) for  $\forall(x, t) \in \Omega \times (0, \infty)$ .

Similarly, assume there are four kind groups in persons at time  $t$ , i.e., susceptible  $S(t)$ , infected but in the incubation period  $E(t)$ , infected with infectious  $I(t)$  and recovered  $R(t)$  and new recognition  $\Lambda$  with removal rates  $\kappa, \alpha$ , contact rate  $\beta$  and natural mortality rate  $\mu$ , such as the action flow shown in Fig.23.

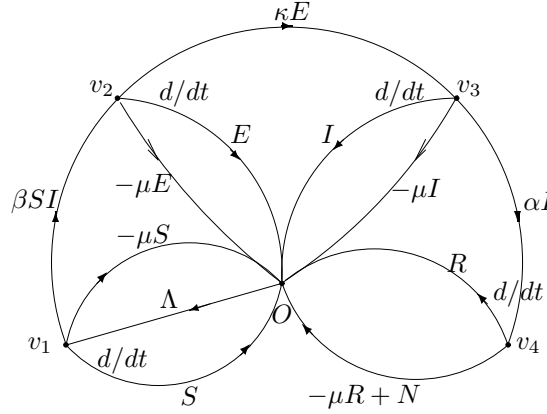

Fig.23

Then, we are easily to get the SEIR model on infectious by conservative laws respectively at vertices  $v_1, v_2, v_3$  and  $v_4$  following:

$$\begin{cases} \dot{S} = \Lambda - \mu S - \beta SI \\ \dot{E} = \beta SI - (\mu + \kappa)E \\ \dot{I} = \kappa E - (\mu + \alpha)I \\ \dot{R} = \alpha I - \mu R \end{cases} \quad (5.4)$$

where,  $N = S + R + E + I - \mu(S + R + E + I)$  and all end-operators are  $\mathbf{1}$  if it is not labeled in Fig.23. Notice that the systems (5.1)-(5.4) of differential equations are solvable. Whence, the behavior of action flows in Figs.22 and 23 can be characterized respectively by solution of system (5.1)-(5.4).

Generally, an ecological system is such an action flow  $(\vec{G}; L, A)$  on an oriented graph with a loop on its each vertex, where flows on loops and other edges denote respectively the density of species or interactions of one species action on another. If the conservation laws of an action flow are not solvable, then holding on the reality of competitive species by solution of equations will be not suitable again.

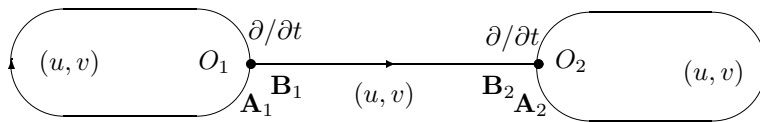

Fig.24

For example, the action flow shown in Fig.24 is such an ecological system with conservation laws

$$\begin{cases} (u_t, v_t) = \mathbf{A}_1(u, v) + \mathbf{B}_1(u, v) \\ (u_t, v_t) = \mathbf{A}_2(u, v) + \mathbf{B}_2(u, v) \end{cases}$$

under initial conditions  $\frac{\partial u}{\partial \nu} = \frac{\partial v}{\partial \nu} = 0$ ,  $u(x, 0) = u_0(x)$ ,  $v(x, 0) = v_0(x)$  for  $(x, t) \in \Omega \times (0, \infty)$ , where

$$\begin{aligned} \mathbf{A}_1(u, v) &= (d_1 \Delta u + a_1 u(1 - K_1 u - \alpha_{12} v / K_1), d_2 \Delta v + a_2 v(1 - K_2 u - \alpha_{21} v / K_2)) \\ \mathbf{A}_2(u, v) &= (d_3 \Delta u + a_3 u(1 - K_3 u - \alpha_{34} v / K_3), d_4 \Delta v + a_4 v(1 - K_4 u - \alpha_{43} v / K_4)) \\ \mathbf{B}_1(u, v) &= (U_1(u, v), V_1(u, v)), \quad \mathbf{B}_2(u, v) = (U_2(u, v), V_2(u, v)) \end{aligned}$$

for  $\forall(x, t) \in \Omega \times (0, \infty)$  and  $U_1, U_2, V_1, V_2$  are known functions. They are non-solvable in general but we can characterize its behaviors, for instance, the global stability by application of Theorem 4.2.

In fact, all ecological systems are interaction fields in physics. Let  $\mathcal{C}_1, \mathcal{C}_2, \dots, \mathcal{C}_m$  be  $m$  interaction fields with respective Hamiltonians  $H^{[1]}, H^{[2]}, \dots, H^{[m]}$ , where

$$H^{[k]} : (q_1, \dots, q_n, p_2, \dots, p_n, t) \rightarrow H^{[k]}(q_1, \dots, q_n, p_1, \dots, p_n, t)$$

for integers  $1 \leq k \leq m$ , i.e.,

$$\left. \begin{aligned} \frac{\partial H^{[k]}}{\partial p_i} &= \frac{dq_i}{dt} \\ \frac{\partial H^{[k]}}{\partial q_i} &= -\frac{dp_i}{dt}, \quad 1 \leq i \leq n \end{aligned} \right\} 1 \leq k \leq m.$$

Such a system is equivalent to the Cauchy problem on the system of partial differential equations

$$\left. \begin{aligned} \frac{\partial u}{\partial t} &= H_k(t, x_1, \dots, x_{n-1}, p_1, \dots, p_{n-1}) \\ u|_{t=t_0} &= u_0^{[k]}(x_1, x_2, \dots, x_{n-1}) \end{aligned} \right\} 1 \leq k \leq m. \quad (PDES_m)$$

and is in fact an action flows on  $m$  dipoles  $\vec{D}_{0,2,0}$ . For example, a system of interaction field is shown in Fig.25 in  $m = 4$  with  $A = A' = \frac{\partial}{\partial t}$  and  $A_1 = A_1 = 1$ .

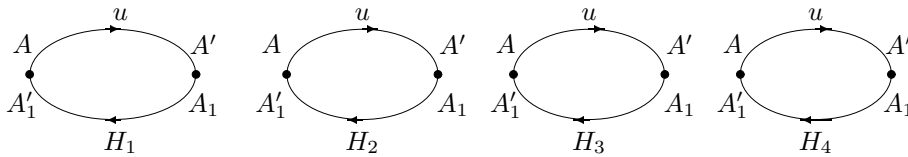

Fig.25

By choosing Liapunov sum-function  $L(\omega(t))(X) = \sum_{i=1}^m H_i(X)$  on  $\vec{G}$  in Theorem 3.15, the following result was obtained in [16] on the stability of system  $(PDES_m)$ .

**Theorem 5.3** Let  $X_0^{[i]}$  be an equilibrium point of the  $i$ th equation in  $(PDES_m)$  for each integer  $1 \leq i \leq m$ . If  $\sum_{i=1}^m H_i(X) > 0$  and  $\sum_{i=1}^m \frac{\partial H_i}{\partial t} \leq 0$  for  $X \neq \sum_{i=1}^m X_0^{[i]}$ , then the system  $(PDES_m)$  is sum-stability, i.e.,  $G[t] \xrightarrow{\Sigma} G[0]$ . Furthermore, if  $\sum_{i=1}^m \frac{\partial H_i}{\partial t} < 0$  for  $X \neq \sum_{i=1}^m X_0^{[i]}$ , then  $G[t] \xrightarrow{\Sigma} G[0]$ .

## §6. Conclusion

The main function of mathematics is provide quantitative analysis tools or ways for holding on the reality of things by observing from a macro or micro view. In fact, the out or macro observation is basic but the in-observation is cardinal, and an in-observation characterizes the individual behavior of things but with non-solvable equations in mathematics. However, the trend of mathematical developing in 20th century shows that a mathematical system is more concise, its conclusion is more extended, but farther to the true face of the natural things. *Is a mathematical true inevitable lead to the natural reality of a thing?* Certainly not because more characters of thing  $P$  have been abandoned in its mathematical model. Then, *is there a mathematical envelope theory on classical mathematics reflecting the nature of things?* Answer this question motivates the *mathematical combinatorics*, i.e., extending mathematical systems on topological graphs  $\vec{G}$  because the reality of things is nothing else but a multiverse on a topological structure under action, i.e., *action flows*, which is an appropriated way for understanding the nature because things are in connection, also with contradiction.

## References

- [1] R.Abraham and J.E.Marsden, *Foundation of Mechanics* (2nd edition), Addison-Wesley, Reading, Mass, 1978.
- [2] John B.Conway, *A Course in Functional Analysis*, Springer-Verlag New York,Inc., 1990.
- [3] M.Carmeli, *Classical Fields–General Relativity and Gauge Theory*, World Scientific, 2001.
- [4] Fritz John, *Partial Differential Equations*, New York, USA: Springer-Verlag, 1982.
- [5] H.Everett, Relative state formulation of quantum mechanics, *Rev.Mod.Phys.*, 29(1957), 454-462.
- [6] Morris W.Hirsch, Stephen Smale and Robert L.Devaney, *Differential Equations, Dynamical Systems & An introduction to Chaos* (Second Edition), Elsevier (Singapore) Pte Ltd, 2006.
- [7] Linfan Mao, Combinatorial speculation and combinatorial conjecture for mathematics, *International J.Math. Combin.* Vol.1(2007), No.1, 1-19.
- [8] Linfan Mao, Geometrical theory on combinatorial manifolds, *JP J.Geometry and Topology*, Vol.7, No.1(2007),65-114.
- [9] Linfan Mao, Combinatorial fields-an introduction, *International J. Math. Combin.*, Vol.1(2009), Vol.3, 1-22.
- [10] Linfan Mao, Relativity in combinatorial gravitational fields, *Progress in Physics*, Vol.3(2010), 39-50.

- [11] Linfan Mao, *Combinatorial Geometry with Applications to Field Theory*, The Education Publisher Inc., USA, 2011.
- [12] Linfan Mao, Global stability of non-solvable ordinary differential equations with applications, *International J.Math. Combin.*, Vol.1 (2013), 1-37.
- [13] Linfan Mao, Non-solvable equation systems with graphs embedded in  $\mathbf{R}^n$ , *Proceedings of the First International Conference on Smarandache Multispace and Multistructure*, The Education Publisher Inc. July, 2013
- [14] Linfan Mao, Geometry on  $G^L$ -systems of homogenous polynomials, *International J.Contemp. Math. Sciences*, Vol.9 (2014), No.6, 287-308.
- [15] Linfan Mao, Mathematics on non-mathematics - A combinatorial contribution, *International J.Math. Combin.*, Vol.3(2014), 1-34.
- [16] Linfan Mao, Cauchy problem on non-solvable system of first order partial differential equations with applications, *Methods and Applications of Analysis*, Vol.22, 2(2015), 171-200.
- [17] Linfan Mao, Extended Banach  $\vec{G}$ -flow spaces on differential equations with applications, *Electronic J.Mathematical Analysis and Applications*, Vol.3, No.2 (2015), 59-91.
- [18] Linfan Mao, A new understanding of particles by  $\vec{G}$ -flow interpretation of differential equation, *Progress in Physics*, Vol.11(2015), 193-201.
- [19] Linfan Mao, A review on natural reality with physical equation, *Progress in Physics*, Vol.11(2015), 276-282.
- [20] Linfan Mao, Mathematics after CC conjecture – combinatorial notions and achievements, *International J.Math. Combin.*, Vol.2(2015), 1-31.
- [21] C.Neuhauser, Mathematical challenges in spatial ecology, *Notices in AMS*, Vol.48, 11(2001), 1304-1414.
- [22] Quang Ho-Kim and Pham Xuan Yem, *Elementary Particles and Their Interactions*, Springer-Verlag Berlin Heidelberg, 1998.
- [23] F.Smarandache, *Paradoxist Geometry*, State Archives from Valcea, Rm. Valcea, Romania, 1969, and in *Paradoxist Mathematics*, Collected Papers (Vol. II), Kishinev University Press, Kishinev, 5-28, 1997.
- [24] F.Smarandache, A new form of matter – unmatter, composed of particles and anti-particles, *Progress in Physics*, Vol.1(2005), 9-11.
- [25] F.Smarandache and D.Rabounski, Unmatter entities inside nuclei, predicted by the Brightsen nucleon cluster model, *Progress in Physics*, Vol.1(2006), 14-18.
- [26] J.Stillwell, *Classical Topology and Combinatorial Group Theory*, Springer - Verlag, New York Inc., 1980.
- [27] Wolfgang Walter, *Ordinary Differential Equations*, Springer-Verlag New York, Inc., 1998.
- [28] Y.Lou, Some reaction diffusion models in spatial ecology (in Chinese), *Sci.Sin. Math.*, Vol.45(2015), 1619-1634.

## Mathematics, the Continuous or the Discrete Which is Better to Reality of Things

**Abstract:** There are 2 contradictory views on our world, i.e., continuous or discrete, which results in that only partially reality of a thing  $T$  can be understood by one of continuous or discrete mathematics because of the universality of contradiction and the connection of things in the nature, just as the philosophical meaning in the story of the blind men with an elephant. Holding on the reality of natural things motivates the combination of continuous mathematics with that of discrete, i.e., an envelope theory called *mathematical combinatorics* which extends classical mathematics over topological graphs because a thing is nothing else but a multiverse over a spacial structure of graphs with conservation laws hold on its vertices. Such a mathematical object is said to be an *action flow*. The main purpose of this report is to introduce the powerful role of action flows, or mathematics over graphs with applications to physics, biology and other sciences, such as those of  $G$ -solution of non-solvable algebraic or differential equations, Banach or Hilbert  $\vec{G}$ -flow spaces with multiverse, multiverse on equations,  $\dots$  and with applications to, for examples, the understanding of particles, spacetime and biology. All of these make it clear that holding on the reality of things by classical mathematics is only on the coherent behaviors of things for its homogenous without contradictions, but the mathematics over graphs  $G$  is applicable for contradictory systems because contradiction is universal only in eyes of human beings but not the nature of a thing itself.

**Key Words:** Graph, Banach space, Smarandache multispace,  $\vec{G}$ -flow, observation, natural reality, non-solvable equation, mathematical combinatorics.

**AMS(2010):** 03A10,05C15,20A05, 34A26,35A01,51A05,51D20,53A35.

### §1. Introduction

Generally, the reality of a thing  $T$  is its state of existed, exists, or will exist in the world, whether or not they are observable or comprehensible by human beings. However, the recognized reality maybe very different from that of the truth because it depends on the way of the observer and his world view is continuous or discrete, i.e., view the behavior of thing  $T$  a continuous function  $f$ , or an infinite or finite sequence  $x_1, x_2, \dots, x_n$  with  $n \geq 1$  on time  $t$ .

*Is our world continuous or discrete?* Certainly not because there exist both continuous or discrete things in the eyes of human beings. For example, all apples on a tree is discrete but

---

<sup>1</sup>A plenary talk in the *2017 Spring International Conference on Applied and Engineering Mathematics*, April 18-20, 2017, Chengdu, P.R.China.

<sup>2</sup>*International J.Math. Combin.*, Vol.2(2017), 11-33

the moving of a car on the road is continuous, such as those figures (a) and (b) shown in Fig.1.



(a)



(b)

**Fig.1**

And historically, holding on the behavior of things mutually develops the continuous and discrete mathematics, i.e., research a discrete (continuous) question by that of continuous (discrete) mathematical methods. For example, let  $x$ ,  $y$  be the populations in a self-system of cats and rats, such as Tom and Jerry shown in Fig.2,

**Fig.2**

then they were continuously characterized by Lotka-Volterra with differential equations ([4])

$$\begin{cases} \dot{x} = x(\lambda - by), \\ \dot{y} = y(-\mu - cx). \end{cases} \quad (1.1)$$

Similarly, all numerical calculations by computer for continuous questions are carried out by discrete methods because algorithms language recognized by computer is essentially discrete. Such a typical example is the movies by discrete images for a continuous motion shown in Fig.3. Thus, the reality of things needs the combination of the continuous mathematics with that of the discrete.

**Fig.3**

Physically, the behavior of things  $T$  is usually characterized by differential equation

$$\mathcal{F}(t, x_1, x_2, x_3, \psi_t, \psi_{x_1}, \psi_{x_2}, \dots, \psi_{x_1 x_2}, \dots) = 0 \quad (1.2)$$

established on observed characters of  $\mu_1, \mu_2, \dots, \mu_n$  for its state function  $\psi(t, x)$  in reference system  $\mathbb{R}^3$  by Newtonian and  $\mathbb{R}^4$  by Einstein ([2]).



Fig.4

Usually, these physical phenomena of a thing is complex, and hybrid with other things. *Is the reality of particle  $P$  all solutions of that equation (1.2) in general?* Certainly not because the equation (1.2) only characterizes the behavior of  $P$  on some characters of  $\mu_1, \mu_2, \dots, \mu_n$  at time  $t$  abstractly, not the whole in philosophy. For example, the behavior of a particle is characterized by the Schrödinger equation

$$i\hbar \frac{\partial \psi}{\partial t} = -\frac{\hbar^2}{2m} \nabla^2 \psi + U\psi \quad (1.3)$$

in quantum mechanics ([24]) but observation shows it in two or more possible states of being, i.e., superposition such as the asking question of Schrödinger for the alive or dead of the cat in the box with poison switch shown in Fig.4. We can not even say which solution of the Schrödinger equation (1.3) is the particle because each solution is only for one determined state.

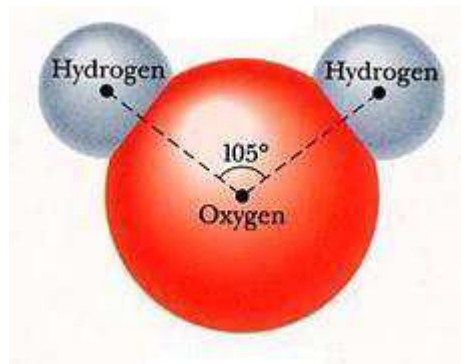

Fig.5

Furthermore, *can we conclude the equation (1.2) is absolutely right for a particle P?* Certainly not also because the dynamic equation (1.2) is always established with an additional assumption, i.e., the geometry on a particle  $P$  is a point in classical mechanics or a field in quantum mechanics and dependent on the observer is out or in the particle. For example, a water molecule  $H_2O$  consists of 2 hydrogen atoms and 1 oxygen atom such as those shown in Fig.5. If an observer receives information on the behaviors of hydrogen or oxygen atom but stands out of the water molecule  $H_2O$  by viewing it a geometrical point, then he can only receives coherent information on atoms  $H$  and  $O$  with the water molecule  $H_2O$ . But if he enters the interior of the molecule, he will view a different sceneries for atoms  $H$  and  $O$ , which are respectively called *out-observation* and *in-observation*, and establishes equation (1.3) on  $H_2O$  or 3 dynamic equations

$$\begin{cases} -i\hbar \frac{\partial \psi_O}{\partial t} = \frac{\hbar^2}{2m_O} \nabla^2 \psi_O - V(x) \psi_O \\ -i\hbar \frac{\partial \psi_{H_1}}{\partial t} = \frac{\hbar^2}{2m_{H_1}} \nabla^2 \psi_{H_1} - V(x) \psi_{H_1} \\ -i\hbar \frac{\partial \psi_{H_2}}{\partial t} = \frac{\hbar^2}{2m_{H_2}} \nabla^2 \psi_{H_2} - V(x) \psi_{H_2} \end{cases} \quad (1.4)$$

on atoms  $H$  and  $O$ . *Which is the right model on  $H_2O$ , the (1.3) or (1.4) dynamic equations?* The answer is not easy because the equation model (1.3) can only characterizes those of coherent behavior of atoms  $H$  and  $O$  in  $H_2O$ , but equations (1.4) have no solutions, i.e., non-solvable in mathematics ([17]).

The main purpose of this report is to clarify that the reality of a thing  $T$  should be a contradictory system in one's eyes, or multiverse with non-solvable systems of equations in geometry, conclude that they essentially describe its nature, which results in mathematical combinatorics, i.e., mathematics over graphs in space, and show its powerful role to mathematics with applications to elementary particles, gravitational field and other sciences, such as those of extended Banach or Hilbert  $\vec{G}$ -flow spaces, geometry on non-solvable systems of solvable differential equations,  $\dots$  with applications to the understanding of particles, population biology and other sciences.

For terminologies and notations not mentioned here, we follow references [1] for mechanics, [4] for biological mathematics, [8] for combinatorial geometry, [23]-[24] for elementary particles, and [25] for Smarandache systems and multispace, and all phenomenons discussed in this paper are assumed to be true in the nature.

## §2. Contradiction, a By-product of Non-complete Recognizing

A philosophical proposition following clarifies the fundamental relation between the reality and the reality understood by classical mathematics, which is clear but few peoples noted in the past.

**Proposition 2.1** *Let  $\mathcal{R}$  and  $\mathcal{MR}$  be respectively the sets of reality and the reality known by*



classical mathematics on things. Then

$$\mathcal{MR} \subset \mathcal{R} \quad \text{and} \quad \mathcal{MR} \neq \mathcal{R}. \quad (2.1)$$

*Proof* Notice that classical mathematical systems are homogenous without contradictions, i.e. a compatible one in logic but contradictions exist everywhere in philosophy. Thus, the reality known by classical mathematics on things can be only a subset of the reality set, i.e., the relation (2.1)

$$\mathcal{MR} \subset \mathcal{R} \quad \text{and} \quad \mathcal{MR} \neq \mathcal{R}. \quad \square$$

Although Proposition 2.1 is simple but it implies that for holding on reality of things, an envelope theory on classical mathematics, i.e., mathematics including contradictions is needed to establish for human beings.

## 2.1 Thinking Models

Let us discuss 3 thinking models following.

**T1. The Blind Men with an Elephant.** This is a famous story in Buddhism which implies the entire consisting of its parts but we always hold on parts. In this story, there are six blind men were asked to determine what an elephant looked like by feeling different parts of an elephant's body. The man touched the elephant's leg, tail, trunk, ear, belly or tusk respectively claims it's like a pillar, a rope, a tree branch, a hand fan, a wall or a solid pipe, such as those shown in Fig.6.

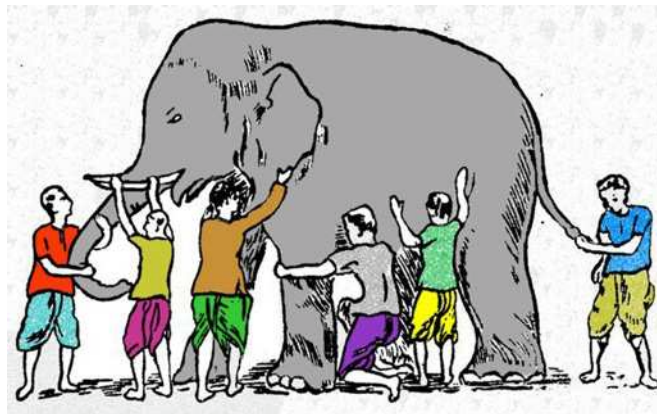

Fig.6

Each of these blind men insisted on his own's right, not accepted others, and then entered into an endless argument. *All of you are right!* A wise man explains to them: *why are you telling it differently is because each one of you touched the different part of the elephant. So, actually the elephant has all those features what you all said.* Hence, the wise man told these

blind man that an elephant seemingly looked

$$\begin{aligned} \text{An elephant} &= \{4 \text{ pillars}\} \cup \{1 \text{ rope}\} \cup \{1 \text{ tree branch}\} \\ &\cup \{2 \text{ hand fans}\} \cup \{1 \text{ wall}\} \cup \{1 \text{ solid pipe}\} \end{aligned} \quad (2.2)$$

*What is the implication of this story for human beings?* It lies in the situation that human beings understand things in the world is analogous to these blind men. Usually, a thing  $T$  is understood by its known characters at one by one time and known gradually. For example, let  $\mu_1, \mu_2, \dots, \mu_n$  be known and  $\nu_i, i \geq 1$  unknown characters on a thing  $T$  at time  $t$ . Then,  $T$  is understood by

$$T = \left( \bigcup_{i=1}^n \{\mu_i\} \right) \cup \left( \bigcup_{k \geq 1} \{\nu_k\} \right) \quad (2.3)$$

in logic and with an approximation  $T^\circ = \bigcup_{i=1}^n \{\mu_i\}$  at time  $t$ . The equation (2.3) is called the *Smarandache multispace* ([8], [25]), a combination of discrete characters for understanding a thing  $T$ .

**T2. Everett's Multiverse on Superposition.** The multiverse interpretation by H.Everett [3] on wave function of equation (1.3) in 1957 answered the superposition of particles in machinery. By an assumption that the wave function of an observer would be interacted with a superposed object, he concluded different worlds in different quantum system obeying equation (1.3) and the superposition of a particle be liked those separate arms of a 2-branching universe ([16], [17]) such as those shown in Fig.7,

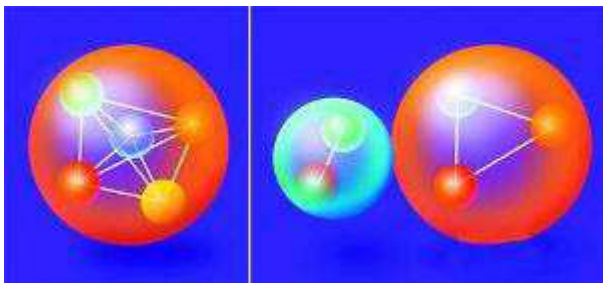

Fig.7

which revolutionary changed an ambiguous interpretation in quantum mechanics before him, i.e., an observer will cause the wave function to collapse randomly into one of the alternatives with all others disappearing. Everett's multiverse interpretation on the superposition of particle is in fact alluded in thinking model  $T1$ , i.e., the story of blind men with an elephant because if one views each of these pillar, rope, tree branch, hand fan, wall and solid pipe by these blind men feeling on different parts of the elephant to be different spaces, then the looks of an elephant of the wise man told these blind men (2.2) is nothing else but an Everett's multiverse.

**T3. Quarks Model.** The divisibility of matter initiates human beings to search elemen-

tary constituting cells of matter, i.e., elementary particles such as those of quarks, leptons with interaction quanta including photons and other particles of mediated interactions, also with those of their antiparticles at present ([23], [24]), and unmatters between a matter and its antimatter which is partially consisted of matter but others antimatter ([26], [27]). For example, a baryon is predominantly formed by three quarks, and a meson is mainly composed of a quark and an antiquark in the models of Sakata, or Gell-Mann and Ne'eman, such as those shown in Fig.8, where there is also a particle composed of 5 quarks.



**Fig.8**

However, a free quark was never found in experiments. We can not even conclude the Schrödinger equations (1.3) is the right equation on quarks. But *why is it believed without a shadow of doubt that the dynamical equation of elementary particles such as those of quarks, leptons with interaction quanta is (1.3) in physics?* The reason is because that all observations come from a macro viewpoint, the human beings, not the quarks, and which can only lead to coherent behaviors, not the individuals. In mathematics, it is just an equation on those of particles viewed abstractly to be a geometrical point or an independent field from a macroscopic point, which results in physicists assuming the internal structures mechanically for understanding behaviors of particles, such as those shown in Fig.8. However, such an assumption is a little ambiguous in logic, i.e., we can not even distinguish who is the geometrical point or the field, the particle or its quark.

## 2.2 Contradiction Originated in Non-complete Recognizing

If we completely understand a thing  $T$ , i.e.,  $T = T^o$  in formula (2.3) at time  $t$ , there are no contradiction on  $T$ . However, this is nearly impossible for human beings, concluded in the first chapter of *TAO TEH KING* written by *Lao Zi*, a famous ideologist in China, i.e., “Name named is not the eternal; the without is the nature and naming the origin of things”, which also implies the universality of contradiction and a generalization of equation (2.1).

Certainly, the looks (2.2) of the wise man on the elephant is a complete recognizing but these of the blind men is not. However, *which is the right way of recognizing?* The answer depends on the standing view of observer. The observation of these blind men on the elephant are a microscopic or in-observing but the wise man is macroscopic or out-observing. If one needs only for the macroscopic of an elephant, the wise man is right, but for the microscopic, these blind men are right on the different parts of the elephant. For understanding the reality

of a thing  $T$ , we need the complete by individual recognizing, i.e., the whole by its parts. Such an observing is called a *parallel observing* ([17]) for avoiding the defect that each observer can only observe one behavior of a thing, such as those shown in Fig.9 on the water molecule  $H_2O$  with 3 observers.

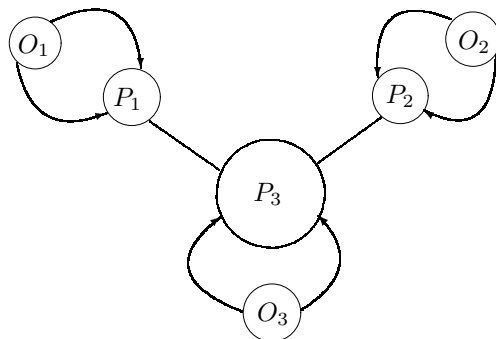

**Fig.9**

Thus, the looks of the wise man on an elephant is a collection of parallel observing by these 6 blind men and finally results in the recognizing (2.2), and also the Everett's multiverse interpretation on the superposition, the models of Sakata, or Gell-Mann and Ne'eman on particles. This also concludes that multiverse exists everywhere if we observing a thing  $T$  by in-observation, not only those levels of  $I - IV$  classified by Max Tegmark in [28].

However, these equations (1.2) established on parallel observing datum of multiverse, for instance the equations (1.4) on 2 hydrogen atoms and 1 oxygen atom ([17]), and generally, differential equations (1.2) on population biology with more than 3 species are generally non-solvable. Then, *how to understand the reality of a thing  $T$  by mathematics holding with an equality  $\mathcal{MR} = \mathcal{R}$* ? The best answer on this question is the combination of continuous mathematics with that of the discrete, i.e., turn these non-mathematics in the classical to mathematics by a combinatorial manner ([13]), i.e., *mathematical combinatorics*, which is the appropriated way for understanding the reality because all things are in contradiction.

### §3. Mathematical Combinatorics

#### 3.1 Labeled Graphs

A *graph*  $G$  is an ordered 2-tuple  $(V, E)$  with  $V \neq \emptyset$  and  $E \subset V \times V$ , where  $V$  and  $E$  are finite sets and respectively called the vertex set, the edge set of  $G$ , denoted by  $V(G)$  or  $E(G)$ , and a graph  $G$  is said to be embeddable into a topological space  $\mathcal{T}$  if there is a 1 – 1 continuous mapping  $\phi : G \rightarrow \mathcal{T}$  with  $\phi(p) \neq \phi(q)$  if  $p, q \notin V(G)$ . Particularly, if  $\mathcal{T} = \mathbb{R}^3$  such a topological graph is called *spacial graph* such as those shown in Fig.10 for cube  $C_4 \times C_4$ ,

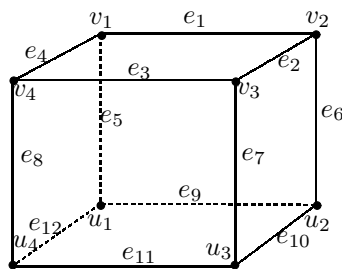

Fig.10

and a labeling on a graph  $G$  is a mapping  $L : V(G) \cup E(G) \rightarrow \mathcal{L}$  with a labeling set  $\mathcal{L}$ . For example,  $\mathcal{L} = \{v_i, u_i, e_j, 1 \leq i \leq 4, 1 \leq j \leq 12\}$  in Fig.10. Notice that the inherent structure of an elephant finding by these blind men is a labeled tree shown in Fig.11,

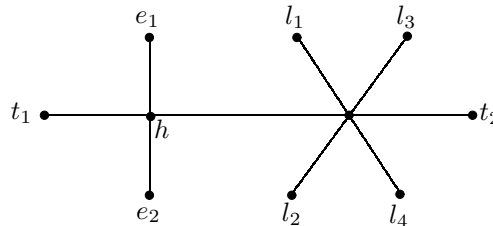

Fig.11

where,  $\{t_1\}$  =tusk,  $\{e_1, e_2\}$  =ears,  $\{h\}$  =head,  $\{b\}$  =belly,  $\{l_1, l_2, l_3, l_4\}$  =legs and  $\{t_2\}$  =tail. Then, *how can one rebuilt the geometric space of an elephant from the labeled tree in space  $\mathbb{R}^3$* ? First, one can blows up all edges, i.e.,  $e \rightarrow$  a cylinder for  $\forall e \in E(G^L)$  and then, homeomorphically transforms these cylinders as parts of an elephant. After these transformations, a 3-dimensional elephant is built again in  $\mathbb{R}^3$  such as those shown in Fig.12.

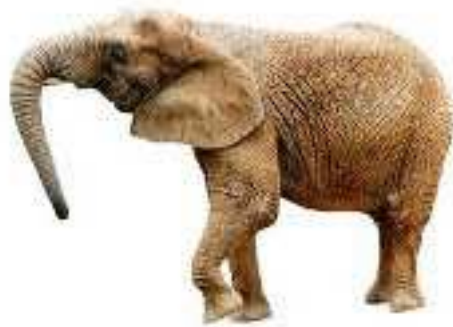

Fig.12

All of these discussions implies that labeled graph should be a mathematical element for understanding things ([20]), not only a labeling game because of

$$\text{Labeled Graphs in } \mathbb{R}^n \Leftrightarrow \text{Inherent Structure of Things.}$$

But *what are labels on labeled graphs, is it just different symbols? And are such labeled graphs a mechanism for the reality of things, or only a labeling game?* In fact, labeled graphs are researched mainly on symbols, not mathematical elements. If one puts off this assumption, i.e., labeling a graph by elements in mathematical systems, *what will happens? Are these resultants important for understanding things in the world?* The answer is certainly yes ([6], [7]) because this step will enable one to pullback more characters of things, particularly the metrics in physics, characterize things precisely and then holds on the reality of things.

### 3.2 G-Solutions on Equations

Let  $\mathcal{F} : \mathbb{R}^n \times \mathbb{R}^m \rightarrow \mathbb{R}^m$  be a  $\mathbb{C}^k$ ,  $1 \leq k \leq \infty$  mapping with  $\mathcal{F}(\bar{x}_0, \bar{y}_0) = \bar{0}$  for  $\bar{x}_0 \in \mathbb{R}^n$ ,  $\bar{y}_0 \in \mathbb{R}^m$  and a non-singular  $m \times m$  matrix  $(\partial \mathcal{F}^j / \partial y^i(\bar{x}_0, \bar{y}_0))$ . Then the implicit mapping theorem concludes that there exist opened neighborhoods  $V \subset \mathbb{R}^n$  of  $\bar{x}_0$ ,  $W \subset \mathbb{R}^m$  of  $\bar{y}_0$  and a  $\mathbb{C}^k$  mapping  $\phi : V \rightarrow W$  such that  $T(\bar{x}, \phi(\bar{x})) = \bar{0}$ , i.e., equation (1.2) is always solvable.

Let  $\mathcal{F}_1, \mathcal{F}_2, \dots, \mathcal{F}_m$  be  $m$  mappings holding in conditions of the implicit mapping theorem and let  $S_{\mathcal{F}_i} \subset \mathbb{R}^n$  be a manifold such that  $\mathcal{F}_i : S_{\mathcal{F}_i} \rightarrow 0$  for integers  $1 \leq i \leq m$ . Consider the equations

$$\begin{cases} \mathcal{F}_1(x_1, x_2, \dots, x_n) = 0 \\ \mathcal{F}_2(x_1, x_2, \dots, x_n) = 0 \\ \dots\dots\dots \\ \mathcal{F}_m(x_1, x_2, \dots, x_n) = 0 \end{cases} \tag{3.1}$$

in Euclidean space  $\mathbb{R}^n, n \geq 1$ . Geometrically, the system (3.1) is non-solvable or not dependent on  $\bigcap_{i=1}^m S_{\mathcal{F}_i} = \emptyset$  or  $\neq \emptyset$ .

Now, *is the non-solvable case meaningless for understanding the reality of things?* Certainly not because the non-solvable case of (3.1) only concludes the intersection  $\bigcap_{i=1}^m S_{\mathcal{F}_i} = \emptyset$ , the behavior of the solvable and non-solvable cases should be both characterized by the union  $\bigcup_{i=1}^m S_{\mathcal{F}_i}$  such as those shown in (2.2) for the elephant.

For example, if things  $T_1, T_2, T_3, T_4$  and  $T'_1, T'_2, T'_3, T'_4$  are respectively characterized by systems of equations following

$$(LES_4^N) \begin{cases} x + y = 1 \\ x + y = -1 \\ x - y = -1 \\ x - y = 1 \end{cases} \qquad (LES_4^S) \begin{cases} x = y \\ x + y = 2 \\ x = 1 \\ y = 1 \end{cases}$$

it is clear that  $(LES_4^N)$  is non-solvable because  $x + y = -1$  is contradictious to  $x + y = 1$ , and so that for equations  $x - y = -1$  and  $x - y = 1$ , i.e., there are no solutions  $x_0, y_0$  hold with this system. But  $(LES_4^S)$  is solvable with  $x = 1$  and  $y = 1$ . *Can we conclude that things  $T'_1, T'_2, T'_3, T'_4$  are  $x = 1, y = 1$  and  $T_1, T_2, T_3, T_4$  are nothing?* Certainly not because

$(x, y) = (1, 1)$  is the intersection of straight line behavior of things  $T'_1, T'_2, T'_3, T'_4$  and there are no intersection of  $T_1, T_2, T_3, T_4$  in plane  $\mathbb{R}^2$ . However, they are indeed exist in  $\mathbb{R}^2$  such as those shown in Fig.13.

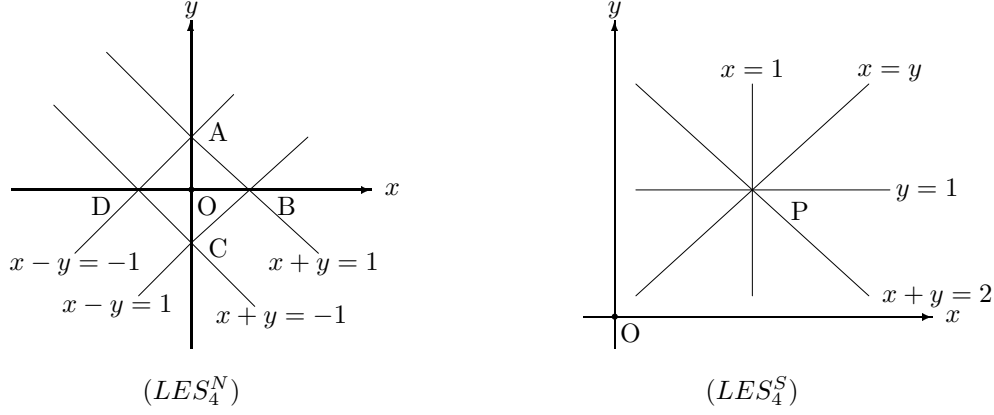

Fig.13

Let  $L_{a,b,c} = \{(x, y) | ax + by = c, ab \neq 0\}$  be points in  $\mathbb{R}^2$ . We are easily know the straight line behaviors of  $T_1, T_2, T_3, T_4$  and  $T'_1, T'_2, T'_3, T'_4$  are nothings else but the unions  $L_{1,-1,0} \cup L_{1,1,2} \cup L_{1,0,1} \cup L_{0,1,1}$  and  $L_{1,1,1} \cup L_{1,1,-1} \cup L_{1,-1,-1} \cup L_{1,-1,1}$ , respectively.

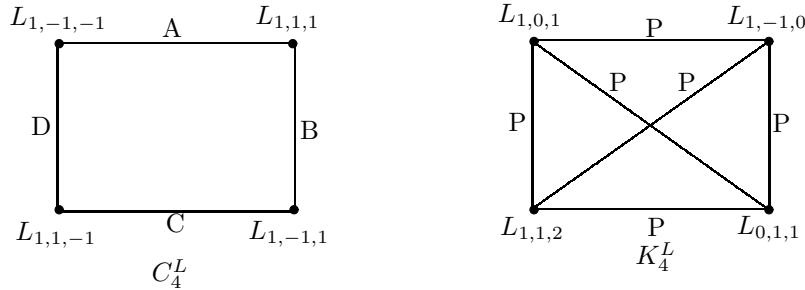

Fig.14

**Definition 3.1** A  $G$ -solution of system (3.1) is a labeling graph  $G^L$  defined by

$$V(G) = \{S_{\mathcal{F}_i}, 1 \leq i \leq n\};$$

$$E(G) = \{(S_{\mathcal{F}_i}, S_{\mathcal{F}_j}) \text{ if } S_{\mathcal{F}_i} \cap S_{\mathcal{F}_j} \neq \emptyset \text{ for integers } 1 \leq i, j \leq n\} \text{ with a labeling}$$

$$L : S_{\mathcal{F}_i} \rightarrow S_{\mathcal{F}_i}, \quad (S_{\mathcal{F}_i}, S_{\mathcal{F}_j}) \rightarrow S_{\mathcal{F}_i} \cap S_{\mathcal{F}_j}.$$

For Example, the  $G$ -solutions of  $(LES_4^N)$  and  $(LES_4^S)$  are respectively labeling graphs  $C_4^L$  and  $K_4^L$  shown in Fig.14. Generally, we know the following result.

**Theorem 3.2** A system (3.1) of equations is  $G$ -solvable if  $\mathcal{F}_i \in \mathbb{C}^1$  and  $\mathcal{F}_i|_{(x_1^0, x_2^0, \dots, x_n^0)} = 0$  but  $\frac{\partial \mathcal{F}_i}{\partial x_i} \Big|_{(x_1^0, x_2^0, \dots, x_n^0)} \neq 0$  for any integer  $i, 1 \leq i \leq n$ .

More results on combinatorics of non-solvable algebraic, ordinary or partial differential equations can be found in references [9]-[14]. For example, let  $(LDES_m^1)$  be a system of linear homogeneous differential equations

$$\begin{cases} \ddot{x} - 3\dot{x} + 2x = 0 & (1) \\ \ddot{x} - 5\dot{x} + 6x = 0 & (2) \\ \ddot{x} - 7\dot{x} + 12x = 0 & (3) \\ \ddot{x} - 9\dot{x} + 20x = 0 & (4) \\ \ddot{x} - 11\dot{x} + 30x = 0 & (5) \\ \ddot{x} - 7\dot{x} + 6x = 0 & (6) \end{cases}$$

where  $\ddot{x} = \frac{d^2x}{dt^2}$  and  $\dot{x} = \frac{dx}{dt}$ . Clearly, this system is non-solvable with solution bases  $\{e^t, e^{2t}\}$ ,  $\{e^{2t}, e^{3t}\}$ ,  $\{e^{3t}, e^{4t}\}$ ,  $\{e^{4t}, e^{5t}\}$ ,  $\{e^{5t}, e^{6t}\}$ ,  $\{e^{6t}, e^t\}$  respectively on equations (1) – (6) and its  $G$ -solution is shown in Fig.15,

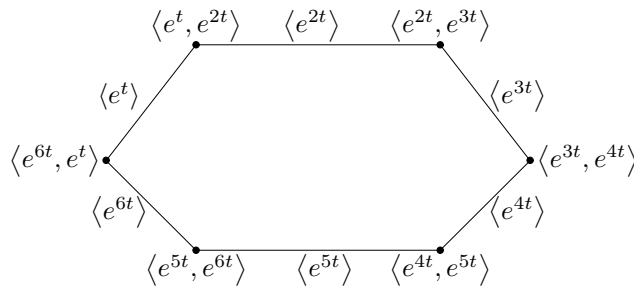

Fig.15

where  $\langle \Delta \rangle$  denotes the linear space generalized by elements in  $\Delta$ .

### 3.3 Mathematics over Graph

Let  $(\mathcal{A}; \circ_1, \circ_2, \dots, \circ_k)$  be an algebraic system, i.e.,  $a \circ_i b \in \mathcal{A}$  for  $\forall a, b \in \mathcal{A}$ ,  $1 \leq i \leq k$  and let  $\vec{G}$  be an oriented graph embedded in space  $\mathcal{T}$ . Denoted by  $\vec{G}_{\mathcal{A}}^L$  all of those labeled graphs  $\vec{G}^L$  with labeling  $L : E(\vec{G}) \rightarrow \mathcal{A}$  constraint with ruler:

**R1 :** For  $\forall \vec{G}^{L_1}, \vec{G}^{L_2} \in \vec{G}_{\mathcal{A}}^L$ , define  $\vec{G}^{L_1} \circ_i \vec{G}^{L_2} = \vec{G}^{L_1 \circ_i L_2}$ , where  $L_1 \circ_i L_2 : e \rightarrow L_1(e) \circ_i L_2(e)$  for  $\forall e \in E(\vec{G})$  and integers  $1 \leq i \leq k$ .

For example, such a ruler on graph  $\vec{C}_4$  is shown in Fig.16, where  $\mathbf{a}_3 = \mathbf{a}_1 \circ_i \mathbf{a}_2$ ,  $\mathbf{b}_3 = \mathbf{b}_1 \circ_i \mathbf{b}_2$ ,  $\mathbf{c}_3 = \mathbf{c}_1 \circ_i \mathbf{c}_2$ ,  $\mathbf{d}_3 = \mathbf{d}_1 \circ_i \mathbf{d}_2$ .



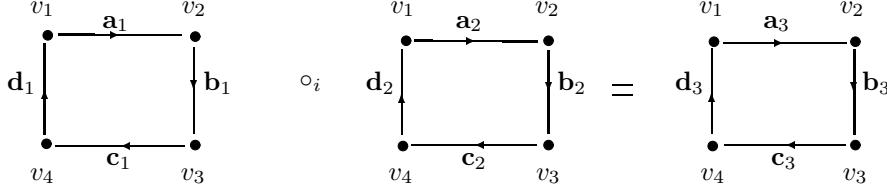

Fig.16

Then,  $\vec{G}^{L_1} \circ_i \vec{G}^{L_2} = \vec{G}^{L_1 \circ_i L_2} \in \vec{G}_{\mathcal{A}}^L$  by the ruler **R1**, and generally,

$$\vec{G}^{L_1} \circ_{i_1} \vec{G}^{L_2} \circ_{i_2} \cdots \circ_{i_s} \vec{G}^{L_{s+1}} \in \vec{G}_{\mathcal{A}}^L$$

for integers  $1 \leq i_1, i_2, \dots, i_s \leq k$ , i.e.,  $\vec{G}_{\mathcal{A}}^L$  is also an algebraic system, and it is commutative on an operation  $\circ_i$  if  $(\mathcal{A}; \circ_1, \circ_2, \dots, \circ_k)$  is commutative on an operation  $\circ_i$  for an integer  $i$ ,  $1 \leq i \leq k$ . Particularly, if  $k = 1$ ,  $\vec{G}_{\mathcal{A}}^L$  is a group if  $(\mathcal{A}; \circ_1)$  is a group. Thus, we extend  $(\mathcal{A}; \circ_1, \circ_2, \dots, \circ_k)$  and obtain an algebraic system over graph  $\vec{G}$  underlying a geometrical structure in space  $\mathcal{T}$ .

Notice that such an extension  $\vec{G}_{\mathcal{A}}^L$  is only a pure extension of algebra over  $\vec{G}$  without combining the nature of things, i.e., the conservation of matter which states that the amount of the conserved quantity at a point or within a volume can only change by the amount of the quantity which flows in or out of that volume. Thus, understanding the reality of things motives the extension of mathematical systems  $(\mathcal{A}; \circ_1, \circ_2, \dots, \circ_k)$  over graph  $\vec{G}$  constrained also on the laws of conservation

**R2**:  $\sum_l \mathbf{F}(v)_l^- = \sum_s \mathbf{F}(v)_s^+$ , where  $\mathbf{F}(v)_l^-$ ,  $l \geq 1$  and  $\mathbf{F}(v)_s^+$ ,  $s \geq 1$  denote respectively the output and input amounts at vertex  $v \in E(\vec{G})$ .

This notion brings about a new mathematical element finally, i.e., action flows, which combines well the continuous mathematics with that of the discrete.

**Definition 3.3**([19]) An action flow  $(\vec{G}; L, A)$  is an oriented embedded graph  $\vec{G}$  in a topological space  $\mathcal{S}$  associated with a mapping  $L : (v, u) \rightarrow L(v, u)$ , 2 end-operators  $A_{vu}^+ : L(v, u) \rightarrow L^{A_{vu}^+}(v, u)$  and  $A_{uv}^+ : L(u, v) \rightarrow L^{A_{uv}^+}(u, v)$  on a Banach space  $\mathcal{B}$

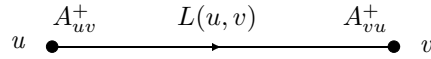

Fig.17

with  $L(v, u) = -L(u, v)$  and  $A_{vu}^+(-L(v, u)) = -L^{A_{vu}^+}(v, u)$  for  $\forall (v, u) \in E(\vec{G})$  holding with conservation laws

$$\sum_{u \in N_G(v)} L^{A_{vu}^+}(v, u) = \mathbf{c}_v \quad \text{for } \forall v \in V(\vec{G})$$

such as those shown for vertex  $v$  in Fig.18 following

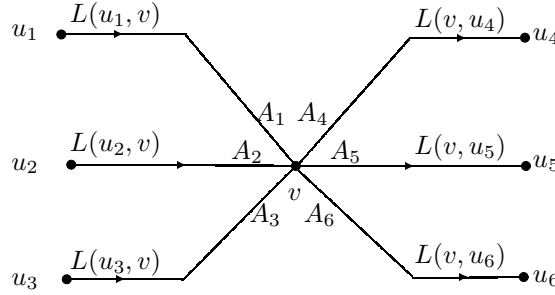

Fig.18

with a conservation law

$$-L^{A_1}(v, u_1) - L^{A_2}(v, u_2) - L^{A_3}(v, u_3) + L^{A_4}(v, u_4) + L^{A_5}(v, u_5) + L^{A_6}(v, u_6) = \mathbf{c}_v,$$

where  $\mathbf{c}_v$  is the surplus flow on vertex  $v$ , and usually, let  $\mathbf{c}_v = \mathbf{0}$ .

Indeed, action flow is an element both with the character of continuous and discrete mathematics. For example, the conservation laws on an action flow over dipole shown in Fig.19

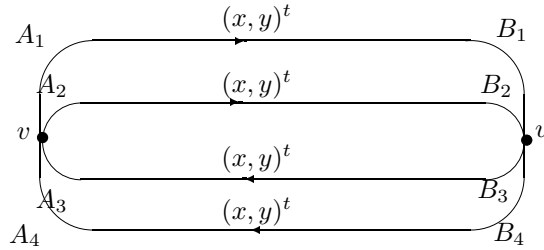

Fig.19

are partial differential equations

$$\begin{cases} a_1 \frac{\partial^2 x}{\partial t^2} + b_1 \frac{\partial^2 y}{\partial t^2} - a_3 \frac{\partial x}{\partial t} + (a_2 - a_4)x + (b_2 - b_3 - b_4)y = 0 \\ c_2 \frac{\partial^2 x}{\partial t^2} + d_2 \frac{\partial^2 y}{\partial t^2} - d_4 \frac{\partial y}{\partial t} + (c_1 - c_3 - c_4)x + (d_1 - d_3)y = 0 \end{cases},$$

where,  $A_1 = (a_1 \partial^2 / \partial t^2, b_1 \partial^2 / \partial t^2)$ ,  $A_2 = (a_2, b_2)$ ,  $A_3 = (a_3 \partial / \partial t, b_3)$ ,  $A_4 = (a_4, b_4)$ ,  $B_1 = (c_1, d_1)$ ,  $B_2 = (c_2 \partial^2 / \partial t^2, d_2 \partial^2 / \partial t^2)$ ,  $B_3 = (c_3, d_3)$ ,  $B_4 = (c_4, d_4 \partial / \partial t)$ .

Certainly, not all mathematical systems can be extended over a graph  $\vec{G}$  constraint with the laws of conservation at  $v \in V(\vec{G})$  unless  $\vec{G}$  with special structure but such an extension of linear space  $\mathcal{A}$  can be always done.

**Theorem 3.4**([20]) *Let  $(\mathcal{A}; +, \cdot)$  be a linear space,  $\vec{G}$  an embedded graph in space  $\mathcal{T}$  and  $A_{vu}^+ = A_{uv}^+ = \mathbf{1}_{\mathcal{A}}$  for  $\forall (v, u) \in E(\vec{G})$ . Then,  $(\vec{G}_{\mathcal{A}}^L; +, \cdot)$  is also a linear space under rulers **R1** and **R2** with dimension  $\dim \mathcal{A}^{\beta(\vec{G})}$  if  $\dim \mathcal{V} < \infty$ , where  $\beta(\vec{G}) = |E(\vec{G})| - |V(\vec{G})| + 1$ , or infinite.*

An action flow  $(\vec{G}; L, \mathbf{1}_{\mathcal{A}})$ , i.e.,  $A_{vu}^+ = A_{uv}^+ = \mathbf{1}_{\mathcal{A}}$  for  $\forall(v, u) \in E(\vec{G})$  is usually called  $\vec{G}$ -flows, denoted by  $\vec{G}^L$  and the linear space  $(\vec{G}_{\mathcal{A}}^L; +, \cdot)$  extended over  $\vec{G}$  by  $\vec{G}^{\mathcal{A}}$  for simplicity.

#### §4. Banach $\vec{G}$ -Flow Spaces with Multiverses

##### 4.1 Banach $\vec{G}$ -Flow Space

A Banach or Hilbert space is respectively a linear space  $\mathcal{A}$  over a field  $\mathbb{R}$  or  $\mathbb{C}$  equipped with a complete norm  $\|\cdot\|$  or inner product  $\langle \cdot, \cdot \rangle$ , i.e., for every Cauchy sequence  $\{x_n\}$  in  $\mathcal{A}$ , there exists an element  $x$  in  $\mathcal{A}$  such that

$$\lim_{n \rightarrow \infty} \|x_n - x\|_{\mathcal{A}} = 0 \quad \text{or} \quad \lim_{n \rightarrow \infty} \langle x_n - x, x_n - x \rangle_{\mathcal{A}} = 0,$$

which can be extended over graph  $\vec{G}$  by introducing the norm of a  $\vec{G}$ -flow  $\vec{G}^L$  following

$$\|\vec{G}^L\| = \sum_{(v,u) \in E(\vec{G})} \|L(v, u)\|,$$

where  $\|L(v, u)\|$  is the norm of  $L(v, u)$  in  $\mathcal{A}$ .

**Theorem 4.1**([15]) *For any graph  $\vec{G}$ ,  $\vec{G}^{\mathcal{A}}$  is a Banach space, and furthermore, if  $\mathcal{A}$  is a Hilbert space,  $\vec{G}^{\mathcal{A}}$  is a Hilbert space too.*

We can also consider operators action on the Banach or Hilbert  $\vec{G}$ -flow space  $\vec{G}^{\mathcal{A}}$ . Particularly, an operator  $\mathbf{T} : \vec{G}^{\mathcal{A}} \rightarrow \vec{G}^{\mathcal{A}}$  is *linear* if

$$\mathbf{T}(\lambda \vec{G}^{L_1} + \mu \vec{G}^{L_2}) = \lambda \mathbf{T}(\vec{G}^{L_1}) + \mu \mathbf{T}(\vec{G}^{L_2})$$

for  $\forall \vec{G}^{L_1}, \vec{G}^{L_2} \in \vec{G}^{\mathcal{A}}$ ,  $\lambda, \mu \in \mathcal{F}$ , which enables one to generalize the representation theorem of Fréchet and Riesz on linear continuous functionals of Hilbert space to Hilbert  $\vec{G}$ -flow space  $\vec{G}^{\mathcal{A}}$  following.

**Theorem 4.2**([15]) *Let  $\mathbf{T} : \vec{G}^{\mathcal{A}} \rightarrow \mathbb{C}$  be a linear continuous functional. Then there is a unique  $\vec{G}^{\hat{L}} \in \vec{G}^{\mathcal{A}}$  such that  $\mathbf{T}(\vec{G}^L) = \langle \vec{G}^L, \vec{G}^{\hat{L}} \rangle$  for  $\forall \vec{G}^L \in \vec{G}^{\mathcal{A}}$ .*

Notice that linear continuous functionals exist everywhere in mathematics, particularly, the differential and integral operators. For example, let  $\mathcal{A}$  be a Hilbert space consisting of measurable functions  $f(x_1, x_2, \dots, x_n)$  on a set

$$\Delta = \{(x_1, x_2, \dots, x_n) \in \mathbb{R}^n | a_i \leq x_i \leq b_i, 1 \leq i \leq n\},$$

which is a functional space  $L^2[\Delta]$  with inner product

$$\langle f(\mathbf{x}), g(\mathbf{x}) \rangle = \int_{\Delta} \overline{f(\mathbf{x})}g(\mathbf{x})d\mathbf{x} \text{ for } f(\mathbf{x}), g(\mathbf{x}) \in L^2[\Delta],$$

where  $\mathbf{x} = (x_1, x_2, \dots, x_n)$ . By Theorem 4.1,  $\mathcal{A}$  can be extended to Hilbert  $\vec{G}$ -flow space  $\vec{G}^{\mathcal{A}}$ , and the *differential* or *integral operators*

$$D = \sum_{i=1}^n a_i \frac{\partial}{\partial x_i} \text{ and } \int_{\Delta}$$

on  $\mathcal{A}$  are extended to  $\vec{G}^{\mathcal{A}}$  respectively by  $D\vec{G}^L = \vec{G}^{DL(v,u)}$  and

$$\int_{\Delta} \vec{G}^L = \int_{\Delta} K(\mathbf{x}, \mathbf{y}) \vec{G}^{L[\mathbf{y}]} d\mathbf{y} = \vec{G}^{\int_{\Delta} K(\mathbf{x}, \mathbf{y}) L(v,u)[\mathbf{y}] d\mathbf{y}}$$

for  $\forall (v, u) \in E(\vec{G})$ , where  $a_i, \frac{\partial a_i}{\partial x_j} \in C^0(\Delta)$  for integers  $1 \leq i, j \leq n$  and  $K(\mathbf{x}, \mathbf{y}) : \Delta \times \Delta \rightarrow \mathbb{C} \in L^2(\Delta \times \Delta, \mathbb{C})$  with

$$\int_{\Delta \times \Delta} K(\mathbf{x}, \mathbf{y}) d\mathbf{x}d\mathbf{y} < \infty.$$

**Theorem 4.3**([15]) *The differential or integral operator  $D : \vec{G}^{\mathcal{A}} \rightarrow \vec{G}^{\mathcal{A}}, \int_{\Delta} : \vec{G}^{\mathcal{A}} \rightarrow \vec{G}^{\mathcal{A}}$  both are linear operators on  $\vec{G}^{\mathcal{A}}$ .*

For example, let  $f(t) = t, g(t) = e^t, K(t, \tau) = t^2 + \tau^2$  for  $\Delta = [0, 1]$  and let  $\vec{G}^L$  be the  $\vec{G}$ -flow shown on the left in Fig.20. Then we get the  $\vec{G}$ -flows on the right in Fig.20 by the differential or integral operator action on.

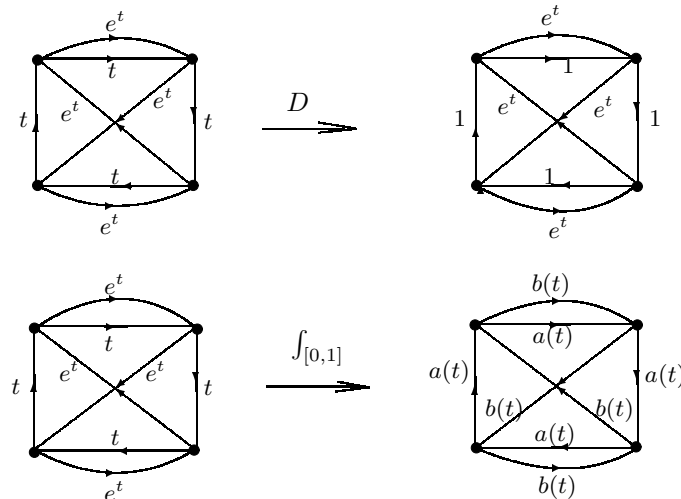

Fig.20

where  $a(t) = \frac{t^2}{2} + \frac{1}{4}$  and  $b(t) = (e - 1)t^2 + e - 2$ .

### 4.2 Multiverses on Equations

Notice that solving Schrödinger equation (1.3) with initial data only get one state of a particle  $P$  but the particle is in superposition, which brought the H.Everett multiverse on superposition and the quark model of Sakata, or Gell-Mann and Ne'eman on particles machinery. However, Theorems 4.1 – 4.3 enables one to get multiverses constraint with linear equations (3.1) in  $\vec{G}^{\mathcal{A}}$ .

For example, we can consider the Cauchy problem

$$\frac{\partial X}{\partial t} = c^2 \sum_{i=1}^n \frac{\partial^2 X}{\partial x_i^2}$$

with initial values  $X|_{t=t_0}$  in  $\vec{G}^{\mathbb{R}^n \times \mathbb{R}}$ , i.e., Hilbert space  $\mathbb{R}^n \times \mathbb{R}$  over graph  $\vec{G}$ , and get multiverse solutions of heat equation following.

**Theorem 4.4**([15]) *For  $\forall \vec{G}^{L'} \in \vec{G}^{\mathbb{R}^n \times \mathbb{R}}$  and a non-zero constant  $c$  in  $\mathbb{R}$ , the Cauchy problems on differential equation*

$$\frac{\partial X}{\partial t} = c^2 \sum_{i=1}^n \frac{\partial^2 X}{\partial x_i^2}$$

*with initial value  $X|_{t=t_0} = \vec{G}^{L'} \in \vec{G}^{\mathbb{R}^n \times \mathbb{R}}$  is solvable in  $\vec{G}^{\mathbb{R}^n \times \mathbb{R}}$  if  $L'(v, u)$  is continuous and bounded in  $\mathbb{R}^n$  for  $\forall (v, u) \in E(\vec{G})$ .*

And then, the H.Everett's multiverse on the Schrödinger equation (1.3) is nothing else but a 2-branch tree

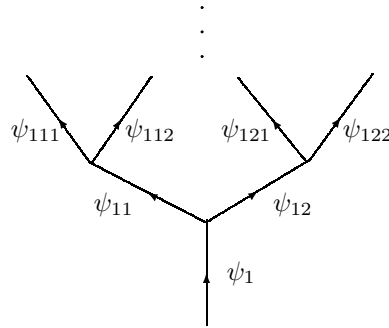

**Fig.21**

with equalities  $\psi_1 = \psi_{11} + \psi_{12}$ ,  $\psi_{11} = \psi_{111} + \psi_{112}$ ,  $\psi_{12} = \psi_{121} + \psi_{122}$ ,  $\dots$  ([16], [17]).

If the equations (3.1) is not linear, we can not immediately apply Theorems 4.1 – 4.3 to get multiverse over any graphs  $\vec{G}$ . However, if the graph  $\vec{G}$  is prescribed with special structures, for instance the circuit decomposable, we can also solve the Cauchy problem on an equation in Hilbert  $\vec{G}$ -flow space  $\vec{G}^{\mathcal{A}}$  if it is solvable in  $\mathcal{A}$  and obtain a general conclusion following, which enable us to interpret also the superposition of particles ([17]), biological diversity and establish multiverse model of spacetime in Einstein's gravitation.

**Theorem 4.5**([15]) *If the graph  $\vec{G}$  is strong-connected with circuit decomposition  $\vec{G} = \bigcup_{i=1}^l \vec{C}_i$  such that  $L(v, u) = L_i(\mathbf{x})$  for  $\forall(v, u) \in E(\vec{C}_i)$ ,  $1 \leq i \leq l$  and the Cauchy problem*

$$\begin{cases} \mathcal{F}_i(\mathbf{x}, u, u_{x_1}, \dots, u_{x_n}, u_{x_1 x_2}, \dots) = 0 \\ u|_{x_0} = L_i(\mathbf{x}) \end{cases}$$

*is solvable in a Hilbert space  $\mathcal{A}$  on domain  $\Delta \subset \mathbb{R}^n$  for integers  $1 \leq i \leq l$ , then the Cauchy problem*

$$\begin{cases} \mathcal{F}_i(\mathbf{x}, X, X_{x_1}, \dots, X_{x_n}, X_{x_1 x_2}, \dots) = 0 \\ X|_{x_0} = \vec{G}^L \end{cases}$$

*such that  $L(v, u) = L_i(\mathbf{x})$  for  $\forall(v, u) \in X(\vec{C}_i)$  is solvable for  $X \in \vec{G}^{\mathcal{A}}$ .*

Theorem 4.5 enables one to explore the multiverse, particularly, the solutions of Einstein's gravitational equations

$$R^{\mu\nu} - \frac{1}{2}Rg^{\mu\nu} + \lambda g^{\mu\nu} = -8\pi GT^{\mu\nu},$$

where  $R^{\mu\nu} = R_{\alpha}^{\mu\alpha\nu} = g_{\alpha\beta}R^{\alpha\mu\beta\nu}$ ,  $R = g_{\mu\nu}R^{\mu\nu}$  are the respective Ricci tensor, Ricci scalar curvature,  $G = 6.673 \times 10^{-8} \text{cm}^3/\text{gs}^2$ ,  $\kappa = 8\pi G/c^4 = 2.08 \times 10^{-48} \text{cm}^{-1} \cdot \text{g}^{-1} \cdot \text{s}^2$ . In fact, Einstein's general relativity is established on  $\mathbb{R}^4$ . However, *if the dimension  $n$  of the universe  $> 4$ , how can we characterize the structure of spacetime for the universe?* In fact, if the dimension of the universe  $> 4$ , all observations are nothing else but a projection of the true faces on our six organs because the dimension of human beings is 3 hold with

$$\mathbb{R}^n = \bigcup_{i=1}^m \mathbb{R}_i^4 \quad \text{and} \quad \left| \bigcap_{i=1}^m \mathbb{R}_i^4 \right| = 1$$

such as those shown in Fig.22 for a projection of 3-dimensional objects on Euclidean plane  $\mathbb{R}^2$ .

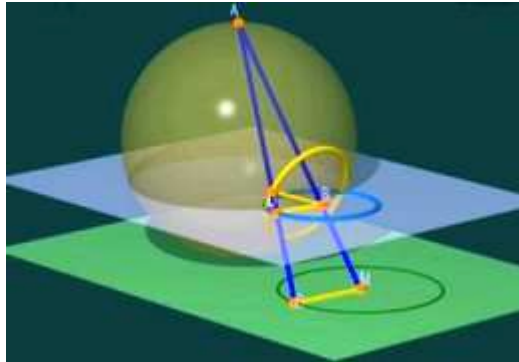

**Fig.22**

In this case, we can characterize the spacetime with a complete graph  $K_m^L$  labeled by  $\mathbb{R}^4$  ([7]-[8]). For example, if  $m = 4$  there are 4 Einstein's gravitational equations respectively on

$v \in V(K_4^L)$ . We can solve them one by one by applying the spherically symmetric solution in  $\mathbb{R}^4$  and construct  $K_4^L$  shown in Fig.23,

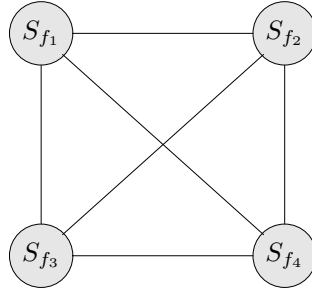

Fig.23

where, each  $S_{\mathcal{F}_i}$  is the geometrical space of the Schwarzschild spacetime

$$ds^2 = f(t) \left(1 - \frac{r_s}{r}\right) dt^2 - \frac{1}{1 - \frac{r_s}{r}} dr^2 - r^2(d\theta^2 + \sin^2 \theta d\phi^2)$$

for integers  $1 \leq i \leq 4$ .

Notice that  $m = 4$  is only an assumption. We do not know the exact value of  $m$  at present. Similarly, by Theorem 4.5 we can also get a conclusion on multiverse of the Einstein's gravitational equations, even in  $\mathbb{R}^4$ . Certainly, we do not know also which is the real spacetime of the universe.

**Theorem 4.6**([15], [19]) *There are infinite many  $\vec{G}$ -flow solutions on Einstein's gravitational equations*

$$R^{\mu\nu} - \frac{1}{2}Rg^{\mu\nu} = -8\pi GT^{\mu\nu}$$

in  $\vec{G}^{\mathbb{C}}$ , particularly on those graphs with circuit-decomposition  $\vec{G} = \bigcup_{i=1}^m \vec{C}_i$  labeled with Schwarzschild spacetime on their edges.

For example, let  $\vec{G} = \vec{C}_4$ . We are easily find  $\vec{C}_4$ -flow solution of Einstein's gravitational equations such as those shown in Fig.24.

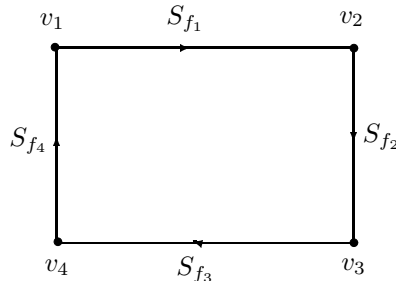

Fig.24

Then, the spacetime of the universe is nothing else but a curved ring in space such as those shown in Fig.25.

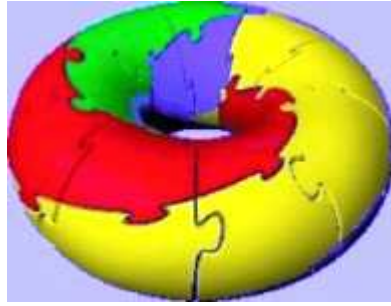

Fig.25

Generally, if  $\vec{G}$  is the union of  $m$  orientated circuits  $\vec{C}_i$ ,  $1 \leq i \leq m$ , Theorem 4.6 implies the spacetime of Einstein's gravitational equations is a multiverse consisting of  $m$  curved rings over graph  $\vec{G}$  in space.

Notice that a graph  $\vec{G}$  is circuit decomposable if and only if it is an Eulerian graph. Thus, Theorems 4.1 – 4.5 can be also applied to biology with global stability of food webs on  $n$  species following.

**Theorem 4.7**([21]) *A food web  $\vec{G}^L$  with initial value  $\vec{G}^{L_0}$  is globally stable or asymptotically stable if and only if there is an Eulerian multi-decomposition*

$$(\vec{G} \cup \overleftarrow{\vec{G}})^{\hat{L}} = \bigoplus_{i=1}^s \vec{H}_i^L$$

with solvable stable or asymptotically stable conservative equations on Eulerian subgraphs  $\vec{H}_i^L$  for integers  $1 \leq i \leq s$ , where  $(\vec{G} \cup \overleftarrow{\vec{G}})^{\hat{L}}$  is the bi-digraph of  $\vec{G}$  defined by  $\vec{G} \cup \overleftarrow{\vec{G}}$  with a labeling  $\hat{L} : V(\vec{G} \cup \overleftarrow{\vec{G}}) \rightarrow L(V(\vec{G}))$ ,  $\hat{L} : E(\vec{G} \cup \overleftarrow{\vec{G}}) \rightarrow L(E(\vec{G} \cup \overleftarrow{\vec{G}}))$  by  $\hat{L} : (u, v) \rightarrow \{0, (x, y), yf'\}$ ,  $(v, u) \rightarrow \{xf, (x, y), 0\}$  if  $L : (u, v) \rightarrow \{xf, (x, y), yf'\}$  for  $\forall (u, v) \in E(\vec{G})$ , such as those shown in Fig.26,

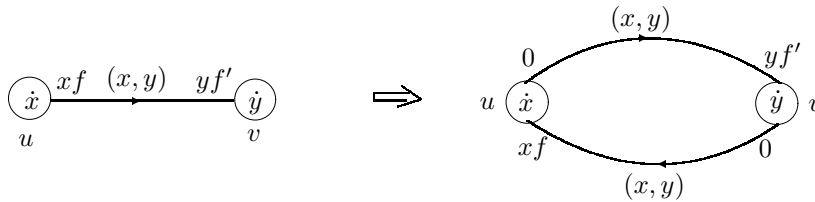

Fig.26

and a multi-decomposition  $\bigoplus_{i=1}^s \vec{H}_i^L$  of  $(\vec{G} \cup \overleftarrow{\vec{G}})^{\hat{L}}$  is defined by

$$(\vec{G} \cup \overleftarrow{\vec{G}})^{\hat{L}} = \bigcup_{i=1}^s \vec{H}_i$$



with  $\vec{H}_i \neq \vec{H}_j$ ,  $\vec{H}_i \cap \vec{H}_j = \emptyset$  or  $\neq \emptyset$  for integers  $1 \leq j \leq s$ .

**Theorem 4.8**([21]) *A food web  $\vec{G}^L$  with initial value  $\vec{G}^{L_0}$  is globally asymptotically stable if there is an Eulerian multi-decomposition*

$$\left(\vec{G} \cup \overleftarrow{G}\right)^{\hat{L}} = \bigoplus_{k=1}^s \vec{H}_k^L$$

with solvable conservative equations such that  $Re\lambda_i < 0$  for characteristic roots  $\lambda_i$  of  $A_v$  in the linearization

$$A_v X_v = 0_{h_v \times h_v}$$

of conservative equations at an equilibrium point  $\vec{H}_k^{L_0}$  in  $\vec{H}_k^L$  for integers  $1 \leq i \leq h_v$  and  $v \in V(\vec{H}_k^L)$ , where  $V(\vec{H}_k^L) = \{v_1, v_2, \dots, v_{h_v}\}$ ,

$$A_v = \begin{pmatrix} a_{11}^v & a_{12}^v & \cdots & a_{1h_v}^v \\ a_{21}^v & a_{22}^v & \cdots & a_{2h_v}^v \\ \cdots & \cdots & \cdots & \cdots \\ a_{h1}^v & a_{h2}^v & \cdots & a_{hh_v}^v \end{pmatrix}$$

a constant matrix and  $X_k = (x_{v_1}, x_{v_2}, \dots, x_{v_{h_v}})^T$  for integers  $1 \leq k \leq s$ .

## §5. Conclusion

Answer the question which is better to the reality of things on the continuous or discrete mathematics is not easy because our world appears both with the continuous and discrete characters. However, contradictions exist everywhere which are all artificial, not the nature of things. Thus, holding on the reality of things motivates one to turn contradictory systems to compatible systems, i.e., giving up the notion that contradiction is meaningless and establish an envelope theory on mathematics, which needs the combination of the continuous mathematics with that of discrete, i.e., mathematical combinatorics because a non-mathematics in classical is in fact a mathematics over a graph  $\vec{G}$  (See [13] for details).

## References

- [1] R.Abraham and J.E.Marsden, *Foundation of Mechanics* (2nd edition), Addison-Wesley, Reading, Mass, 1978.
- [2] A.Einstein, *Relativity: the Special and General Theory*, Methuen & Co Ltd., 1916.
- [3] H.Everett, Relative state formulation of quantum mechanics, *Rev.Mod.Phys.*, 29(1957), 454-462.
- [4] Fred Brauer and Carlos Castillo-Chaver, *Mathematical Models in Population Biology and Epidemiology*(2nd Edition), Springer, 2012.
- [5] Y.Lou, Some reaction diffusion models in spatial ecology (in Chinese), *Sci.Sin. Math.*,

- Vol.45(2015), 1619-1634.
- [6] Linfan Mao, Combinatorial speculation and combinatorial conjecture for mathematics, *International J.Math. Combin.* Vol.1(2007), No.1, 1-19.
  - [7] Linfan Mao, Geometrical theory on combinatorial manifolds, *JP J.Geometry and Topology*, Vol.7, No.1(2007),65-114.
  - [8] Linfan Mao, *Combinatorial Geometry with Applications to Field Theory*, The Education Publisher Inc., USA, 2011.
  - [9] Linfan Mao, Non-solvable spaces of linear equation systems, *International J.Math. Combin.*, Vol.2(2012), 9-23.
  - [10] Linfan Mao, Global stability of non-solvable ordinary differential equations with applications, *International J.Math. Combin.*, Vol.1 (2013), 1-37.
  - [11] Linfan Mao, Non-solvable equation systems with graphs embedded in  $\mathbf{R}^n$ , *Proceedings of the First International Conference on Smarandache Multispace and Multistructure*, The Education Publisher Inc. July, 2013.
  - [12] Linfan Mao, Geometry on  $G^L$ -systems of homogenous polynomials, *International J.Contemp. Math. Sciences*, Vol.9 (2014), No.6, 287-308.
  - [13] Linfan Mao, Mathematics on non-mathematics - A combinatorial contribution, *International J.Math. Combin.*, Vol.3(2014), 1-34.
  - [14] Linfan Mao, Cauchy problem on non-solvable system of first order partial differential equations with applications, *Methods and Applications of Analysis*, Vol.22, 2(2015), 171-200.
  - [15] Linfan Mao, Extended Banach  $\vec{G}$ -flow spaces on differential equations with applications, *Electronic J.Mathematical Analysis and Applications*, Vol.3, No.2 (2015), 59-91.
  - [16] Linfan Mao, A new understanding of particles by  $\vec{G}$ -flow interpretation of differential equation, *Progress in Physics*, Vol.11(2015), 193-201.
  - [17] Linfan Mao, A review on natural reality with physical equation, *Progress in Physics*, Vol.11(2015), 276-282.
  - [18] Linfan Mao, Mathematics after CC conjecture – combinatorial notions and achievements, *International J.Math. Combin.*, Vol.2(2015), 1-31.
  - [19] Linfan Mao, Mathematics with natural reality–action flows, *Bull.Cal.Math.Soc.*, Vol.107, 6(2015), 443-474.
  - [20] Linfan Mao, Labeled graph – A mathematical element, *International J.Math. Combin.*, Vol.3(2016), 27-56.
  - [21] Linfan Mao, Biological  $n$ -system with global stability, *Bull.Cal.Math.Soc.*, Vol.108, 6(2016), 403-430.
  - [22] J.D.Murray, *Mathematical Biology I: An Introduction* (3rd Edition), Springer-Verlag Berlin Heidelberg, 2002.
  - [23] Y.Nambu, *Quarks: Frontiers in Elementary Particle Physics*, World Scientific Publishing Co.Pte.Ltd, 1985.
  - [24] Quang Ho-Kim and Pham Xuan Yem, *Elementary Particles and Their Interactions*, Springer-Verlag Berlin Heidelberg, 1998.
  - [25] F.Smarandache, *Paradoxist Geometry*, State Archives from Valcea, Rm. Valcea, Romania, 1969, and in *Paradoxist Mathematics*, Collected Papers (Vol. II), Kishinev University

Press, Kishinev, 5-28, 1997.

- [26] F.Smarandache, A new form of matter – unmatter, composed of particles and anti-particles, *Progress in Physics*, Vol.1(2005), 9-11.
- [27] F.Smarandache and D.Rabounski, Unmatter entities inside nuclei, predicted by the Brightsen nucleon cluster model, *Progress in Physics*, Vol.1(2006), 14-18.
- [28] M.Tegmark, Parallel universes, in *Science and Ultimate Reality: From Quantum to Cosmos*, ed. by J.D.Barrow, P.C.W.Davies and C.L.Harper, Cambridge University Press, 2003.

## A New Understanding of Particles by $\vec{G}$ -Flow Interpretation of Differential Equation

**Abstract:** Applying mathematics to understanding of particles classically enables one with an assumption, i.e., if the variables  $t$  and  $x_1, x_2, x_3$  hold with a system of dynamical equations

$$\mathcal{F}_i(t, x_1, x_2, x_3, u_t, u_{x_1}, \dots, u_{x_1 x_2}, \dots) = 0, \quad 1 \leq i \leq m, \quad (DEq_m^4)$$

they are a point  $(t, x_1, x_2, x_3)$  in  $\mathbb{R}^4$ . However, *if we put off this assumption, how can we interpret the solution space of equations? And are these resultants important for understanding the world?* Recently, the author extended Banach and Hilbert spaces on a topological graph to introduce  $\vec{G}$ -flows and showed that all such flows on a topological graph  $\vec{G}$  also form a Banach or Hilbert space, which enables one to find the multiverse solution of equations  $(DEq_m^4)$  on  $\vec{G}$ . Applying this result, This paper discusses the  $\vec{G}$ -flow solutions on Schrödinger equation, Klein-Gordon equation and Dirac equation, i.e., the field equations of particles, bosons or fermions, answers previous questions by YES, and establishes the many world interpretation of quantum mechanics of H.Everett by purely mathematics in logic, i.e., mathematical combinatorics.

**Key Words:** Klein-Gordon equation, Dirac equation,  $\vec{G}$ -solution, many-world interpretation, multiverse, fermions, bosons, field.

**AMS(2010):** 03A10,05C15,20A05, 34A26,35A01,51A05,51D20,53A35

### §1. Introduction

All matters consist of two classes particles, i.e., bosons with integer spin  $n$ , fermions with fractional spin  $n/2$ ,  $n \equiv 1(\text{mod}2)$ , and by a widely held view, the elementary particles consists of quarks and leptons with interaction quanta including photons and other particles of mediated interactions ([16]), which constitute hadrons, i.e., mesons, baryons and their antiparticles. Thus, a hadron has an internal structure, which implies that all hadrons are not elementary but leptons are, viewed as point particles in elementary physics. Furthermore, there are also unmatter which is neither matter nor antimatter, but something in between ([19-21]). For example, an atom of unmatter is formed either by electrons, protons, and antineutrons, or by antielectrons, antiprotons, and neutrons.

Usually, a particle is characterized by solutions of differential equation established on its wave function  $\psi(t, x)$ . In non-relativistic quantum mechanics, the wave function  $\psi(t, x)$  of a

---

<sup>1</sup> *Progress in Physics*, Vol.11, 3 (2015),193-201

particle of mass  $m$  obeys the Schrödinger equation

$$i\hbar\frac{\partial\psi}{\partial t} = -\frac{\hbar^2}{2m}\nabla^2\psi + U, \quad (1.1)$$

where,  $\hbar = 6.582 \times 10^{-22} MeVs$  is the Planck constant,  $U$  is the potential energy of the particle in applied field and

$$\nabla = \left( \frac{\partial}{\partial x}, \frac{\partial}{\partial y}, \frac{\partial}{\partial z} \right) \quad \text{and} \quad \nabla^2 = \frac{\partial^2}{\partial x^2} + \frac{\partial^2}{\partial y^2} + \frac{\partial^2}{\partial z^2}.$$

Consequently, a free boson  $\psi(t, x)$  hold with the Klein-Gordon equation

$$\left( \frac{1}{c^2} \frac{\partial^2}{\partial t^2} - \nabla^2 \right) \psi(x, t) + \left( \frac{mc}{\hbar} \right)^2 \psi(x, t) = 0 \quad (1.2)$$

and a free fermion  $\psi(t, x)$  satisfies the Dirac equation

$$\left( i\gamma^\mu \partial_\mu - \frac{mc}{\hbar} \right) \psi(t, x) = 0 \quad (1.3)$$

in relativistic forms, where,  $\gamma^\mu = (\gamma^0, \gamma^1, \gamma^2, \gamma^3)$ ,  $\partial_\mu = \left( \frac{1}{c} \frac{\partial}{\partial t}, \frac{\partial}{\partial x_1}, \frac{\partial}{\partial x_2}, \frac{\partial}{\partial x_3} \right)$ ,  $c$  is the speed of light and

$$\gamma^0 = \begin{pmatrix} I_{2 \times 2} & 0 \\ 0 & -I_{2 \times 2} \end{pmatrix}, \quad \gamma^i = \begin{pmatrix} 0 & \sigma_i \\ -\sigma_i & 0 \end{pmatrix}$$

with the usual Pauli matrices

$$\sigma_1 = \begin{pmatrix} 0 & 1 \\ 1 & 0 \end{pmatrix}, \quad \sigma_2 = \begin{pmatrix} 0 & -i \\ i & 0 \end{pmatrix}, \quad \sigma_3 = \begin{pmatrix} 1 & 0 \\ 0 & -1 \end{pmatrix}.$$

It is well known that the behavior of a particle is on superposition, i.e., in two or more possible states of being. But *how to interpret this phenomenon in according with equation (1.1)-(1.3)*? The many worlds interpretation by H.Everett [2] on wave function of equation (1.1) in 1957 answered the question in machinery, i.e., viewed different worlds in different quantum mechanics and the superposition of a particle be liked those separate arms of a branching universe ([15], also see [1]). In fact, H.Everett's interpretation claimed that the state space of particle is a multiverse, or parallel universe ([20]), an application of philosophical law that *the integral always consists of its parts*, or formally, the following.

**Definition 1.1** ([6],[17]-[18]) *Let  $(\Sigma_1; \mathcal{R}_1)$ ,  $(\Sigma_2; \mathcal{R}_2)$ ,  $\dots$ ,  $(\Sigma_m; \mathcal{R}_m)$  be  $m$  mathematical or physical systems, different two by two. A Smarandache multisystem  $\tilde{\Sigma}$  is a union  $\bigcup_{i=1}^m \Sigma_i$  with rules  $\tilde{\mathcal{R}} = \bigcup_{i=1}^m \mathcal{R}_i$  on  $\tilde{\Sigma}$ , denoted by  $(\tilde{\Sigma}; \tilde{\mathcal{R}})$ .*

Furthermore, *things are inherently related, not isolated* in the world. Thus, every particle

in natural is a union of elementary particles underlying a graph embedded in space, where, a graph  $G$  is said to be embeddable into a topological space  $\mathcal{E}$  if there is a 1 – 1 continuous mapping  $f : G \rightarrow \mathcal{E}$  with  $f(p) \neq f(q)$  if  $p \neq q$  for  $\forall p, q \in G$ , i.e., edges only intersect at end vertices in  $\mathcal{E}$ . For example, a *planar graph* such as those shown in Fig.1.

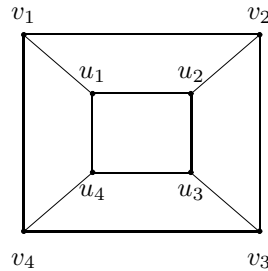

**Fig.1**

**Definition 1.2**([6]) For any integer  $m \geq 1$ , let  $(\tilde{\Sigma}; \tilde{\mathcal{R}})$  be a Smarandache multisystem consisting of  $m$  mathematical systems  $(\Sigma_1; \mathcal{R}_1), (\Sigma_2; \mathcal{R}_2), \dots, (\Sigma_m; \mathcal{R}_m)$ . An inherited topological structures  $G^L [\tilde{\Sigma}; \tilde{\mathcal{R}}]$  on  $(\tilde{\Sigma}; \tilde{\mathcal{R}})$  is defined by

$$V(G^L [\tilde{\Sigma}; \tilde{\mathcal{R}}]) = \{v_{\Sigma_1}, v_{\Sigma_2}, \dots, v_{\Sigma_m}\},$$

$$E(G^L [\tilde{\Sigma}; \tilde{\mathcal{R}}]) = \{(v_{\Sigma_i}, v_{\Sigma_j}) | \Sigma_i \cap \Sigma_j \neq \emptyset, 1 \leq i \neq j \leq m\} \text{ with a labeling}$$

$$L : v_{\Sigma_i} \rightarrow L(v_{\Sigma_i}) = \Sigma_i \quad \text{and} \quad L : (v_{\Sigma_i}, v_{\Sigma_j}) \rightarrow L(v_{\Sigma_i}, v_{\Sigma_j}) = \Sigma_i \cap \Sigma_j,$$

where  $\Sigma_i \cap \Sigma_j$  denotes the intersection of spaces, or action between systems  $\Sigma_i$  with  $\Sigma_j$  for integers  $1 \leq i \neq j \leq m$ .

For example, let  $\tilde{\Sigma} = \Sigma_1 \cup \Sigma_2 \cup \Sigma_3 \cup \Sigma_4$  with  $\Sigma_1 = \{a, b, c\}$ ,  $\Sigma_2 = \{a, b\}$ ,  $\Sigma_3 = \{b, c, d\}$ ,  $\Sigma_4 = \{c, d\}$  and  $\mathcal{R}_i = \emptyset$ . Calculation shows that  $\Sigma_1 \cap \Sigma_2 = \{a, b\}$ ,  $\Sigma_1 \cap \Sigma_3 = \{b, c\}$ ,  $\Sigma_1 \cap \Sigma_4 = \{c\}$ ,  $\Sigma_2 \cap \Sigma_3 = \{b\}$ ,  $\Sigma_2 \cap \Sigma_4 = \emptyset$ ,  $\Sigma_3 \cap \Sigma_4 = \{c, d\}$ . Then, the graph  $G^L [\tilde{\Sigma}; \tilde{\mathcal{R}}]$  is shown in Fig.2.

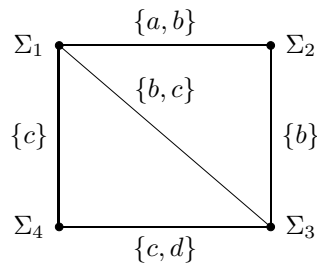

**Fig.2**

Generally, a particle should be characterized by  $(\tilde{\Sigma}; \tilde{\mathcal{R}})$  in theory. However, we can only verify it by some of systems  $(\Sigma_1; \mathcal{R}_1), (\Sigma_2; \mathcal{R}_2), \dots, (\Sigma_m; \mathcal{R}_m)$  for the limitation of human

beings because he is also a system in  $(\tilde{\Sigma}; \tilde{\mathcal{R}})$ . Clearly, the underlying graph in H.Everett's interpretation on wave function is in fact a binary tree and there are many such traces in the developing of physics. For example, a baryon is predominantly formed from three quarks, and a meson is mainly composed of a quark and an antiquark in the models of Sakata, or Gell-Mann and Ne'eman on hadrons ([14]), such as those shown in Fig.3, where,  $q_i \in \{\mathbf{u}, \mathbf{d}, \mathbf{c}, \mathbf{s}, \mathbf{t}, \mathbf{b}\}$  denotes a quark for  $i = 1, 2, 3$  and  $\bar{q}_2 \in \{\bar{\mathbf{u}}, \bar{\mathbf{d}}, \bar{\mathbf{c}}, \bar{\mathbf{s}}, \bar{\mathbf{t}}, \bar{\mathbf{b}}\}$ , an antiquark. Thus, the underlying graphs  $\vec{G}$  of a meson, a baryon are respectively  $\vec{K}_2$  and  $\vec{K}_3$  with actions. In fact, a free quark was not found in experiments until today. So it is only a machinery model on hadrons. Even so, it characterizes well the known behavior of particles.

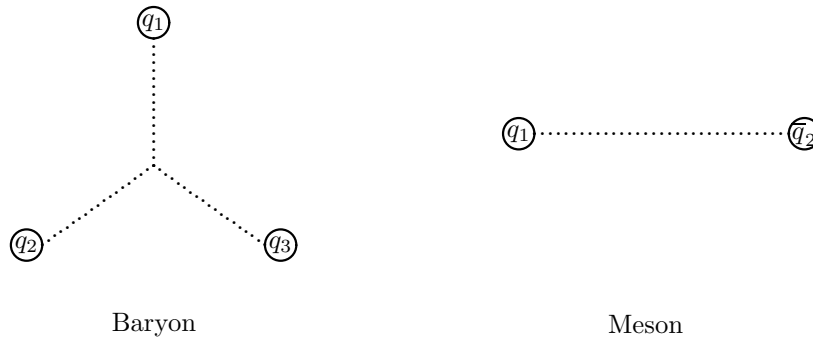

**Fig.3**

It should be noted that the geometry on Definition 1.1 – 1.2 can be also used to characterize particles by combinatorial fields ([7]), and there is a priori assumption for discussion in physics, namely, *the dynamical equation of a subparticle of a particle is the same of that particle*. For example, the dynamical equation of quark is nothing else but the Dirac equation (1.3), a characterizing on quark from the macroscopic to the microscopic, the quantum level in physics. However, the equation (1.3) can not provides such a solution on the behaviors of 3 quarks. We can only interpret it similar to that of H.Everett, i.e., there are 3 parallel equations (1.3) in discussion, a seemly rational interpretation in physics, but not perfect for mathematics. Why this happens is because the interpretation of solution of equation. Usually, we identify a particle to the solution of its equation, i.e., if the variables  $t$  and  $x_1, x_2, x_3$  hold with a system of dynamical equations

$$\mathcal{F}_i(t, x_1, x_2, x_3, u_t, u_{x_1}, \dots, u_{x_1 x_2}, \dots) = 0, \quad 1 \leq i \leq m, \quad (DEq_m^A)$$

the particle in  $\mathbb{R} \times \mathbb{R}^3$  is a point  $(t, x_1, x_2, x_3)$ , and if more than one points  $(t, x_1, x_2, x_3)$  hold with  $(ESq_m^A)$ , the particle is nothing else but consisting of all such points. However, the solutions of equations (1.1)-(1.3) are all definite on time  $t$ . *Is this interpretation can be used for particles in all times?* Certainly not because a particle can be always decomposed into elementary particles, and it is a little ambiguous which is a point, the particle itself or its one of elementary particles sometimes.

This speculation naturally leads to a question on mathematics, i.e., *what is the right in-*

*terpretation on the solution of differential equation accompanying with particles?* Recently, the author extended Banach spaces on topological graphs  $\vec{G}$  with operator actions in [13], and shown all of these extensions are also Banach space, particularly, the Hilbert space with unique correspondence in elements on linear continuous functionals, which enables one to solve linear functional equations in such extended space, particularly, solve differential equations on a topological graph, i.e., find multiverse solutions for equations. This scheme also enables us to interpret the superposition of particles in accordance with mathematics in logic.

The main purpose of this paper is to present an interpretation on superposition of particles by  $\vec{G}$ -flow solutions of equations (1.1)-(1.3) in accordance with mathematics. Certainly, the geometry on non-solvable differential equations discussed in [9]-[12] brings us another general way for holding behaviors of particles in mathematics. For terminologies and notations not mentioned here, we follow references [16] for elementary particles, [6] for geometry and topology, and [17]-[18] for Smarandache multi-spaces, and all equations are assumed to be solvable in this paper.

## §2. Extended Banach $\vec{G}$ -Flow Spaces

### 2.1 Conservation Laws

A conservation law, such as those on energy, mass, momentum, angular momentum and conservation of electric charge states that a particular measurable property of an isolated physical system does not change as the system evolves over time, or simply, constant of being. Usually, a local conservation law is expressed mathematically as a continuity equation, which states that the amount of the conserved quantity at a point or within a volume can only change by the amount of the quantity which flows in or out of the volume. According to Definitions 1.1 and 1.2, a matter in the nature is nothing else but a Smarandache system  $(\tilde{\Sigma}; \tilde{\mathcal{R}})$ , or a topological graph  $G^L \left[ (\tilde{\Sigma}; \tilde{\mathcal{R}}) \right]$  embedded in  $\mathbb{R}^3$ , hold with conservation laws

$$\sum_k \mathbf{F}(\mathbf{v})_k^- = \sum_l \mathbf{F}(\mathbf{v})_l^+$$

on  $\forall v \in V \left( G^L \left[ (\tilde{\Sigma}; \tilde{\mathcal{R}}) \right] \right)$ , where,  $\mathbf{F}(\mathbf{v})_k^-$ ,  $k \geq 1$  and  $\mathbf{F}(\mathbf{v})_l^+$ ,  $l \geq 1$  denote respectively the input or output amounts on a particle or a volume  $v$ .

### 2.2 $\vec{G}$ -Flow Spaces

Classical operation systems can be easily extended on a graph  $\vec{G}$  constraint on conditions for characterizing the unanimous behaviors of groups in the nature, particularly, go along with the physics. For this objective, let  $\vec{G}$  be an oriented graph with vertex set  $V(G)$  and arc set  $X(G)$  embedded in  $\mathbb{R}^3$  and let  $(\mathcal{A}; \circ)$  be an operation system in classical mathematics, i.e., for  $\forall a, b \in \mathcal{A}$ ,  $a \circ b \in \mathcal{A}$ . Denoted by  $\vec{G}_{\mathcal{A}}^L$  all of those labeled graphs  $\vec{G}^L$  with labeling  $L: X(\vec{G}) \rightarrow \mathcal{A}$ . Then, we can extend operation  $\circ$  on elements in  $\vec{G}_{\mathcal{A}}^L$  by a ruler following:



**R**: For  $\forall \vec{G}^{L_1}, \vec{G}^{L_2} \in \vec{G}_{\mathcal{A}}^L$ , define  $\vec{G}^{L_1} \circ \vec{G}^{L_2} = \vec{G}^{L_1 \circ L_2}$ , where  $L_1 \circ L_2 : e \rightarrow L_1(e) \circ L_2(e)$  for  $\forall e \in X(\vec{G})$ .

For example, such an extension on graph  $\vec{C}_4$  is shown in Fig.4, where,  $\mathbf{a}_3 = \mathbf{a}_1 \circ \mathbf{a}_2$ ,  $\mathbf{b}_3 = \mathbf{b}_1 \circ \mathbf{b}_2$ ,  $\mathbf{c}_3 = \mathbf{c}_1 \circ \mathbf{c}_2$ ,  $\mathbf{d}_3 = \mathbf{d}_1 \circ \mathbf{d}_2$ .

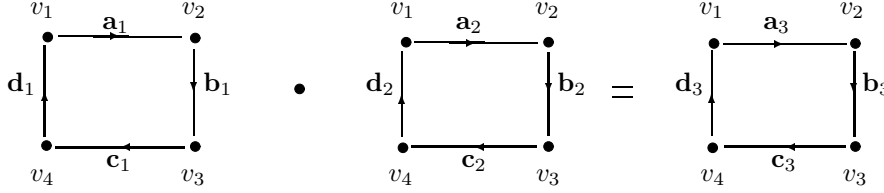

Fig.4

Clearly,  $\vec{G}^{L_1} \circ \vec{G}^{L_2} \in \vec{G}_{\mathcal{A}}^L$  by definition, i.e.,  $\vec{G}_{\mathcal{A}}^L$  is also an operation system under ruler **R**, and it is commutative if  $(\mathcal{A}, \circ)$  is commutative,

Furthermore, if  $(\mathcal{A}, \circ)$  is an algebraic group,  $\vec{G}_{\mathcal{A}}^L$  is also an algebraic group because

(1)  $(\vec{G}^{L_1} \circ \vec{G}^{L_2}) \circ \vec{G}^{L_3} = \vec{G}^{L_1} \circ (\vec{G}^{L_2} \circ \vec{G}^{L_3})$  for  $\forall \vec{G}^{L_1}, \vec{G}^{L_2}, \vec{G}^{L_3} \in \vec{G}_{\mathcal{A}}^L$  because  $(L_1(e) \circ L_2(e)) \circ L_3(e) = L_1(e) \circ (L_2(e) \circ L_3(e))$  for  $e \in X(\vec{G})$ , i.e.,  $\vec{G}^{(L_1 \circ L_2) \circ L_3} = \vec{G}^{L_1 \circ (L_2 \circ L_3)}$ .

(2) there is an identify  $\vec{G}^{L_{1_{\mathcal{A}}}}$  in  $\vec{G}_{\mathcal{A}}^L$ , where  $L_{1_{\mathcal{A}}} : e \rightarrow 1_{\mathcal{A}}$  for  $\forall e \in X(\vec{G})$ ;

(3) there is an uniquely element  $\vec{G}^{L^{-1}}$  for  $\forall \vec{G}^L \in \vec{G}_{\mathcal{A}}^L$ .

However, for characterizing the unanimous behaviors of groups in the nature, the most useful one is the extension of vector space  $(\mathcal{V}; +, \cdot)$  over field  $\mathcal{F}$  by defining the operations  $+$  and  $\cdot$  on elements in  $\vec{G}^{\mathcal{V}}$  such as those shown in Fig.5 on graph  $\vec{C}_4$ , where  $\mathbf{a}, \mathbf{b}, \mathbf{c}, \mathbf{d}, \mathbf{a}_i, \mathbf{b}_i, \mathbf{c}_i, \mathbf{d}_i \in \mathcal{V}$  for  $i = 1, 2, 3$ ,  $\mathbf{x}_3 = \mathbf{x}_1 + \mathbf{x}_2$  for  $\mathbf{x} = \mathbf{a}, \mathbf{b}, \mathbf{c}$  or  $\mathbf{d}$  and  $\alpha \in \mathcal{F}$ .

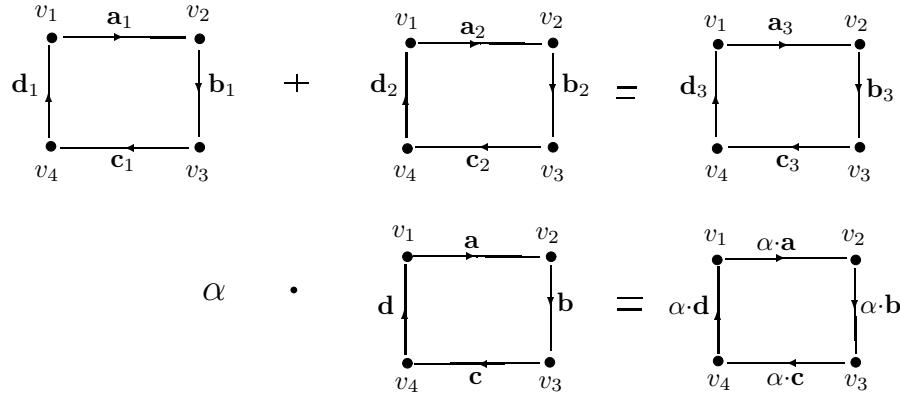

Fig.5

A  $\vec{G}$ -flow on  $\vec{G}$  is such an extension hold with  $L(u, v) = -L(v, u)$  and conservation laws

$$\sum_{u \in N_G(v)} L(v, u) = \mathbf{0}$$

for  $\forall v \in V(\vec{G})$ , where  $\mathbf{0}$  is the zero-vector in  $\mathcal{V}$ . Thus, a  $\vec{G}$ -flow is a subfamily of  $\vec{G}_{\mathcal{V}}^L$  limited by conservation laws. For example, if  $\vec{G} = \vec{C}_4$ , there must be  $\mathbf{a}=\mathbf{b}=\mathbf{c}=\mathbf{d}$  and  $\mathbf{a}_i=\mathbf{b}_i=\mathbf{c}_i=\mathbf{d}_i$  for  $i = 1, 2, 3$  in Fig.5.

Clearly, all conservation  $\vec{G}$ -flows on  $\vec{G}$  also form a vector space over  $\mathcal{F}$  under operations  $+$  and  $\cdot$  with zero vector  $\mathbf{O} = \vec{G}^{L_0}$ , where  $L_0 : e \rightarrow \mathbf{0}$  for  $\forall e \in X(\vec{G})$ . Such an extended vector space on  $\vec{G}$  is denoted by  $\vec{G}^{\mathcal{V}}$ .

Furthermore, if  $(\mathcal{V}; +, \cdot)$  is a Banach or Hilbert space with inner product  $\langle \cdot, \cdot \rangle$ , we can also introduce the *norm* and *inner product* on  $\vec{G}^{\mathcal{V}}$  by

$$\|\vec{G}^L\| = \sum_{(u,v) \in X(\vec{G})} \|L(u,v)\|$$

or

$$\langle \vec{G}^{L_1}, \vec{G}^{L_2} \rangle = \sum_{(u,v) \in X(\vec{G})} \langle L_1(u,v), L_2(u,v) \rangle$$

for  $\forall \vec{G}^L, \vec{G}^{L_1}, \vec{G}^{L_2} \in \vec{G}^{\mathcal{V}}$ , where  $\|L(u,v)\|$  is the norm of  $L(u,v)$  in  $\mathcal{V}$ . Then it can be verified that

- (1)  $\|\vec{G}^L\| \geq 0$  and  $\|\vec{G}^L\| = 0$  if and only if  $\vec{G}^L = \mathbf{O}$ ;
- (2)  $\|\vec{G}^{\xi L}\| = \xi \|\vec{G}^L\|$  for any scalar  $\xi$ ;
- (3)  $\|\vec{G}^{L_1} + \vec{G}^{L_2}\| \leq \|\vec{G}^{L_1}\| + \|\vec{G}^{L_2}\|$ ;
- (4)  $\langle \vec{G}^L, \vec{G}^L \rangle = \sum_{(u,v) \in X(\vec{G})} \langle L(u^v), L(u^v) \rangle \geq 0$  and  $\langle \vec{G}^L, \vec{G}^L \rangle = 0$  if and only if  $\vec{G}^L = \mathbf{O}$ ;

**O**;

- (5)  $\langle \vec{G}^{L_1}, \vec{G}^{L_2} \rangle = \overline{\langle \vec{G}^{L_2}, \vec{G}^{L_1} \rangle}$  for  $\forall \vec{G}^{L_1}, \vec{G}^{L_2} \in \vec{G}^{\mathcal{V}}$ ;
- (6) For  $\vec{G}^L, \vec{G}^{L_1}, \vec{G}^{L_2} \in \vec{G}^{\mathcal{V}}$  and  $\lambda, \mu \in \mathcal{F}$ ,

$$\langle \lambda \vec{G}^{L_1} + \mu \vec{G}^{L_2}, \vec{G}^L \rangle = \lambda \langle \vec{G}^{L_1}, \vec{G}^L \rangle + \mu \langle \vec{G}^{L_2}, \vec{G}^L \rangle.$$

The following result is known by showing that any Cauchy sequence in  $\vec{G}^{\mathcal{V}}$  is converges hold with conservation laws.

**Theorem 2.1**([13]) *For any topological graph  $\vec{G}$ ,  $\vec{G}^{\mathcal{V}}$  is a Banach space, and furthermore, if  $\mathcal{V}$  is a Hilbert space,  $\vec{G}^{\mathcal{V}}$  is a Hilbert space also.*

According to Theorem 2.1, the operators action on Banach or Hilbert space  $(\mathcal{V}; +, \cdot)$  can be extended on  $\vec{G}^{\mathcal{V}}$ , for example, the linear operator following.

**Definition 2.2** *An operator  $\mathbf{T} : \vec{G}^{\mathcal{V}} \rightarrow \vec{G}^{\mathcal{V}}$  is linear if*

$$\mathbf{T}(\lambda \vec{G}^{L_1} + \mu \vec{G}^{L_2}) = \lambda \mathbf{T}(\vec{G}^{L_1}) + \mu \mathbf{T}(\vec{G}^{L_2})$$

for  $\forall \vec{G}^{L_1}, \vec{G}^{L_2} \in \vec{G}^{\mathcal{V}}$  and  $\lambda, \mu \in \mathcal{F}$ , and is continuous at a  $\vec{G}$ -flow  $\vec{G}^{L_0}$  if there always exist a number  $\delta(\varepsilon)$  for  $\forall \varepsilon > 0$  such that

$$\left\| \mathbf{T}(\vec{G}^L) - \mathbf{T}(\vec{G}^{L_0}) \right\| < \varepsilon \quad \text{if} \quad \left\| \vec{G}^L - \vec{G}^{L_0} \right\| < \delta(\varepsilon).$$

The following interesting result generalizes the result of Fréchet and Riesz on linear continuous functionals, which opens us mind for applying  $\vec{G}$ -flows to hold on the nature.

**Theorem 2.3**([13]) *Let  $\mathbf{T} : \vec{G}^{\mathcal{V}} \rightarrow \mathbb{C}$  be a linear continuous functional. Then there is a unique  $\vec{G}^{\hat{L}} \in \vec{G}^{\mathcal{V}}$  such that*

$$\mathbf{T}(\vec{G}^L) = \langle \vec{G}^L, \vec{G}^{\hat{L}} \rangle$$

for  $\forall \vec{G}^L \in \vec{G}^{\mathcal{V}}$ .

Particularly, if all flows  $L(u, v)$  on arcs  $(u, v)$  of  $\vec{G}$  are state function, we extend the differential operator on  $\vec{G}$ -flows. In fact, a differential operator  $\frac{\partial}{\partial t}$  or  $\frac{\partial}{\partial x_i} : \vec{G}^{\mathcal{V}} \rightarrow \vec{G}^{\mathcal{V}}$  is defined by

$$\frac{\partial}{\partial t} : \vec{G}^L \rightarrow \vec{G}^{\frac{\partial L}{\partial t}}, \quad \frac{\partial}{\partial x_i} : \vec{G}^L \rightarrow \vec{G}^{\frac{\partial L}{\partial x_i}}$$

for integers  $1 \leq i \leq 3$ . Then, for  $\forall \mu, \lambda \in \mathcal{F}$ ,

$$\begin{aligned} \frac{\partial}{\partial t} (\lambda \vec{G}^{L_1} + \mu \vec{G}^{L_2}) &= \frac{\partial}{\partial t} (\vec{G}^{\lambda L_1 + \mu L_2}) = \vec{G}^{\frac{\partial}{\partial t}(\lambda L_1 + \mu L_2)} \\ &= \vec{G}^{\frac{\partial}{\partial t}(\lambda L_1) + \frac{\partial}{\partial t}(\mu L_2)} = \vec{G}^{\frac{\partial}{\partial t}(\lambda L_1)} + \vec{G}^{\frac{\partial}{\partial t}(\mu L_2)} \\ &= \frac{\partial}{\partial t} \vec{G}^{(\lambda L_1)} + \frac{\partial}{\partial t} \vec{G}^{(\mu L_2)} = \lambda \frac{\partial}{\partial t} \vec{G}^{L_1} + \mu \frac{\partial}{\partial t} \vec{G}^{L_2}, \end{aligned}$$

i.e.,

$$\frac{\partial}{\partial t} (\lambda \vec{G}^{L_1} + \mu \vec{G}^{L_2}) = \lambda \frac{\partial}{\partial t} \vec{G}^{L_1} + \mu \frac{\partial}{\partial t} \vec{G}^{L_2}.$$

Similarly, we know also that

$$\frac{\partial}{\partial x_i} (\lambda \vec{G}^{L_1} + \mu \vec{G}^{L_2}) = \lambda \frac{\partial}{\partial x_i} \vec{G}^{L_1} + \mu \frac{\partial}{\partial x_i} \vec{G}^{L_2}$$

for integers  $1 \leq i \leq 3$ . Thus, operators  $\frac{\partial}{\partial t}$  and  $\frac{\partial}{\partial x_i}$ ,  $1 \leq i \leq 3$  are all linear on  $\vec{G}^{\mathcal{V}}$ .

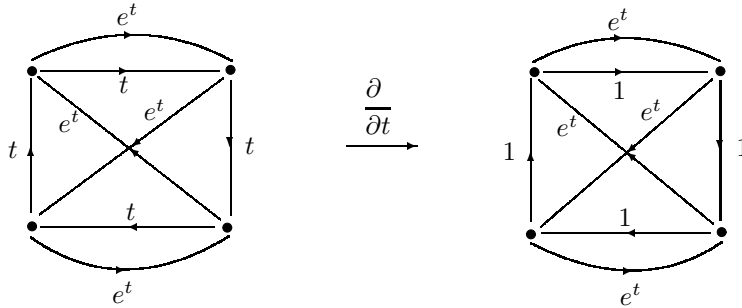

**Fig.6**

Similarly, we introduce *integral operator*  $\int : \vec{G}^\mathcal{V} \rightarrow \vec{G}^\mathcal{V}$  by

$$\int : \vec{G}^L \rightarrow \vec{G}^{\int L dt}, \quad \vec{G}^L \rightarrow \vec{G}^{\int L dx_i}$$

for integers  $1 \leq i \leq 3$  and know that

$$\int (\mu \vec{G}^{L_1} + \lambda \vec{G}^{L_2}) = \mu \int (\vec{G}^{L_1}) + \lambda \int (\vec{G}^{L_2})$$

for  $\forall \mu, \lambda \in \mathcal{F}$ ,

$$\int \circ \left( \frac{\partial}{\partial t} \right) \text{ and } \int \circ \left( \frac{\partial}{\partial x_i} \right) : \vec{G}^L \rightarrow \vec{G}^L + \vec{G}^{L_c},$$

where  $L_c$  is such a labeling that  $L_c(u, v)$  is constant for  $\forall (u, v) \in X(\vec{G})$ .

### §3. Particle Equations in $\vec{G}$ -Flow Space

We are easily find particle equations with nonrelativistic or relativistic mechanics in  $\vec{G}^\mathcal{V}$ . Notice that

$$i\hbar \frac{\partial \psi}{\partial t} = E\psi, \quad -i\hbar \nabla \psi = \vec{p}^2 \psi$$

and

$$E = \frac{1}{2m} \vec{p}^2 + U,$$

in classical mechanics, where  $\psi$  is the state function,  $E, \vec{p}, U$  are respectively the energy, the momentum, the potential energy and  $m$  the mass of the particle. Whence,

$$\begin{aligned} \mathbf{0} &= \vec{G}^{(E - \frac{1}{2m} \vec{p}^2 - U)\psi} = \vec{G}^{E\psi} - \vec{G}^{\frac{1}{2m} \vec{p}^2 \psi} - \vec{G}^{U\psi} \\ &= \vec{G}^{i\hbar \frac{\partial \psi}{\partial t}} - \vec{G}^{-\frac{\hbar}{2m} \nabla^2 \psi} - \vec{G}^{U\psi} = i\hbar \frac{\partial \vec{G}^{L_\psi}}{\partial t} + \frac{\hbar}{2m} \nabla^2 \vec{G}^{L_\psi} - \vec{G}^{L_U} \vec{G}^{L_\psi}, \end{aligned}$$

where  $L_\psi : e \rightarrow$  state function and  $L_U : e \rightarrow$  potential energy on  $e \in X(\vec{G})$ . According to the conservation law of energy, there must be  $\vec{G}^U \in \vec{G}^\mathcal{V}$ . We get the Schrödinger equation in  $\vec{G}^\mathcal{V}$  following.

$$-i\hbar \frac{\partial \vec{G}^{L_\psi}}{\partial t} = \frac{\hbar}{2m} \nabla^2 \vec{G}^{L_\psi} - \widehat{U} \vec{G}^{L_\psi}, \quad (3.1)$$

where  $\widehat{U} = \vec{G}^{L_U} \in \vec{G}^\mathcal{V}$ . Similarly, by the relativistic energy-momentum relation

$$E^2 = c^2 \vec{p}^2 + m^2 c^4$$

for bosons and

$$E = c\alpha_k \vec{p}_k + \alpha_0 m c^2$$



with  $a_{ij}, b_j \in \mathcal{F}$  for integers  $1 \leq i \leq n, 1 \leq j \leq m$  holding with

$$\text{rank} [a_{ij}]_{m \times n} = \text{rank} [a_{ij}]_{m \times (n+1)}^+$$

has  $\vec{G}$ -flow solutions on infinitely many topological graphs  $\vec{G}$ , where

$$[a_{ij}]_{m \times (n+1)}^+ = \begin{bmatrix} a_{11} & a_{12} & \cdots & a_{1n} & L_1 \\ a_{21} & a_{22} & \cdots & a_{2n} & L_2 \\ \cdots & \cdots & \cdots & \cdots & \cdots \\ a_{m1} & a_{m2} & \cdots & a_{mn} & L_m \end{bmatrix}.$$

We can also get  $\vec{G}$ -flow solutions for linear partial differential equations ([14]). For example, the Cauchy problems on differential equations

$$\frac{\partial X}{\partial t} = c^2 \sum_{i=1}^n \frac{\partial^2 X}{\partial x_i^2}$$

with initial value  $X|_{t=t_0} = \vec{G}^{L'} \in \vec{G}^{\mathcal{V}}$  is also solvable in  $\vec{G}^{\mathcal{V}}$  if  $L'(u, v)$  is continuous and bounded in  $\mathbb{R}^n$  for  $\forall (u, v) \in X(\vec{G})$  and  $\forall \vec{G}^{L'} \in \vec{G}^{\mathcal{V}}$ . In fact,  $X = \vec{G}^{L_F}$  with  $L_F : (u, v) \rightarrow F(u, v)$  for  $\forall (u, v) \in X(\vec{G})$ , where

$$F(u, v) = \frac{1}{(4\pi t)^{\frac{n}{2}}} \int_{-\infty}^{+\infty} e^{-\frac{(x_1-y_1)^2 + \cdots + (x_n-y_n)^2}{4t}} L'(u, v)(y_1, \cdots, y_n) dy_1 \cdots dy_n$$

is such a solution.

Generally, if  $\vec{G}$  can be decomposed into circuits  $\vec{C}$ , the next result concludes that we can always find  $\vec{G}$ -flow solutions on equations, no matter what the equation looks like, linear or non-linear ([13]).

**Theorem 4.2** *If the topological graph  $\vec{G}$  is strong-connected with circuit decomposition*

$$\vec{G} = \bigcup_{i=1}^l \vec{C}_i$$

such that  $L(u, v) = L_i(\mathbf{x})$  for  $\forall (u, v) \in X(\vec{C}_i), 1 \leq i \leq l$  and the Cauchy problem

$$\begin{cases} \mathcal{F}_i(\mathbf{x}, u, u_{x_1}, \cdots, u_{x_n}, u_{x_1 x_2}, \cdots) = 0 \\ u|_{x_0} = L_i(\mathbf{x}) \end{cases}$$

is solvable in a Hilbert space  $\mathcal{V}$  on domain  $\Delta \subset \mathbb{R}^n$  for integers  $1 \leq i \leq l$ , then the Cauchy

problem

$$\begin{cases} \mathcal{F}_i(\mathbf{x}, X, X_{x_1}, \dots, X_{x_n}, X_{x_1 x_2}, \dots) = 0 \\ X|_{x_0} = \vec{G}^L \end{cases}$$

such that  $L(u, v) = L_i(\mathbf{x})$  for  $\forall (u, v) \in X(\vec{C}_i)$  is solvable for  $X \in \vec{G}^\nu$ .

In fact, such a solution is constructed by  $X = \vec{G}^{L_{u(\mathbf{x})}}$  with  $L_{u(\mathbf{x})}(u, v) = u(\mathbf{x})$  for  $(u, v) \in X(\vec{G})$  by applying the input and the output at vertex  $v$  all being  $u(\mathbf{x})$  on  $\vec{C}$ , which implies that all flows at vertex  $v \in V(\vec{G})$  is conserved.

### 4.2 $\vec{G}$ -Flow Solutions on Particle Equation

The existence of  $\vec{G}$ -flow solutions on particle equations (1.1)-(1.3) is clearly concluded by Theorem 4.2, also implied by equations (3.1)-(3.3) for any  $\vec{G}$ . However, the superposition of a particle  $P$  shows that there are  $N \geq 2$  states of being associated with a particle  $P$ . Considering this fact, a convenient  $\vec{G}$ -flow model for elementary particle fermions, the lepton or quark  $P$  is by a bouquet  $\vec{B}_N^{L_\psi}$ , and an antiparticle  $\bar{P}$  of  $P$  presented by  $\vec{B}_N^{L_{\psi^{-1}}}$  with all inverse state functions on its loops, such as those shown in Fig.8.

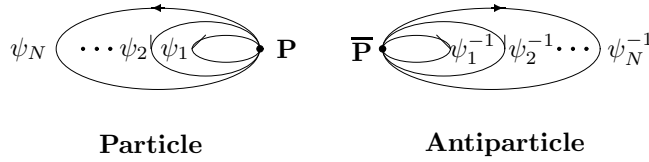

Fig.8

Similarly, an elementary unparticle is an intermediate form between an elementary particle and its antiparticle, which can be presented by  $\vec{B}_N^{L_\psi^C}$ , where  $L_\psi^C : e \rightarrow L_{\psi^{-1}}(e)$  if  $e \in C$  but  $L_\psi^C : e \rightarrow L_\psi(e)$  if  $e \in X(\vec{B}_N) \setminus C$  for a subset  $C \subset X(\vec{B}_N)$ .

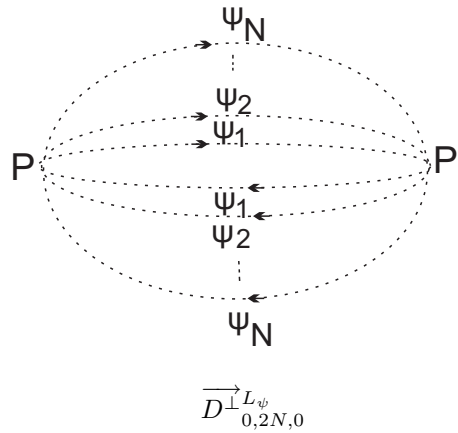

Fig.9

Thus, an elementary particle with its antiparticles maybe annihilate or appears in pair at a time, and unparticles are constructed by combinations of these state functions with their inverses on the particle, and the mediate interaction particles quanta, i.e., boson by dipole  $\vec{D}_{0,2N,0}^{\perp L\psi}$  with dotted lines, such as those shown in Fig.9, where, the vertex  $P, P'$  denotes particles, and arcs with state functions  $\psi_1, \psi_2, \dots, \psi_N$  are the  $N$  states of  $P$ . Notice that  $\vec{B}_N^{L\psi}$  and  $\vec{D}_{0,2N,0}^{\perp L\psi}$  both are a union of  $N$  circuits. According to Theorem 4.2, we consequently get the following conclusion.

**Theorem 4.3** For any integer  $N \geq 1$ , there are indeed  $\vec{D}_{0,2N,0}^{\perp L\psi}$ -flow solution on Klein-Gordon equation (1.2), and  $\vec{B}_N^{L\psi}$ -flow solution on Dirac equation (1.3).

Generally, this model enables us to know that the  $\vec{G}$ -flow constituents of a particle also. Thus, if a particle  $\tilde{P}$  is consisted of  $l$  elementary particles  $P_1, P_1, \dots, P_l$  underlying a graph  $\vec{G}[\tilde{P}]$ , its  $\vec{G}$ -flow is obtained by replace each vertex  $v$  by  $\vec{B}_{N_v}^{L\psi_v}$  and each arc  $e$  by  $\vec{D}_{0,2N_e,0}^{\perp L\psi_e}$  in  $\vec{G}[\tilde{P}]$ , denoted by  $\vec{G}^{L\psi}[\vec{B}_v, \vec{D}_e]$ .

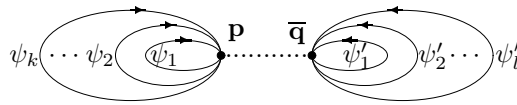

Fig.10 Meson

For example, the model of Sakata, or Gell-Mann and Ne'eman on hadrons claims the meson and the baryon are respectively the dipole  $\vec{D}_{k,2N,l}^{\perp L\psi_e}$ -flow shown in Fig.10 and the triplet  $\vec{G}$ -flow  $\vec{C}_{k,l,s}^{\perp L\psi}$  shown in Fig.11,

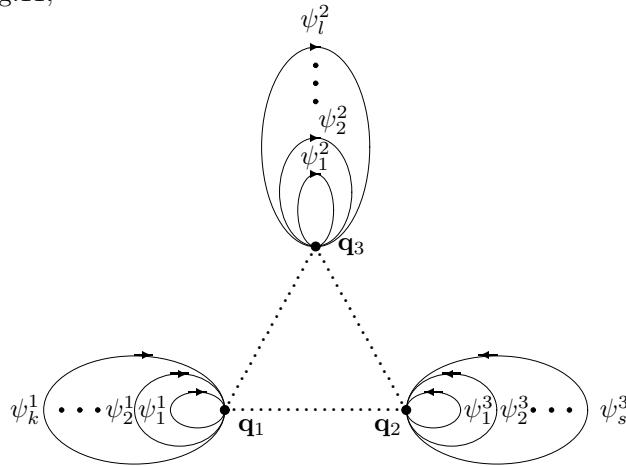

Fig.11 Baryon



where, the dotted lines denote the dipole  $\overrightarrow{D}_{0,2N_e,0}^{\perp L\psi_e}$ -flows,  $\mathbf{p}, \mathbf{q}_1, \mathbf{q}_2, \mathbf{q}_3$  are quarks,  $\overline{\mathbf{q}}$  an antiquark and integers  $k, l, s \geq 1$ .

For a constructed  $\overrightarrow{G}$ -flow  $\overrightarrow{G}^{L\psi} [\overrightarrow{B}_v, \overrightarrow{D}_e]$ , its size index  $\lambda_G$  is determined by

$$\lambda_G = \sum_{v \in V(\overrightarrow{G})} N_v + \sum_{e \in X(\overrightarrow{G})} N_e,$$

which is in fact the number of states in  $P$ .

**Theorem 4.4** *If  $\tilde{P}$  is a particle consisted of elementary particles  $P_1, P_1, \dots, P_l$ , then  $\overrightarrow{G}^{L\psi} [\overrightarrow{B}_v, \overrightarrow{D}_e]$  is a  $\overrightarrow{G}$ -flow solution on the Schrödinger equation (1.1) whenever  $\lambda_G$  is finite or infinite.*

*Proof* If  $\lambda_G$  is finite, the conclusion follows Theorem 4.2 immediately. We only consider the case of  $\lambda_G \rightarrow \infty$ . In fact, if  $\lambda_G \rightarrow \infty$ , calculation shows that

$$\begin{aligned} i\hbar \lim_{\lambda_G \rightarrow \infty} \left( \frac{\partial}{\partial t} \left( \overrightarrow{G}^{L\psi} [\overrightarrow{B}_v, \overrightarrow{D}_e] \right) \right) &= \lim_{\lambda_G \rightarrow \infty} \left( i\hbar \frac{\partial}{\partial t} \left( \overrightarrow{G}^{L\psi} [\overrightarrow{B}_v, \overrightarrow{D}_e] \right) \right) \\ &= \lim_{\lambda_G \rightarrow \infty} \left( -\frac{\hbar^2}{2m} \nabla^2 \overrightarrow{G}^{L\psi} [\overrightarrow{B}_v, \overrightarrow{D}_e] + \overrightarrow{G}^{L\psi} \right) \\ &= -\frac{\hbar^2}{2m} \nabla^2 \lim_{\lambda_G \rightarrow \infty} \overrightarrow{G}^{L\psi} [\overrightarrow{B}_v, \overrightarrow{D}_e] + \overrightarrow{G}^{L\psi}, \end{aligned}$$

i.e.,

$$i\hbar \lim_{\lambda_G \rightarrow \infty} \left( \frac{\partial}{\partial t} \left( \overrightarrow{G}^{L\psi} [\overrightarrow{B}_v, \overrightarrow{D}_e] \right) \right) = -\frac{\hbar^2}{2m} \nabla^2 \lim_{\lambda_G \rightarrow \infty} \overrightarrow{G}^{L\psi} [\overrightarrow{B}_v, \overrightarrow{D}_e] + \overrightarrow{G}^{L\psi}.$$

Particularly,

$$\begin{aligned} i\hbar \lim_{N \rightarrow \infty} \left( \frac{\partial \overrightarrow{B}_N^{L\psi}}{\partial t} \right) &= -\frac{\hbar^2}{2m} \nabla^2 \lim_{N \rightarrow \infty} \overrightarrow{B}_N^{L\psi} + \overrightarrow{G}^{L\psi}, \\ i\hbar \lim_{N \rightarrow \infty} \frac{\partial}{\partial t} \left( \overrightarrow{D}_{0,2N,0}^{\perp L\psi} \right) &= -\frac{\hbar^2}{2m} \nabla^2 \lim_{N \rightarrow \infty} \overrightarrow{D}_{0,2N,0}^{\perp L\psi} + \overrightarrow{G}^{L\psi}. \end{aligned}$$

for bouquets and dipoles. □

## §5. $\overrightarrow{G}$ -Flow Interpretation on Particle Superposition

The superposition of a particle  $P$  is depicted by a Hilbert space  $\mathcal{V}$  over complex field  $\mathbb{C}$  with orthogonal basis  $|1\rangle, |2\rangle, \dots, |n\rangle, \dots$  in quantum mechanics. In fact, the linearity of Schrödinger equation concludes that all states of particle  $P$  are in such a space. However, an observer can grasp only one state, which promoted H.Everett devised a multiverse consisting of states in splitting process, i.e., the quantum effects spawn countless branches of the universe with different events occurring in each, not influence one another, such as those shown in Fig.12,

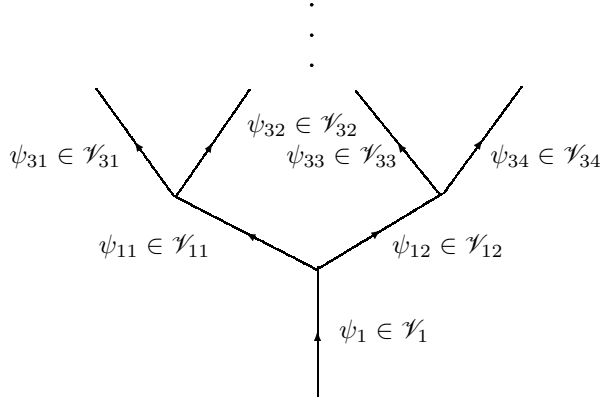

**Fig.12**

and the observer selects by randomness, where the multiverse is  $\bigcup_{i \geq 1} \mathcal{V}_i$  with  $\mathcal{V}_{kl} = \mathcal{V}$  for integers  $k \geq 1, 1 \leq l \leq 2^k$  but in different positions.

Why it needs an interpretation on particle superposition in physics lies in that we characterize the behavior of particle by dynamic equation on state function and interpret it to be the solutions, and different quantum state holds with different solution of that equation. However, we can only get one solution by solving the equation with given initial datum once, and hold one state of the particle  $P$ , i.e., the solution correspondent only to one position but the particle is in superposition, which brought the H.Everett interpretation on superposition. It is only a biological mechanism by infinite parallel spaces  $\mathcal{V}$  but loses of conservations on energy or matter in the nature, whose independently runs also overlook the existence of universal connection in things, a philosophical law.

Even so, it can not blot out the ideological contribution of H.Everett to sciences a shred because all of these mentions are produced by the interpretation on mathematical solutions with the reality of things, i.e., scanning on local, not the global. However, if we extend the Hilbert space  $\mathcal{V}$  to  $\vec{B}_N^{L_\psi}, \vec{D}_{0,2N,0}^{L_\psi}$  or  $\vec{G}^{L_\psi} [\vec{B}_v, \vec{D}_e]$  in general, i.e.,  $\vec{G}$ -flow space  $\vec{G}^\mathcal{V}$ , where  $\vec{G}$  is the underling topological graph of  $P$ , the situation has been greatly changed because  $\vec{G}^\mathcal{V}$  is itself a Hilbert space, and we can identify the  $\vec{G}$ -flow on  $\vec{G}$  to particle  $P$ , i.e.,

$$P = \vec{G}^{L_\psi} [\vec{B}_v, \vec{D}_e] \tag{5.1}$$

for a globally understanding the behaviors of particle  $P$  whatever  $\lambda_G \rightarrow \infty$  or not by Theorem 4.4. For example, let  $P = \vec{B}_N^{L_\psi}$ , i.e., a free particle such as those of electron  $e^-$ , muon  $\mu^-$ , tauon  $\tau^-$ , or their neutrinos  $\nu_e, \nu_\mu, \nu_\tau$ . Then the superposition of  $P$  is displayed by state functions  $\psi$  on  $N$  loops in  $\vec{B}_N$  hold on its each loop with

$$\text{input } \psi_i = \text{ouput } \psi_i \text{ at vertex } P$$

for integers  $1 \leq i \leq N$ . Consequently,

$$\text{input } \sum_{i \in I} \psi_i = \text{output } \sum_{i \in I} \psi_i \text{ at vertex } P \quad (5.2)$$

for  $\forall I \subset \{1, 2, \dots, N\}$ , the conservation law on vertex  $P$ . Furthermore, such a  $\vec{B}_N^{L\psi}$  is not only a disguise on  $P$  in form but also a really mathematical element in Hilbert space  $\vec{B}^{\mathcal{V}}$ , and can be also used to characterize the behavior of particles such as those of the decays or collisions of particles by graph operations. For example, the  $\beta$ -decay  $n \rightarrow p + e^- + \mu_e^-$  is transferred to a decomposition formula

$$\vec{C}_{k,l,s}^{\perp L\psi n} = \vec{C}_{k_1,l_1,s_1}^{\perp L\psi p} \cup \vec{B}_{N_1}^{L\psi e} \cup \vec{B}_{N_2}^{L\psi \mu},$$

on graph, where,  $\vec{C}_{k_1,l_1,s_1}^{\perp L\psi p}$ ,  $\vec{B}_{N_1}^{L\psi e}$ ,  $\vec{B}_{N_2}^{L\psi \mu}$  are all subgraphs of  $\vec{C}_{k,l,s}^{\perp L\psi n}$ . Similarly, the  $\beta$ -collision  $\nu_e + p \rightarrow n + e^+$  is transferred to an equality

$$\vec{B}_{N_1}^{L\psi \nu_e} \cup \vec{C}_{k_1,l_1,s_1}^{\perp L\psi p} = \vec{C}_{k_2,l_2,s_2}^{\perp L\psi n} \cup \vec{B}_{N_2}^{L\psi e}.$$

Even through the relation (5.1) is established on the linearity, it is in fact truly for the linear and non-linear cases because the underlying graph of  $\vec{G}^{L\psi} [\vec{B}_v, \vec{D}_e]$ -flow can be decomposed into bouquets and dipoles, hold with conditions of Theorem 4.2. Thus, even if the dynamical equation of a particle  $P$  is non-linear, we can also adopt the presentation (5.1) to characterize the superposition and hold on the global behavior of  $P$ . Whence, it is a presentation on superposition of particles, both on linear and non-linear.

## §6. Further Discussions

Usually, a dynamic equation on a particle characterizes its behaviors. But *is its solution the same as the particle?* Certainly not! Classically, a dynamic equation is established on characters of particles, and different characters result in different equations. Thus the superposition of a particle should be characterized by at least 2 differential equations. However, for a particle  $P$ , all these equations are the same one by chance, i.e., one of the Schrödinger equation, Klein-Gordon equation or Dirac equation, which lead to the many world interpretation of H.Everett, i.e., put a same equation or Hilbert space on different place for different solutions in Fig.12. As it is shown in Theorems 4.1 – 4.4, we can interpret the solution of equation (1.1)-(1.3) to be a  $\vec{G}^{L\psi} [\vec{B}_v, \vec{D}_e]$ -flow, which properly characterizes the superposition behavior of particles by purely mathematics.

The  $\vec{G}$ -flow interpretation on differential equation opens a new way for understanding the behavior of nature, particularly on superposition of particles. In general, the dynamic equations on different characters maybe different, which would bring about contradicts equations, i.e., non-solvable equations. For example, we characterize the behavior of meson or baryon by Dirac equation (1.3). However, we never know the dynamic equation on quark. Although we can say it obeying the Dirac equation but it is not a complete picture on quark. If we find its

equation some day, they must be contradicts because it appear in different positions in space for a meson or a baryon at least. As a result, the  $\vec{G}$ -solutions on non-solvable differential equations discussed in [9]-[12] are valuable for understanding the reality of the nature with  $\vec{G}$ -flow solutions a special one on particles.

As it is well known for scientific community, any science possess the falsifiability but which depends on known scientific knowledge and technical means at that times. Accordingly, it is very difficult to claim a subject or topic with logical consistency is truth or false on the nature sometimes, for instance the multiverse or parallel universes because of the limitation of knowing things in the nature for human beings. In that case, a more appreciated approach is not denied or ignored but tolerant, extends classical sciences and developing those of well known technical means, and then get a better understanding on the nature because the pointless argument would not essentially promote the understanding of nature for human beings.

## References

- [1] R.Bousso and L.Susskind, Multiverse interpretation of quantum mechanics, *Physical Review*, D85(4), Doi:10.1103/PhysRevD.85.045007.
- [2] H.Everett, Relative state formulation of quantum mechanics, *Rev.Mod.Phys.*, 29(1957), 454-462.
- [3] E.George, Does the multiverse really exist?, *Scientific American*, 305(2011), 2011.
- [4] H.Kragh, Contemporary history of cosmology and controversy over the multiverse, *Annals of Science*, 66(4)(2009).
- [5] Tian Ma, *View Physics by Mathematics – Elementary Particles and Unified Field Theory*(in Chinese), Science Press, Beijing, 2014.
- [6] Linfan Mao, *Combinatorial Geometry with Applications to Field Theory*, The Education Publisher Inc., USA, 2011.
- [7] Linfan Mao, Combinatorial fields-an introduction, *International J. Math. Combin.*, Vol.1(2009), Vol.3, 1-22.
- [8] Linfan Mao, Relativity in combinatorial gravitational fields, *Progress in Physics*, Vol.3(2010), 39-50.
- [9] Linfan Mao, Global stability of non-solvable ordinary differential equations with applications, *International J.Math. Combin.*, Vol.1 (2013), 1-37.
- [10] Linfan Mao, Geometry on  $G^L$ -systems of homogenous polynomials, *International J.Contemp. Math. Sciences*, Vol.9 (2014), No.6, 287-308.
- [11] Linfan Mao, Non-solvable equation systems with graphs embedded in  $\mathbf{R}^n$ , *Proceedings of the First International Conference on Smarandache Multispace and Multistructure*, The Education Publisher Inc. July, 2013
- [12] Linfan Mao, Cauchy problem on non-solvable system of first order partial differential equations with applications, *Methods and Applications of Analysis* (Accepted and to appear).
- [13] Linfan Mao, Extended Banach  $\vec{G}$ -flow spaces on differential equations with applications, *Electronic J.Mathematical Analysis and Applications*, Vol.3, No.2 (2015), 59-91.
- [14] Y.Nambu, *Quarks: Frontiers in Elementary Particle Physics*, World Scientific Publishing

- Co.Pte.Ltd, 1985.
- [15] Peter Byrne, The many worlds of Hugh, *Scientific American*, December, 2007, 98-105.
  - [16] Quang Ho-Kim and Pham Xuan Yem, *Elementary Particles and Their Interactions*, Springer-Verlag Berlin Heidelberg, 1998.
  - [17] F.Smarandache, *Paradoxist Geometry*, State Archives from Valcea, Rm. Valcea, Romania, 1969, and in *Paradoxist Mathematics*, Collected Papers (Vol. II), Kishinev University Press, Kishinev, 5-28, 1997.
  - [18] F.Smarandache, Multi-space and multi-structure, in *Neutrosophy. Neutrosophic Logic, Set, Probability and Statistics*, American Research Press, 1998.
  - [19] P.Steinhardt, Theories of anything, <http://www.edge.org/response-detail/25405>.
  - [20] M.Tegmark, Parallel universes, in *Science and Ultimate Reality: From Quantum to Cosmos*, ed. by J.D.Barrow, P.C.W.Davies and C.L.Harper, Cambridge University Press, 2003.

## A Review on Natural Reality with Physical Equations

**Abstract:** A natural behavior is used to characterized by differential equation established on human observations, which is assumed to be on one particle or one field complied with reproducibility. However, the multilateral property of a particle  $P$  and the mathematical consistence determine that such a understanding is only local, not the whole reality on  $P$ , which leads to a central thesis for knowing the nature, i.e., *how to establish a physical equation with a proper interpretation on a thing*. As it is well-known, a thing consists of parts. Reviewing on observations, we classify them into two categories, i.e., *out-observation* and *in-observation* for discussion. The former is such an observation that the observer is out of the particle or the field  $P$ , which is in fact a macroscopic observation and its dynamic equation characterizes the coherent behavior of all parts in  $P$ , but the later is asked into the particle or the field by arranging observers simultaneously on different subparticles or subfields in  $P$  and respectively establishing physical equations, which are contradictory and given up in classical because there are not applicable conclusions on contradictory systems in mathematics. However, the existence naturally implies the necessity of the nature. Applying a combinatorial notion, i.e.,  $G^L$ -solutions on non-solvable equations, a new notion for holding on the reality of nature is suggested in this paper, which makes it clear that the knowing on the nature by solvable equations is macro, only holding on these coherent behaviors of particles, but the non-coherent naturally induces non-solvable equations, which implies that the knowing by  $G^L$ -solution of equations is the effective, includes the classical characterizing as a special case by solvable equations, i.e., mathematical combinatorics.

**Key Words:** Natural reality, out or in-observation, Smarandache multi-space, particle or field equation, interpretation, mathematical combinatorics.

**AMS(2010):** 51M15, 53B15, 53B40, 57N16, 81P05, 83C05, 83F05.

### §1. Introduction

An observation on a physical phenomenon, or characters of a thing in the nature is the received information via hearing, sight, smell, taste or touch, i.e., sensory organs of the observer himself, little by little for human beings fulfilled with the reproducibility. However, it is difficult to hold the true face of a thing for human beings because he is analogous to a blind man in “*the blind men with an elephant*”, a famous fable for knowing the nature. For example, let  $\mu_1, \mu_2, \dots, \mu_n$  be all observed and  $\nu_i, i \geq 1$  unobserved characters on a particle  $P$  at time  $t$ . Then,  $P$  should

---

<sup>1</sup> *Progress in Physics*, Vol.11, 3 (2015),276-282

be understood by

$$P = \left( \bigcup_{i=1}^n \{\mu_i\} \right) \cup \left( \bigcup_{k \geq 1} \{\nu_k\} \right) \quad (1.1)$$

in logic with an approximation  $P^\circ = \bigcup_{i=1}^n \{\mu_i\}$  for  $P$  at time  $t$ . All of them are nothing else but Smarandache multispaces ([17]). Thus,  $P \approx P^\circ$  is only an approximation for its true face of  $P$ , and it will never be ended in this way for knowing  $P$  as Lao Zi claimed “*Name named is not the eternal Name*” in the first chapter of his *TAO TEH KING* ([3]), a famous Chinese book.

A physical phenomenon of particle  $P$  is usually characterized by differential equation

$$\mathcal{F}(t, x_1, x_2, x_3, \psi_t, \psi_{x_1}, \psi_{x_2}, \dots, \psi_{x_1 x_2}, \dots) = 0 \quad (1.2)$$

in physics established on observed characters of  $\mu_1, \mu_2, \dots, \mu_n$  for its state function  $\psi(t, x)$  in  $\mathbb{R}^4$ . Usually, these physical phenomena of a thing is complex, and hybrid with other things. *Is the reality of particle  $P$  all solutions of that equation (1.2) in general?* Certainly not because the equation (1.2) only characterizes the behavior of  $P$  on some characters of  $\mu_1, \mu_2, \dots, \mu_n$  at time  $t$  abstractly, not the whole in philosophy. For example, the behavior of a particle is characterized by the Schrödinger equation

$$i\hbar \frac{\partial \psi}{\partial t} = -\frac{\hbar^2}{2m} \nabla^2 \psi + U\psi \quad (1.3)$$

in quantum mechanics but observation shows it in two or more possible states of being, i.e., superposition. We can not even say which solution of the Schrödinger equation (1.3) is the particle because each solution is only for one determined state. Even so, the understanding of all things is inexhaustible by (1.1).

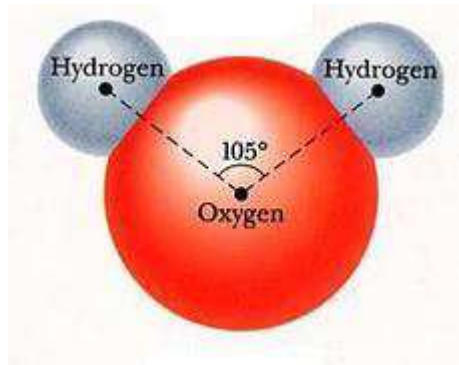

**Fig.1**

Furthermore, *can we conclude the equation (1.2) is absolutely right for a particle  $P$ ?* Certainly not also because the dynamic equation (1.2) is always established with an additional assumption, i.e., the geometry on a particle  $P$  is a point in classical mechanics or a field in quantum mechanics and dependent on the observer is out or in the particle. For example, a water molecule  $H_2O$  consists of 2 hydrogen atoms and 1 oxygen atom such as those shown in

Fig.1. If an observer receives information on the behaviors of hydrogen or oxygen atom but stands out of the water molecule  $H_2O$  by viewing it a geometrical point, then such an observation is an out-observation because it only receives such coherent information on atoms  $H$  and  $O$  with the water molecule  $H_2O$ .

If an observer is out the water molecule  $H_2O$ , his all observations on the hydrogen atom  $H$  and oxygen atom  $O$  are the same, but if he enters the interior of the molecule, he will view a different sceneries for atom  $H$  and atom  $O$ , which are respectively called *out-observation* and *in-observation*, and establishes 1 or 3 dynamic equations on the water molecule  $H_2O$ .

The main purpose of this paper is to clarify the natural reality of a particle with that of differential equations, and conclude that a solvable one characterizes only the reality of elementary particles but non-solvable system of differential equations essentially describe particles, such as those of baryons or mesons in the nature.

For terminologies and notations not mentioned here, we follow references [1] for mechanics, [5] for combinatorial geometry, [15] for elementary particles, and [17] for Smarandache systems and multispaces, and all phenomenons discussed in this paper are assumed to be true in the nature.

## §2. Out-Observations

An *out-observation* observes on the external, i.e., these macro but not the internal behaviors of a particle  $P$  by human senses or via instrumental, includes the size, magnitudes or eigenvalues of states,  $\dots$ , etc..

Certainly, the out-observation is the fundamental for quantitative research on matters of human beings. Usually, a dynamic equation (1.2) on a particle  $P$  is established by the principle of stationary action  $\delta S = 0$  with

$$S = \int_{t_1}^{t_2} dt L(q(t), \dot{q}(t)) \quad (2.1)$$

in classical mechanics, where  $q(t), \dot{q}(t)$  are respectively the generalized coordinates, the velocities and  $L(q(t), \dot{q}(t))$  the *Lagrange function* on the particle, and

$$S = \int_{\tau_2}^{\tau_1} d^4x \mathcal{L}(\phi, \partial_\mu \psi) \quad (2.2)$$

in field theory, where  $\psi$  is the state function and  $\mathcal{L}$  the *Lagrangian density* with  $\tau_1, \tau_2$  the limiting surfaces of integration by viewed  $P$  an independent system of dynamics or a field. The principle of stationary action  $\delta S = 0$  respectively induced the *Euler-Lagrange equations*

$$\frac{\partial L}{\partial q} - \frac{d}{dt} \frac{\partial L}{\partial \dot{q}} = 0 \quad \text{and} \quad \frac{\partial \mathcal{L}}{\partial \psi} - \partial_\mu \frac{\partial \mathcal{L}}{\partial (\partial_\mu \psi)} = 0 \quad (2.3)$$

in classical mechanics and field theory, which enables one to find the dynamic equations of



particles by properly choice of  $L$  or  $\mathcal{L}$ . For examples, let

$$\begin{aligned}\mathcal{L}_S &= \frac{i\hbar}{2} \left( \frac{\partial\psi}{\partial t} \bar{\psi} - \frac{\partial\bar{\psi}}{\partial t} \psi \right) - \frac{1}{2} \left( \frac{\hbar^2}{2m} |\nabla\psi|^2 + V|\psi|^2 \right), \\ \mathcal{L}_D &= \bar{\psi} \left( i\gamma^\mu \partial_\mu - \frac{mc}{\hbar} \right) \psi, \quad \mathcal{L}_{KG} = \frac{1}{2} \left( \partial_\mu \psi \partial^\mu \psi - \left( \frac{mc}{\hbar} \right)^2 \psi^2 \right).\end{aligned}$$

Then we respectively get the Schrödinger equation (1.3) or the Dirac equation

$$\left( i\gamma^\mu \partial_\mu - \frac{mc}{\hbar} \right) \psi(t, x) = 0 \quad (2.4)$$

for a free fermion  $\psi(t, x)$  and the Klein-Gordon equation

$$\left( \frac{1}{c^2} \frac{\partial^2}{\partial t^2} - \nabla^2 \right) \psi(x, t) + \left( \frac{mc}{\hbar} \right)^2 \psi(x, t) = 0 \quad (2.5)$$

for a free boson  $\psi(t, x)$  hold in relativistic forms by equation (2.3), where  $\hbar = 6.582 \times 10^{-22} MeVs$  is the Planck constant,  $c$  is the speed of light,

$$\begin{aligned}\nabla &= \left( \frac{\partial}{\partial x}, \frac{\partial}{\partial y}, \frac{\partial}{\partial z} \right), \quad \nabla^2 = \frac{\partial^2}{\partial x^2} + \frac{\partial^2}{\partial y^2} + \frac{\partial^2}{\partial z^2}, \\ \partial_\mu &= \left( \frac{1}{c} \frac{\partial}{\partial t}, \frac{\partial}{\partial x_1}, \frac{\partial}{\partial x_2}, \frac{\partial}{\partial x_3} \right), \quad \partial^\mu = \left( \frac{1}{c} \frac{\partial}{\partial t}, -\frac{\partial}{\partial x_1}, -\frac{\partial}{\partial x_2}, -\frac{\partial}{\partial x_3} \right)\end{aligned}$$

and  $\gamma^\mu = (\gamma^0, \gamma^1, \gamma^2, \gamma^3)$  with

$$\gamma^0 = \begin{pmatrix} I_{2 \times 2} & 0 \\ 0 & -I_{2 \times 2} \end{pmatrix}, \quad \gamma^i = \begin{pmatrix} 0 & \sigma_i \\ -\sigma_i & 0 \end{pmatrix}$$

with the usual Pauli matrices

$$\sigma_1 = \begin{pmatrix} 0 & 1 \\ 1 & 0 \end{pmatrix}, \quad \sigma_2 = \begin{pmatrix} 0 & -i \\ i & 0 \end{pmatrix}, \quad \sigma_3 = \begin{pmatrix} 1 & 0 \\ 0 & -1 \end{pmatrix}.$$

Furthermore, let  $\mathcal{L} = \sqrt{-g}R$ , where  $R = g^{\mu\nu} R_{\mu\nu}$ , the Ricci scalar curvature on the gravitational field. The equation (2.3) then induces the vacuum Einstein gravitational field equation

$$R_{\mu\nu} - \frac{1}{2} g_{\mu\nu} R = 0. \quad (2.6)$$

Usually, the equation established on the out-observations only characterizes those of coherent behaviors of all parts in a particle  $P$ . For example, a water molecule  $H_2O$  obeys the Schrödinger equation (1.3), we assume its hydrogen atom  $H$  and oxygen atom  $O$  also obey the Schrödinger equation (1.3) as a matter of course. However, the divisibility of matter initiates human beings to search elementary constituting cells of matter, i.e., elementary particles such as those of quarks, leptons with interaction quanta including photons and other particles of

mediated interactions, also with those of their antiparticles at present ([14]), and unmatters between a matter and its antimatter which is partially consisted of matter but others antimatter ([8-19]). For example, a baryon is predominantly formed from three quarks, and a meson is mainly composed of a quark and an antiquark in the models of Sakata, or Gell-Mann and Ne'eman on hadron and meson, such as those shown in Fig.2, where,  $q_i \in \{\mathbf{u}, \mathbf{d}, \mathbf{c}, \mathbf{s}, \mathbf{t}, \mathbf{b}\}$  denotes a quark for  $i = 1, 2, 3$  and  $\bar{q}_2 \in \{\bar{\mathbf{u}}, \bar{\mathbf{d}}, \bar{\mathbf{c}}, \bar{\mathbf{s}}, \bar{\mathbf{t}}, \bar{\mathbf{b}}\}$ , an antiquark. But a free quark was never found in experiments. We can not even conclude the Schrödinger equations (1.3) is the right equation (1.2) for quarks because it is established on an independent particle, can not be divided again in mathematics.

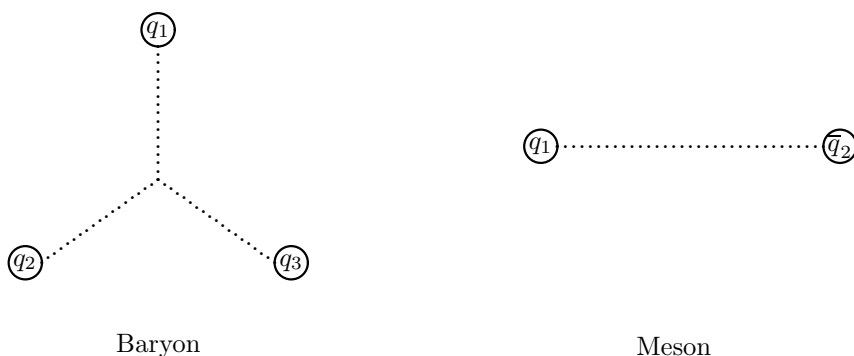

**Fig.2**

Then, *why is it believed without a shadow of doubt that the dynamical equations of elementary particles such as those of quarks, leptons with interaction quanta are (1.3) in physics?* It is because that all our observations come from a macro viewpoint, the human beings, not the particle itself, which rationally leads to H.Everett's multiverse interpretation on the superposition by letting parallel equations for the wave functions  $\psi(t, x)$  on positions of a particle in 1957 ([2]). We only hold coherent behaviors of elementary particles, such as those of quarks, leptons with interaction quanta and their antiparticles by equation (1.3), not the individual, and it is only an equation on those of particles viewed abstractly to be a geometrical point or an independent field from a macroscopic point, which leads physicists to assume the internal structures mechanically for hold the behaviors of particles such as those shown in Fig.2 on hadrons. However, such an assumption is a little ambiguous in logic, i.e., we can not even conclude which is the point or the independent field, the hadron or its subparticle, the quark.

In fact, a point is non-dividable in geometry. Even so, the assumption on the internal structure of particles by physicists was mathematically verified by extending Banach spaces to extended Banach spaces on topological graphs  $\vec{G}$  in [12]:

Let  $(\mathcal{V}; +, \cdot)$  be a Banach space over a field  $\mathcal{F}$  and  $\vec{G}$  a strong-connected topological graph with vertex set  $V$  and arc set  $X$ . A vector labeling  $\vec{G}^L$  on  $\vec{G}$  is a 1 - 1 mapping  $L: \vec{G} \rightarrow \mathcal{V}$

such that  $L : (u, v) \rightarrow L(u, v) \in \mathcal{V}$  for  $\forall (u, v) \in X(\vec{G})$  and it is a  $\vec{G}$ -flow if it holds with

$$L(u, v) = -L(v, u) \quad \text{and} \quad \sum_{u \in N_G(v)} L(v^u) = \mathbf{0}$$

for  $\forall (u, v) \in X(\vec{G})$ ,  $\forall v \in V(\vec{G})$ , where  $\mathbf{0}$  is the zero-vector in  $\mathcal{V}$ .

For  $\vec{G}$ -flows  $\vec{G}^L$ ,  $\vec{G}^{L_1}$ ,  $\vec{G}^{L_2}$  on a topological graph  $\vec{G}$  and  $\xi \in \mathcal{F}$  a scalar, it is clear that  $\vec{G}^{L_1} + \vec{G}^{L_2}$  and  $\xi \cdot \vec{G}^L$  are also  $\vec{G}$ -flows, which implies that all  $\vec{G}$ -flows on  $\vec{G}$  form a linear space over  $\mathcal{F}$  with unit  $\mathbf{0}$  under operations  $+$  and  $\cdot$ , denoted by  $\vec{G}^{\mathcal{V}}$ , where  $\mathbf{0}$  is such a  $\vec{G}$ -flow with vector  $\mathbf{0}$  on  $(u, v)$  for  $\forall (u, v) \in X(\vec{G})$ . Then, it was shown that  $\vec{G}^{\mathcal{V}}$  is a Banach space, and furthermore a Hilbert space if introduce

$$\begin{aligned} \|\vec{G}^L\| &= \sum_{(u,v) \in X(\vec{G})} \|L(u, v)\|, \\ \langle \vec{G}^{L_1}, \vec{G}^{L_2} \rangle &= \sum_{(u,v) \in X(\vec{G})} \langle L_1(u, v), L_2(u, v) \rangle \end{aligned}$$

for  $\forall \vec{G}^L, \vec{G}^{L_1}, \vec{G}^{L_2} \in \vec{G}^{\mathcal{V}}$ , where  $\|L(u, v)\|$  is the norm of  $L(u, v)$  and  $\langle \cdot, \cdot \rangle$  the inner product in  $\mathcal{V}$  if it is an inner space. The following result generalizes the representation theorem of Fréchet and Riesz on linear continuous functionals on  $\vec{G}$ -flow space  $\vec{G}^{\mathcal{V}}$ , which enables us to find  $\vec{G}$ -flow solutions on linear equations (1.2).

**Theorem 2.1**([12]) *Let  $\mathbf{T} : \vec{G}^{\mathcal{V}} \rightarrow \mathbb{C}$  be a linear continuous functional. Then there is a unique  $\vec{G}^{\hat{L}} \in \vec{G}^{\mathcal{V}}$  such that*

$$\mathbf{T}(\vec{G}^L) = \langle \vec{G}^L, \vec{G}^{\hat{L}} \rangle$$

for  $\forall \vec{G}^L \in \vec{G}^{\mathcal{V}}$ .

For non-linear equations (1.2), we can also get  $\vec{G}$ -flow solutions on them if  $\vec{G}$  can be decomposed into circuits.

**Theorem 2.2**([12]) *If the topological graph  $\vec{G}$  is strong-connected with circuit decomposition*

$$\vec{G} = \bigcup_{i=1}^l \vec{C}_i$$

such that  $L(u^v) = L_i(\mathbf{x})$  for  $\forall (u, v) \in X(\vec{C}_i)$ ,  $1 \leq i \leq l$  and the Cauchy problem

$$\begin{cases} \mathcal{F}_i(\mathbf{x}, u, u_{x_1}, \dots, u_{x_n}, u_{x_1 x_2}, \dots) = 0 \\ u|_{\mathbf{x}_0} = L_i(\mathbf{x}) \end{cases}$$

is solvable in a Hilbert space  $\mathcal{V}$  on domain  $\Delta \subset \mathbb{R}^n$  for integers  $1 \leq i \leq l$ , then the Cauchy

problem

$$\begin{cases} \mathcal{F}_i(\mathbf{x}, X, X_{x_1}, \dots, X_{x_n}, X_{x_1x_2}, \dots) = 0 \\ X|_{\mathbf{x}_0} = \vec{G}^L \end{cases}$$

such that  $L(u^v) = L_i(\mathbf{x})$  for  $\forall(u, v) \in X(\vec{C}_i)$  is solvable for  $X \in \vec{G}^\mathcal{V}$ .

Theorems 2.1 – 2.2 conclude the existence of  $\vec{G}$ -flow solution on linear or non-linear differential equations for a topological graph  $\vec{G}$ , such as those of the Schrödinger equation (1.3), Dirac equation (2.4) and the Klein-Gordon equation (2.5), which all implies the rightness of physicists assuming the internal structures for hold the behaviors of particles because there are infinite many such graphs  $\vec{G}$  satisfying conditions of Theorem 2.1 – 2.2, particularly, the bouquet  $\vec{B}_N^{L_\psi}$ , the dipoles  $\vec{D}_{0,2N,0}^{L_\psi}$  for elementary particles in [13].

### §3. In-Observations

An *in-observation* observes on the internal behaviors of a particle, particularly, a composed particle  $P$ . Let  $P$  be composed by particles  $P_1, P_2, \dots, P_m$ . Different from out-observation from a macro viewing, an in-observation requires the observer holding the respective behaviors of particles  $P_1, P_2, \dots, P_m$  in  $P$ , for instance an observer enters a water molecule  $H_2O$  receiving information on the hydrogen or oxygen atoms  $H, O$ .

For such an observation, there are 2 observing ways:

(1) there is an apparatus such that an observer can simultaneously observes behaviors of particles  $P_1, P_2, \dots, P_m$ , i.e.,  $P_1, P_2, \dots, P_m$  can be observed independently as particles at the same time for the observer;

(2) there are  $m$  observers  $O_1, O_2, \dots, O_m$  simultaneously observe particles  $P_1, P_2, \dots, P_m$ , i.e., the observer  $O_i$  only observes the behavior of particle  $P_i$  for  $1 \leq i \leq m$ , called *parallel observing*, such as those shown in Fig.3 for the water molecule  $H_2O$  with  $m = 3$ .

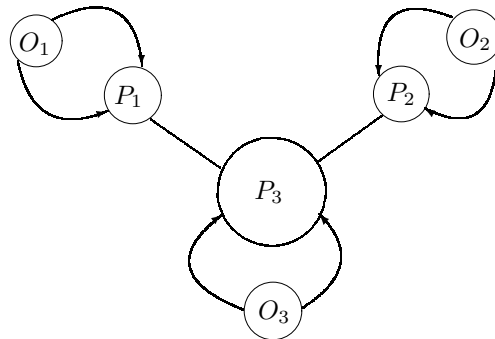

Fig.3

Certainly, each of these observing views a particle in  $P$  to be an independent particle, which enables us to establish the dynamic equation (1.2) by Euler-Lagrange equation (2.3) for

$P_i, 1 \leq i \leq m$ , respectively, and then we can apply the system of differential equations

$$\left\{ \begin{array}{l} \frac{\partial L_1}{\partial \mathbf{q}} - \frac{d}{dt} \frac{\partial L_1}{\partial \dot{\mathbf{q}}} = 0 \\ \frac{\partial L_2}{\partial \mathbf{q}} - \frac{d}{dt} \frac{\partial L_2}{\partial \dot{\mathbf{q}}} = 0 \\ \dots\dots\dots \\ \frac{\partial L_m}{\partial \mathbf{q}} - \frac{d}{dt} \frac{\partial L_m}{\partial \dot{\mathbf{q}}} = 0 \\ \mathbf{q}(t_0) = \mathbf{q}_0, \dot{\mathbf{q}}(t_0) = \dot{\mathbf{q}}_0 \end{array} \right. \quad (3.1)$$

for characterizing particle  $P$  in classical mechanics, or

$$\left\{ \begin{array}{l} \frac{\partial \mathcal{L}_1}{\partial \psi} - \partial_\mu \frac{\partial \mathcal{L}_1}{\partial (\partial_\mu \psi)} = 0 \\ \frac{\partial \mathcal{L}_2}{\partial \psi} - \partial_\mu \frac{\partial \mathcal{L}_2}{\partial (\partial_\mu \psi)} = 0 \\ \dots\dots\dots \\ \frac{\partial \mathcal{L}_m}{\partial \psi} - \partial_\mu \frac{\partial \mathcal{L}_m}{\partial (\partial_\mu \psi)} = 0 \\ \psi(t_0) = \psi_0 \end{array} \right. \quad (3.2)$$

for characterizing particle  $P$  in field theory, where the  $i$ th equation is the dynamic equation of particle  $P_i$  with initial data  $\mathbf{q}_0, \dot{\mathbf{q}}_0$  or  $\psi_0$ .

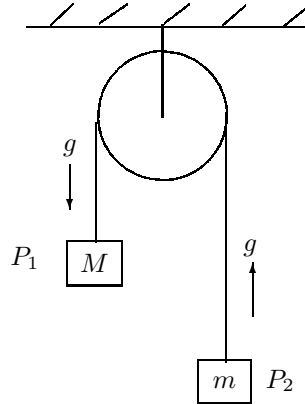

**Fig.4**

We discuss the solvability of systems (3.1) and (3.2). Let

$$S_{\mathbf{q}_i} = \left\{ (x_i, y_i, z_i)(\mathbf{q}_i, t) \in \mathbb{R}^3 \left| \frac{\partial L_i}{\partial \mathbf{q}_i} - \frac{d}{dt} \frac{\partial L_i}{\partial \dot{\mathbf{q}}_i} = 0, \mathbf{q}_i(t_0) = \mathbf{q}_0, \dot{\mathbf{q}}_i(t_0) = \dot{\mathbf{q}}_0 \right. \right\}$$

for integers  $1 \leq i \leq m$ . Then, the system (3.1) of equations is solvable if and only if

$$\mathcal{D}(\mathbf{q}) = \bigcap_{i=1}^m S_{\mathbf{q}_i} \neq \emptyset. \quad (3.3)$$

Otherwise, the system (3.1) is non-solvable. For example, let particles  $P_1, P_2$  of masses  $M, m$  be hanged on a fixed pulley, such as those shown in Fig.4. Then, the dynamic equations on  $P_1$  and  $P_2$  are respectively

$$P_1 : \quad \ddot{x} = g, \quad x(t_0) = x_0 \quad \text{and} \quad P_2 : \quad \ddot{x} = -g, \quad x(t_0) = x_0$$

but the system

$$\begin{cases} \ddot{x} = g \\ \ddot{x} = -g, \quad x(t_0) = x_0 \end{cases}$$

is contradictory, i.e., non-solvable.

Similarly, let  $\psi_i(x, t)$  be the state function of particle  $P_i$ , i.e., the solution of

$$\begin{cases} \frac{\partial \mathcal{L}_1}{\partial \psi_i} - \partial_\mu \frac{\partial \mathcal{L}_1}{\partial (\partial_\mu \psi_i)} = 0 \\ \psi(t_0) = \psi_0 \end{cases}$$

Then, the system (3.2) is solvable if and only if there is a state function  $\psi(x, t)$  on  $P$  hold with each equation of system (3.2), i.e.,

$$\psi(x, t) = \psi_1(x, t) = \cdots = \psi_m(x, t), \quad x \in \mathbb{R}^3,$$

which is impossible because if all state functions  $\psi_i(x, t)$ ,  $1 \leq i \leq m$  are the same, the particles  $P_1, P_2, \dots, P_m$  are nothing else but just one particle. Whence, the system (3.2) is non-solvable if  $m \geq 2$ , which implies we can not characterize the behavior of particle  $P$  by classical solutions of differential equations.

For example, if the state function  $\psi_O(x, t) = \psi_{H_1}(x, t) = \psi_{H_2}(x, t)$  in the water molecule  $H_2O$  for  $x \in \mathbb{R}^3$  hold with

$$\begin{cases} -i\hbar \frac{\partial \psi_O}{\partial t} = \frac{\hbar^2}{2m_O} \nabla^2 \psi_O - V(x) \psi_O \\ -i\hbar \frac{\partial \psi_{H_1}}{\partial t} = \frac{\hbar^2}{2m_{H_1}} \nabla^2 \psi_{H_1} - V(x) \psi_{H_1} \\ -i\hbar \frac{\partial \psi_{H_2}}{\partial t} = \frac{\hbar^2}{2m_{H_2}} \nabla^2 \psi_{H_2} - V(x) \psi_{H_2} \end{cases}$$

Then  $\psi_O(x, t) = \psi_{H_1}(x, t) = \psi_{H_2}(x, t)$  concludes that

$$A_O e^{-\frac{i}{\hbar}(E_O t - \mathbf{p}_O x)} = A_{H_1} e^{-\frac{i}{\hbar}(E_{H_1} t - \mathbf{p}_{H_1} x)} = A_{H_2} e^{-\frac{i}{\hbar}(E_{H_2} t - \mathbf{p}_{H_2} x)}$$

for  $\forall x \in \mathbb{R}^3$  and  $t \in \mathbb{R}$ , which implies that

$$A_O = A_{H_1} = A_{H_2}, \quad E_O = E_{H_1} = E_{H_2} \quad \text{and} \quad \mathbf{p}_O = \mathbf{p}_{H_1} = \mathbf{p}_{H_2},$$

a contradiction.

Notice that each equation in systems (3.1) and (3.2) is solvable but the system itself is

non-solvable in general, and they are real in the nature. Even if the system (3.1) holds with condition (3.3), i.e., it is solvable, we can not apply the solution of (3.1) to characterize the behavior of particle  $P$  because such a solution only describes the coherent behavior of particles  $P_1, P_2, \dots, P_m$ . Thus, we can not characterize the behavior of particle  $P$  by the solvability of systems (3.1) or (3.2). We should search new method to characterize systems (3.1) or (3.2).

Philosophically, the formula (1.1) is the understanding of particle  $P$  and all of these particles  $P_1, P_2, \dots, P_m$  are inherently related, not isolated, which implies that  $P$  naturally inherits a topological structure  $G^L[P]$  in space of the nature, which is a vertex-edge labeled topological graph determined by:

$$V(G^L[P]) = \{P_1, P_2, \dots, P_m\},$$

$$E(G^L[P]) = \{(P_i, P_j) | P_i \cap P_j \neq \emptyset, 1 \leq i \neq j \leq m\}$$

with labeling

$$L : P_i \rightarrow L(P_i) = P_i \quad \text{and} \quad L : (P_i, P_j) \rightarrow L(P_i, P_j) = P_i \cap P_j$$

for integers  $1 \leq i \neq j \leq m$ . For example, the topological graphs  $G^L[P]$  of water molecule  $H_2O$ , meson and baryon in the quark model of Gell-Mann and Ne'eman are respectively shown in Fig.5,

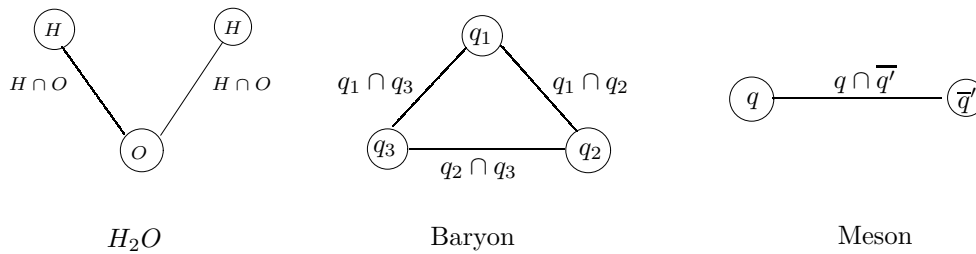

Fig.5

where  $O, H, q, \bar{q}$  and  $q_i, 1 \leq i \leq 3$  obey the Dirac equation but  $O \cap H, q \cap \bar{q}, q_k \cap q_l, 1 \leq k, l \leq 3$  comply with the Klein-Gordon equation.

Such a vertex-edge labeled topological graph  $G^L[P]$  is called  $G^L$ -solution of systems (3.1) or (3.2). Clearly, the global behaviors of particle  $P$  are determined by particles  $P_1, P_2, \dots, P_m$ . We can hold them on  $G^L$ -solution of systems (3.1) or (3.2). For example, let  $u^{[v]}$  be the solution of equation at vertex  $v \in V(G^L[P])$  with initial value  $u_0^{[v]}$  and  $G^{L_0}[P]$  the initial  $G^L$ -solution, i.e., labeled with  $u_0^{[v]}$  at vertex  $v$ . Then, a  $G^L$ -solution of systems (3.1) or (3.2) is *sum-stable* if for any number  $\varepsilon > 0$  there exists  $\delta_v > 0, v \in V(G^{L_0}[P])$  such that each  $G^{L'}$ -solution with

$$|u_0'^{[v]} - u_0^{[v]}| < \delta_v, \quad \forall v \in V(G^{L_0}[P])$$

exists for all  $t \geq 0$  and with the inequality

$$\left| \sum_{v \in V(G^{L'}[P])} u'^{[v]} - \sum_{v \in V(G^L[P])} u^{[v]} \right| < \varepsilon$$

holds, denoted by  $G^L[P] \overset{\Sigma}{\approx} G^{L_0}[P]$ . Furthermore, if there exists a number  $\beta_v > 0$  for  $\forall v \in V(G^{L_0}[P])$  such that every  $G^{L'}[P]$ -solution with

$$\left| u_0'^{[v]} - u_0^{[v]} \right| < \beta_v, \quad \forall v \in V(G^{L_0}[P])$$

satisfies

$$\lim_{t \rightarrow \infty} \left| \sum_{v \in V(G^{L'}[P])} u'^{[v]} - \sum_{v \in V(G^L[P])} u^{[v]} \right| = 0,$$

then the  $G^L[P]$ -solution is called asymptotically stable, denoted by  $G^L[P] \overset{\Sigma}{\rightarrow} G^{L_0}[P]$ .

Similarly, the energy integral of  $G^L$ -solution is determined by

$$E(G^L[P]) = \sum_{G \leq G^{L_0}[P]} (-1)^{|G|+1} \int_{\mathcal{O}_G} \left( \frac{\partial u^G}{\partial t} \right)^2 dx_1 dx_2 \cdots dx_{n-1},$$

where  $u^G$  is the  $\mathbb{C}^2$  solution of system

$$\left. \begin{array}{l} \frac{\partial u}{\partial t} = H_v(t, x_1, \cdots, x_{n-1}, p_1, \cdots, p_{n-1}) \\ u|_{t=t_0} = u_0^{[v]}(x_1, x_2, \cdots, x_{n-1}) \end{array} \right\} v \in V(G)$$

and  $\mathcal{O}_G = \bigcap_{v \in V(G)} \mathcal{O}_v$  with  $\mathcal{O}_v \subset \mathbb{R}^n$  determined by the  $v$ th equation

$$\left\{ \begin{array}{l} \frac{\partial u}{\partial t} = H_v(t, x_1, \cdots, x_{n-1}, p_1, \cdots, p_{n-1}) \\ u|_{t=t_0} = u_0^{[v]}(x_1, x_2, \cdots, x_{n-1}) \end{array} \right.$$

All of these global properties were extensively discussed in [7-11], which provides us to hold behaviors of a composed particle  $P$  by its constitutions  $P_1, P_2, \cdots, P_m$ .

#### §4. Reality

Generally, the reality is the state characters (1.1) of existed, existing or will existing things whether or not they are observable or comprehensible by human beings, and the observing objective is on the state of particles, which then enables us to find the reality of a particle. However, an observation is dependent on the perception of the observer by his organs or through by instruments at the observing time, which concludes that to hold the reality of a particle  $P$  can be only little by little, and determines local reality of  $P$  from a macro observation at a



time  $t$ , no matter what  $P$  is, a macro or micro thing. Why is this happening because we always observe by one observer on one particle assumed to be a point in space, and then establish a solvable equation (1.2) on coherent, not individual behaviors of  $P$ . Otherwise, we get non-solvable equations on  $P$  contradicts to the law of contradiction, the foundation of classical mathematics which results in discussions following:

**4.1 States of Particles are Multiverse.** A particle  $P$  understood by formula (1.1) is in fact a multiverse consisting of known characters  $\mu_1, \mu_2, \dots, \mu_n$  and unknown characters  $\nu_k, k \geq 1$ , i.e., different characters characterize different states of particle  $P$ . This fact also implies that the multiverse exist everywhere if we understand a particle  $P$  with in-observation, not only those levels of  $I - IV$  of Max Tegmark in [24]. In fact, the infinite divisibility of a matter  $M$  in philosophy alludes nothing else but a multiverse observed on  $M$  by its individual submatters. Thus, the nature of a particle  $P$  is multiple in front of human beings, with unity character appeared only in specified situations.

**4.2 Reality Only Characterized by Non-Compatible System.** Although the dynamical equations (1.2) established on unilateral characters are individually compatible but they must be globally contradictory with these individual features unless all characters are the same one. It can not be avoided by the nature of a particle  $P$ . Whence, the non-compatible system, particularly, non-solvable systems consisting of solvable differential equations are suitable tools for holding the reality of particles  $P$  in the world, which also partially explains a complaint of Einstein on mathematics, i.e., *as far as the laws of mathematics refer to reality, they are not certain; and as far as they are certain, they do not refer to reality* because the multiple nature of all things.

**4.3 Reality Really Needs Mathematics on Graph.** As we known, there always exist a universal connection between things in a family in philosophy. Thus, a family  $\mathcal{F}$  of things naturally inherits a topological graph  $G^L[\mathcal{F}]$  in space and we therefore conclude that

$$\mathcal{F} = G^L[\mathcal{F}] \quad (4.1)$$

in that space. Particularly, if all things in  $\mathcal{F}$  are nothing else but manifolds  $M_T(x_1, x_2, x_3; t)$  of particles  $P$  determined by equation

$$f_T(x_1, x_2, x_3; t) = 0, \quad T \in \mathcal{F} \quad (4.2)$$

in  $\mathbb{R}^3 \times \mathbb{R}$ , we get a geometrical figure  $\bigcup_{T \in \mathcal{F}} M_T(x_1, x_2, x_3; t)$ , a combinatorial filed ([6]) for  $\mathcal{F}$ .

Clearly, the graph  $G^L[\mathcal{F}]$  characterizes the behavior of  $\mathcal{F}$  no matter what the system (4.2) is solvable or not. Calculation shows that the system (4.2) of equations is non-solvable or not dependent on

$$\bigcap_{T \in \mathcal{F}} M_T(x_1, x_2, x_3; t) = \emptyset \quad \text{or not.}$$

Particularly, if  $\bigcap_{T \in \mathcal{F}} M_T(x_1, x_2, x_3; t) = \emptyset$ , the system (4.2) is non-solvable and we can not just characterize the behavior of  $\mathcal{F}$  by the solvability of system (4.2). We must turn the

contradictory system (4.2) to a compatible one, such as those shown in [10] and have to extend mathematical systems on graph  $G^L[\mathcal{F}]$  ([12]) for holding the reality of  $\mathcal{F}$ .

Notice that there is a conjectured for developing mathematics in [4] called *CC conjecture* which claims that *any mathematical science can be reconstructed from or turned into combinatorization*. Such a conjecture is in fact a combinatorial notion for developing mathematics on topological graphs, i.e., finds the combinatorial structure to reconstruct or generalize classical mathematics, or combines different mathematical sciences and establishes a new enveloping theory on topological graphs for hold the reality of things  $\mathcal{F}$ .

## §5. Conclusion

Reality of a thing is hold on observation with level dependent on the observer standing out or in that thing, particularly, a particle classified to out or in-observation, or parallel observing from a macro or micro view and characterized by solvable or non-solvable differential equations, consistent with the universality principle of contradiction in philosophy. For holding on the reality of things, the out-observation is basic but the in-observation is cardinal. Correspondingly, the solvable equation is individual but the non-solvable equations are universal. Accompanying with the establishment of compatible systems, we are also needed to characterize those of contradictory systems, particularly, non-solvable differential equations on particles and establish mathematics on topological graphs, i.e., *mathematical combinatorics*, and only which is the appropriated way for understanding the nature because all things are in contradiction.

## References

- [1] R.Abraham and J.E.Marsden, *Foundation of Mechanics* (2nd edition), Addison-Wesley, Reading, Mass, 1978.
- [2] H.Everett, Relative state formulation of quantum mechanics, *Rev.Mod.Phys.*, 29(1957), 454-462.
- [3] J.C.Lu, *Fangfo Analyzing LAO ZHI - Explaining TAO TEH KING by TAI JI* (in Chinese), Tuan Jie Publisher, Beijing, 2004.
- [4] Linfan Mao, Combinatorial speculation and combinatorial conjecture for mathematics, *International J.Math. Combin.* Vol.1(2007), No.1, 1-19.
- [5] Linfan Mao, *Combinatorial Geometry with Applications to Field Theory*, The Education Publisher Inc., USA, 2011.
- [6] Linfan Mao, Combinatorial fields-an introduction, *International J. Math. Combin.*, Vol.1(2009), Vol.3, 1-22.
- [7] Linfan Mao, Global stability of non-solvable ordinary differential equations with applications, *International J.Math. Combin.*, Vol.1 (2013), 1-37.
- [8] Linfan Mao, Non-solvable equation systems with graphs embedded in  $\mathbf{R}^n$ , *Proceedings of the First International Conference on Smarandache Multispace and Multistructure*, The Education Publisher Inc. July, 2013

- [9] Linfan Mao, Geometry on  $G^L$ -systems of homogenous polynomials, *International J. Contemp. Math. Sciences*, Vol.9 (2014), No.6, 287-308.
- [10] Linfan Mao, Mathematics on non-mathematics - A combinatorial contribution, *International J.Math. Combin.*, Vol.3(2014), 1-34.
- [11] Linfan Mao, Cauchy problem on non-solvable system of first order partial differential equations with applications, *Methods and Applications of Analysis*, Vol.22, 2(2015), 171-200.
- [12] Linfan Mao, Extended Banach  $\vec{G}$ -flow spaces on differential equations with applications, *Electronic J.Mathematical Analysis and Applications*, Vol.3, No.2 (2015), 59-91.
- [13] Linfan Mao, A new understanding of particles by  $\vec{G}$ -flow interpretation of differential equation, *Progress in Physics*, Vol.11(2015), 39-50.
- [14] Y.Nambu, *Quarks: Frontiers in Elementary Particle Physics*, World Scientific Publishing Co.Pte.Ltd, 1985.
- [15] Quang Ho-Kim and Pham Xuan Yem, *Elementary Particles and Their Interactions*, Springer-Verlag Berlin Heidelberg, 1998.
- [16] T.Reid, An inquiry into the human mind on the principles of common sense, in D.Brookes ed., Edinburgh University Press, 1997.
- [17] F.Smarandache, *Paradoxist Geometry*, State Archives from Valcea, Rm. Valcea, Romania, 1969, and in *Paradoxist Mathematics*, Collected Papers (Vol. II), Kishinev University Press, Kishinev, 5-28, 1997.
- [18] F.Smarandache, A new form of matter – unmatter, composed of particles and anti-particles, *Progress in Physics*, Vol.1(2005), 9-11.
- [20] F.Smarandache and D.Rabounski, Unmatter entities inside nuclei, predicted by the Brightsen nucleon cluster model, *Progress in Physics*, Vol.1(2006), 14-18.
- [20] M.Tegmark, Parallel universes, in *Science and Ultimate Reality: From Quantum to Cosmos*, ed. by J.D.Barrow, P.C.W.Davies and C.L.Harper, Cambridge University Press, 2003.

## Chapter 2 Contradiction with Reality

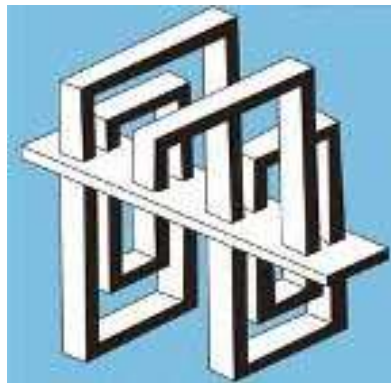

*Contradictions are the resource, and the motive force of human beings for creation.*

By Karl Heinrich Marx, a Prussian philosopher and political economist.

## Mathematics on Non-Mathematics

– *A Combinatorial Contribution*

**Abstract:** A classical system of mathematics is homogenous without contradictions. But it is a little ambiguous for modern mathematics, for instance, the Smarandache geometry. Let  $\mathcal{F}$  be a family of things such as those of particles or organizations. Then, *how to hold its global behaviors or true face?* Generally,  $\mathcal{F}$  is not a mathematical system in usual unless a set, i.e., a system with contradictions. There are no mathematical subfields applicable. Indeed, the trend of mathematical developing in 20th century shows that a mathematical system is more concise, its conclusion is more extended, but farther to the true face for its abandoned more characters of things. This effect implies an important step should be taken for mathematical development, i.e., turn the way to extending non-mathematics in classical to mathematics, which also be provided with the philosophy. All of us know *there always exists a universal connection between things in  $\mathcal{F}$* . Thus there is an underlying structure, i.e., a vertex-edge labeled graph  $G$  for things in  $\mathcal{F}$ . Such a labeled graph  $G$  is invariant accompanied with  $\mathcal{F}$ . The main purpose of this paper is to survey how to extend classical mathematical non-systems, such as those of algebraic systems with contradictions, algebraic or differential equations with contradictions, geometries with contradictions, and generally, classical mathematics systems with contradictions to mathematics by the underlying structure  $G$ . All of these discussions show that a non-mathematics in classical is in fact a mathematics underlying a topological structure  $G$ , i.e., mathematical combinatorics, and contribute more to physics and other sciences.

**Key Words:** Non-mathematics, topological graph, Smarandache system, non-solvable equation, CC conjecture, mathematical combinatorics.

**AMS(2010):** 03A10,05C15,20A05, 34A26,35A01,51A05,51D20,53A35

### §1. Introduction

A thing is complex, and hybrid with other things sometimes. That is why it is difficult to know the true face of all things, included in “Name named is not the eternal Name; the unnamable is the eternally real and naming the origin of all things”, the first chapter of *TAO TEH KING* [9], a well-known Chinese book written by an ideologist, *Lao Zi* of China. In fact, all of things with universal laws acknowledged come from the six organs of mankind. Thus, the words “*existence*” and “*non-existence*” are knowledged by human, which maybe not implies the true existence or not in the universe. Thus the existence or not for a thing is *invariant*, independent on human knowledge.

---

<sup>1</sup>*International J.Math.Combin*, Vol.3 (2014), 1-34.

The boundedness of human beings brings about a unilateral knowledge for things in the world. Such as those shown in a famous proverb “the blind men with an elephant”. In this proverb, there are six blind men were asked to determine what an elephant looked like by feeling different parts of the elephant’s body. The man touched the elephant’s leg, tail, trunk, ear, belly or tusk respectively claims it’s like a pillar, a rope, a tree branch, a hand fan, a wall or a solid pipe, such as those shown in Fig.1 following. Each of them insisted on his own and not accepted others. They then entered into an endless argument.

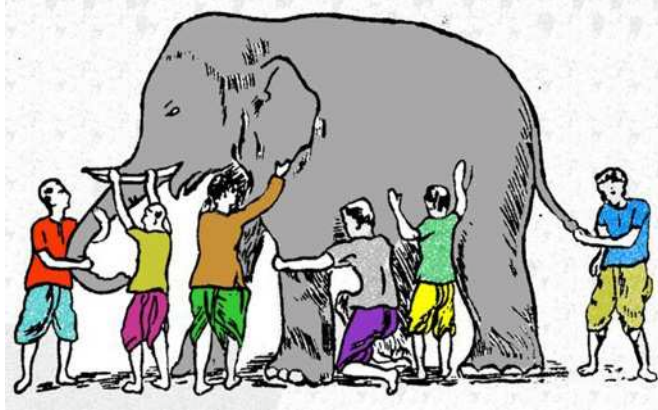

Fig.1

*All of you are right!* A wise man explains to them: *why are you telling it differently is because each one of you touched the different part of the elephant. So, actually the elephant has all those features what you all said.* Thus, the best result on an elephant for these blind men is

$$\begin{aligned} \text{An elephant} &= \{4 \text{ pillars}\} \cup \{1 \text{ rope}\} \cup \{1 \text{ tree branch}\} \\ &\cup \{2 \text{ hand fans}\} \cup \{1 \text{ wall}\} \cup \{1 \text{ solid pipe}\} \end{aligned}$$

*What is the meaning of this proverb for understanding things in the world?* It lies in that the situation of human beings knowing things in the world is analogous to these blind men. Usually, a thing  $T$  is identified with its known characters ( or name ) at one time, and this process is advanced gradually by ours. For example, let  $\mu_1, \mu_2, \dots, \mu_n$  be its known and  $\nu_i, i \geq 1$  unknown characters at time  $t$ . Then, the thing  $T$  is understood by

$$T = \left( \bigcup_{i=1}^n \{\mu_i\} \right) \cup \left( \bigcup_{k \geq 1} \{\nu_k\} \right) \quad (1.1)$$

in logic and with an approximation  $T^\circ = \bigcup_{i=1}^n \{\mu_i\}$  for  $T$  at time  $t$ . This also answered why difficult for human beings knowing a thing really.

Generally, let  $\Sigma$  be a finite or infinite set. A *rule* or a *law* on a set  $\Sigma$  is a mapping  $\underbrace{\Sigma \times \Sigma \cdots \times \Sigma}_n \rightarrow \Sigma$  for some integers  $n$ . Then, a *mathematical system* is a pair  $(\Sigma; \mathcal{R})$ , where

$\mathcal{R}$  consists those of rules on  $\Sigma$  by logic providing all these resultants are still in  $\Sigma$ .

**Definition 1.1**([28]-[30]) *Let  $(\Sigma_1; \mathcal{R}_1), (\Sigma_2; \mathcal{R}_2), \dots, (\Sigma_m; \mathcal{R}_m)$  be  $m$  mathematical system, different two by two. A Smarandache multisystem  $\tilde{\Sigma}$  is a union  $\bigcup_{i=1}^m \Sigma_i$  with rules  $\tilde{\mathcal{R}} = \bigcup_{i=1}^m \mathcal{R}_i$  on  $\tilde{\Sigma}$ , denoted by  $(\tilde{\Sigma}; \tilde{\mathcal{R}})$ .*

Consequently, the thing  $T$  is nothing else but a Smarandache multisystem (1.1). However, these characters  $\nu_k, k \geq 1$  are unknown for one at time  $t$ . Thus,  $T \approx T^\circ$  is only an approximation for its true face and it will never be ended in this way for knowing  $T$ , i.e., “Name named is not the eternal Name”, as Lao Zi said.

But one’s life is limited by its nature. It is nearly impossible to find all characters  $\nu_k, k \geq 1$  identifying with thing  $T$ . Thus one can only understands a thing  $T$  relatively, namely find invariant characters  $\mathcal{I}$  on  $\nu_k, k \geq 1$  independent on artificial frame of references. In fact, this notion is consistent with *Erlangen Programme* on developing geometry by Klein [10]: *given a manifold and a group of transformations of the same, to investigate the configurations belonging to the manifold with regard to such properties as are not altered by the transformations of the group*, also the fountainhead of *General Relativity* of Einstein [2]: *any equation describing the law of physics should have the same form in all reference frame*, which means that a universal law does not moves with the volition of human beings. Thus, an applicable mathematical theory for a thing  $T$  should be an *invariant theory* acting on by all automorphisms of the artificial frame of reference for thing  $T$ .

All of us have known that things are inherently related, not isolated in philosophy, which implies that these is an underlying structure in characters  $\mu_i, 1 \leq i \leq n$  for a thing  $T$ , namely, an inherited topological graph  $G$ . Such a graph  $G$  should be independent on the volition of human beings. Generally, a labeled graph  $G$  for a Smarandache multi-space is introduced following.

**Definition 1.2**([21]) *For any integer  $m \geq 1$ , let  $(\tilde{\Sigma}; \tilde{\mathcal{R}})$  be a Smarandache multisystem consisting of  $m$  mathematical systems  $(\Sigma_1; \mathcal{R}_1), (\Sigma_2; \mathcal{R}_2), \dots, (\Sigma_m; \mathcal{R}_m)$ . An inherited topological structure  $G[\tilde{\mathcal{S}}]$  of  $(\tilde{\Sigma}; \tilde{\mathcal{R}})$  is a topological vertex-edge labeled graph defined following:*

$$V(G[\tilde{\mathcal{S}}]) = \{\Sigma_1, \Sigma_2, \dots, \Sigma_m\},$$

$$E(G[\tilde{\mathcal{S}}]) = \{(\Sigma_i, \Sigma_j) | \Sigma_i \cap \Sigma_j \neq \emptyset, 1 \leq i \neq j \leq m\} \text{ with labeling}$$

$$L : \Sigma_i \rightarrow L(\Sigma_i) = \Sigma_i \quad \text{and} \quad L : (\Sigma_i, \Sigma_j) \rightarrow L(\Sigma_i, \Sigma_j) = \Sigma_i \cap \Sigma_j$$

for integers  $1 \leq i \neq j \leq m$ .

However, classical combinatorics paid attentions mainly on techniques for catering the need of other sciences, particularly, the computer science and children games by artificially giving up individual characters on each system  $(\Sigma, \mathcal{R})$ . For applying more it to other branch sciences initiatively, a good idea is pullback these individual characters on combinatorial objects again, ignored by the classical combinatorics, and back to the true face of things, i.e., an interesting conjecture on mathematics following:

**Conjecture 1.3**(CC Conjecture, [15],[19]) *A mathematics can be reconstructed from or turned into combinatorization.*

Certainly, this conjecture is true in philosophy. So it is in fact a combinatorial notion on developing mathematical sciences. Thus:

(1) *One can combine different branches into a new theory and this process ended until it has been done for all mathematical sciences, for instance, topological groups and Lie groups.*

(2) *One can select finite combinatorial rulers and axioms to reconstruct or make generalizations for classical mathematics, for instance, complexes and surfaces.*

From its formulated, the CC conjecture brings about a new way for developing mathematics, and it has affected on mathematics more and more. For example, it contributed to groups, rings and modules ([11]-[14]), topology ([23]-[24]), geometry ([16]) and theoretical physics ([17]-[18]), particularly, these 3 monographs [19]-[21] motivated by this notion.

A *mathematical non-system* is such a system with contradictions. Formally, let  $\mathcal{R}$  be mathematical rules on a set  $\Sigma$ . A pair  $(\Sigma; \mathcal{R})$  is non-mathematics if there is at least one ruler  $R \in \mathcal{R}$  validated and invalidated on  $\Sigma$  simultaneously. Notice that a multi-system defined in Definition 1.1 is in fact a system with contradictions in the classical view, but it is cooperated with logic by Definition 1.2. Thus, it lights up the hope of transferring a system with contradictions to mathematics, consistent with logic by combinatorial notion.

The main purpose of this paper is to show how to transfer a mathematical non-system, such as those of non-algebra, non-group, non-ring, non-solvable algebraic equations, non-solvable ordinary differential equations, non-solvable partial differential equations and non-Euclidean geometry, mixed geometry, differential non-Euclidean geometry,  $\dots$ , etc. classical mathematics systems with contradictions to mathematics underlying a topological structure  $G$ , i.e., mathematical combinatorics. All of these discussions show that *a mathematical non-system is a mathematical system inherited a non-trivial topological graph, respect to that of the classical underlying a trivial  $K_1$  or  $K_2$* . Applications of these non-mathematic systems to theoretical physics, such as those of gravitational field, infectious disease control, circulating economical field can be also found in this paper.

All terminologies and notations in this paper are standard. For those not mentioned here, we follow [1] and [19] for algebraic systems, [5] and [6] for algebraic invariant theory, [3] and [32] for differential equations, [4], [8] and [21] for topology and topological graphs and [20], [28]-[31] for Smarandache systems.

## §2. Algebraic Systems

Notice that the graph constructed in Definition 1.2 is in fact on sets  $\Sigma_i$ ,  $1 \leq i \leq m$  with relations on their intersections. Such combinatorial invariants are suitable for algebraic systems. All operations  $\circ : \mathcal{A} \times \mathcal{A} \rightarrow \mathcal{A}$  on a set  $\mathcal{A}$  considered in this section are closed and single valued, i.e.,  $a \circ b$  is uniquely determined in  $\mathcal{A}$ , and it is said to be *Abelian* if  $a \circ b = b \circ a$  for  $\forall a, b \in \mathcal{A}$ .



## 2.1 Non-Algebraic Systems

An algebraic system is a pair  $(\mathcal{A}; \mathcal{R})$  holds with  $a \circ b \in \mathcal{A}$  for  $\forall a, b \in \mathcal{A}$  and  $\circ \in \mathcal{R}$ . A *non-algebraic system*  $\neg(\mathcal{A}; \mathcal{R})$  on an algebraic system  $(\mathcal{A}; \mathcal{R})$  is

**AS<sup>-1</sup>**: *there maybe exist an operation  $\circ \in \mathcal{R}$ , elements  $a, b \in \mathcal{A}$  with  $a \circ b$  undetermined.*

Similarly to classical algebra, an isomorphism on  $\neg(\mathcal{A}; \mathcal{R})$  is such a mapping on  $\mathcal{A}$  that for  $\forall \circ \in \mathcal{R}$ ,

$$h(a \circ b) = h(a) \circ h(b)$$

holds for  $\forall a, b \in \mathcal{A}$  providing  $a \circ b$  is defined in  $\neg(\mathcal{A}; \mathcal{R})$  and  $h(a) = h(b)$  if and only if  $a = b$ . Not loss of generality, let  $\circ \in \mathcal{R}$  be a chosen operation. Then, there exist closed subsets  $\mathcal{C}_i$ ,  $i \geq 1$  of  $\mathcal{A}$ . For instance,

$$\langle a \rangle^\circ = \{a, a \circ a, a \circ a \circ a, \dots, \underbrace{a \circ a \circ \dots \circ a}_k, \dots\}$$

is a closed subset of  $\mathcal{A}$  for  $\forall a \in \mathcal{A}$ . Thus, there exists a decomposition  $\mathcal{A}_1^\circ, \mathcal{A}_2^\circ, \dots, \mathcal{A}_n^\circ$  of  $\mathcal{A}$  such that  $a \circ b \in \mathcal{A}_i^\circ$  for  $\forall a, b \in \mathcal{A}_i^\circ$  for integers  $1 \leq i \leq n$ .

Define a topological graph  $G[\neg(\mathcal{A}; \circ)]$  following:

$$\begin{aligned} V(G[\neg(\mathcal{A}; \circ)]) &= \{\mathcal{A}_1^\circ, \mathcal{A}_2^\circ, \dots, \mathcal{A}_n^\circ\}; \\ E(G[\neg(\mathcal{A}; \circ)]) &= \{(\mathcal{A}_i^\circ, \mathcal{A}_j^\circ) \text{ if } \mathcal{A}_i^\circ \cap \mathcal{A}_j^\circ \neq \emptyset, 1 \leq i, \neq j \leq n\} \end{aligned}$$

with labels

$$\begin{aligned} L: \mathcal{A}_i^\circ \in V(G[\neg(\mathcal{A}; \circ)]) &\rightarrow L(\mathcal{A}_i^\circ) = \mathcal{A}_i^\circ, \\ L: (\mathcal{A}_i^\circ, \mathcal{A}_j^\circ) \in E(G[\neg(\mathcal{A}; \circ)]) &\rightarrow \mathcal{A}_i^\circ \cap \mathcal{A}_j^\circ \text{ for integers } 1 \leq i \neq j \leq n. \end{aligned}$$

For example, let  $\mathcal{A}_1^\circ = \{a, b, c\}$ ,  $\mathcal{A}_2^\circ = \{a, d, f\}$ ,  $\mathcal{A}_3^\circ = \{c, d, e\}$ ,  $\mathcal{A}_4^\circ = \{a, e, f\}$  and  $\mathcal{A}_5^\circ = \{d, e, f\}$ . Calculation shows that  $\mathcal{A}_1^\circ \cap \mathcal{A}_2^\circ = \{a\}$ ,  $\mathcal{A}_1^\circ \cap \mathcal{A}_3^\circ = \{c\}$ ,  $\mathcal{A}_1^\circ \cap \mathcal{A}_4^\circ = \{a\}$ ,  $\mathcal{A}_1^\circ \cap \mathcal{A}_5^\circ = \emptyset$ ,  $\mathcal{A}_2^\circ \cap \mathcal{A}_3^\circ = \{d\}$ ,  $\mathcal{A}_2^\circ \cap \mathcal{A}_4^\circ = \{a\}$ ,  $\mathcal{A}_2^\circ \cap \mathcal{A}_5^\circ = \{d, f\}$ ,  $\mathcal{A}_3^\circ \cap \mathcal{A}_4^\circ = \{e\}$ ,  $\mathcal{A}_3^\circ \cap \mathcal{A}_5^\circ = \{d, e\}$  and  $\mathcal{A}_4^\circ \cap \mathcal{A}_5^\circ = \{e, f\}$ . Then, the labeled graph  $G[\neg(\mathcal{A}; \circ)]$  is shown in Fig.2.

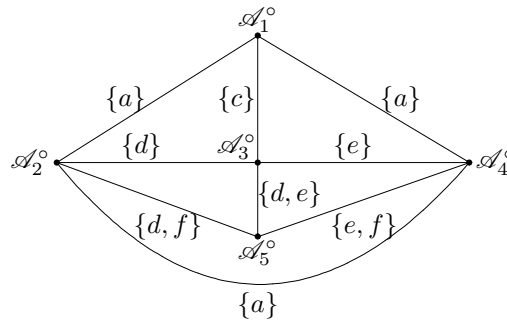

Fig.2

Let  $h : \mathcal{A} \rightarrow \mathcal{A}$  be an isomorphism on  $\neg(\mathcal{A}; \circ)$ . Then  $\forall a, b \in \mathcal{A}_i^\circ$ ,  $h(a) \circ h(b) = h(a \circ b) \in h(\mathcal{A}_i^\circ)$  and  $h(\mathcal{A}_i^\circ) \cap h(\mathcal{A}_j^\circ) = h(\mathcal{A}_i^\circ \cap \mathcal{A}_j^\circ) = \emptyset$  if and only if  $\mathcal{A}_i^\circ \cap \mathcal{A}_j^\circ = \emptyset$  for integers  $1 \leq i \neq j \leq n$ . Whence, if  $G^h[\neg(\mathcal{A}; \circ)]$  defined by

$$\begin{aligned} V(G^h[\neg(\mathcal{A}; \circ)]) &= \{h(\mathcal{A}_1^\circ), h(\mathcal{A}_2^\circ), \dots, h(\mathcal{A}_n^\circ)\}; \\ E(G^h[\neg(\mathcal{A}; \circ)]) &= \{(h(\mathcal{A}_i^\circ), h(\mathcal{A}_j^\circ)) \mid h(\mathcal{A}_i^\circ) \cap h(\mathcal{A}_j^\circ) \neq \emptyset, 1 \leq i, \neq j \leq n\} \end{aligned}$$

with labels

$$\begin{aligned} L^h : h(\mathcal{A}_i^\circ) \in V(G^h[\neg(\mathcal{A}; \circ)]) &\rightarrow L(h(\mathcal{A}_i^\circ)) = h(\mathcal{A}_i^\circ), \\ L^h : (h(\mathcal{A}_i^\circ), h(\mathcal{A}_j^\circ)) \in E(G^h[\neg(\mathcal{A}; \circ)]) &\rightarrow h(\mathcal{A}_i^\circ) \cap h(\mathcal{A}_j^\circ) \end{aligned}$$

for integers  $1 \leq i \neq j \leq n$ . Thus  $h : \mathcal{A} \rightarrow \mathcal{A}$  induces an isomorphism of graph  $h^* : G[\neg(\mathcal{A}; \circ)] \rightarrow G^h[\neg(\mathcal{A}; \circ)]$ . We therefore get the following result.

**Theorem 2.1** *A non-algebraic system  $\neg(\mathcal{A}; \circ)$  in type  $AS^{-1}$  inherits an invariant  $G[\neg(\mathcal{A}; \circ)]$  of labeled graph.*

Let

$$G[\neg(\mathcal{A}; \mathcal{R})] = \bigcup_{\circ \in \mathcal{R}} G[\neg(\mathcal{A}; \circ)]$$

be a topological graph on  $\neg(\mathcal{A}; \mathcal{R})$ . Theorem 2.1 naturally leads to the conclusion for non-algebraic system  $\neg(\mathcal{A}; \mathcal{R})$  following.

**Theorem 2.2** *A non-algebraic system  $\neg(\mathcal{A}; \mathcal{R})$  in type  $AS^{-1}$  inherits an invariant  $G[\neg(\mathcal{A}; \mathcal{R})]$  of topological graph.*

Similarly, we can also discuss *algebraic non-associative systems, algebraic non-Abelian systems* and find inherited invariants  $G[\neg(\mathcal{A}; \circ)]$  of graphs. Usually, we adopt different notations for operations in  $\mathcal{R}$ , which consists of a multi-system  $(\mathcal{A}; \mathcal{R})$ . For example,  $\mathcal{R} = \{+, \cdot\}$  in an algebraic field  $(R; +, \cdot)$ . If we view the operation  $+$  is the same as  $\cdot$ , throw out  $0 \cdot a$ ,  $a \cdot 0$  and  $1 + a$ ,  $a + 1$  for  $\forall a \in R$  in  $R$ , then  $(R; +, \cdot)$  comes to be a non-algebraic system  $(R; \cdot)$  with topological graph  $G[R; \cdot]$  shown in Fig.3.

$$R \setminus \{1\} \bullet \xrightarrow{R \setminus \{0, 1\}} \bullet R \setminus \{0\}$$

**Fig.3**

## 2.2 Non-Groups

A group is an associative system  $(\mathcal{G}; \circ)$  holds with identity and inverse elements for all elements in  $\mathcal{G}$ . Thus, for  $a, b, c \in \mathcal{G}$ ,  $(a \circ b) \circ c = a \circ (b \circ c)$ ,  $\exists 1_{\mathcal{G}} \in \mathcal{G}$  such that  $1_{\mathcal{G}} \circ a = a \circ 1_{\mathcal{G}} = a$  and for  $\forall a \in \mathcal{G}$ ,  $\exists a^{-1} \in \mathcal{A}\mathcal{G}$  such that  $a \circ a^{-1} = 1_{\mathcal{G}}$ . A *non-group*  $\neg(\mathcal{G}; \circ)$  on a group  $(\mathcal{G}; \circ)$  is an

algebraic system in 3 types following:

**AG<sub>1</sub><sup>-1</sup>**: there maybe exist  $a_1, b_1, c_1$  and  $a_2, b_2, c_2 \in \mathcal{G}$  such that  $(a_1 \circ b_1) \circ c_1 = a_1 \circ (b_1 \circ c_1)$  but  $(a_2 \circ b_2) \circ c_2 \neq a_2 \circ (b_2 \circ c_2)$ , also holds with identity  $1_{\mathcal{G}}$  and inverse element  $a^{-1}$  for all elements in  $a \in \mathcal{G}$ .

**AG<sub>2</sub><sup>-1</sup>**: there maybe exist distinct  $1_{\mathcal{G}}, 1'_{\mathcal{G}} \in \mathcal{G}$  such that  $a_1 \circ 1_{\mathcal{G}} = 1_{\mathcal{G}} \circ a_1 = a_1$  and  $a_2 \circ 1'_{\mathcal{G}} = 1'_{\mathcal{G}} \circ a_2 = a_2$  for  $a_1 \neq a_2 \in \mathcal{G}$ , also holds with associative and inverse elements  $a^{-1}$  on  $1_{\mathcal{G}}$  and  $1'_{\mathcal{G}}$  for  $\forall a \in \mathcal{G}$ .

**AG<sub>3</sub><sup>-1</sup>**: there maybe exist distinct inverse elements  $a^{-1}, \dot{a}^{-1}$  for  $a \in \mathcal{G}$ , also holds with associative and identity elements.

Notice that  $(a \circ a) \circ a = a \circ (a \circ a)$  always holds with  $a \in \mathcal{G}$  in an algebraic system. Thus there exists a decomposition  $\mathcal{G}_1, \mathcal{G}_2, \dots, \mathcal{G}_n$  of  $\mathcal{G}$  such that  $(\mathcal{G}_i; \circ)$  is a group for integers  $1 \leq i \leq n$  for Type AG<sub>1</sub><sup>-1</sup>.

Type AG<sub>2</sub><sup>-1</sup> is true only if  $1_{\mathcal{G}} \circ 1'_{\mathcal{G}} \neq 1_{\mathcal{G}}$  and  $\neq 1'_{\mathcal{G}}$ . Thus  $1_{\mathcal{G}}$  and  $1'_{\mathcal{G}}$  are local, not a global identity on  $\mathcal{G}$ . Define

$$\mathcal{G}(1_{\mathcal{G}}) = \{a \in \mathcal{G} \text{ if } a \circ 1_{\mathcal{G}} = 1_{\mathcal{G}} \circ a = a\}.$$

Then  $\mathcal{G}(1_{\mathcal{G}}) \neq \mathcal{G}(1'_{\mathcal{G}})$  if  $1_{\mathcal{G}} \neq 1'_{\mathcal{G}}$ . Denoted by  $I(\mathcal{G})$  the set of all local identities on  $\mathcal{G}$ . Then  $\mathcal{G}(1_{\mathcal{G}})$ ,  $1_{\mathcal{G}} \in I(\mathcal{G})$  is a decomposition of  $\mathcal{G}$  such that  $(\mathcal{G}(1_{\mathcal{G}}); \circ)$  is a group for  $\forall 1_{\mathcal{G}} \in I(\mathcal{G})$ .

Type AG<sub>3</sub><sup>-1</sup> is true only if there are distinct local identities  $1_{\mathcal{G}}$  on  $\mathcal{G}$ . Denoted by  $I(\mathcal{G})$  the set of all local identities on  $\mathcal{G}$ . We can similarly find a decomposition of  $\mathcal{G}$  with group  $(\mathcal{G}(1_{\mathcal{G}}); \circ)$  holds for  $\forall 1_{\mathcal{G}} \in I(\mathcal{G})$  in this type.

Thus, for a non-group  $\neg(\mathcal{G}; \circ)$  of AG<sub>1</sub><sup>-1</sup>-AG<sub>3</sub><sup>-1</sup>, we can always find groups  $(\mathcal{G}_1; \circ), (\mathcal{G}_2; \circ), \dots, (\mathcal{G}_n; \circ)$  for an integer  $n \geq 1$  with  $\mathcal{G} = \bigcup_{i=1}^n \mathcal{G}_i$ . Particularly, if  $(\mathcal{G}; \circ)$  is itself a group, then such a decomposition is clearly exists by its subgroups.

Define a topological graph  $G[\neg(\mathcal{G}; \circ)]$  following:

$$\begin{aligned} V(G[\neg(\mathcal{G}; \circ)]) &= \{\mathcal{G}_1, \mathcal{G}_2, \dots, \mathcal{G}_n\}; \\ E(G[\neg(\mathcal{G}; \circ)]) &= \{(\mathcal{G}_i, \mathcal{G}_j) \text{ if } \mathcal{G}_i \cap \mathcal{G}_j \neq \emptyset, 1 \leq i, \neq j \leq n\} \end{aligned}$$

with labels

$$\begin{aligned} L : \mathcal{G}_i \in V(G[\neg(\mathcal{G}; \circ)]) &\rightarrow L(\mathcal{G}_i) = \mathcal{G}_i, \\ L : (\mathcal{G}_i, \mathcal{G}_j) \in E(G[\neg(\mathcal{G}; \circ)]) &\rightarrow \mathcal{G}_i \cap \mathcal{G}_j \text{ for integers } 1 \leq i \neq j \leq n. \end{aligned}$$

For example, let  $\mathcal{G}_1 = \langle \alpha, \beta \rangle$ ,  $\mathcal{G}_2 = \langle \alpha, \gamma, \theta \rangle$ ,  $\mathcal{G}_3 = \langle \beta, \gamma \rangle$ ,  $\mathcal{G}_4 = \langle \beta, \delta, \theta \rangle$  be 4 free Abelian groups with  $\alpha \neq \beta \neq \gamma \neq \delta \neq \theta$ . Calculation shows that  $\mathcal{G}_1 \cap \mathcal{G}_2 = \langle \alpha \rangle$ ,  $\mathcal{G}_2 \cap \mathcal{G}_3 = \langle \gamma \rangle$ ,  $\mathcal{G}_3 \cap \mathcal{G}_4 = \langle \delta \rangle$ ,  $\mathcal{G}_1 \cap \mathcal{G}_4 = \langle \beta \rangle$  and  $\mathcal{G}_2 \cap \mathcal{G}_4 = \langle \theta \rangle$ . Then, the topological graph  $G[\neg(\mathcal{G}; \circ)]$  is shown in Fig.4.

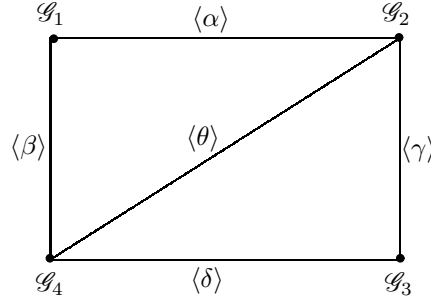

Fig.4

For an isomorphism  $g : \mathcal{G} \rightarrow \mathcal{G}$  on  $\neg(\mathcal{G}; \circ)$ , it naturally induces a 1-1 mapping  $g^* : V(G[\neg(\mathcal{G}; \circ)]) \rightarrow V(G[\neg(\mathcal{G}; \circ)])$  such that each  $g^*(\mathcal{G}_i)$  is also a group and  $g^*(\mathcal{G}_i) \cap g^*(\mathcal{G}_j) \neq \emptyset$  if and only if  $\mathcal{G}_i \cap \mathcal{G}_j \neq \emptyset$  for integers  $1 \leq i \neq j \leq n$ . Thus  $g$  induced an isomorphism  $g^*$  of graph from  $G[\neg(\mathcal{G}; \circ)]$  to  $g^*(G[\neg(\mathcal{G}; \circ)])$ , which implies a conclusion following.

**Theorem 2.3** *A non-group  $\neg(\mathcal{G}; \circ)$  in type  $AG_1^{-1}$ - $AG_3^{-1}$  inherits an invariant  $G[\neg(\mathcal{G}; \circ)]$  of topological graph.*

Similarly, we can discuss more non-groups with some special properties, such as those of *non-Abelian group, non-solvable group, non-nilpotent group* and find inherited invariants  $G[\neg(\mathcal{G}; \circ)]$ . Notice that([19]) any group  $\mathcal{G}$  can be decomposed into disjoint classes  $C(H_1), C(H_2), \dots, C(H_s)$  of conjugate subgroups, particularly, disjoint classes  $Z(a_1), Z(a_2), \dots, Z(a_l)$  of centralizers with  $|C(H_i)| = |\mathcal{G} : N_{\mathcal{G}}(H_i)|$ ,  $|Z(a_j)| = |\mathcal{G} : Z_{\mathcal{G}}(a_j)|$ ,  $1 \leq i \leq s$ ,  $1 \leq j \leq l$  and  $|C(H_1)| + |C(H_2)| + \dots + |C(H_s)| = |\mathcal{G}|$ ,  $|Z(a_1)| + |Z(a_2)| + \dots + |Z(a_l)| = |\mathcal{G}|$ , where  $N_{\mathcal{G}}(H)$ ,  $Z(a)$  denote respectively the normalizer of subgroup  $H$  and centralizer of element  $a$  in group  $\mathcal{G}$ . This fact enables one furthermore to construct topological structures of non-groups with special classes of groups following:

*Replace a vertex  $\mathcal{G}_i$  by  $s_i$  (or  $l_i$ ) isolated vertices labeled with  $C(H_1), C(H_2), \dots, C(H_{s_i})$  (or  $Z(a_1), Z(a_2), \dots, Z(a_{l_i})$ ) in  $G[\neg(\mathcal{G}; \circ)]$  and denoted the resultant by  $\widehat{G}[\neg(\mathcal{G}; \circ)]$ .*

We then get results following on non-groups with special topological structures by Theorem 2.3.

**Theorem 2.4** *A non-group  $\neg(\mathcal{G}; \circ)$  in type  $AG_1^{-1}$ - $AG_3^{-1}$  inherits an invariant  $\widehat{G}[\neg(\mathcal{G}; \circ)]$  of topological graph labeled with conjugate classes of subgroups on its vertices.*

**Theorem 2.5** *A non-group  $\neg(\mathcal{G}; \circ)$  in type  $AG_1^{-1}$ - $AG_3^{-1}$  inherits an invariant  $\widehat{G}[\neg(\mathcal{G}; \circ)]$  of topological graph labeled with Abelian subgroups, particularly, with centralizers of elements in  $\mathcal{G}$  on its vertices.*

Particularly, for a group the following is a readily conclusion of Theorems 2.4 and 2.5.

**Corollary 2.6** *A group  $(\mathcal{G}; \circ)$  inherits an invariant  $\widehat{G}[\mathcal{G}; \circ]$  of topological graph labeled with conjugate classes of subgroups (or centralizers) on its vertices, with  $E(\widehat{G}[\mathcal{G}; \circ]) = \emptyset$*

### 2.3 Non-Rings

A ring is an associative algebraic system  $(R; +, \circ)$  on 2 binary operations “+”, “ $\circ$ ”, hold with an Abelian group  $(R; +)$  and for  $\forall x, y, z \in R$ ,  $x \circ (y + z) = x \circ y + x \circ z$  and  $(x + y) \circ z = x \circ z + y \circ z$ . Denote the identity by  $0_+$ , the inverse of  $a$  by  $-a$  in  $(R; +)$ . A *non-ring*  $\neg(R; +, \circ)$  on a ring  $(R; +, \circ)$  is an algebraic system on operations “+”, “ $\circ$ ” in 5 types following:

**AR<sub>1</sub><sup>-1</sup>**: there maybe exist  $a, b \in R$  such that  $a + b \neq b + a$ , but hold with the associative in  $(R; \circ)$  and a group  $(R; +)$ ;

**AR<sub>2</sub><sup>-1</sup>**: there maybe exist  $a_1, b_1, c_1$  and  $a_2, b_2, c_2 \in R$  such that  $(a_1 \circ b_1) \circ c_1 = a_1 \circ (b_1 \circ c_1)$ ,  $(a_2 \circ b_2) \circ c_2 \neq a_2 \circ (b_2 \circ c_2)$ , but holds with an Abelian group  $(R; +)$ .

**AR<sub>3</sub><sup>-1</sup>**: there maybe exist  $a_1, b_1, c_1$  and  $a_2, b_2, c_2 \in R$  such that  $(a_1 + b_1) + c_1 = a_1 + (b_1 + c_1)$ ,  $(a_2 + b_2) + c_2 \neq a_2 + (b_2 + c_2)$ , but holds with  $(a \circ b) \circ c = a \circ (b \circ c)$ , identity  $0_+$  and  $-a$  in  $(R; +)$  for  $\forall a, b, c \in R$ .

**AR<sub>4</sub><sup>-1</sup>**: there maybe exist distinct  $0_+, 0'_+ \in R$  such that  $a + 0_+ = 0_+ + a = a$  and  $b + 0'_+ = 0'_+ + b = b$  for  $a \neq b \in R$ , but holds with the associative in  $(R; +)$ ,  $(R; \circ)$  and inverse elements  $-a$  on  $0_+, 0'_+$  in  $(R; +)$  for  $\forall a \in R$ .

**AR<sub>5</sub><sup>-1</sup>**: there maybe exist distinct inverse elements  $-a, -\dot{a}$  for  $a \in R$  in  $(R; +)$ , but holds with the associative in  $(R; +)$ ,  $(R; \circ)$  and identity elements in  $(R; +)$ .

Notice that  $(a + a) + a = a + (a + a)$ ,  $a + a = a + a$  and  $a \circ a = a \circ$  always hold in non-ring  $\neg(R; +, \circ)$ . Whence, for Types AR<sub>1</sub><sup>-1</sup> and AR<sub>2</sub><sup>-1</sup>, there exists a decomposition  $R_1, R_2, \dots, R_n$  of  $R$  such that  $a + b = b + a$  and  $(a \circ b) \circ c = a \circ (b \circ c)$  if  $a, b, c \in R_i$ , i.e., each  $(R_i; +, \circ)$  is a ring for integers  $1 \leq i \leq n$ . A similar discussion for Types AG<sub>1</sub><sup>-1</sup>-AG<sub>3</sub><sup>-1</sup> in Section 2.2 also shows such a decomposition  $(R_i; +, \circ)$ ,  $1 \leq i \leq n$  of subrings exists for Types 3 – 5. Define a topological graph  $G[\neg(R; +, \circ)]$  by

$$\begin{aligned} V(G[\neg(R; +, \circ)]) &= \{R_1, R_2, \dots, R_n\}; \\ E(G[\neg(R; +, \circ)]) &= \{(R_i, R_j) \text{ if } R_i \cap R_j \neq \emptyset, 1 \leq i, j \leq n\} \end{aligned}$$

with labels

$$\begin{aligned} L : R_i \in V(G[\neg(R; +, \circ)]) &\rightarrow L(R_i) = R_i, \\ L : (R_i, R_j) \in E(G[\neg(R; +, \circ)]) &\rightarrow R_i \cap R_j \text{ for integers } 1 \leq i \neq j \leq n. \end{aligned}$$

Then, such a topological graph  $G[\neg(R; +, \circ)]$  is also an invariant under isomorphic actions on  $\neg(R; +, \circ)$ . Thus,

**Theorem 2.7** *A non-ring  $\neg(R; +, \circ)$  in types AR<sub>1</sub><sup>-1</sup>-AR<sub>5</sub><sup>-1</sup> inherits an invariant  $G[\neg(R; +, \circ)]$  of topological graph.*

Furthermore, we can consider *non-associative ring, non-integral domain, non-division ring, skew non-field or non-field,  $\dots$* , etc. and find inherited invariants  $G[\neg(R; +, \circ)]$  of graphs. For example, a *non-field*  $\neg(F; +, \circ)$  on a field  $(F; +, \circ)$  is an algebraic system on operations “+”,

“ $\circ$ ” in 8 types following:

**AF<sub>1</sub><sup>-1</sup>**: there maybe exist  $a_1, b_1, c_1$  and  $a_2, b_2, c_2 \in F$  such that  $(a_1 \circ b_1) \circ c_1 = a_1 \circ (b_1 \circ c_1)$ ,  $(a_2 \circ b_2) \circ c_2 \neq a_2 \circ (b_2 \circ c_2)$ , but holds with an Abelian group  $(F; +)$ , identity  $1_\circ$ ,  $a^{-1}$  for  $a \in F$  in  $(F; \circ)$ .

**AF<sub>2</sub><sup>-1</sup>**: there maybe exist  $a_1, b_1, c_1$  and  $a_2, b_2, c_2 \in F$  such that  $(a_1 + b_1) + c_1 = a_1 + (b_1 + c_1)$ ,  $(a_2 + b_2) + c_2 \neq a_2 + (b_2 + c_2)$ , but holds with an Abelian group  $(F; \circ)$ , identity  $1_+$ ,  $-a$  for  $a \in F$  in  $(F; +)$ .

**AF<sub>3</sub><sup>-1</sup>**: there maybe exist  $a, b \in F$  such that  $a \circ b \neq b \circ a$ , but hold with an Abelian group  $(F; +)$ , a group  $(F; \circ)$ ;

**AF<sub>4</sub><sup>-1</sup>**: there maybe exist  $a, b \in F$  such that  $a + b \neq b + a$ , but hold with a group  $(F; +)$ , an Abelian group  $(F; \circ)$ ;

**AF<sub>5</sub><sup>-1</sup>**: there maybe exist distinct  $0_+, 0'_+ \in F$  such that  $a + 0_+ = 0_+ + a = a$  and  $b + 0'_+ = 0'_+ + b = b$  for  $a \neq b \in F$ , but holds with the associative, inverse elements  $-a$  on  $0_+$ ,  $0'_+$  in  $(F; +)$  for  $\forall a \in F$ , an Abelian group  $(F; \circ)$ ;

**AF<sub>6</sub><sup>-1</sup>**: there maybe exist distinct  $1_\circ, 1'_\circ \in F$  such that  $a \circ 1_\circ = 1_\circ \circ a = a$  and  $b \circ 1'_\circ = 1'_\circ \circ b = b$  for  $a \neq b \in F$ , but holds with the associative, inverse elements  $a^{-1}$  on  $1_\circ, 1'_\circ$  in  $(F; \circ)$  for  $\forall a \in F$ , an Abelian group  $(F; +)$ ;

**AF<sub>7</sub><sup>-1</sup>**: there maybe exist distinct inverse elements  $-a, -\dot{a}$  for  $a \in F$  in  $(F; +)$ , but holds with the associative, identity elements in  $(F; +)$ , an Abelian group  $(F; \circ)$ .

**AF<sub>8</sub><sup>-1</sup>**: there maybe exist distinct inverse elements  $a^{-1}, \dot{a}^{-1}$  for  $a \in F$  in  $(F; \circ)$ , but holds with the associative, identity elements in  $(F; \circ)$ , an Abelian group  $(F; +)$ .

Similarly, we can show that there exists a decomposition  $(F_i; +, \circ)$ ,  $1 \leq i \leq n$  of fields for non-fields  $\neg(F; +, \circ)$  in Types  $AF_1^{-1}$ - $AF_8^{-1}$  and find an invariant  $G[\neg(F; +, \circ)]$  of graph.

**Theorem 2.8** *A non-ring  $\neg(F; +, \circ)$  in types  $AF_1^{-1}$ - $AF_8^{-1}$  inherits an invariant  $G[\neg(F; +, \circ)]$  of topological graph.*

## 2.4 Algebraic Combinatorics

All of previous discussions with results in Sections 2.1-2.3 lead to a conclusion alluded in philosophy that a non-algebraic system  $\neg(\mathcal{A}; \mathcal{R})$  constraint with property can be decomposed into algebraic systems with the same constraints, and inherits an invariant  $G[\neg(\mathcal{A}; \mathcal{R})]$  of topological graph labeled with those of algebraic systems, i.e., algebraic combinatorics, which is in accordance with the notion for developing geometry that of Klein's. Thus, a more applicable approach for developing algebra is including non-algebra to algebra by consider various non-algebraic systems constraint with property, but such a process will never be ended if we do not firstly determine all algebraic systems. Even though, a more feasible approach is by its inverse, i.e., algebraic  $G$ -systems following:

**Definition 2.9** *Let  $(\mathcal{A}_1; \mathcal{R}_1), (\mathcal{A}_2; \mathcal{R}_2), \dots, (\mathcal{A}_n; \mathcal{R}_n)$  be algebraic systems. An algebraic  $G$ -system is a topological graph  $G$  with labeling  $L : v \in V(G) \rightarrow L(v) \in \{\mathcal{A}_1, \mathcal{A}_2, \dots, \mathcal{A}_n\}$  and*

$L : (u, v) \in E(G) \rightarrow L(u) \cap L(v)$  with  $L(u) \cap L(v) \neq \emptyset$ , denoted by  $G[\mathcal{A}, \mathcal{R}]$ , where  $\mathcal{A} = \bigcup_{i=1}^n \mathcal{A}_i$  and  $\mathcal{R} = \bigcup_{i=1}^n \mathcal{R}_i$ .

Clearly, if  $G[\mathcal{A}, \mathcal{R}]$  is prescribed, these algebraic systems  $(\mathcal{A}_1; \mathcal{R}_1), (\mathcal{A}_2; \mathcal{R}_2), \dots, (\mathcal{A}_n; \mathcal{R}_n)$  with intersections are determined.

**Problem 2.10** Characterize algebraic  $G$ -systems  $G[\mathcal{A}, \mathcal{R}]$ , such as those of  $G$ -groups,  $G$ -rings, integral  $G$ -domain, skew  $G$ -fields,  $G$ -fields,  $\dots$ , etc., or their combination  $G - \{\text{groups, rings}\}$ ,  $G - \{\text{groups, integral domains}\}$ ,  $G - \{\text{groups, fields}\}$ ,  $G - \{\text{rings, fields}\} \dots$ . Particularly, characterize these  $G$ -algebraic systems for complete graphs  $G = K_2, K_3, K_4$ , path  $P_3, P_4$  or circuit  $C_4$  of order  $\leq 4$ .

In this perspective, classical algebraic systems are nothing else but mostly algebraic  $K_1$ -systems, also a few algebraic  $K_2$ -systems. For example, a field  $(F; +, \cdot)$  is in fact a  $K_2$ -group prescribed by Fig.3.

### §3. Algebraic Equations

All equations discussed in this paper are independent, maybe contain one or several unknowns, not an impossible equality in algebra, for instance  $2^{x+y+z} = 0$ .

#### 3.1 Geometry on Non-Solvable Equations

Let  $(LES_4^1), (LES_4^2)$  be two systems of linear equations following:

$$(LES_4^1) \begin{cases} x = y \\ x = -y \\ x = 2y \\ x = -2y \end{cases} \quad (LES_4^2) \begin{cases} x + y = 1 \\ x + y = 4 \\ x - y = 1 \\ x - y = 4 \end{cases}$$

Clearly, the system  $(LES_4^1)$  is solvable with  $x = 0, y = 0$  but  $(LES_4^2)$  is non-solvable because  $x + y = 1$  is contradicts to that of  $x + y = 4$  and so for  $x - y = 1$  to  $x - y = 4$ . Even so, is the system  $(LES_4^2)$  meaningless in the world? Similarly, is only the solution  $x = 0, y = 0$  of system  $(LES_4^1)$  important to one? Certainly NOT! This view can be readily come into being by all figures on  $\mathbb{R}^2$  of these equations shown in Fig.5. Thus, if we denote by

$$\left\{ \begin{array}{l} L_1 = \{(x, y) \in \mathbb{R}^2 | x = y\} \\ L_2 = \{(x, y) \in \mathbb{R}^2 | x = -y\} \\ L_3 = \{(x, y) \in \mathbb{R}^2 | x = 2y\} \\ L_4 = \{(x, y) \in \mathbb{R}^2 | x = -2y\} \end{array} \right\} \quad \text{and} \quad \left\{ \begin{array}{l} L'_1 = \{(x, y) \in \mathbb{R}^2 | x + y = 1\} \\ L'_2 = \{(x, y) \in \mathbb{R}^2 | x + y = 4\} \\ L'_3 = \{(x, y) \in \mathbb{R}^2 | x - y = 1\} \\ L'_4 = \{(x, y) \in \mathbb{R}^2 | x - y = 4\} \end{array} \right\},$$

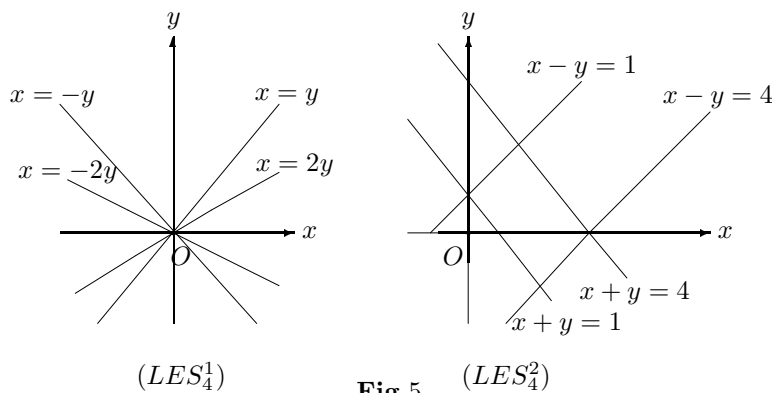

Fig.5

the global behavior of  $(LES_4^1)$ ,  $(LES_4^2)$  are lines  $L_1 - L_4$ , lines  $L'_1 - L'_4$  on  $\mathbb{R}^2$  and

$$L_1 \cap L_2 \cap L_3 \cap L_4 = \{(0,0)\} \text{ but } L'_1 \cap L'_2 \cap L'_3 \cap L'_4 = \emptyset.$$

Generally, let

$$(ES_m) \begin{cases} f_1(x_1, x_2, \dots, x_n) = 0 \\ f_2(x_1, x_2, \dots, x_n) = 0 \\ \dots\dots\dots \\ f_m(x_1, x_2, \dots, x_n) = 0 \end{cases}$$

be a system of algebraic equations in Euclidean space  $\mathbb{R}^n$  for integers  $m, n \geq 1$  with non-empty point set  $S_{f_i} \subset \mathbb{R}^n$  such that  $f_i(x_1, x_2, \dots, x_n) = 0$  for  $(x_1, x_2, \dots, x_n) \in S_{f_i}$ ,  $1 \leq i \leq m$ . Clearly, the system  $(ES_m)$  is non-solvable or not dependent on

$$\bigcap_{i=1}^m S_{f_i} = \emptyset \text{ or } \neq \emptyset.$$

Conversely, let  $\mathcal{G}$  be a geometrical space consisting of  $m$  parts  $\mathcal{G}_1, \mathcal{G}_2, \dots, \mathcal{G}_m$  in  $\mathbb{R}^n$ , where, each  $\mathcal{G}_i$  is determined by a system of algebraic equations

$$\begin{cases} f_1^{[i]}(x_1, x_2, \dots, x_n) = 0 \\ f_2^{[i]}(x_1, x_2, \dots, x_n) = 0 \\ \dots\dots\dots \\ f_{m_i}^{[i]}(x_1, x_2, \dots, x_n) = 0 \end{cases}$$

Then, the system of equations

$$\left. \begin{matrix} f_1^{[i]}(x_1, x_2, \dots, x_n) = 0 \\ f_2^{[i]}(x_1, x_2, \dots, x_n) = 0 \\ \dots\dots\dots \\ f_{m_i}^{[i]}(x_1, x_2, \dots, x_n) = 0 \end{matrix} \right\} 1 \leq i \leq m$$



is non-solvable or not dependent on

$$\bigcap_{i=1}^m \mathcal{G}_i = \emptyset \text{ or } \neq \emptyset.$$

Thus we obtain the following result.

**Theorem 3.1** *The geometrical figure of equation system  $(ES_m)$  is a space  $\mathcal{G}$  consisting of  $m$  parts  $\mathcal{G}_i$  determined by equation  $f_i(x_1, x_2, \dots, x_n) = 0, 1 \leq i \leq m$  in  $(ES_m)$ , and is non-solvable if  $\bigcap_{i=1}^m \mathcal{G}_i = \emptyset$ . Conversely, if a geometrical space  $\mathcal{G}$  consisting of  $m$  parts,  $\mathcal{G}_1, \mathcal{G}_2, \dots, \mathcal{G}_m$ , each of them is determined by a system of algebraic equations in  $\mathbb{R}^n$ , then all of these equations consist a system  $(ES_m)$ , which is non-solvable or not dependent on  $\bigcap_{i=1}^m \mathcal{G}_i = \emptyset$  or not.*

For example, let  $G$  be a planar graph with vertices  $v_1, v_2, v_3, v_4$  and edges  $v_1v_2, v_1v_3, v_2v_3, v_3v_4, v_4v_1$ , shown in Fig.6.

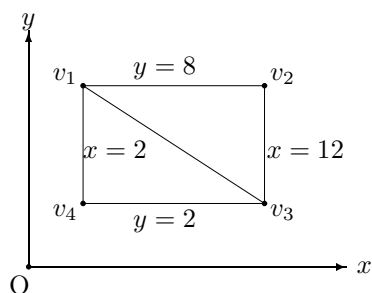

**Fig.6**

Then, a non-solvable system of equations with figure  $G$  on  $\mathbb{R}^2$  consists of

$$(LE_5) \begin{cases} x = 2 \\ y = 8 \\ x = 12 \\ y = 2 \\ 3x + 5y = 46. \end{cases}$$

Thus  $G$  is an underlying graph of non-solvable system  $(LE_5)$ .

**Definition 3.2** *Let  $(ES_{m_i})$  be a solvable system of  $m_i$  equations*

$$\begin{cases} f_1^{[i]}(x_1, x_2, \dots, x_n) = 0 \\ f_2^{[i]}(x_1, x_2, \dots, x_n) = 0 \\ \dots\dots\dots \\ f_{m_i}^{[i]}(x_1, x_2, \dots, x_n) = 0 \end{cases}$$

with a solution space  $S_{f^{[i]}}$  in  $\mathbb{R}^n$  for integers  $1 \leq i \leq m$ . A topological graph  $G[ES_m]$  is defined by

$$\begin{aligned} V(G[ES_m]) &= \{S_{f^{[i]}}, 1 \leq i \leq m\}; \\ E(G[ES_m]) &= \{(S_{f^{[i]}}, S_{f^{[j]}}) \text{ if } S_{f^{[i]}} \cap S_{f^{[j]}} \neq \emptyset, 1 \leq i \neq j \leq m\} \end{aligned}$$

with labels

$$\begin{aligned} L : S_{f^{[i]}} \in V(G[ES_m]) &\rightarrow L(S_{f^{[i]}}) = S_{f^{[i]}}, \\ L : (S_{f^{[i]}}, S_{f^{[j]}}) \in E(G[ES_m]) &\rightarrow S_{f^{[i]}} \cap S_{f^{[j]}} \text{ for integers } 1 \leq i \neq j \leq m. \end{aligned}$$

Applying Theorem 3.1, a conclusion following can be readily obtained.

**Theorem 3.3** A system  $(ES_m)$  consisting of equations in  $(ES_{m_i})$ ,  $1 \leq i \leq m$  is solvable if and only if  $G[ES_m] \simeq K_m$  with  $\emptyset \neq S \subset \bigcap_{i=1}^m S_{f^{[i]}}$ . Otherwise, non-solvable, i.e.,  $G[ES_m] \not\simeq K_m$ , or  $G[ES_m] \simeq K_m$  but  $\bigcap_{i=1}^m S_{f^{[i]}} = \emptyset$ .

Let  $T : (x_1, x_2, \dots, x_n) \rightarrow (x'_1, x'_2, \dots, x'_n)$  be linear transformation determined by an invertible matrix  $[a_{ij}]_{n \times n}$ , i.e.,  $x'_i = a_{i1}x_1 + a_{i2}x_2 + \dots + a_{in}x_n$ ,  $1 \leq i \leq n$  and let  $T(S_{f^{[k]}}) = S'_{f^{[k]}}$  for integers  $1 \leq k \leq m$ . Clearly,  $T : \{S_{f^{[i]}}, 1 \leq i \leq m\} \rightarrow \{S'_{f^{[i]}}, 1 \leq i \leq m\}$  and

$$S'_{f^{[i]}} \cap S'_{f^{[j]}} \neq \emptyset \text{ if and only if } S_{f^{[i]}} \cap S_{f^{[j]}} \neq \emptyset$$

for integers  $1 \leq i \neq j \leq m$ . Consequently, if  $T : (ES_m) \leftarrow ('ES_m)$ , then  $G[ES_m] \simeq G['ES_m]$ . Thus  $T$  induces an isomorphism  $T^*$  of graph from  $G[ES_m]$  to  $G['ES_m]$ , which implies the following result:

**Theorem 3.4** A system  $(ES_m)$  of equations  $f_i(\bar{x}) = 0$ ,  $1 \leq i \leq m$  inherits an invariant  $G[ES_m]$  under the action of invertible linear transformations on  $\mathbb{R}^n$ .

Theorem 3.4 enables one to introduce a definition following for algebraic system  $(ES_m)$  of equations, which expands the scope of algebraic equations.

**Definition 3.5** If  $G[ES_m]$  is the topological graph of system  $(ES_m)$  consisting of equations in  $(ES_{m_i})$  for integers  $1 \leq i \leq m$ , introduced in Definition 3.2, then  $G[ES_m]$  is called a  $G$ -solution of system  $(ES_m)$ .

Thus, for developing the theory of algebraic equations, a central problem in front of one should be:

**Problem 3.6** For an equation system  $(ES_m)$ , determine its  $G$ -solution  $G[ES_m]$ .

For example, the solvable system  $(ES_m)$  in classical algebra is nothing else but a  $K_m$ -solution with  $\bigcap_{i=1}^m S_{f^{[i]}} \neq \emptyset$ , as claimed in Theorem 3.3. The readers are referred to references [22] or [26] for more results on non-solvable equations.

### 3.2 Homogenous Equations

A system  $(ES_m)$  is homogenous if each of its equations  $f_i(x_0, x_1, \dots, x_n)$ ,  $1 \leq i \leq m$  is homogenous, i.e.,

$$f_i(\lambda x_0, \lambda x_1, \dots, \lambda x_n) = \lambda^d f_i(x_0, x_1, \dots, x_n)$$

for a constant  $\lambda$ , denoted by  $(hES_m)$ . For such a system, there are always existing a  $K_m$ -solution with  $\{x_i = 0, 0 \leq i \leq n\} \subset \bigcap_{i=1}^m S_{f[i]}$  and each  $f_i(x_0, x_1, \dots, x_n) = 0$  passes through  $O = \underbrace{(0, 0, \dots, 0)}_{n+1}$  in  $\mathbb{R}^n$ . Clearly, an invertible linear transformation  $T$  action on such a  $K_m$ -solution is also a  $K_m$ -solution.

However, there are meaningless for such a  $K_m$ -solution in projective space  $\mathbb{P}^n$  because  $O \notin \mathbb{P}^n$ . Thus, new invariants for such systems under projective transformations  $(x'_0, x'_1, \dots, x'_n) = [a_{ij}]_{(n+1) \times (n+1)}(x_0, x_1, \dots, x_n)$  should be found, where  $[a_{ij}]_{(n+1) \times (n+1)}$  is invertible. In  $\mathbb{R}^2$ , two lines  $P(x, y), Q(x, y)$  are *parallel* if they are not intersect. But in  $\mathbb{P}^2$ , this parallelism will never appears because the Bézout's theorem claims that any two curves  $P(x, y, z), Q(x, y, z)$  of degrees  $m, n$  without common components intersect precisely in  $mn$  points. However, denoted by  $I(P, Q)$  the set of intersections of homogenous polynomials  $P(\bar{x})$  with  $Q(\bar{x})$  with  $\bar{x} = (x_0, x_1, \dots, x_n)$ . The parallelism in  $\mathbb{R}^n$  can be extended to  $\mathbb{P}^n$  following, which enables one to find invariants on systems homogenous equations.

**Definition 3.7** Let  $P(\bar{x}), Q(\bar{x})$  be two complex homogenous polynomials of degree  $d$  with  $\bar{x} = (x_0, x_1, \dots, x_n)$ . They are said to be *parallel*, denoted by  $P \parallel Q$  if  $d \geq 1$  and there are constants  $a, b, \dots, c$  (not all zero) such that for  $\forall \bar{x} \in I(P, Q)$ ,  $ax_0 + bx_1 + \dots + cx_n = 0$ , i.e., all intersections of  $P(\bar{x})$  with  $Q(\bar{x})$  appear at a hyperplane on  $\mathbb{P}^n \mathbf{C}$ , or  $d = 1$  with all intersections at the infinite  $x_n = 0$ . Otherwise,  $P(\bar{x})$  are not parallel to  $Q(\bar{x})$ , denoted by  $P \not\parallel Q$ .

**Definition 3.8** Let  $P_1(\bar{x}) = 0, P_2(\bar{x}) = 0, \dots, P_m(\bar{x}) = 0$  be homogenous equations in  $(hES_m)$ . Define a topological graph  $G[hES_m]$  in  $\mathbb{P}^n$  by

$$\begin{aligned} V(G[hES_m]) &= \{P_1(\bar{x}), P_2(\bar{x}), \dots, P_m(\bar{x})\}; \\ E(G[hES_m]) &= \{(P_i(\bar{x}), P_j(\bar{x})) | P_i \not\parallel P_j, 1 \leq i, j \leq m\} \end{aligned}$$

with a labeling

$$L : P_i(\bar{x}) \rightarrow P_i(\bar{x}), \quad (P_i(\bar{x}), P_j(\bar{x})) \rightarrow I(P_i, P_j), \text{ where } 1 \leq i \neq j \leq m.$$

For any system  $(hES_m)$  of homogenous equations,  $G[hES_m]$  is an indeed invariant under the action of invertible linear transformations  $T$  on  $\mathbb{P}^n$ . By definition in [6], a *covariant*  $C(a_{\bar{k}}, \bar{x})$  on homogenous polynomials  $P(\bar{x})$  is a polynomial function of coefficients  $a_{\bar{k}}$  and variables  $\bar{x}$ . We furthermore find a topological invariant on covariants following.

**Theorem 3.9** Let  $(hES_m)$  be a system consisting of covariants  $C_i(a_{\bar{k}}, \bar{x})$  on homogenous polynomials  $P_i(\bar{x})$  for integers  $1 \leq i \leq m$ . Then, the graph  $G[hES_m]$  is a covariant under the action of invertible linear transformations  $T$ , i.e., for  $\forall C_i(a_{\bar{k}}, \bar{x}) \in (ES_m)$ , there is  $C_{i'}(a_{\bar{k}}, \bar{x}) \in$

$(ES_m)$  with

$$C_{i'}(a'_{\bar{k}}, \bar{x}') = \Delta^p C_i(a_{\bar{k}}, \bar{x})$$

holds for integers  $1 \leq i \leq m$ , where  $p$  is a constant and  $\Delta$  is the determinant of  $T$ .

*Proof* Let  $G^T[hES_m]$  be the topological graph on transformed system  $T(hES_m)$  defined in Definition 3.8. We show that the invertible linear transformation  $T$  naturally induces an isomorphism between graphs  $G[hES_m]$  and  $G^T[hES_m]$ . In fact,  $T$  naturally induces a mapping  $T^* : G[hES_m] \rightarrow G^T[hES_m]$  on  $\mathbb{P}^n$ . Clearly,  $T^* : V(G[hES_m]) \rightarrow V(G^T[hES_m])$  is  $1-1$ , also onto by definition. In projective space  $\mathbb{P}^n$ , a line is transferred to a line by an invertible linear transformation. Therefore,  $C_u^T \parallel C_v^T$  in  $T(hES_m)$  if and only if  $C_u \parallel C_v$  in  $(hES_m)$ , which implies that  $(C_u^T, C_v^T) \in E(G^T[hES_m])$  if and only if  $(C_u, C_v) \in E(G[hES_m])$ . Thus,  $G[hES_m] \simeq G^T[hES_m]$  with an isomorphism  $T^*$  of graph.

Notice that  $I(C_u^T, C_v^T) = T(I(C_u, C_v))$  for  $\forall (C_u, C_v) \in E(G[hES_m])$ . Consequently, the induced mapping

$$T^* : V(G[hES_m]) \rightarrow V(G^T[hES_m]), \quad E(G[hES_m]) \rightarrow E(G^T[hES_m])$$

is commutative with that of labeling  $L$ , i.e.,  $T^* \circ L = L \circ T^*$ . Thus,  $T^*$  is an isomorphism from topological graph  $G[hES_m]$  to  $G^T[hES_m]$ .  $\square$

Particularly, let  $p = 0$ , i.e.,  $(ES_m)$  consisting of homogenous polynomials  $P_1(\bar{x}), P_2(\bar{x}), \dots, P_m(\bar{x})$  in Theorem 3.9. Then we get a result on systems of homogenous equations following.

**Corollary 3.10** *A system  $(hES_m)$  of homogenous equations  $f_i(\bar{x}) = 0, 1 \leq i \leq m$  inherits an invariant  $G[hES_m]$  under the action of invertible linear transformations on  $\mathbb{P}^n$ .*

Thus, for homogenous equation systems  $(hES_m)$ , the  $G$ -solution in Problem 3.6 should be substituted by  $G[hES_m]$ -solution.

## §4. Differential Equations

### 4.1 Non-Solvable Ordinary Differential Equations

For integers  $m, n \geq 1$ , let

$$\dot{X} = F_i(X), \quad 1 \leq i \leq m \quad (DES_m^1)$$

be a differential equation system with continuous  $F_i : \mathbf{R}^n \rightarrow \mathbf{R}^n$ ,  $\dot{X} = \frac{dX}{dt}$  such that  $F_i(\bar{0}) = \bar{0}$ , particularly, let

$$\dot{X} = A_1 X, \dots, \dot{X} = A_k X, \dots, \dot{X} = A_m X \quad (LDES_m^1)$$

be a linear ordinary differential equation system of first order with

$$\dot{X} = (\dot{x}_1, \dot{x}_2, \dots, \dot{x}_n)^t = \left( \frac{dx_1}{dt}, \frac{dx_2}{dt}, \dots, \frac{dx_n}{dt} \right)$$

and

$$\begin{cases} x^{(n)} + a_{11}^{[0]}x^{(n-1)} + \dots + a_{1n}^{[0]}x = 0 \\ x^{(n)} + a_{21}^{[0]}x^{(n-1)} + \dots + a_{2n}^{[0]}x = 0 \\ \dots\dots\dots \\ x^{(n)} + a_{m1}^{[0]}x^{(n-1)} + \dots + a_{mn}^{[0]}x = 0 \end{cases} \quad (LDE_m^n)$$

a linear differential equation system of order  $n$  with

$$A_k = \begin{bmatrix} a_{11}^{[k]} & a_{12}^{[k]} & \dots & a_{1n}^{[k]} \\ a_{21}^{[k]} & a_{22}^{[k]} & \dots & a_{2n}^{[k]} \\ \dots & \dots & \dots & \dots \\ a_{n1}^{[k]} & a_{n2}^{[k]} & \dots & a_{nn}^{[k]} \end{bmatrix} \quad \text{and} \quad X = \begin{bmatrix} x_1(t) \\ x_2(t) \\ \dots \\ x_n(t) \end{bmatrix},$$

where,  $x^{(n)} = \frac{d^n x}{dt^n}$ , all  $a_{ij}^{[k]}$ ,  $0 \leq k \leq m$ ,  $1 \leq i, j \leq n$  are numbers. Such a system ( $DES_m^1$ ) or ( $LDES_m^1$ ) (or ( $LDE_m^n$ )) are called *non-solvable* if there are no function  $X(t)$  (or  $x(t)$ ) hold with ( $DES_m^1$ ) or ( $LDES_m^1$ ) (or ( $LDE_m^n$ )) unless constants. For example, the following differential equation system

$$(LDE_6^2) \begin{cases} \ddot{x} - 3\dot{x} + 2x = 0 & (1) \\ \ddot{x} - 5\dot{x} + 6x = 0 & (2) \\ \ddot{x} - 7\dot{x} + 12x = 0 & (3) \\ \ddot{x} - 9\dot{x} + 20x = 0 & (4) \\ \ddot{x} - 11\dot{x} + 30x = 0 & (5) \\ \ddot{x} - 7\dot{x} + 6x = 0 & (6) \end{cases}$$

is a non-solvable system.

According to theory of ordinary differential equations ([32]), any linear differential equation system ( $LDES_1^1$ ) of first order in ( $LDES_m^1$ ) or any differential equation ( $LDE_1^n$ ) of order  $n$  with complex coefficients in ( $LDE_m^n$ ) are solvable with a solution basis  $\mathcal{B} = \{ \bar{\beta}_i(t) \mid 1 \leq i \leq n \}$  such that all general solutions are linear generated by elements in  $\mathcal{B}$ .

Denoted the solution basis of systems ( $DES_m^1$ ) or ( $LDES_m^1$ ) (or ( $LDE_m^n$ )) of ordinary differential equations by  $\mathcal{B}_1, \mathcal{B}_2, \dots, \mathcal{B}_m$  and define a topological graph  $G[DES_m^1]$  or  $G[LDES_m^1]$  (or  $G[LDE_m^n]$ ) in  $\mathbb{R}^n$  by

$$\begin{aligned} V(G[DES_m^1]) &= V(G[LDES_m^1]) = V(G[LDE_m^n]) = \{ \mathcal{B}_1, \mathcal{B}_2, \dots, \mathcal{B}_m \}; \\ E(G[DES_m^1]) &= E(G[LDES_m^1]) = E(G[LDE_m^n]) \\ &= \{ (\mathcal{B}_i, \mathcal{B}_j) \mid \text{if } \mathcal{B}_i \cap \mathcal{B}_j \neq \emptyset, 1 \leq i, j \leq m \} \end{aligned}$$

with a labeling

$$L : \mathcal{B}_i \rightarrow \mathcal{B}_i, \quad (\mathcal{B}_i, \mathcal{B}_j) \rightarrow \mathcal{B}_i \cap \mathcal{B}_j \text{ for } 1 \leq i \neq j \leq m.$$

Let  $T$  be a linear transformation on  $\mathbb{R}^n$  determined by an invertible matrix  $[a_{ij}]_{n \times n}$ . Let

$$T : \{\mathcal{B}_i, 1 \leq i \leq m\} \rightarrow \{\mathcal{B}'_i, 1 \leq i \leq m\}.$$

It is clear that  $\mathcal{B}'_i$  is the solution basis of the  $i$ th transformed equation in  $(DES^1_m)$  or  $(LDES^1_m)$  (or  $(LDE^n_m)$ ), and  $\mathcal{B}'_i \cap \mathcal{B}'_j \neq \emptyset$  if and only if  $\mathcal{B}_i \cap \mathcal{B}_j \neq \emptyset$ . Thus  $T$  naturally induces an isomorphism  $T^*$  of graph with  $T^* \circ L = L \circ T^*$  on labeling  $L$ .

**Theorem 4.1** *A system  $(DES^1_m)$  or  $(LDES^1_m)$  (or  $(LDE^n_m)$ ) of ordinary differential equations inherits an invariant  $G[DES^1_m]$  or  $G[LDES^1_m]$  (or  $G[LDE^n_m]$ ) under the action of invertible linear transformations on  $\mathbb{R}^n$ .*

Clearly, if the topological graph  $G[DES^1_m]$  or  $G[LDES^1_m]$  (or  $G[LDE^n_m]$ ) are determined, the global behavior of solutions of systems  $(DES^1_m)$  or  $(LDES^1_m)$  (or  $(LDE^n_m)$ ) in  $\mathbb{R}^n$  are readily known. Such graphs are called respectively  $G[DES^1_m]$ -solution or  $G[LDES^1_m]$ -solution (or  $G[LDE^n_m]$ -solution) of systems of  $(DES^1_m)$  or  $(LDES^1_m)$  (or  $(LDE^n_m)$ ). Thus, for developing ordinary differential equation theory, an interesting problem should be:

**Problem 4.2** *For a system of  $(DES^1_m)$  (or  $(LDES^1_m)$ , or  $(LDE^n_m)$ ) of ordinary differential equations, determine its  $G[DES^1_m]$ -solution ( or  $G[LDES^1_m]$ -solution, or  $G[LDE^n_m]$ -solution).*

For example, the topological graph  $G[LDE^2_6]$  of system  $(LDE^2_6)$  of linear differential equation of order 2 in previous is shown in Fig.7.

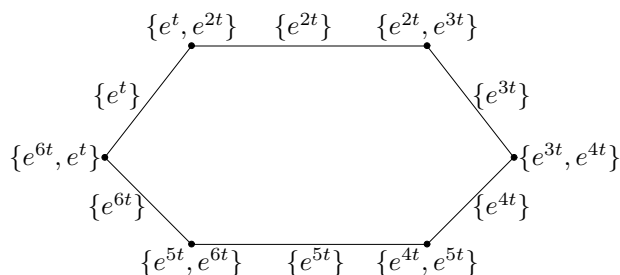

Fig.7

### 4.2 Non-Solvable Partial Differential Equations

Let  $L_1, L_2, \dots, L_m$  be  $m$  partial differential operators of first order (linear or non-linear) with

$$L_k = \sum_{i=1}^n a_{ki} \frac{\partial}{\partial x_i}, \quad 1 \leq k \leq m.$$

Then the system of partial differential equations

$$L_i[u(x_1, x_2, \dots, x_n)] = h_i, \quad 1 \leq i \leq m, \quad (PDES_m)$$

or the Cauchy problem

$$\begin{cases} L_i[u] = h_i \\ u(x_1, x_2, \dots, x_{n-1}, x_n^0) = \varpi_i, \quad 1 \leq i \leq m \end{cases} \quad (PDES_m^C)$$

is *non-solvable* if there are no function  $u(x_1, \dots, x_n)$  on a domain  $D \subset \mathbb{R}^n$  with  $(PDES_m)$  or  $(PDES_m^C)$  holds, where  $h_i$ ,  $1 \leq i \leq m$  and  $\varpi_i$ ,  $1 \leq i \leq m$  are all continuous functions on  $D \subset \mathbb{R}^n$ .

Clearly, the  $i$ th partial differential equation is solvable [3]. Denoted by  $S_i^0$  the solution of  $i$ th equation in  $(PDES_m)$  or  $(DEPS_m^C)$ . Then the system  $(PDES_m)$  or  $(DEPS_m^C)$  of partial differential equations is solvable only if  $\bigcap_{i=1}^m S_i^0 \neq \emptyset$ . Because  $u : \mathbb{R}^n \rightarrow \mathbb{R}^n$  is differentiable, so the  $(PDES_m)$  or  $(DEPS_m^C)$  is solvable only if  $\bigcap_{i=1}^m S_i^0$  is a non-empty functional set on a domain  $D \subset \mathbb{R}^n$ . Otherwise, non-solvable, i.e.,  $\bigcap_{i=1}^m S_i^0 = \emptyset$  for any domain  $D \subset \mathbb{R}^n$ .

Define a topological graph  $G[PDES_m]$  or  $G[DEPS_m^C]$  in  $\mathbb{R}^n$  by

$$\begin{aligned} V(G[PDES_m]) &= V(G[DEPS_m^C]) = \{S_i^0, 1 \leq i \leq m\}; \\ E(G[PDES_m]) &= E(G[DEPS_m^C]) \\ &= \{(S_i^0, S_j^0) \text{ if } S_i^0 \cap S_j^0 \neq \emptyset, 1 \leq i, j \leq m\} \end{aligned}$$

with a labeling

$$L : S_i^0 \rightarrow S_i^0, \quad (S_i^0, S_j^0) \in E(G[PDES_m]) = E(G[DEPS_m^C]) \rightarrow S_i^0 \cap S_j^0$$

for  $1 \leq i \neq j \leq m$ . Similarly, if  $T$  is an invertible linear transformation on  $\mathbb{R}^n$ , then  $T(S_i^0)$  is the solution of  $i$ th transformed equation in  $(PDES_m)$  or  $(DEPS_m^C)$ , and  $T(S_i^0) \cap T(S_j^0) \neq \emptyset$  if and only if  $S_i^0 \cap S_j^0 \neq \emptyset$ . Accordingly,  $T$  induces an isomorphism  $T^*$  of graph with  $T^* \circ L = L \circ T^*$  holds on labeling  $L$ . We get the following result.

**Theorem 4.3** *A system  $(PDES_m)$  or  $(DEPS_m^C)$  of partial differential equations of first order inherits an invariant  $G[PDES_m]$  or  $G[DEPS_m^C]$  under the action of invertible linear transformations on  $\mathbb{R}^n$ .*

Such a topological graph  $G[PDES_m]$  or  $G[DEPS_m^C]$  are said to be the  $G[PDES_m]$ -solution or  $G[DEPS_m^C]$ -solution of systems  $(PDES_m)$  and  $(DEPS_m^C)$ , respectively. For example, the  $G[DEPS_3^C]$ -solution of Cauchy problem

$$\begin{cases} u_t + au_x = 0 \\ u_t + xu_x = 0 \\ u_t + au_x + e^t = 0 \\ u|_{t=0} = \phi(x) \end{cases} \quad (DEPS_3^C)$$

is shown in Fig.8

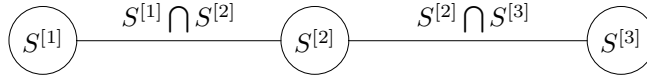

**Fig.8**

Clearly, system  $(DEPS_3^C)$  is contradictory because  $e^t \neq 0$  for  $t$ . However,

$$\begin{cases} u_t + au_x = 0 \\ u|_{t=0} = \phi(x) \end{cases} \quad \begin{cases} u_t + xu_x = 0 \\ u|_{t=0} = \phi(x) \end{cases} \quad \text{and} \quad \begin{cases} u_t + au_x + e^t = 0 \\ u|_{t=0} = \phi(x) \end{cases}$$

are solvable with respective solutions  $S^{[1]} = \{\phi(x - at)\}$ ,  $S^{[2]} = \{\phi(\frac{x}{e^t})\}$  and  $S^{[3]} = \{\phi(x - at) - e^t + 1\}$ , and  $S^{[1]} \cap S^{[2]} = \{\phi(x - at) = \phi(\frac{x}{e^t})\}$ ,  $S^{[2]} \cap S^{[3]} = \{\phi(\frac{x}{e^t}) = \phi(x - at) - e^t + 1\}$ , but  $S^{[1]} \cap S^{[3]} = \emptyset$ .

Similar to ordinary case, an interesting problem on partial differential equations is the following:

**Problem 4.4** For a system of  $(PDES_m)$  or  $(DEPS_m^C)$  of partial differential equations, determine its  $G[PDES_m]$ -solution or  $G[DEPS_m^C]$ -solution.

It should be noted that for an algebraically contradictory linear system

$$\begin{cases} F_i(x_1, \dots, x_n, u, p_1, \dots, p_n) = 0 \\ F_j(x_1, \dots, x_n, u, p_1, \dots, p_n) = 0, \end{cases}$$

if

$$F_k(x_1, \dots, x_n, u, p_1, \dots, p_n) = 0$$

is contradictory to one of there two partial differential equations, then it must be contradictory to another. This fact enables one to classify equations in  $(LPDES_m)$  by the contradictory property and determine  $G[LPDES_m^C]$ . Thus if  $\mathcal{C}_1, \dots, \mathcal{C}_l$  are maximal contradictory classes for equations in  $(LPDES)$ , then  $G[LPDES_m^C] \simeq K(\mathcal{C}_1, \dots, \mathcal{C}_l)$ , i.e., an  $l$ -partite complete graph. Accordingly, all  $G[LPDES_m^C]$ -solutions of linear systems  $(LPDES_m)$  are nothing else but  $K(\mathcal{C}_1, \dots, \mathcal{C}_s)$ -solutions. More behaviors on non-solvable ordinary or partial differential equations of first order, for instance the global stability can be found in references [25]-[27].

### 4.3 Equation's Combinatorics

All these discussions in Sections 3 and 4.2 – 4.3 lead to a conclusion that a non-solvable system  $(ES)$  of equations in  $n$  variables inherits an invariant  $G[ES]$  of topological graph labeled with those of individually solutions, if it is individually solvable, i.e., equation's combinatorics by view it with the topological graph  $G[ES]$  in  $\mathbb{R}^n$ . Thus, for holding the global behavior of a system  $(ES)$  of equations, the right way is not just to determine it is solvable or not, but its



$G[ES]$ -solution. Such a  $G[ES]$ -solution is existent by philosophy and enables one to include non-solvable equations, no matter what they are algebraic, differential, integral or operator equations to mathematics by  $G$ -system following:

**Definition 4.5** A  $G$ -system  $(ES_m)$  of equations  $O_i(\overline{X}) = \overline{0}$ ,  $1 \leq i \leq m$  with constraints  $\mathcal{C}$  is a topological graph  $G$  with labeling  $L : v \in V(G) \rightarrow L(v) \in \{S_{O_i}; 1 \leq i \leq m\}$  and  $L : (u, v) \in E(G) \rightarrow L(u) \cap L(v)$  with  $L(u) \cap L(v) \neq \emptyset$ , denoted by  $G[ES_m]$ , where,  $S_{O_i}$  is the solution space of equation  $O_i(\overline{X}) = \overline{0}$  with constraints  $\mathcal{C}$  for integers  $1 \leq i \leq m$ .

Thus, holding the true face of a thing  $T$  characterized by a system  $(ES_m)$  of equations needs one to determine its  $G$ -system, i.e.,  $G[ES_m]$ -solution, not only solvable or not for its objective reality.

**Problem 4.6** Determine  $G[ES_m]$  for equation systems  $(ES_m)$ , such as those of algebraic, differential, integral, operator equations, or their combination, or conversely, characterize  $G$ -systems of equations for given graphs  $G$ , for example, these  $G$ -systems of equations for complete graphs  $G = K_m$ , complete bipartite graph  $K(n_1, n_2)$  with  $n_1 + n_2 = m$ , path  $P_{m-1}$  or circuit  $C_m$ .

By this view, a solvable system  $(ES_m)$  of equations in classical mathematics is nothing else but such a  $K_m$ -system with  $\bigcap_{e \in E(K_m)} L(e) \neq \emptyset$ . However, as we known, more systems of equations established on characters  $\mu_i$ ,  $1 \leq i \leq n$  for a thing  $T$  are non-solvable with contradictions if  $n \geq 2$ . It is nearly impossible to solve all those systems in classical mathematics. Even so, its  $G$ -systems reveals behaviors of thing  $T$  to human beings.

## §5. Geometry

As what one sees with an immediately form on things, the geometry proves to be one of applicable means for portraying things by its homogeneity with distinction. Nevertheless, the non-geometry can also contributes describing things complying with the Erlangen Programme that of Klein.

### 5.1 Non-Spaces

Let  $\mathcal{K}^n = \{(x_1, x_2, \dots, x_n)\}$  be an  $n$ -dimensional Euclidean ( affine or projective ) space with a normal basis  $\overline{e}_i$ ,  $1 \leq i \leq n$ ,  $\overline{x} \in \mathcal{K}^n$  and let  $\overrightarrow{V}_{\overline{x}}$ ,  $\overline{x}\overrightarrow{V}$  be two orientation vectors with end or initial point at  $\overline{x}$ . Such as those shown in Fig.9.

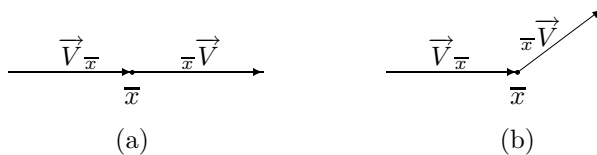

Fig.9

For point  $\forall \bar{x} \in \mathcal{K}^n$ , we associate it with an invertible linear mapping

$$\mu : \{\bar{\epsilon}_1, \bar{\epsilon}_2, \dots, \bar{\epsilon}_n\} \rightarrow \{\bar{\epsilon}'_1, \bar{\epsilon}'_2, \dots, \bar{\epsilon}'_n\}$$

such that  $\mu(\bar{\epsilon}_i) = \bar{\epsilon}'_i$ ,  $1 \leq i \leq n$ , called its *weight*, i.e.,

$$(\bar{\epsilon}'_1, \bar{\epsilon}'_2, \dots, \bar{\epsilon}'_n) = [a_{ij}]_{n \times n} (\bar{\epsilon}_1, \bar{\epsilon}_2, \dots, \bar{\epsilon}_n)^t$$

where,  $[a_{ij}]_{n \times n}$  is an invertible matrix. Such a space is a weighted space on points in  $\mathcal{K}^n$ , denoted by  $(\mathcal{K}^n, \mu)$  with  $\mu : \bar{x} \rightarrow \mu(\bar{x}) = [a_{ij}]_{n \times n}$ . Clearly, if  $\mu(\bar{x}_1) = [a'_{ij}]$ ,  $\mu(\bar{x}_2) = [a''_{ij}]$ , then  $\mu(\bar{x}_1) = \mu(\bar{x}_2)$  if and only if there exists a constant  $\lambda$  such that  $[a'_{ij}]_{n \times n} = [\lambda a''_{ij}]_{n \times n}$ , and  $(\mathcal{K}^n, \mu) = \mathbb{R}^n$  ( $\mathbb{A}^n$  or  $\mathbb{P}^n$ ), i.e., *n-dimensional Euclidean (affine or projective space)* if and only if  $[a_{ij}]_{n \times n} = I_{n \times n}$  for  $\forall \bar{x} \in \mathcal{K}^n$ . Otherwise, *non-Euclidean, non-affine or non-projective space*, abbreviated to *non-space*.

Notice that  $[a'_{ij}]_{n \times n} = [\lambda a''_{ij}]_{n \times n}$  is an equivalent relation on invertible  $n \times n$  matrixes. Thus, for  $\forall \bar{x}_0 \in \mathcal{K}^n$ , define

$$\mathcal{C}(\bar{x}_0) = \{\bar{x} \in \mathcal{K}^n \mid \mu(\bar{x}) = \lambda \mu(\bar{x}_0), \lambda \in \mathbb{R}\},$$

an *equivalent set* of points to  $\bar{x}_0$ . Then there exist representatives  $\mathcal{C}_\kappa, \kappa \in \Lambda$  constituting a partition of  $\mathcal{K}^n$  in all equivalent sets  $\mathcal{C}(\bar{x}), \bar{x} \in \mathcal{K}^n$  of points, i.e.,

$$\mathcal{K}^n = \bigcup_{\kappa \in \Lambda} \mathcal{C}_\kappa \quad \text{with} \quad \mathcal{C}_{\kappa_1} \cap \mathcal{C}_{\kappa_2} = \emptyset \quad \text{for} \quad \kappa_1, \kappa_2 \in \Lambda \quad \text{if} \quad \kappa_1 \neq \kappa_2,$$

where  $\Lambda$  maybe countable or uncountable.

Let  $\mu(\bar{x}) = [a_{ij}]_{n \times n} = A_\kappa$  for  $\bar{x} \in \mathcal{C}_\kappa$ . For viewing behaviors of orientation vectors in an equivalent set  $\mathcal{C}_\kappa$  of points, define  $\mu_{A_\kappa} : \mathcal{K}^n \rightarrow \mu_{A_\kappa}(\mathcal{K}^n)$  by  $\mu_{A_\kappa}(\bar{x}) = A_\kappa$ . Then  $(\mathcal{K}^n, \mu_{A_\kappa})$  is also a non-space if  $A_\kappa \neq I_{n \times n}$ . However,  $(\mathcal{K}^n, \mu_{A_\kappa})$  approximates to  $\mathcal{K}^n$  with homogeneity because each orientation vector only turns a same direction passing through a point. Thus,  $(\mathcal{K}^n, \mu_{A_\kappa})$  can be viewed as space  $\mathcal{K}^n$ , denoted by  $\mathcal{K}_{\mu_{A_\kappa}}^n$ . Define a topological graph  $G[\mathcal{K}^n, \mu]$  by

$$\begin{aligned} V(G[\mathcal{K}^n, \mu]) &= \{\mathcal{K}_{\mu_\kappa}^n, \kappa \in \Lambda\}; \\ E(G[\mathcal{K}^n, \mu]) &= \{(\mathcal{K}_{\mu_{\kappa_1}}^n, \mathcal{K}_{\mu_{\kappa_2}}^n) \text{ if } \mathcal{K}_{\mu_{\kappa_1}}^n \cap \mathcal{K}_{\mu_{\kappa_2}}^n \neq \emptyset, \kappa_1, \kappa_2 \in \Lambda, \kappa_1 \neq \kappa_2\} \end{aligned}$$

with labels

$$\begin{aligned} L : \mathcal{K}_{\mu_\kappa}^n \in V(G[\mathcal{K}^n, \mu]) &\rightarrow \mathcal{K}_{\mu_\kappa}^n, \\ L : (\mathcal{K}_{\mu_{\kappa_1}}^n, \mathcal{K}_{\mu_{\kappa_2}}^n) \in E(G[\mathcal{K}^n, \mu]) &\rightarrow \mathcal{K}_{\mu_{\kappa_1}}^n \cap \mathcal{K}_{\mu_{\kappa_2}}^n, \quad \kappa_1 \neq \kappa_2 \in \Lambda. \end{aligned}$$

Then, we get an overview on  $(\mathcal{K}^n, \mu)$  with Euclidean spaces  $\mathcal{K}_{\mu_\kappa}^n, \kappa \in \Lambda$  by combinatorics. Clearly,  $\mathcal{K}^n \cap \mathcal{K}_{\mu_\kappa}^n = \mathcal{C}_\kappa$  and  $\mathcal{K}_{\mu_{\kappa_1}}^n \cap \mathcal{K}_{\mu_{\kappa_2}}^n = \emptyset$  if none of  $\mathcal{K}_{\mu_{\kappa_1}}^n, \mathcal{K}_{\mu_{\kappa_2}}^n$  being  $\mathcal{K}^n$ . Thus,  $G[\mathcal{K}^n, \mu] \simeq K_{1, |\Lambda|-1}$ , a star with center  $\mathcal{K}^n$ , such as those shown in Fig.10. Otherwise,

$G[\mathcal{K}^n, \mu] \simeq \overline{K}_{|\Lambda|}$ , i.e.,  $|\Lambda|$  isolated vertices, which can be turned into  $K_{1,|\Lambda|}$  by adding an imaginary center vertex  $\mathcal{K}^n$ .

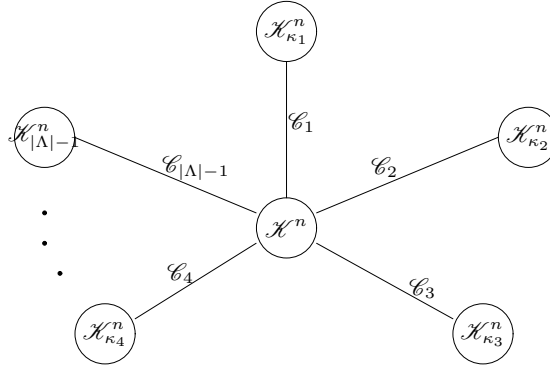

**Fig.10**

Let  $T$  be an invertible linear transformation on  $\mathcal{K}^n$  determined by  $(\overline{x}^t) = [\alpha_{ij}]_{n \times n} (\overline{x})^t$ . Clearly,  $T : \mathcal{K}^n \rightarrow \mathcal{K}^n$ ,  $\mathcal{K}_{\mu_\kappa}^n \rightarrow T(\mathcal{K}_\kappa^n)$  and  $T(\mathcal{K}_{\kappa_1}^n) \cap T(\mathcal{K}_{\kappa_2}^n) \neq \emptyset$  if and only if  $\mathcal{K}_{\kappa_1}^n \cap \mathcal{K}_{\kappa_2}^n \neq \emptyset$ . Furthermore, one of  $T(\mathcal{K}_{\kappa_1}^n)$ ,  $T(\mathcal{K}_{\kappa_2}^n)$  should be  $\mathcal{K}^n$ . Thus  $T$  induces an isomorphism  $T^*$  from  $G[\mathcal{K}^n, \mu]$  to  $G[T(\mathcal{K}^n), \mu]$  of graph. Accordingly, we know the result following.

**Theorem 5.1** *An  $n$ -dimensional non-space  $(\mathcal{K}^n, \mu)$  inherits an invariant  $G[\mathcal{K}^n, \mu]$ , i.e., a star  $K_{1,|\Lambda|-1}$  or  $K_{1,|\Lambda|}$  under the action of invertible linear transformations on  $\mathbb{K}^n$ , where  $\Lambda$  is an index set such that all equivalent sets  $\mathcal{C}_\kappa, \kappa \in \Lambda$  constitute a partition of space  $\mathcal{K}^n$ .*

## 5.2 Non-Manifolds

Let  $M$  be an  $n$ -dimensional manifold with an alta  $\mathcal{A} = \{(U_\lambda; \varphi_\lambda) \mid \lambda \in \Lambda\}$ , where  $\varphi_\lambda : U_\lambda \rightarrow \mathbb{R}^n$  is a homeomorphism with countable  $\Lambda$ . A *non-manifold*  $\neg M$  on  $M$  is such a topological space with  $\varphi : U_\lambda \rightarrow \mathbb{R}^{n_\lambda}$  for integers  $n_\lambda \geq 1$ ,  $\lambda \in \Lambda$ , which is a special but more applicable case of non-space  $(\mathbb{R}^n, \mu)$ . Clearly, if  $n_\lambda = n$  for  $\lambda \in \Lambda$ ,  $\neg M$  is nothing else but an  $n$ -manifold.

For an  $n$ -manifold  $M$ , each  $U_\lambda$  is itself an  $n$ -manifold for  $\lambda \in \Lambda$  by definition. Generally, let  $M_\lambda$  be an  $n_\lambda$ -manifold with an alta  $\mathcal{A}_\lambda = \{(U_{\lambda\kappa}; \varphi_{\lambda\kappa}) \mid \kappa \in \Lambda_\lambda\}$ , where  $\varphi_{\lambda\kappa} : U_{\lambda\kappa} \rightarrow \mathbb{R}^{n_\lambda}$ . A *combinatorial manifold*  $\widetilde{M}$  on  $M$  is such a topological space constituted by  $M_\lambda$ ,  $\lambda \in \Lambda$ . Clearly,  $\bigcup_{\lambda \in \Lambda} \Lambda_\lambda$  is countable. If  $n_\lambda = n$ , i.e., all  $M_\lambda$  is an  $n$ -manifold for  $\lambda \in \Lambda$ , then the union  $\mathcal{M}$  of  $M_\lambda$ ,  $\lambda \in \Lambda$  is also an  $n$ -manifold with alta

$$\widetilde{\mathcal{A}} = \bigcup_{\lambda \in \Lambda} \mathcal{A}_\lambda = \{(U_{\lambda\kappa}; \varphi_{\lambda\kappa}) \mid \kappa \in \Lambda_\lambda, \lambda \in \Lambda\}.$$

**Theorem 5.2** *A combinatorial manifold  $\widetilde{M}$  is a non-manifold on  $\mathcal{M}$ , i.e.,*

$$\widetilde{M} = \neg \mathcal{M}.$$

Accordingly, we only discuss non-manifolds  $\neg M$ . Define a topological graph  $G[\neg M]$  by

$$\begin{aligned} V(G[\neg M]) &= \{U_\lambda, \lambda \in \Lambda\}; \\ E(G[\neg M]) &= \{(U_{\lambda_1}, U_{\lambda_2}) \text{ if } U_{\lambda_1} \cap U_{\lambda_2} \neq \emptyset, \lambda_1, \lambda_2 \in \Lambda, \lambda_1 \neq \lambda_2\} \end{aligned}$$

with labels

$$\begin{aligned} L : U_\lambda \in V(G[\neg M]) &\rightarrow U_\lambda, \\ L : (U_{\lambda_1}, U_{\lambda_2}) \in E(\neg M) &\rightarrow U_{\lambda_1} \cap U_{\lambda_2}, \lambda_1 \neq \lambda_2 \in \Lambda, \end{aligned}$$

which is an invariant dependent only on *alta*  $\mathcal{A}$  of  $M$ .

Particularly, if each  $U_\lambda$  is a Euclidean spaces  $\mathbb{R}^\lambda$ ,  $\lambda \in \Lambda$ , we get another topological graph  $G[\mathbb{R}^\lambda, \lambda \in \Lambda]$  on Euclidean spaces  $\mathbb{R}^\lambda$ ,  $\lambda \in \Lambda$ , a special non-manifold called *combinatorial Euclidean space*. The following result on  $\neg M$  is easily obtained likewise the proof of Theorem 2.1 in [23].

**Theorem 5.3** *A non-manifold  $\neg M$  on manifold  $M$  with *alta**

$$\mathcal{A} = \{ (U_\lambda; \varphi_\lambda) \mid \lambda \in \Lambda \}$$

*inherits an topological invariant  $G[\neg M]$ . Furthermore, if  $M$  is locally compact,  $G[\neg M]$  is topological homeomorphic to  $G[\mathbb{R}^\lambda, \lambda \in \Lambda]$  if*

$$\varphi : U_\lambda \rightarrow \mathbb{R}^{n_\lambda}, \lambda \in \Lambda.$$

It should be noted that Whitney proved that an  $n$ -manifold can be topological embedded as a closed submanifold of  $\mathbb{R}^{2n+1}$  with a sharply minimum dimension  $2n + 1$  in 1936. Applying this result, one can easily show that a non-manifold  $\neg M$  can be embedded into  $\mathbb{R}^{2n_{\max}+1}$  if  $n_{\max} = \max\{n_\lambda \in \Lambda\} < \infty$ . Furthermore, let  $U_\lambda$  itself be a subset of Euclidean space  $\mathbb{R}^{n_{\max}+1}$  for  $\lambda \in \Lambda$ , then  $x_{n_{\max}+1} = \varphi_\lambda(x_1, x_2, \dots, x_{n_\lambda})$  in  $\mathbb{R}^{n_{\max}+1}$ . Thus, one gets an equation

$$x_{n_{\max}+1} - \varphi_\lambda(x_1, x_2, \dots, x_{n_\lambda}) = 0$$

in  $\mathbb{R}^{n_{\max}+1}$ . Particularly, if  $\Lambda = \{1, 2, \dots, m\}$  is finite, one gets a system  $(ES_m)$  of equations

$$\begin{cases} x_{n_{\max}+1} - \varphi_\lambda(x_1, x_2, \dots, x_{n_1}) = 0 \\ x_{n_{\max}+1} - \varphi_\lambda(x_1, x_2, \dots, x_{n_2}) = 0 \\ \dots\dots\dots \\ x_{n_{\max}+1} - \varphi_\lambda(x_1, x_2, \dots, x_{n_m}) = 0 \end{cases} \quad (ES_m)$$

in  $\mathbb{R}^{n_{\max}+1}$ . Generally, this system  $(ES_m)$  is non-solvable, which enables one getting Theorem 3.1 once again.

**5.3 Differentiable Non-Manifolds**

For  $\forall M_\lambda \in \neg M$ , if  $M_\lambda$  is differentiable determined by a system of differential equations

$$(DES_{m_\lambda}) \begin{cases} F_{\lambda 1}(x_1, x_2, \dots, x_n, u, u_{x_1}, \dots, u_{x_n}, u_{x_1 x_2}, \dots, u_{x_1 x_n}, \dots) = 0 \\ F_{\lambda 2}(x_1, x_2, \dots, x_n, u, u_{x_1}, \dots, u_{x_n}, u_{x_1 x_2}, \dots, u_{x_1 x_n}, \dots) = 0 \\ \dots \\ F_{\lambda m_\lambda}(x_1, x_2, \dots, x_n, u, u_{x_1}, \dots, u_{x_n}, u_{x_1 x_2}, \dots, u_{x_1 x_n}, \dots) = 0 \end{cases}$$

Then the system  $(DES_m)$  consisting of systems  $(DES_{m_\lambda})$ ,  $1 \leq \lambda \leq m$  of differential equations with prescribed initial values  $x_{i_0}, u_0, p_{i_0}$  for integers  $i = 1, 2, \dots, n$  is generally non-solvable with a geometrical figure of differentiable non-manifold  $\neg M$ .

Notice that a main characters for points  $p$  in non-manifold  $\neg M$  is that the number of variables for determining its position in space is not a constant. However, it can also introduces differentials on non-manifolds constrained with  $\varphi_\kappa|_{U_\kappa \cap U_\lambda} = \varphi_\lambda|_{U_\kappa \cap U_\lambda}$  for  $\forall (U_\kappa, \varphi_\kappa), (U_\lambda, \varphi_\lambda) \in \mathcal{A}$ , and smooth functions  $f : \neg M \rightarrow \mathbb{R}$  at a point  $p \in \neg M$ . Denoted respectively by  $\mathcal{X}_p, T_p \neg M$  all smooth functions and all tangent vectors  $\bar{v} : \mathcal{X}_p \rightarrow \mathbb{R}$  at a point  $p \in \neg M$ . If  $\varphi(p) \in \bigcap_{i=1}^s \mathbb{R}^{n_i(p)}$  and  $\widehat{s}(p) = \dim(\bigcap_{i=1}^s \mathbb{R}^{n_i(p)})$ , a simple calculation shows the dimension of tangent vector space

$$\dim T_p \neg M = \widehat{s}(p) + \sum_{i=1}^{s(p)} (n_i - \widehat{s}(p))$$

with a basis

$$\left\{ \left. \frac{\partial}{\partial x_{ij}} \right|_p, 1 \leq i \leq s(p), 1 \leq j \leq n_i \text{ with } x_{il} = x_{jl} \text{ if } 1 \leq l \leq \widehat{s}(p) \right\}$$

and similarly, for cotangent vector space  $\dim T_p^* \neg M = \dim T_p \neg M$  with a basis

$$\left\{ dx_{ij} \Big|_p, 1 \leq i \leq s(p), 1 \leq j \leq n_i \text{ with } x_{il} = x_{jl} \text{ if } 1 \leq l \leq \widehat{s}(p) \right\},$$

which enables one to introduce vector field  $\mathcal{X}(\neg M) = \bigcup_{p \in \neg M} \mathcal{X}_p$ , tensor field  $T_s^r(\neg M) = \bigcup_{p \in \neg M} T_s^r(p, \neg M)$ , where,

$$T_s^r(p, \neg M) = \underbrace{T_p \neg M \otimes \dots \otimes T_p \neg M}_r \otimes \underbrace{T_p^* \neg M \otimes \dots \otimes T_p^* \neg M}_s$$

and connection  $D : \mathcal{X}(\neg M) \times T_s^r(\neg M) \rightarrow T_s^r(\neg M)$  with  $D_X \tau = D(X, \tau)$  such that for  $\forall X, Y \in \mathcal{X}(\neg M), \tau, \pi \in T_s^r(\neg M), \lambda \in \mathbb{R}, f \in C^\infty(\neg M)$ ,

- (1)  $D_{X+fY} \tau = D_X \tau + f D_Y \tau$  and  $D_X(\tau + \lambda \pi) = D_X \tau + \lambda D_X \pi$ ;
- (2)  $D_X(\tau \otimes \pi) = D_X \tau \otimes \pi + \sigma \otimes D_X \pi$ ;

(3) For any contraction  $C$  on  $T_s^r(-M)$ ,  $D_X(C(\tau)) = C(D_X\tau)$ .

Particularly, let  $g \in T_2^0(-M)$ . If  $g$  is symmetrical and positive, then  $-M$  is called a *Riemannian non-manifold*, denoted by  $(-M, g)$ . It can be readily shown that there is a unique connection  $D$  on Riemannian non-manifold  $(-M, g)$  with equality

$$Z(g(X, Y)) = g(D_Z, Y) + g(X, D_Z Y)$$

holds. Such a  $D$  with  $(-M, g)$ , denoted by  $(-M, g, D)$  is called a *Riemannian non-geometry*.

Now let  $D \frac{\partial}{\partial x_{ij}} \frac{\partial}{\partial x_{kl}} = \Gamma_{(st)}^{(ij)(kl)} \frac{\partial}{\partial x_{ij}}$  on  $(U_p; \varphi)$  for point  $p \in (-M, g, D)$ . Then  $\Gamma_{(st)}^{(ij)(kl)} = \Gamma_{(st)}^{(kl)(ij)}$  and

$$\Gamma_{st}^{(kl)(ij)} = \frac{1}{2} g_{(st)(uv)} \left( \frac{\partial g^{(kl)(uv)}}{\partial x_{ij}} + \frac{\partial g^{(uv)(ij)}}{\partial x_{kl}} - \frac{\partial g^{(kl)(ij)}}{\partial x_{uv}} \right),$$

where  $g = g^{(kl)(ij)} dx_{kl} dx_{ij}$  and  $g_{(st)(uv)}$  is an element in matrix  $[g^{(kl)(ij)}]^{-1}$ .

Similarly, a *Riemannian curvature tensor*

$$R: \mathcal{X}(-M) \times \mathcal{X}(-M) \times \mathcal{X}(-M) \times \mathcal{X}(-M) \rightarrow C^\infty(-M)$$

of type (0, 4) is defined by  $R(X, Y, Z, W) = g(R(Z, W)X, Y)$  for  $\forall X, Y, Z, W \in \mathcal{X}(-M)$  and with a local form

$$R = R^{(ij)(kl)(st)(uv)} dx_{ij} \otimes dx_{kl} \otimes dx_{st} \otimes dx_{uv},$$

where

$$\begin{aligned} R^{(ij)(kl)(st)(uv)} &= \frac{1}{2} \left( \frac{\partial^2 g^{(st)(ij)}}{\partial x_{uv} \partial x_{kl}} + \frac{\partial^2 g^{(uv)(kl)}}{\partial x_{st} \partial x_{ij}} - \frac{\partial^2 g^{(st)(kl)}}{\partial x_{uv} \partial x_{ij}} - \frac{\partial^2 g^{(uv)(ij)}}{\partial x_{st} \partial x_{kl}} \right) \\ &\quad + \Gamma_{ab}^{(st)(ij)} \Gamma_{cd}^{(uv)(kl)} g^{(cd)(ab)} - \Gamma_{ab}^{(st)(kl)} \Gamma_{cd}^{(uv)(ij)} g^{(cd)(ab)}, \end{aligned}$$

for  $\forall p \in -M$  and  $g^{(ij)(kl)} = g\left(\frac{\partial}{\partial x_{ij}}, \frac{\partial}{\partial x_{kl}}\right)$ , which can be also used for measuring the curved degree of  $(-M, g, D)$  at point  $p \in -M$  (see [16] or [21] for details).

**Theorem 5.4** *A Riemannian non-geometry  $(-M, g, D)$  inherits an invariant, i.e., the curvature tensor  $R: \mathcal{X}(-M) \times \mathcal{X}(-M) \times \mathcal{X}(-M) \times \mathcal{X}(-M) \rightarrow C^\infty(-M)$ .*

## 5.4 Smarandache Geometry

A fundamental image of geometry  $\mathcal{G}$  is that of *space* consisting of point  $p$ , line  $L$ , plane  $P$ , etc. elements with inclusions  $P, L \ni p$  and  $P \supset L$  and a geometrical axiom is a premise logic function  $T$  on geometrical elements  $p, L, P, \dots \in \mathcal{G}$  with  $T(p, L, P, \dots) = 1$  in classical geometry. Contrast to the classic, a *Smarandache geometry*  $S\mathcal{G}$  is such a geometry with at least one axiom behaves in two different ways within the same space, i.e., validated and invalided, or only invalided but in multiple distinct ways. Thus,  $T(p, L, P, \dots) = 1$ ,  $\neg T(p, L, P, \dots) = 1$  hold simultaneously, or  $0 < \neg T(p, L, P, \dots) = I_1, I_2, \dots, I_k < 1$  for an integer  $k \geq 2$  in  $S\mathcal{G}$ ,

which enables one to discuss Smarandache geometry in two cases following:

**Case 1.**  $T(p, L, P, \dots) = 1 \wedge \neg T(p, L, P, \dots) = 1$  in  $S\mathcal{G}$ .

Denoted by  $U = T^{-1}(1) \subset S\mathcal{G}$ ,  $V = \neg T^{-1}(1) \subset S\mathcal{G}$ . Clearly, if  $U \cap V \neq \emptyset$  and there are  $p, L, P, \dots \in U \cap V$ . Then there must be  $T(p, L, P, \dots) = 1$  and  $\neg T(p, L, P, \dots) = 1$  in  $U \cap V$ , a contradiction. Thus,  $U \cap V = \emptyset$  or  $U \cap V \neq \emptyset$  but some of elements  $p, L, P, \dots \in S\mathcal{G}$  for  $T$  are missed in  $U \cap V$ .

Not loss of generality, let

$$U = \bigoplus_{k=1}^m U_C^k \quad \text{and} \quad V = \bigoplus_{i=1}^n V_C^i,$$

where  $U_C^k, V_C^i$  are respectively connected components in  $U$  and  $V$ . Define a topological graph  $G[U, V]$  following:

$$\begin{aligned} V(G[U, V]) &= \{U_C^k; 1 \leq k \leq m\} \cup \{V_C^i; 1 \leq i \leq n\}; \\ E(G[U, V]) &= \{(U_C^k, V_C^i) \text{ if } U_C^k \cap V_C^i \neq \emptyset, 1 \leq k \leq m, 1 \leq i \leq n\} \end{aligned}$$

with labels

$$\begin{aligned} L : U_C^k \in V(G[U, V]) &\rightarrow U_C^k, \quad V_C^i \in V(G[U, V]) \rightarrow V_C^i \\ L : (U_C^k, V_C^i) \in E(G[U, V]) &\rightarrow U_C^k \cap V_C^i, \quad 1 \leq k \leq m, 1 \leq i \leq n. \end{aligned}$$

Clearly, such a graph  $G[U, V]$  is bipartite, i.e.,  $G[U, V] \leq K_{m,n}$  with labels.

**Case 2.**  $0 < \neg T(p, L, P, \dots) = I_1, I_2, \dots, I_k < 1, k \geq 2$  in  $S\mathcal{G}$ .

Denoted by  $A_1 = \neg T^{-1}(I_1) \subset S\mathcal{G}$ ,  $A_2 = \neg T^{-1}(I_2) \subset S\mathcal{G}$ ,  $\dots$ ,  $A_k = \neg T^{-1}(I_k) \subset S\mathcal{G}$ . Similarly, if  $A_i \cap A_j \neq \emptyset$  and there are  $p, L, P, \dots \in A_i \cap A_j$ . Then there must be  $A_i \cap A_j = \emptyset$  or  $A_i \cap A_j \neq \emptyset$  but some of elements  $p, L, P, \dots \in S\mathcal{G}$  for  $T$  are missed in  $A_1 \cap A_j$  for integers  $1 \leq i \neq j \leq k$ .

Let  $A_i = \bigoplus_{l=1}^{m_i} A_C^{il}$  with  $A_C^{il}$ ,  $1 \leq l \leq m_i$  connected components in  $A_i$ . Define a topological graph  $G[A_i, [1, k]]$  following:

$$\begin{aligned} V(G[A_i, [1, k]]) &= \bigcup_{i=1}^k \{A_C^{il}; 1 \leq l \leq m_i\}; \\ E(G[A_i, [1, k]]) &= \bigcup_{\substack{i,j=1 \\ i \neq j}}^k \{(A_C^{il}, A_C^{js}) \text{ if } A_C^{il} \cap A_C^{js} \neq \emptyset, 1 \leq l \leq m_i, 1 \leq s \leq m_j\} \end{aligned}$$

with labels

$$\begin{aligned} L : A_C^{il} \in V(G[A_i, [1, k]]) &\rightarrow A_C^{il}, \quad A_C^{js} \in V(G[A_i, [1, k]]) \rightarrow A_C^{js} \\ L : (A_C^{il}, A_C^{js}) \in E(G[A_i, [1, k]]) &\rightarrow A_C^{il} \cap A_C^{js}, \quad 1 \leq l \leq m_i, 1 \leq s \leq m_j \end{aligned}$$

for integers  $1 \leq i \neq j \leq k$ . Clearly, such a graph  $G[A_i, [1, k]]$  is  $k$ -partite, i.e.,  $G[A_i, [1, k]] \leq K_{m_1, m_2, \dots, m_k}$  with labels.

For an invertible transformation  $T$  on geometry  $S\mathcal{G}$ , it is clear that  $T(p), T(L), T(P), \dots$  also constitute the elements of  $S\mathcal{G}$  with graphs  $G[U, V]$  and  $G[A_i, [1, k]]$  invariant. Thus, we know

**Theorem 5.5** *A Smarandache geometry  $S\mathcal{G}$  inherits a bipartite invariant  $G[U, V]$  or  $k$ -partite  $G[A_i, [1, k]]$  under the action of its linear invertible transformations.*

### 5.5 Geometrical Combinatorics

All previous discussions on non-space  $(\mathcal{X}^n, \mu)$ , non-manifold  $\neg M$  or differentiable non-manifold  $\neg M$  and Smarandache geometry  $S\mathcal{G}$  allude a philosophical notion that *any non-geometry can be decomposed into geometries inheriting an invariant  $G[\mathcal{X}^n, \mu], G[\neg M], G[U, V]$  or  $G[A_i, [1, k]]$  of topological graph labeled with those of geometries*, i.e., geometrical combinatorics accordant with that notion of Klein's. Accordingly, for extending field of geometry, one needs to determine the inherited invariants  $G[\mathcal{X}^n, \mu], G[\neg M], G[U, V]$  or  $G[A_i, [1, k]]$  and then know geometrical behaviors on non-geometries. But this approach is passive for including non-geometry to geometry. A more initiative way with realization is geometrical  $G$ -systems following:

**Definition 5.6** *Let  $(\mathcal{G}_1; \mathcal{A}_1), (\mathcal{G}_2; \mathcal{A}_2), \dots, (\mathcal{G}_m; \mathcal{A}_m)$  be  $m$  geometrical systems, where  $\mathcal{G}_i, \mathcal{A}_i$  be respectively the geometrical space and the system of axioms for an integer  $1 \leq i \leq m$ . A geometrical  $G$ -system is a topological graph  $G$  with labeling  $L : v \in V(G) \rightarrow L(v) \in \{\mathcal{G}_1, \mathcal{G}_2, \dots, \mathcal{G}_m\}$  and  $L : (u, v) \in E(G) \rightarrow L(u) \cap L(v)$  with  $L(u) \cap L(v) \neq \emptyset$ , denoted by  $G[\mathcal{G}, \mathcal{A}]$ , where  $\mathcal{G} = \bigcup_{i=1}^m \mathcal{G}_i$  and  $\mathcal{A} = \bigcup_{i=1}^m \mathcal{A}_i$ .*

Clearly, a geometrical  $G$ -system can be applied for holding on the global behavior of systems  $\mathcal{G}_1, \mathcal{G}_2, \dots, \mathcal{G}_m$ . For example, a geometrical  $K_4 - \{e\}$ -system is shown in Fig.11, where,  $\mathbb{R}^3_i, 1 \leq i \leq 4$  are Euclidean spaces with dimensional 3 and  $\mathbb{R}^3_i \cap \mathbb{R}^3_j$  maybe homeomorphic to  $\mathbb{R}, \mathbb{R}^2$  or  $\mathbb{R}^3$  for  $1 \leq i, j \leq 4$ .

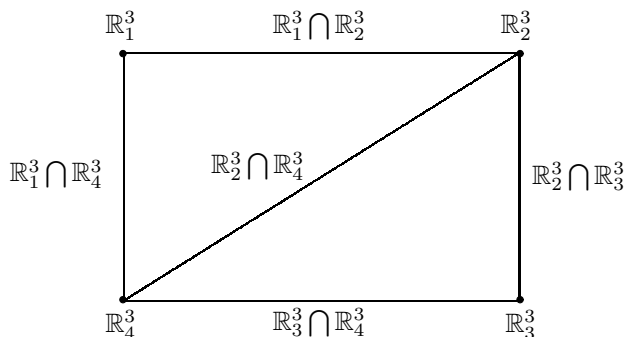

**Fig.11**

**Problem 5.7** *Characterize geometrical  $G$ -systems  $G[\mathcal{G}, \mathcal{A}]$ . Particularly, characterize these ge-*



ometrical  $G$ -systems, such as those of Euclidean geometry, Riemannian geometry, Lobachevshy-Bolyai-Gauss geometry for complete graphs  $G = K_m$ , complete  $k$ -partite graph  $K_{m_1, m_2, \dots, m_k}$ , path  $P_m$  or circuit  $C_m$ .

**Problem 5.8** Characterize geometrical  $G$ -systems  $G[\mathcal{G}, \mathcal{A}]$  for topological or differentiable manifold, particularly, Euclidean space, projective space for complete graphs  $G = K_m$ , complete  $k$ -partite graph  $K_{m_1, m_2, \dots, m_k}$ , path  $P_m$  or circuit  $C_m$ .

It should be noted that classic geometrical system are mostly  $K_1$ -systems, such as those of Euclidean geometry, projective geometry,  $\dots$ , etc., also a few  $K_2$ -systems. For example, the topological group and Lie group are in fact geometrical  $K_2$ -systems, but neither  $K_m$ -system with  $m \geq 3$ , nor  $G \not\cong K_m$ -system.

## §6. Applications

As we known, mathematical non-systems are generally faced up human beings in scientific fields. Even through, the mathematical combinatorics contributes an approach for holding on their global behaviors.

### 6.1 Economics

A *circulating economic system* is such a overall balance input-output  $M(t) = \bigcup_{i=1}^m M_i(t)$  underlying a topological graph  $G[M(t)]$  that there are no rubbish in each producing department. Whence, there is a circuit-decomposition  $G[M(t)] = \bigcup_{s=1}^l \vec{C}_s$  such that each output of a producing department  $M_i(t)$ ,  $1 \leq i \leq m$  is on a directed circuit  $\vec{C}_s$  for an integer  $1 \leq s \leq l$ , such as those shown in Fig.12.

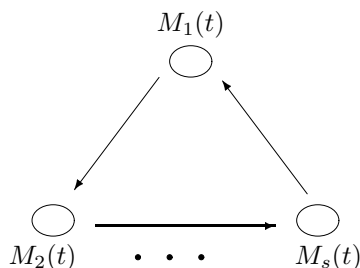

Fig.12

Assume that there are  $m$  producing departments  $M_1(t), M_2(t), \dots, M_m(t)$ ,  $x_{ij}$  output values of  $M_i(t)$  for the department  $M_j(t)$  and  $d_i$  for the social demand. Let  $F_i(x_{1i}, x_{2i}, \dots, x_{ni})$  be the producing function in  $M_i(t)$ . Then the input-output model of a circulating economic

system can be characterized by a system of equations

$$\begin{cases} F_1(\bar{x}) = \sum_{j=1}^m x_{1j} + d_1 \\ F_2(\bar{x}) = \sum_{j=1}^m x_{2j} + d_2 \\ \dots\dots\dots \\ F_m(\bar{x}) = \sum_{j=1}^m x_{mj} + d_m \end{cases}$$

Generally, this system is non-solvable even if it is a linear system. Nevertheless, it is a  $G$ -system of equations. The main task is not finding its solutions, but determining whether it runs smoothly, i.e., a macro-economic behavior of system.

### 6.2 Epidemiology

Assume that there are three kind groups in persons at time  $t$ , i.e., infected  $I(t)$ , susceptible  $S(t)$  and recovered  $R(t)$  with  $S(t) + I(t) + R(t) = 1$ . Then one established the *SIR model* of infectious disease as follows:

$$\begin{cases} \frac{dS}{dt} = -kIS, \\ \frac{dI}{dt} = kIS - hI, \\ S(0) = S_0, I(0) = I_0, R(0) = 0, \end{cases},$$

which are non-linear equations of first order.

If the number of persons in an area is not constant, let  $C_1, C_2, \dots, C_m$  be  $m$  segregation areas with respective  $N_1, N_2, \dots, N_m$  persons. Assume at time  $t$ , there are  $U_i(t), V_i(t)$  persons moving in or away  $C_i$ . Thus  $S_i(t) + I_i(t) - U_i(t) + V_i(t) = N_i$ . Denoted by  $c_{ij}(t)$  the persons moving from  $C_i$  to  $C_j$  for integers  $1 \leq i, j \leq m$ . Then

$$\sum_{s=1}^m c_{si}(t) = U_i(t) \quad \text{and} \quad \sum_{s=1}^m c_{is}(t) = V_i(t).$$

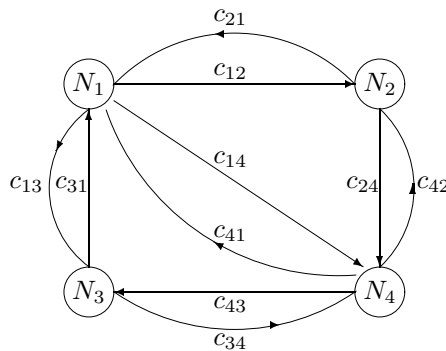

Fig.13

A combinatorial model of infectious disease is defined by a topological graph  $G$  following:

$$\begin{aligned} V(G) &= \{C_1, C_2, \dots, C_m\}, \\ E(G) &= \{(C_i, C_j) \mid \text{there are traffic means from } C_i \text{ to } C_j, 1 \leq i, j \leq m\}, \\ L(C_i) &= N_i, \quad L^+(C_i, C_j) = c_{ij} \text{ for } \forall (C_i, C_j) \in E(G^l), 1 \leq i, j \leq m, \end{aligned}$$

such as those shown in Fig.13.

In this case, the SIR model for areas  $C_i, 1 \leq i \leq m$  turns to

$$\left. \begin{aligned} \frac{dS_i}{dt} &= -kI_iS_i, \\ \frac{dI_i}{dt} &= kI_iS_i - hI_i, \\ S_i(0) &= S_{i0}, I_i(0) = I_{i0}, R(0) = 0, \end{aligned} \right\} 1 \leq i \leq m,$$

which is a non-solvable system of differential equations.

Even if the number of an area is constant, the SIR model works only with the assumption that a healed person acquired immunity and will never be infected again. If it does not hold, the SIR model will not immediately work, such as those of cases following:

**Case 1.** there are  $m$  known virus  $\mathcal{V}_1, \mathcal{V}_2, \dots, \mathcal{V}_m$  with infected rate  $k_i$ , heal rate  $h_i$  for integers  $1 \leq i \leq m$  and an person infected a virus  $\mathcal{V}_i$  will never infects other viruses  $\mathcal{V}_j$  for  $j \neq i$ .

**Case 2.** there are  $m$  varying  $\mathcal{V}_1, \mathcal{V}_2, \dots, \mathcal{V}_m$  from a virus  $\mathcal{V}$  with infected rate  $k_i$ , heal rate  $h_i$  for integers  $1 \leq i \leq m$  such as those shown in Fig.14.

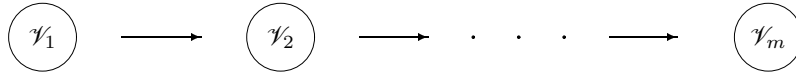

Fig.14

However, it is easily to establish a non-solvable differential model for the spread of viruses following by combining SIR model:

$$\left\{ \begin{aligned} \dot{S} &= -k_1SI \\ \dot{I} &= k_1SI - h_1I \\ \dot{R} &= h_1I \end{aligned} \right. \quad \left\{ \begin{aligned} \dot{S} &= -k_2SI \\ \dot{I} &= k_2SI - h_2I \\ \dot{R} &= h_2I \end{aligned} \right. \quad \dots \quad \left\{ \begin{aligned} \dot{S} &= -k_mSI \\ \dot{I} &= k_mSI - h_mI \\ \dot{R} &= h_mI \end{aligned} \right.$$

Consider the equilibrium points of this system enables one to get a conclusion ([27]) for globally control of infectious diseases, i.e., they decline to 0 finally if

$$0 < S < \sum_{i=1}^m h_i / \sum_{i=1}^m k_i,$$

particularly, these infectious viruses are globally controlled if each of them is controlled in that area.

### 6.3 Gravitational Field

What is the true face of gravitation? Einstein's equivalence principle says that *there are no difference for physical effects of the inertial force and the gravitation in a field small enough*, i.e., considering the curvature at each point in a spacetime to be all effect of gravitation, called *geometrization of gravitation*, which finally resulted in Einstein's gravitational equations ([2])

$$R^{\mu\nu} - \frac{1}{2}Rg^{\mu\nu} + \lambda g^{\mu\nu} = -8\pi GT^{\mu\nu}$$

in  $\mathbb{R}^4$ , where  $R^{\mu\nu} = R_{\alpha}^{\mu\alpha\nu} = g_{\alpha\beta}R^{\alpha\mu\beta\nu}$ ,  $R = g_{\mu\nu}R^{\mu\nu}$  are the respective Ricci tensor, Ricci scalar curvature,  $G = 6.673 \times 10^{-8}cm^3/gs^2$ ,  $\kappa = 8\pi G/c^4 = 2.08 \times 10^{-48}cm^{-1} \cdot g^{-1} \cdot s^2$  and Schwarzschild spacetime with a spherically symmetric Riemannian metric

$$ds^2 = f(t) \left(1 - \frac{r_g}{r}\right) dt^2 - \frac{1}{1 - \frac{r_g}{r}} dr^2 - r^2(d\theta^2 + \sin^2\theta d\phi^2)$$

for  $\lambda = 0$ . However, a most puzzled question faced up human beings is *whether the dimension of the universe is really 3? if not, what is the meaning of one's observations?* Certainly, if the dimension  $\geq 4$ , all these observations are nothing else but a projection of the true faces on our six organs, a pseudo-truth.

For a gravitational field  $\mathbb{R}^n$  with  $n \geq 4$ , decompose it into dimensional 3 Euclidean spaces  $\mathbb{R}_u^3, \mathbb{R}_v^3, \dots, \mathbb{R}_w^3$ . Then there are Einstein's gravitational equations:

$$\begin{aligned} R^{\mu_u\nu_u} - \frac{1}{2}g^{\mu_u\nu_u} R &= -8\pi GT^{\mu_u\nu_u}, \\ R^{\mu_v\nu_v} - \frac{1}{2}g^{\mu_v\nu_v} R &= -8\pi GT^{\mu_v\nu_v}, \\ &\dots\dots\dots, \\ R^{\mu_w\nu_w} - \frac{1}{2}g^{\mu_w\nu_w} R &= -8\pi GT^{\mu_w\nu_w} \end{aligned}$$

for each  $\mathbb{R}_u^3, \mathbb{R}_v^3, \dots, \mathbb{R}_w^3$ , such as a  $K_4$ -system shown in Fig.15,

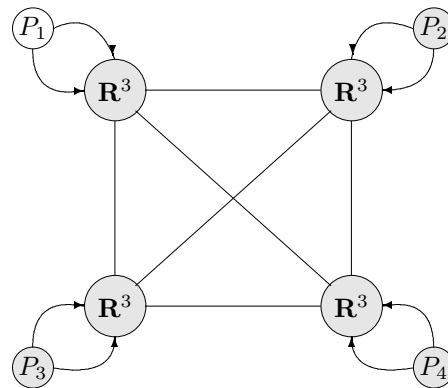

Fig.15

where  $P_1, P_2, P_3, P_4$  are the observations. In this case, these gravitational equations can be represented by

$$R^{(\mu\nu)(\sigma\tau)} - \frac{1}{2}g^{(\mu\nu)(\sigma\tau)}R = -8\pi GT^{(\mu\nu)(\sigma\tau)}$$

with a coordinate matrix

$$[\bar{x}_p] = \begin{bmatrix} x_{11} & \cdots & x_{1\hat{m}} & \cdots & x_{13} \\ x_{21} & \cdots & x_{2\hat{m}} & \cdots & x_{23} \\ \cdots & \cdots & \cdots & \cdots & \cdots \\ x_{m1} & \cdots & x_{m\hat{m}} & \cdots & x_{m3} \end{bmatrix}$$

for  $\forall p \in \mathbb{R}^n$ , where  $\hat{m} = \dim\left(\bigcap_{i=1}^m \mathbf{R}^{n_i}\right)$  a constant for  $\forall p \in \bigcap_{i=1}^m \mathbf{R}^{n_i}$  and  $x^{il} = \frac{x^l}{m}$  for  $1 \leq i \leq m, 1 \leq l \leq \hat{m}$ . Then, by the *Projective Principle*, i.e., a *physics law in a Euclidean space*  $\mathbb{R}^n \simeq \tilde{\mathbb{R}} = \bigcup_{i=1}^n \mathbb{R}^3$  with  $n \geq 4$  is invariant under a projection on  $\mathbb{R}^3$  from  $\mathbb{R}^n$ , one can determines its combinatorial Schwarzschild metric. For example, if  $\hat{m} = 4$ , i.e.,  $t_\mu = t, r_\mu = r, \theta_\mu = \theta$  and  $\phi_\mu = \phi$  for  $1 \leq \mu \leq m$ , then ([18])

$$ds^2 = \sum_{\mu=1}^m \left(1 - \frac{2Gm_\mu}{c^2 r}\right) dt^2 - \sum_{\mu=1}^m \left(1 - \frac{2Gm_\mu}{c^2 r}\right)^{-1} dr^2 - mr^2(d\theta^2 + \sin^2 \theta d\phi^2)$$

and furthermore, if  $m_\mu = M$  for  $1 \leq \mu \leq m$ , then

$$ds^2 = \left(1 - \frac{2GM}{c^2 r}\right) m dt^2 - \left(1 - \frac{2GM}{c^2 r}\right)^{-1} m dr^2 - mr^2(d\theta^2 + \sin^2 \theta d\phi^2),$$

which is the most enjoyed case by human beings. If so, all the behavior of universe can be realized finally by human beings. But if  $\hat{m} \leq 3$ , there are infinite underlying connected graphs, one can only find an approximating theory for the universe, i.e., “Name named is not the eternal Name”, claimed by Lao Zi.

## References

- [1] G.Birkhoff and S.MacLane, *A Survey of Modern Algebra* (4th edition), Macmillan Publishing Co., Inc, 1977.
- [2] M.Carmeli, *Classical Fields–General Relativity and Gauge Theory*, World Scientific, 2001.
- [3] Fritz John. *Partial Differential Equations*(4th Edition). New York, USA: Springer-Verlag, 1982.
- [4] J.L.Gross and T.W.Tucker, *Topological Graph Theory*, John Wiley & Sons, 1987.
- [5] G.B.Gurevich, *Foundations of the Theory of Algebraic Invariants*, P.Noordhoff Ltd. Groningen, the Netherlands, 1964.
- [6] David Hilbert, *Theory of Algebraic Invariants*, Cambridge University Press, 1993.
- [7] H.Iseri, *Smarandache Manifolds*, American Research Press, Rehoboth, NM,2002.

- [8] John M.Lee, *Introduction to Topological Manifolds*, Springer-Verlag New York, Inc., 2000.
- [9] J.C.Lu, *Fangfo Analyzing LAO ZHI - Explaining TAO TEH KING by TAI JI* (in Chinese), Tuan Jie Publisher, Beijing, 2004.
- [10] F.Klein, A comparative review of recent researches in geometry, *Bull. New York Math. Soc.*, 2(1892-1893), 215-249.
- [11] Linfan Mao, On algebraic multi-group spaces, *Scientia Magna*, Vol.2, No.1 (2006), 64-70.
- [12] Linfan Mao, On multi-metric spaces, *Scientia Magna*, Vol.2, No.1(2006), 87-94.
- [13] Linfan Mao, On algebraic multi-vector spaces, *Scientia Magna*, Vol.2, No.2 (2006), 1-6.
- [14] Linfan Mao, On algebraic multi-ring spaces, *Scientia Magna*, Vol.2, No.2(2006), 48-54.
- [15] Linfan Mao, Combinatorial speculation and combinatorial conjecture for mathematics, *International J.Math. Combin.* Vol.1(2007), No.1, 1-19.
- [16] Linfan Mao, Geometrical theory on combinatorial manifolds, *JP J.Geometry and Topology*, Vol.7, No.1(2007),65-114.
- [17] Linfan Mao, Combinatorial fields-an introduction, *International J. Math. Combin.*, Vol.1(2009), Vol.3, 1-22.
- [18] Linfan Mao, Relativity in combinatorial gravitational fields, *Progress in Physics*, Vol.3(2010), 39-50.
- [19] Linfan Mao, *Automorphism Groups of Maps, Surfaces and Smarandache Geometries*, First edition published by American Research Press in 2005, Second edition is as a Graduate Textbook in Mathematics, Published by The Education Publisher Inc., USA, 2011.
- [20] Linfan Mao, *Smarandache Multi-Space Theory*(Second edition), First edition published by Hexis, Phoenix in 2006, Second edition is as a Graduate Textbook in Mathematics, Published by The Education Publisher Inc., USA, 2011.
- [21] Linfan Mao, *Combinatorial Geometry with Applications to Field Theory*, First edition published by InfoQuest in 2005, Second edition is as a Graduate Textbook in Mathematics, Published by The Education Publisher Inc., USA, 2011.
- [22] Linfan Mao, Non-solvable spaces of linear equation systems. *International J. Math. Combin.*, Vol.2 (2012), 9-23.
- [23] Linfan Mao, Graph structure of manifolds listing, *International J.Contemp. Math. Sciences*, Vol.5, 2011, No.2,71-85.
- [24] Linfan Mao, A generalization of Seifert-Van Kampen theorem for fundamental groups, *Far East Journal of Math.Sciences*, Vol.61 No.2 (2012), 141-160.
- [25] Linfan Mao, Global stability of non-solvable ordinary differential equations with applications, *International J.Math. Combin.*, Vol.1 (2013), 1-37.
- [26] Linfan Mao, Non-solvable equation systems with graphs embedded in  $\mathbf{R}^n$ , *International J.Math. Combin.*, Vol.2 (2013), 8-23.
- [27] Linfan Mao, Non-solvable partial differential equations of first order with applications, submitted.
- [28] F.Smarandache, *Paradoxist Geometry*, State Archives from Valcea, Rm. Valcea, Romania, 1969, and in *Paradoxist Mathematics*, Collected Papers (Vol. II), Kishinev University Press, Kishinev, 5-28, 1997.

- [29] F.Smarandache, Multi-space and multi-structure, in *Neutrosophy. Neutrosophic Logic, Set, Probability and Statistics*, American Research Press, 1998.
- [30] F.Smarandache, *A Unifying Field in Logics. Neutrosopy: Neturosophic Probability, Set, and Logic*, American research Press, Rehoboth, 1999.
- [31] W.B.V.Kandasamy, *Bialgebraic Structures and Smarandache Bialgebraic Structures*, American Research Press, 2003.
- [32] Wolfgang Walter, *Ordinary Differential Equations*, Springer-Verlag New York, Inc., 1998.

## Non-Solvable Spaces of Linear Equation Systems

**Abstract:** A *Smarandache system*  $(\Sigma; \mathcal{R})$  is such a mathematical system that has at least one *Smarandachely denied rule* in  $\mathcal{R}$ , i.e., there is a rule in  $(\Sigma; \mathcal{R})$  that behaves in at least two different ways within the same set  $\Sigma$ , i.e., validated and invalidated, or only invalidated but in multiple distinct ways. For such systems, the linear equation systems without solutions, i.e., non-solvable linear equation systems are the most simple one. We characterize such non-solvable linear equation systems with their homeomorphisms, particularly, the non-solvable linear equation systems with 2 or 3 variables by combinatorics. It is very interesting that every planar graph with each edge a straight segment is homologous to such a non-solvable linear equation with 2 variables.

**Key Words:** Smarandachely denied axiom, Smarandache system, non-solvable linear equations,  $\vee$ -solution,  $\wedge$ -solution.

**AMS(2010):** 15A06, 68R10

### §1. Introduction

Finding the exact solution of equation system is a main but a difficult objective unless the case of linear equations in classical mathematics. Contrary to this fact, *what is about the non-solvable case?* In fact, such an equation system is nothing but a contradictory system, and characterized only by non-solvable equations for conclusion. But our world is overlap and hybrid. The number of non-solvable equations is more than that of the solvable. The main purpose of this paper is to characterize the behavior of such linear equation systems.

Let  $\mathbb{R}^n, \mathbb{R}^m$  be Euclidean spaces with dimensional  $n, m \geq 1$  and  $T : \mathbb{R}^n \times \mathbb{R}^m \rightarrow \mathbb{R}^m$  be a  $\mathbb{C}^k, 1 \leq k \leq \infty$  function such that  $T(\bar{x}_0, \bar{y}_0) = \bar{0}$  for  $\bar{x}_0 \in \mathbb{R}^n, \bar{y}_0 \in \mathbb{R}^m$  and the  $m \times m$  matrix  $\partial T^j / \partial y^i(\bar{x}_0, \bar{y}_0)$  is non-singular, i.e.,

$$\det\left(\frac{\partial T^j}{\partial y^i}\right)\Big|_{(\bar{x}_0, \bar{y}_0)} \neq 0, \text{ where } 1 \leq i, j \leq m.$$

Then the implicit function theorem ([1]) implies that there exist opened neighborhoods  $V \subset \mathbb{R}^n$  of  $\bar{x}_0, W \subset \mathbb{R}^m$  of  $\bar{y}_0$  and a  $\mathbb{C}^k$  function  $\phi : V \rightarrow W$  such that

$$T(\bar{x}, \phi(\bar{x})) = \bar{0}.$$

Thus there always exists solutions for the equation  $T(\bar{x}, \overline{\phi(\bar{x})}) = \bar{0}$  if  $T$  is  $\mathbb{C}^k, 1 \leq k \leq \infty$ . Now let  $T_1, T_2, \dots, T_m, m \geq 1$  be different  $\mathbb{C}^k$  functions  $\mathbb{R}^n \times \mathbb{R}^m \rightarrow \mathbb{R}^m$  for an integer  $k \geq 1$ . An

---

<sup>1</sup>*International J. Math. Combin.* Vol.2(2012), 9-23.



equation system discussed in this paper is with the form following

$$T_i(\bar{x}, \bar{y}) = \bar{0}, \quad 1 \leq i \leq m. \tag{Eq}$$

A point  $(\bar{x}_0, \bar{y}_0)$  is a  $\vee$ -solution of the equation system (Eq) if

$$T_i(\bar{x}_0, \bar{y}_0) = \bar{0}$$

for some integers  $i$ ,  $1 \leq i \leq m$ , and a  $\wedge$ -solution of (Eq) if

$$T_i(\bar{x}_0, \bar{y}_0) = \bar{0}$$

for all integers  $1 \leq i_0 \leq m$ . Denoted by  $S_i^0$  the solutions of equation  $T_i(\bar{x}, \bar{y}) = \bar{0}$  for integers  $1 \leq i \leq m$ . Then  $\bigcup_{i=1}^m S_i^0$  and  $\bigcap_{i=1}^m S_i^0$  are respectively the  $\vee$ -solutions and  $\wedge$ -solutions of equations (Eq). By definition, we are easily knowing that the  $\wedge$ -solution is nothing but the same as the classical solution.

**Definition 1.1** *The  $\vee$ -solvable,  $\wedge$ -solvable and non-solvable spaces of equations (Eq) are respectively defined by*

$$\bigcup_{i=1}^m S_i^0, \quad \bigcap_{i=1}^m S_i^0 \quad \text{and} \quad \bigcup_{i=1}^m S_i^0 - \bigcap_{i=1}^m S_i^0.$$

Now we construct a finite graph  $G[Eq]$  of equations (Eq) following:

$$V(G[Eq]) = \{v_i | 1 \leq i \leq m\},$$

$$E(G[Eq]) = \{(v_i, v_j) | \exists (\bar{x}_0, \bar{y}_0) \Rightarrow T_i(\bar{x}_0, \bar{y}_0) = \bar{0} \wedge T_j(\bar{x}_0, \bar{y}_0) = \bar{0}, \quad 1 \leq i, j \leq m\}.$$

Such a graph  $G[Eq]$  can be also represented by a vertex-edge labeled graph  $G^L[Eq]$  following:

$$V(G^L[Eq]) = \{S_i^0 | 1 \leq i \leq m\},$$

$$E(G[Eq]) = \{(S_i^0, S_j^0) \text{ labeled with } S_i^0 \cap S_j^0 | S_i^0 \cap S_j^0 \neq \emptyset, \quad 1 \leq i, j \leq m\}.$$

For example, let  $S_1^0 = \{a, b, c\}$ ,  $S_2^0 = \{c, d, e\}$ ,  $S_3^0 = \{a, c, e\}$  and  $S_4^0 = \{d, e, f\}$ . Then its edge-labeled graph  $G[Eq]$  is shown in Fig.1 following.

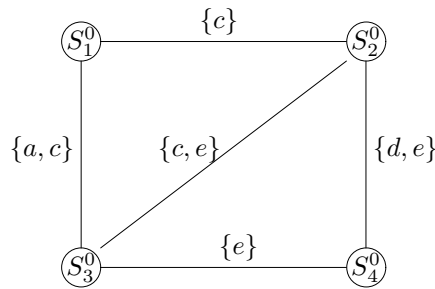

**Fig.1**

Notice that  $\bigcup_{i=1}^m S_i^0 = \bigcup_{i=1}^m S_i^0$ , i.e., the non-solvable space is empty only if  $m = 1$  in (Eq). Generally, let  $(\Sigma_1; \mathcal{R}_1), (\Sigma_2; \mathcal{R}_2), \dots, (\Sigma_m; \mathcal{R}_m)$  be mathematical systems, where  $\mathcal{R}_i$  is a rule on  $\Sigma_i$  for integers  $1 \leq i \leq m$ . If for two integers  $i, j, 1 \leq i, j \leq m, \Sigma_i \neq \Sigma_j$  or  $\Sigma_i = \Sigma_j$  but  $\mathcal{R}_i \neq \mathcal{R}_j$ , then they are said to be *different*, otherwise, *identical*.

**Definition 1.2**([12]-[13]) *A rule in  $\mathcal{R}$  a mathematical system  $(\Sigma; \mathcal{R})$  is said to be Smarandachely denied if it behaves in at least two different ways within the same set  $\Sigma$ , i.e., validated and invalidated, or only invalidated but in multiple distinct ways.*

*A Smarandache system  $(\Sigma; \mathcal{R})$  is a mathematical system which has at least one Smarandachely denied rule in  $\mathcal{R}$ .*

Thus, such a Smarandache system is a contradictory system. Generally, we know the conception of Smarandache multi-space with its underlying combinatorial structure defined following.

**Definition 1.3**([8]-[10]) *Let  $(\Sigma_1; \mathcal{R}_1), (\Sigma_2; \mathcal{R}_2), \dots, (\Sigma_m; \mathcal{R}_m)$  be  $m \geq 2$  mathematical spaces, different two by two. A Smarandache multispace  $\tilde{\Sigma}$  is a union  $\bigcup_{i=1}^m \Sigma_i$  with rules  $\tilde{\mathcal{R}} = \bigcup_{i=1}^m \mathcal{R}_i$  on  $\tilde{\Sigma}$ , i.e., the rule  $\mathcal{R}_i$  on  $\Sigma_i$  for integers  $1 \leq i \leq m$ , denoted by  $(\tilde{\Sigma}; \tilde{\mathcal{R}})$ .*

Similarly, the underlying graph of a Smarandache multispace  $(\tilde{\Sigma}; \tilde{\mathcal{R}})$  is an edge-labeled graph defined following.

**Definition 1.4**([8]-[10]) *Let  $(\tilde{\Sigma}; \tilde{\mathcal{R}})$  be a Smarandache multispace with  $\tilde{\Sigma} = \bigcup_{i=1}^m \Sigma_i$  and  $\tilde{\mathcal{R}} = \bigcup_{i=1}^m \mathcal{R}_i$ . Its underlying graph  $G[\tilde{\Sigma}, \tilde{\mathcal{R}}]$  is defined by*

$$V(G[\tilde{\Sigma}, \tilde{\mathcal{R}}]) = \{\Sigma_1, \Sigma_2, \dots, \Sigma_m\},$$

$$E(G[\tilde{\Sigma}, \tilde{\mathcal{R}}]) = \{(\Sigma_i, \Sigma_j) \mid \Sigma_i \cap \Sigma_j \neq \emptyset, 1 \leq i, j \leq m\}$$

*with an edge labeling*

$$l^E : (\Sigma_i, \Sigma_j) \in E(G[\tilde{\Sigma}, \tilde{\mathcal{R}}]) \rightarrow l^E(\Sigma_i, \Sigma_j) = \varpi(\Sigma_i \cap \Sigma_j),$$

*where  $\varpi$  is a characteristic on  $\Sigma_i \cap \Sigma_j$  such that  $\Sigma_i \cap \Sigma_j$  is isomorphic to  $\Sigma_k \cap \Sigma_l$  if and only if  $\varpi(\Sigma_i \cap \Sigma_j) = \varpi(\Sigma_k \cap \Sigma_l)$  for integers  $1 \leq i, j, k, l \leq m$ .*

We consider the simplest case, i.e., all equations in (Eq) are linear with integers  $m \geq n$  and  $m, n \geq 1$  in this paper because we are easily know the necessary and sufficient condition of a linear equation system is solvable or not in linear algebra. For terminologies and notations not mentioned here, we follow [2]-[3] for linear algebra, [8] and [10] for graphs and topology.

Let

$$AX = (b_1, b_2, \dots, b_m)^T \tag{LEq}$$

be a linear equation system with

$$A = \begin{bmatrix} a_{11} & a_{12} & \cdots & a_{1n} \\ a_{21} & a_{22} & \cdots & a_{2n} \\ \cdots & \cdots & \cdots & \cdots \\ a_{m1} & a_{m2} & \cdots & a_{mn} \end{bmatrix} \quad \text{and} \quad X = \begin{bmatrix} x_1 \\ x_2 \\ \cdots \\ x_n \end{bmatrix}$$

for integers  $m, n \geq 1$ . Define an augmented matrix  $A^+$  of  $A$  by  $(b_1, b_2, \dots, b_m)^T$  following:

$$A^+ = \begin{bmatrix} a_{11} & a_{12} & \cdots & a_{1n} & b_1 \\ a_{21} & a_{22} & \cdots & a_{2n} & b_2 \\ \cdots & \cdots & \cdots & \cdots & \cdots \\ a_{m1} & a_{m2} & \cdots & a_{mn} & b_m \end{bmatrix}$$

We assume that all equations in  $(LEq)$  are non-trivial, i.e., there are no numbers  $\lambda$  such that

$$(a_{i1}, a_{i2}, \dots, a_{in}, b_i) = \lambda(a_{j1}, a_{j2}, \dots, a_{jn}, b_j)$$

for any integers  $1 \leq i, j \leq m$ . Such a linear equation system  $(LEq)$  is *non-solvable* if there are no solutions  $x_i, 1 \leq i \leq n$  satisfying  $(LEq)$ .

## §2. A Necessary and Sufficient Condition for Non-Solvable Linear Equations

The following result on non-solvable linear equations is well-known in linear algebra([2]-[3]).

**Theorem 2.1** *The linear equation system  $(LEq)$  is solvable if and only if  $\text{rank}(A) = \text{rank}(A^+)$ . Thus, the equation system  $(LEq)$  is non-solvable if and only if  $\text{rank}(A) \neq \text{rank}(A^+)$ .*

We introduce the conception of parallel linear equations following.

**Definition 2.2** *For any integers  $1 \leq i, j \leq m, i \neq j$ , the linear equations*

$$\begin{aligned} a_{i1}x_1 + a_{i2}x_2 + \cdots + a_{in}x_n &= b_i, \\ a_{j1}x_1 + a_{j2}x_2 + \cdots + a_{jn}x_n &= b_j \end{aligned}$$

*are called parallel if there exists a constant  $c$  such that*

$$c = a_{j1}/a_{i1} = a_{j2}/a_{i2} = \cdots = a_{jn}/a_{in} \neq b_j/b_i.$$

Then we know the following conclusion by Theorem 2.1.

**Corollary 2.3** For any integers  $i, j$ ,  $i \neq j$ , the linear equation system

$$\begin{cases} a_{i1}x_1 + a_{i2}x_2 + \cdots + a_{in}x_n = b_i, \\ a_{j1}x_1 + a_{j2}x_2 + \cdots + a_{jn}x_n = b_j \end{cases}$$

is non-solvable if and only if they are parallel.

*Proof* By Theorem 2.1, we know that the linear equations

$$\begin{aligned} a_{i1}x_1 + a_{i2}x_2 + \cdots + a_{in}x_n &= b_i, \\ a_{j1}x_1 + a_{j2}x_2 + \cdots + a_{jn}x_n &= b_j \end{aligned}$$

is non-solvable if and only if  $\text{rank}A' \neq \text{rank}B'$ , where

$$A' = \begin{bmatrix} a_{i1} & a_{i2} & \cdots & a_{in} \\ a_{j1} & a_{j2} & \cdots & a_{jn} \end{bmatrix}, \quad B' = \begin{bmatrix} a_{i1} & a_{i2} & \cdots & a_{in} & b_1 \\ a_{j1} & a_{j2} & \cdots & a_{jn} & b_2 \end{bmatrix}.$$

It is clear that  $1 \leq \text{rank}A' \leq \text{rank}B' \leq 2$  by the definition of matrixes  $A'$  and  $B'$ . Consequently,  $\text{rank}A' = 1$  and  $\text{rank}B' = 2$ . Thus the matrix  $A'$ ,  $B'$  are respectively elementary equivalent to matrixes

$$\begin{bmatrix} 1 & 0 & \cdots & 0 \\ 0 & 0 & \cdots & 0 \end{bmatrix}, \quad \begin{bmatrix} 1 & 0 & \cdots & 0 & 0 \\ 0 & 1 & \cdots & 0 & 0 \end{bmatrix}.$$

i.e., there exists a constant  $c$  such that  $c = a_{j1}/a_{i1} = a_{j2}/a_{i2} = \cdots = a_{jn}/a_{in}$  but  $c \neq b_j/b_i$ . Whence, the linear equations

$$\begin{aligned} a_{i1}x_1 + a_{i2}x_2 + \cdots + a_{in}x_n &= b_i, \\ a_{j1}x_1 + a_{j2}x_2 + \cdots + a_{jn}x_n &= b_j \end{aligned}$$

is parallel by definition. □

We are easily getting another necessary and sufficient condition for non-solvable linear equations ( $LEq$ ) by three elementary transformations on a  $m \times (n + 1)$  matrix  $A^+$  defined following:

- (1) Multiplying one row of  $A^+$  by a non-zero scalar  $c$ ;
- (2) Replacing the  $i$ th row of  $A^+$  by row  $i$  plus a non-zero scalar  $c$  times row  $j$ ;
- (3) Interchange of two row of  $A^+$ .

Such a transformation naturally induces a transformation of linear equation system ( $LEq$ ), denoted by  $T(LEq)$ . By applying Theorem 2.1, we get a generalization of Corollary 2.3 for non-solvable linear equation system ( $LEq$ ) following.



linear equation system ( $LEq$ ) is solvable. Contradicts to the assumption.  $\square$

This result naturally determines the combinatorial structure underlying a linear equation system following.

**Theorem 2.5** *A linear equation system ( $LEq$ ) is non-solvable if and only if there exists a composition  $T$  of series elementary transformations such that*

$$G[T(LEq)] \not\cong K_m,$$

where  $K_m$  is a complete graph of order  $m$ .

*Proof* Let  $T(A^+)$  be

$$T(A^+) = \begin{bmatrix} a'_{11} & a'_{12} & \cdots & a'_{1n} & b'_1 \\ a'_{21} & a'_{22} & \cdots & a'_{2n} & b'_2 \\ \cdots & \cdots & \cdots & \cdots & \cdots \\ a'_{m1} & a'_{m2} & \cdots & a'_{mn} & b'_m \end{bmatrix}.$$

If there are integers  $1 \leq i, j \leq m$  such that the linear equations

$$\begin{aligned} a'_{i1}x_1 + a'_{i2}x_2 + \cdots + a'_{in}x_n &= b'_i, \\ a'_{j1}x_1 + a'_{j2}x_2 + \cdots + a'_{jn}x_n &= b'_j \end{aligned}$$

are parallel, then there must be  $S_i^0 \cap S_j^0 = \emptyset$ , where  $S_i^0, S_j^0$  are respectively the solutions of linear equations  $a'_{i1}x_1 + a'_{i2}x_2 + \cdots + a'_{in}x_n = b'_i$  and  $a'_{j1}x_1 + a'_{j2}x_2 + \cdots + a'_{jn}x_n = b'_j$ . Whence, there are no edges  $(S_i^0, S_j^0)$  in  $G[LEq]$  by definition. Thus  $G[LEq] \not\cong K_m$ .  $\square$

We wish to find conditions for non-solvable linear equation systems ( $LEq$ ) without elementary transformations. In fact, we are easily determining  $G[LEq]$  of a linear equation system ( $LEq$ ) by Corollary 2.3. Let  $L_i$  be the  $i$ th linear equation. By Corollary 2.3, we divide these equations  $L_i, 1 \leq i \leq m$  into *parallel families*

$$\mathcal{C}_1, \mathcal{C}_2, \dots, \mathcal{C}_s$$

by the property that all equations in a family  $\mathcal{C}_i$  are parallel and there are no other equations parallel to lines in  $\mathcal{C}_i$  for integers  $1 \leq i \leq s$ . Denoted by  $|\mathcal{C}_i| = n_i, 1 \leq i \leq s$ . Then the following conclusion is clear by definition.

**Theorem 2.6** *Let ( $LEq$ ) be a linear equation system for integers  $m, n \geq 1$ . Then*

$$G[LEq] \simeq K_{n_1, n_2, \dots, n_s}$$

with  $n_1 + n_2 + \cdots + n_s = m$ , where  $\mathcal{C}_i$  is the parallel family with  $n_i = |\mathcal{C}_i|$  for integers  $1 \leq i \leq s$  in ( $LEq$ ) and ( $LEq$ ) is non-solvable if  $s \geq 2$ .

*Proof* Notice that equations in a family  $\mathcal{C}_i$  is parallel for an integer  $1 \leq i \leq m$  and each of them is not parallel with all equations in  $\bigcup_{1 \leq l \leq m, l \neq i} \mathcal{C}_l$ . Let  $n_i = |\mathcal{C}_i|$  for integers  $1 \leq i \leq s$  in  $(LEq)$ . By definition, we know

$$G[LEq] \simeq K_{n_1, n_2, \dots, n_s}$$

with  $n_1 + n_2 + \dots + n_s = m$ .

Notice that the linear equation system  $(LEq)$  is solvable only if  $G[LEq] \simeq K_m$  by definition. Thus the linear equation system  $(LEq)$  is non-solvable if  $s \geq 2$ .  $\square$

Notice that the conditions in Theorem 2.6 is not sufficient, i.e., if  $G[LEq] \simeq K_{n_1, n_2, \dots, n_s}$ , we can not claim that  $(LEq)$  is non-solvable or not. For example, let  $(LEq^*)$  and  $(LEq^{**})$  be two linear equations systems with

$$A_1^+ = \begin{bmatrix} 1 & 0 & 0 \\ 0 & 1 & 0 \\ 1 & 1 & 0 \\ 1 & -1 & 0 \end{bmatrix} \quad A_2^+ = \begin{bmatrix} 1 & 0 & 0 \\ 0 & 1 & 0 \\ 1 & 2 & 2 \\ -1 & 2 & 2 \end{bmatrix} .$$

Then  $G[LEq^*] \simeq G[LEq^{**}] \simeq K_4$ . Clearly, the linear equation system  $(LEq^*)$  is solvable with  $x_1 = 0, x_2 = 0$  but  $(LEq^{**})$  is non-solvable. We will find necessary and sufficient conditions for linear equation systems with two or three variables just by their combinatorial structures in the following sections.

### §3. Linear Equation System with 2 Variables

Let

$$AX = (b_1, b_2, \dots, b_m)^T \tag{LEq2}$$

be a linear equation system in 2 variables with

$$A = \begin{bmatrix} a_{11} & a_{12} \\ a_{21} & a_{22} \\ \dots & \dots \\ a_{m1} & a_{m2} \end{bmatrix} \quad \text{and} \quad X = \begin{bmatrix} x_1 \\ x_2 \end{bmatrix}$$

for an integer  $m \geq 2$ . Then Theorem 2.4 is refined in the following.

**Theorem 3.1** *A linear equation system  $(LEq2)$  is non-solvable if and only if one of the following conditions hold:*

- (1) *there are integers  $1 \leq i, j \leq m$  such that  $a_{i1}/a_{j1} = a_{i2}/a_{j2} \neq b_i/b_j$ ;*

(2) there are integers  $1 \leq i, j, k \leq m$  such that

$$\frac{\begin{vmatrix} a_{i1} & a_{i2} \\ a_{j1} & a_{j2} \end{vmatrix}}{\begin{vmatrix} a_{i1} & a_{i2} \\ a_{k1} & a_{k2} \end{vmatrix}} \neq \frac{\begin{vmatrix} a_{i1} & b_i \\ a_{j1} & b_j \end{vmatrix}}{\begin{vmatrix} a_{i1} & b_i \\ a_{k1} & b_k \end{vmatrix}}.$$

*Proof* The condition (1) is nothing but the conclusion in Corollary 2.3, i.e., the  $i$ th equation is parallel to the  $j$ th equation. Now if there no such parallel equations in (LEq2), let  $T$  be the elementary transformation replacing all other  $j$ th equations by the  $j$ th equation plus  $(-a_{j1}/a_{i1})$  times the  $i$ th equation for integers  $1 \leq j \leq m$ . We get a transformation  $T(A^+)$  of  $A^+$  following

$$T(A^+) = \begin{bmatrix} 0 & \begin{vmatrix} a_{i1} & a_{i2} \\ a_{11} & a_{12} \end{vmatrix} & \begin{vmatrix} a_{i1} & b_i \\ a_{11} & b_1 \end{vmatrix} \\ \dots & \dots & \dots \\ 0 & \begin{vmatrix} a_{i1} & a_{i2} \\ a_{s1} & a_{s2} \end{vmatrix} & \begin{vmatrix} a_{i1} & b_i \\ a_{s1} & b_s \end{vmatrix} \\ a_{i1} & a_{i2} & b_i \\ 0 & \begin{vmatrix} a_{i1} & a_{i2} \\ a_{t1} & a_{t2} \end{vmatrix} & \begin{vmatrix} a_{i1} & b_i \\ a_{t1} & b_t \end{vmatrix} \\ \dots & \dots & \dots \\ 0 & \begin{vmatrix} a_{i1} & a_{i2} \\ a_{m1} & a_{m2} \end{vmatrix} & \begin{vmatrix} a_{i1} & b_i \\ a_{m1} & b_m \end{vmatrix} \end{bmatrix},$$

where  $s = i - 1$ ,  $t = i + 1$ . Applying Corollary 2.3 again, we know that there are integers  $1 \leq i, j, k \leq m$  such that

$$\frac{\begin{vmatrix} a_{i1} & a_{i2} \\ a_{j1} & a_{j2} \end{vmatrix}}{\begin{vmatrix} a_{i1} & a_{i2} \\ a_{k1} & a_{k2} \end{vmatrix}} \neq \frac{\begin{vmatrix} a_{i1} & b_i \\ a_{j1} & b_j \end{vmatrix}}{\begin{vmatrix} a_{i1} & b_i \\ a_{k1} & b_k \end{vmatrix}}.$$

if the linear equation system (LEQ2) is non-solvable.  $\square$

Notice that a linear equation  $ax_1 + bx_2 = c$  with  $a \neq 0$  or  $b \neq 0$  is a straight line on  $\mathbb{R}^2$ . We get the following result.

**Theorem 3.2** A linear equation system (LEq2) is non-solvable if and only if one of conditions following hold:

(1) there are integers  $1 \leq i, j \leq m$  such that  $a_{i1}/a_{j1} = a_{i2}/a_{j2} \neq b_i/b_j$ ;



$$(2) \text{ let } \begin{vmatrix} a_{11} & a_{12} \\ a_{21} & a_{22} \end{vmatrix} \neq 0 \text{ and}$$

$$x_1^0 = \frac{\begin{vmatrix} b_1 & a_{21} \\ b_2 & a_{22} \end{vmatrix}}{\begin{vmatrix} a_{11} & a_{12} \\ a_{21} & a_{22} \end{vmatrix}}, \quad x_2^0 = \frac{\begin{vmatrix} a_{11} & b_1 \\ a_{21} & b_2 \end{vmatrix}}{\begin{vmatrix} a_{11} & a_{12} \\ a_{21} & a_{22} \end{vmatrix}}.$$

Then there is an integer  $i$ ,  $1 \leq i \leq m$  such that

$$a_{i1}(x_1 - x_1^0) + a_{i2}(x_2 - x_2^0) \neq 0.$$

*Proof* If the linear equation system (*LEq2*) has a solution  $(x_1^0, x_2^0)$ , then

$$x_1^0 = \frac{\begin{vmatrix} b_1 & a_{21} \\ b_2 & a_{22} \end{vmatrix}}{\begin{vmatrix} a_{11} & a_{12} \\ a_{21} & a_{22} \end{vmatrix}}, \quad x_2^0 = \frac{\begin{vmatrix} a_{11} & b_1 \\ a_{21} & b_2 \end{vmatrix}}{\begin{vmatrix} a_{11} & a_{12} \\ a_{21} & a_{22} \end{vmatrix}}$$

and  $a_{i1}x_1^0 + a_{i2}x_2^0 = b_i$ , i.e.,  $a_{i1}(x_1 - x_1^0) + a_{i2}(x_2 - x_2^0) = 0$  for any integers  $1 \leq i \leq m$ . Thus, if the linear equation system (*LEq2*) is non-solvable, there must be integers  $1 \leq i, j \leq m$  such that  $a_{i1}/a_{j1} = a_{i2}/a_{j2} \neq b_i/b_j$ , or there is an integer  $1 \leq i \leq m$  such that

$$a_{i1}(x_1 - x_1^0) + a_{i2}(x_2 - x_2^0) \neq 0.$$

This completes the proof.  $\square$

For a non-solvable linear equation system (*LEq2*), there is a naturally induced *intersection-free graph*  $I[LEq2]$  by (*LEq2*) on the plane  $\mathbb{R}^2$  defined following:

$$V(I[LEq2]) = \{(x_1^{ij}, x_2^{ij}) | a_{i1}x_1^{ij} + a_{i2}x_2^{ij} = b_i, a_{j1}x_1^{ij} + a_{j2}x_2^{ij} = b_j, 1 \leq i, j \leq m\}.$$

$E(I[LEq2]) = \{(v_{ij}, v_{il}) | \text{the segment between points } (x_1^{ij}, x_2^{ij}) \text{ and } (x_1^{il}, x_2^{il}) \text{ in } \mathbb{R}^2\}$ . (where  $v_{ij} = (x_1^{ij}, x_2^{ij})$  for  $1 \leq i, j \leq m$ ).

Such an intersection-free graph is clearly a planar graph with each edge a straight segment since all intersection of edges appear at vertices. For example, let the linear equation system be (*LEq2*) with

$$A^+ = \begin{bmatrix} 1 & 1 & 2 \\ 1 & 1 & 3 \\ 1 & 2 & 3 \\ 1 & 2 & 4 \end{bmatrix}.$$

Then its intersection-free graph  $I[LEq2]$  is shown in Fig.2.

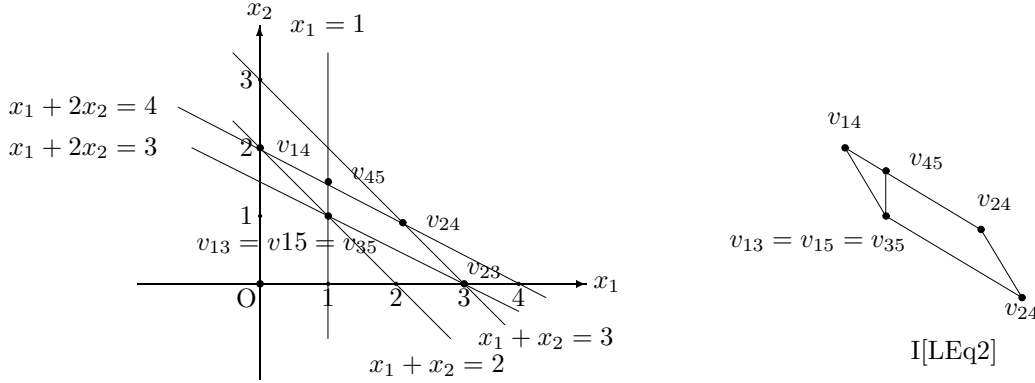

Fig.2

Let  $H$  be a planar graph with each edge a straight segment on  $\mathbb{R}^2$ . Its  $c$ -line graph  $L_C(H)$  is defined by

$$V(L_C(H)) = \{\text{straight lines } L = e_1 e_2 \cdots e_l, l \geq 1 \text{ in } H\};$$

$$E(L_C(H)) = \{(L_1, L_2) \mid \text{if } e_i^1 \text{ and } e_j^2 \text{ are adjacent in } H \text{ for } L_1 = e_1^1 e_2^1 \cdots e_l^1, L_2 = e_1^2 e_2^2 \cdots e_s^2, l, s \geq 1\}.$$

The following result characterizes the combinatorial structure of non-solvable linear equation systems with two variables by intersection-free graphs  $I[LEq2]$ .

**Theorem 3.3** *A linear equation system (LEq2) is non-solvable if and only if*

$$G[LEq2] \simeq L_C(H),$$

where  $H$  is a planar graph of order  $|H| \geq 2$  on  $\mathbb{R}^2$  with each edge a straight segment

*Proof* Notice that there is naturally a one to one mapping  $\phi : V(G[LEq2]) \rightarrow V(L_C(I[LEq2]))$  determined by  $\phi(S_i^0) = S_i^1$  for integers  $1 \leq i \leq m$ , where  $S_i^0$  and  $S_i^1$  denote respectively the solutions of equation  $a_{i1}x_1 + a_{i2}x_2 = b_i$  on the plane  $\mathbb{R}^2$  or the union of points between  $(x_1^{ij}, x_2^{ij})$  and  $(x_1^{il}, x_2^{il})$  with

$$\begin{cases} a_{i1}x_1^{ij} + a_{i2}x_2^{ij} = b_i \\ a_{j1}x_1^{ij} + a_{j2}x_2^{ij} = b_j \end{cases}$$

and

$$\begin{cases} a_{i1}x_1^{il} + a_{i2}x_2^{il} = b_i \\ a_{l1}x_1^{il} + a_{l2}x_2^{il} = b_l \end{cases}$$

for integers  $1 \leq i, j, l \leq m$ . Now if  $(S_i^0, S_j^0) \in E(G[LEq2])$ , then  $S_i^0 \cap S_j^0 \neq \emptyset$ . Whence,

$$S_i^1 \cap S_j^1 = \phi(S_i^0) \cap \phi(S_j^0) = \phi(S_i^0 \cap S_j^0) \neq \emptyset$$

by definition. Thus  $(S_i^1, S_j^1) \in L_C(I[LEq2])$ . By definition,  $\phi$  is an isomorphism between  $G[LEq2]$  and  $L_C(I[LEq2])$ , a line graph of planar graph  $I[LEq2]$  with each edge a straight segment.

Conversely, let  $H$  be a planar graph with each edge a straight segment on the plane  $\mathbb{R}^2$ . Not loss of generality, we assume that edges  $e_{1,2}, \dots, e_l \in E(H)$  is on a straight line  $L$  with equation  $a_{L1}x_1 + a_{L2}x_2 = b_L$ . Denote all straight lines in  $H$  by  $\mathcal{C}$ . Then  $H$  is the intersection-free graph of linear equation system

$$a_{L1}x_1 + a_{L2}x_2 = b_L, \quad L \in \mathcal{C}. \quad (LEq2^*)$$

Thus,

$$G[LEq2^*] \simeq H.$$

This completes the proof.  $\square$

Similarly, we can also consider the liner equation system  $(LEq2)$  with condition on  $x_1$  or  $x_2$  such as

$$AX = (b_1, b_2, \dots, b_m)^T \quad (L^-Eq2)$$

with

$$A = \begin{bmatrix} a_{11} & a_{12} \\ a_{21} & a_{22} \\ \dots & \dots \\ a_{m1} & a_{m2} \end{bmatrix}, \quad X = \begin{bmatrix} x_1 \\ x_2 \end{bmatrix}$$

and  $x_1 \geq x^0$  for a real number  $x^0$  and an integer  $m \geq 2$ . In geometry, each of there equation is a ray on the plane  $\mathbb{R}^2$ , seeing also references [5]-[6]. Then the following conclusion can be obtained like with Theorems 3.2 and 3.3.

**Theorem 3.4** *A linear equation system  $(L^-Eq2)$  is non-solvable if and only if*

$$G[LEq2] \simeq L_C(H),$$

where  $H$  is a planar graph of order  $|H| \geq 2$  on  $\mathbb{R}^2$  with each edge a straight segment.

#### §4. Linear Equation Systems with 3 Variables

Let

$$AX = (b_1, b_2, \dots, b_m)^T \quad (LEq3)$$

be a linear equation system in 3 variables with

$$A = \begin{bmatrix} a_{11} & a_{12} & a_{13} \\ a_{21} & a_{22} & a_{23} \\ \cdots & \cdots & \cdots \\ a_{m1} & a_{m2} & a_{m3} \end{bmatrix} \quad \text{and} \quad X = \begin{bmatrix} x_1 \\ x_2 \\ x_3 \end{bmatrix}$$

for an integer  $m \geq 3$ . Then Theorem 2.4 is refined in the following.

**Theorem 4.1** *A linear equation system (LEq3) is non-solvable if and only if one of the following conditions hold:*

- (1) *there are integers  $1 \leq i, j \leq m$  such that  $a_{i1}/a_{j1} = a_{i2}/a_{j2} = a_{i3}/a_{j3} \neq b_i/b_j$ ;*
- (2) *if  $(a_{i1}, a_{i2}, a_{i3})$  and  $(a_{j1}, a_{j2}, a_{j3})$  are independent, then there are numbers  $\lambda, \mu$  and an integer  $l$ ,  $1 \leq l \leq m$  such that*

$$(a_{l1}, a_{l2}, a_{l3}) = \lambda(a_{i1}, a_{i2}, a_{i3}) + \mu(a_{j1}, a_{j2}, a_{j3})$$

*but  $b_l \neq \lambda b_i + \mu b_j$ ;*

- (3) *if  $(a_{i1}, a_{i2}, a_{i3})$ ,  $(a_{j1}, a_{j2}, a_{j3})$  and  $(a_{k1}, a_{k2}, a_{k3})$  are independent, then there are numbers  $\lambda, \mu, \nu$  and an integer  $l$ ,  $1 \leq l \leq m$  such that*

$$(a_{l1}, a_{l2}, a_{l3}) = \lambda(a_{i1}, a_{i2}, a_{i3}) + \mu(a_{j1}, a_{j2}, a_{j3}) + \nu(a_{k1}, a_{k2}, a_{k3})$$

*but  $b_l \neq \lambda b_i + \mu b_j + \nu b_k$ .*

*Proof* By Theorem 2.1, the linear equation system (LEq3) is non-solvable if and only if  $1 \leq \text{rank}A \neq \text{rank}A^+ \leq 4$ . Thus the non-solvable possibilities of (LEq3) are respectively  $\text{rank}A = 1$ ,  $2 \leq \text{rank}A^+ \leq 4$ ,  $\text{rank}A = 2$ ,  $3 \leq \text{rank}A^+ \leq 4$  and  $\text{rank}A = 3$ ,  $\text{rank}A^+ = 4$ . We discuss each of these cases following.

**Case 1**  $\text{rank}A = 1$  but  $2 \leq \text{rank}A^+ \leq 4$

In this case, all row vectors in  $A$  are dependent. Thus there exists a number  $\lambda$  such that  $\lambda = a_{i1}/a_{j1} = a_{i2}/a_{j2} = a_{i3}/a_{j3}$  but  $\lambda \neq b_i/b_j$ .

**Case 2**  $\text{rank}A = 2$ ,  $3 \leq \text{rank}A^+ \leq 4$

In this case, there are two independent row vectors. Without loss of generality, let  $(a_{i1}, a_{i2}, a_{i3})$  and  $(a_{j1}, a_{j2}, a_{j3})$  be such row vectors. Then there must be an integer  $l$ ,  $1 \leq l \leq m$  such that the  $l$ th row can not be the linear combination of the  $i$ th row and  $j$ th row. Whence, there are numbers  $\lambda, \mu$  such that

$$(a_{l1}, a_{l2}, a_{l3}) = \lambda(a_{i1}, a_{i2}, a_{i3}) + \mu(a_{j1}, a_{j2}, a_{j3})$$

but  $b_l \neq \lambda b_i + \mu b_j$ .

**Case 3**  $\text{rank}A = 3$ ,  $\text{rank}A^+ = 4$

In this case, there are three independent row vectors. Without loss of generality, let  $(a_{i1}, a_{i2}, a_{i3})$ ,  $(a_{j1}, a_{j2}, a_{j3})$  and  $(a_{k1}, a_{k2}, a_{k3})$  be such row vectors. Then there must be an integer  $l$ ,  $1 \leq l \leq m$  such that the  $l$ th row can not be the linear combination of the  $i$ th row,  $j$ th row and  $k$ th row. Thus there are numbers  $\lambda, \mu, \nu$  such that

$$(a_{l1}, a_{l2}, a_{l3}) = \lambda(a_{i1}, a_{i2}, a_{i3}) + \mu(a_{j1}, a_{j2}, a_{j3}) + \nu(a_{k1}, a_{k2}, a_{k3})$$

but  $b_l \neq \lambda b_i + \mu b_j + \nu b_k$ . Combining the discussion of Case 1-Case 3, the proof is complete.  $\square$

Notice that the linear equation system  $(LEq3)$  can be transformed to the following  $(LEq3^*)$  by elementary transformation, i.e., each  $j$ th row plus  $-a_{j3}/a_{i3}$  times the  $i$ th row in  $(LEq3)$  for an integer  $i$ ,  $1 \leq i \leq m$  with  $a_{i3} \neq 0$ ,

$$A'X = (b'_1, b'_2, \dots, b'_m)^T \quad (LEq3^*)$$

with

$$A'^+ = \begin{bmatrix} a'_{11} & a'_{12} & 0 & b'_1 \\ \dots & \dots & \dots & \dots \\ a'_{(i-1)1} & a'_{(i-1)2} & 0 & b'_{i-1} \\ a_{i1} & a_{i2} & a_{i3} & b_i \\ a'_{(i+1)1} & a'_{(i+1)2} & 0 & b'_{i+1} \\ a'_{m1} & a'_{m2} & 0 & b'_m \end{bmatrix},$$

where  $a'_{j1} = a_{j1} - a_{j3}a_{i1}/a_{i3}$ ,  $a'_{j2} = a_{j2} - a_{j3}a_{i2}/a_{i3}$  and  $b'_j = b_j - a_{j3}b_i/a_{i3}$  for integers  $1 \leq j \leq m$ . Applying Theorem 3.3, we get the a combinatorial characterizing on non-solvable linear systems  $(LEq3)$  following.

**Theorem 4.2** *A linear equation system  $(LEq3)$  is non-solvable if and only if  $G[LEq3] \not\cong K_m$  or  $G[LEq3^*] \simeq u + L_C(H)$ , where  $H$  denotes a planar graph with order  $|H| \geq 2$ , size  $m - 1$  and each edge a straight segment,  $u + G$  the join of vertex  $u$  with  $G$ .*

*Proof* By Theorem 2.4, the linear equation system  $(LEq3)$  is non-solvable if and only if  $G[LEq3] \not\cong K_m$  or the linear equation system  $(LEq3^*)$  is non-solvable, which implies that the linear equation subsystem following

$$BX' = (b'_1, \dots, b'_{i-1}, b'_{i+1}, \dots, b'_m)^T \quad (LEq2^*)$$

with

$$B = \begin{bmatrix} a'_{11} & a'_{12} \\ \dots & \dots \\ a'_{(i-1)1} & a'_{(i-1)2} \\ a'_{(i+1)1} & a'_{(i+1)2} \\ a'_{m1} & a'_{m2} \end{bmatrix} \quad \text{and} \quad X' = (x_1, x_2)^T$$

is non-solvable. Applying Theorem 3.3, we know that the linear equation subsystem  $(LEq2^*)$  is non-solvable if and only if  $G[LEq2^*] \simeq L_C(H)$ , where  $H$  is a planar graph  $H$  of size  $m - 1$  with each edge a straight segment. Thus the linear equation system  $(LEq3^*)$  is non-solvable if and only if  $G[LEq3^*] \simeq u + L_C(H)$ .  $\square$

### §5. Linear Homeomorphisms Equations

A homeomorphism on  $\mathbb{R}^n$  is a continuous 1 – 1 mapping  $h : \mathbb{R}^n \rightarrow \mathbb{R}^n$  such that its inverse  $h^{-1}$  is also continuous for an integer  $n \geq 1$ . There are indeed many such homeomorphisms on  $\mathbb{R}^n$ . For example, the linear transformations  $T$  on  $\mathbb{R}^n$ . A *linear homeomorphisms equation system* is such an equation system

$$AX = (b_1, b_2, \dots, b_m)^T \quad (L^hEq)$$

with  $X = (h(x_1), h(x_2), \dots, h(x_n))^T$ , where  $h$  is a homeomorphism and

$$A = \begin{bmatrix} a_{11} & a_{12} & \cdots & a_{1n} \\ a_{21} & a_{22} & \cdots & a_{2n} \\ \cdots & \cdots & \cdots & \cdots \\ a_{m1} & a_{m2} & \cdots & a_{mn} \end{bmatrix}$$

for integers  $m, n \geq 1$ . Notice that the linear homeomorphism equation system

$$\begin{cases} a_{i1}h(x_1) + a_{i2}h(x_2) + \cdots + a_{in}h(x_n) = b_i, \\ a_{j1}h(x_1) + a_{j2}h(x_2) + \cdots + a_{jn}h(x_n) = b_j \end{cases}$$

is solvable if and only if the linear equation system

$$\begin{cases} a_{i1}x_1 + a_{i2}x_2 + \cdots + a_{in}x_n = b_i, \\ a_{j1}x_1 + a_{j2}x_2 + \cdots + a_{jn}x_n = b_j \end{cases}$$

is solvable. Similarly, two linear homeomorphism equations are said *parallel* if they are non-solvable. Applying Theorems 2.6, 3.3, 4.2, we know the following result for linear homeomorphism equation systems  $(L^hEq)$ .

**Theorem 5.1** *Let  $(L^hEq)$  be a linear homeomorphism equation system for integers  $m, n \geq 1$ . Then*

- (1)  $G[LEq] \simeq K_{n_1, n_2, \dots, n_s}$  with  $n_1 + n_2 + \cdots + n_s = m$ , where  $\mathcal{C}_i^h$  is the parallel family with  $n_i = |\mathcal{C}_i^h|$  for integers  $1 \leq i \leq s$  in  $(L^hEq)$  and  $(L^hEq)$  is non-solvable if  $s \geq 2$ ;
- (2) If  $n = 2$ ,  $(L^hEq)$  is non-solvable if and only if  $G[L^hEq] \simeq L_C(H)$ , where  $H$  is a planar graph of order  $|H| \geq 2$  on  $\mathbb{R}^2$  with each edge a homeomorphism of straight segment, and if  $n = 3$ ,  $(L^hEq)$  is non-solvable if and only if  $G[L^hEq] \not\cong K_m$  or  $G[LEq3^*] \simeq u + L_C(H)$ ,

where  $H$  denotes a planar graph with order  $|H| \geq 2$ , size  $m-1$  and each edge a homeomorphism of straight segment.

## References

- [1] R.Abraham, J.E.Marsden and T.Ratiu, *Manifolds, Tensors Analysis and Applications*, Addison-Wesley Publishing Company, Inc., 1983.
- [2] G.Birkhoff and S.MacLane, *A Survey of Modern Algebra* (4th edition), Macmillan Publishing Co., Inc, 1977.
- [3] K.Hoffman and R.Kunze, *Linear Algebra* (2th edition), Prentice-Hall, Inc., Englewood Cliffs, New Jersey, 1971.
- [4] L.Kuciuk and M.Antholy, An Introduction to Smarandache Geometries, *JP Journal of Geometry and Topology*, 5(1), 2005,77-81.
- [5] Linfan Mao, Parallel bundles in planar map geometries, *Scientia Magna*, Vol.1(2005), No.2, 120-133.
- [6] Linfan Mao, On multi-metric spaces, *Scientia Magna*, Vol.2,No.1(2006), 87-94.
- [7] Linfan Mao, Euclidean pseudo-geometry on  $\mathbf{R}^n$ , *International J.Math. Combin.*, Vol.1 (2009), 90-95.
- [8] Linfan Mao, *Automorphism Groups of Maps, Surfaces and Smarandache Geometries* (Second edition), Graduate Textbook in Mathematics, The Education Publisher Inc. 2011.
- [9] Linfan Mao, *Smarandache Multi-Space Theory* (Second edition), Graduate Textbook in Mathematics, The Education Publisher Inc. 2011.
- [10] Linfan Mao, *Combinatorial Geometry with Applications to Field Theory* (Second edition), Graduate Textbook in Mathematics, The Education Publisher Inc. 2011.
- [11] W.S.Massey, *Algebraic Topology: An Introduction*, Springer-Verlag, New York, etc., 1977.
- [12] F.Smarandache, Mixed noneuclidean geometries, *Eprint arXiv: math/0010119*, 10/2000.
- [13] F.Smarandache, *A Unifying Field in Logics-Neutrosopy: Neturosophic Probability, Set, and Logic*, American research Press, Rehoboth, 1999.

## Global Stability of Non-Solvable Ordinary Differential Equations With Applications

**Abstract:** Different from the system in classical mathematics, a Smarandache system is a contradictory system in which an axiom behaves in at least two different ways within the same system, i.e., validated and invalidated, or only invalidated but in multiple distinct ways. Such systems exist extensively in the world, particularly, in our daily life. In this paper, we discuss such a kind of Smarandache system, i.e., non-solvable ordinary differential equation systems by a combinatorial approach, classify these systems and characterize their behaviors, particularly, the global stability, such as those of sum-stability and prod-stability of such linear and non-linear differential equations. Some applications of such systems to other sciences, such as those of globally controlling of infectious diseases, establishing dynamical equations of instable structure, particularly, the  $n$ -body problem and understanding global stability of matters with multilateral properties can be also found.

**Key Words:** Global stability, non-solvable ordinary differential equation, general solution, G-solution, sum-stability, prod-stability, asymptotic behavior, Smarandache system, inherit graph, instable structure, dynamical equation, multilateral matter.

**AMS(2010):** 05C15, 34A30, 34A34, 37C75, 70F10, 92B05

### §1. Introduction

Finding the exact solution of an equation system is a main but a difficult objective unless some special cases in classical mathematics. Contrary to this fact, *what is about the non-solvable case for an equation system?* In fact, such an equation system is nothing but a contradictory system, and characterized only by having no solution as a conclusion. But our world is overlap and hybrid. The number of non-solvable equations is much more than that of the solvable and such equation systems can be also applied for characterizing the behavior of things, which reflect the real appearances of things by that their complexity in our world. It should be noted that such non-solvable linear algebraic equation systems have been characterized recently by the author in the reference [7]. The main purpose of this paper is to characterize the behavior of such non-solvable ordinary differential equation systems.

Assume  $m, n \geq 1$  to be integers in this paper. Let

$$\dot{X} = F(X) \tag{DES^1}$$

---

<sup>1</sup>*International J. Math. Combin.* Vol.1(2013), 01-37.



be an autonomous differential equation with  $F : \mathbf{R}^n \rightarrow \mathbf{R}^n$  and  $F(\bar{0}) = 0$ , particularly, let

$$\dot{X} = AX \quad (LDES^1)$$

be a linear differential equation system and

$$x^{(n)} + a_1x^{(n-1)} + \cdots + a_nx = 0 \quad (LDE^n)$$

a linear differential equation of order  $n$  with

$$A = \begin{bmatrix} a_{11} & a_{12} & \cdots & a_{1n} \\ a_{21} & a_{22} & \cdots & a_{2n} \\ \cdots & \cdots & \cdots & \cdots \\ a_{n1} & a_{n2} & \cdots & a_{nn} \end{bmatrix} \quad X = \begin{bmatrix} x_1(t) \\ x_2(t) \\ \cdots \\ x_n(t) \end{bmatrix} \quad \text{and} \quad F(t, X) = \begin{bmatrix} f_1(t, X) \\ f_2(t, X) \\ \cdots \\ f_n(t, X) \end{bmatrix},$$

where all  $a_i, a_{ij}, 1 \leq i, j \leq n$  are real numbers with

$$\dot{X} = (\dot{x}_1, \dot{x}_2, \cdots, \dot{x}_n)^T$$

and  $f_i(t)$  is a continuous function on an interval  $[a, b]$  for integers  $0 \leq i \leq n$ . The following result is well-known for the solutions of  $(LDES^1)$  and  $(LDE^n)$  in references.

**Theorem 1.1**([13]) *If  $F(X)$  is continuous in*

$$U(X_0) : |t - t_0| \leq a, \quad \|X - X_0\| \leq b \quad (a > 0, b > 0)$$

*then there exists a solution  $X(t)$  of differential equation  $(DES^1)$  in the interval  $|t - t_0| \leq h$ , where  $h = \min\{a, b/M\}$ ,  $M = \max_{(t, X) \in U(t_0, X_0)} \|F(t, X)\|$ .*

**Theorem 1.2**([13]) *Let  $\lambda_i$  be the  $k_i$ -fold zero of the characteristic equation*

$$\det(A - \lambda I_{n \times n}) = |A - \lambda I_{n \times n}| = 0$$

*or the characteristic equation*

$$\lambda^n + a_1\lambda^{n-1} + \cdots + a_{n-1}\lambda + a_n = 0$$

*with  $k_1 + k_2 + \cdots + k_s = n$ . Then the general solution of  $(LDES^1)$  is*

$$\sum_{i=1}^n c_i \bar{\beta}_i(t) e^{\alpha_i t},$$

*where,  $c_i$  is a constant,  $\bar{\beta}_i(t)$  is an  $n$ -dimensional vector consisting of polynomials in  $t$  deter-*

mined as follows

$$\begin{aligned}
 \bar{\beta}_1(t) &= \begin{bmatrix} t_{11} \\ t_{21} \\ \dots \\ t_{n1} \end{bmatrix} \\
 \bar{\beta}_2(t) &= \begin{bmatrix} t_{11}t + t_{12} \\ t_{21}t + t_{22} \\ \dots \\ t_{n1}t + t_{n2} \end{bmatrix} \\
 &\dots \\
 \bar{\beta}_{k_1}(t) &= \begin{bmatrix} \frac{t_{11}}{(k_1-1)!}t^{k_1-1} + \frac{t_{12}}{(k_1-2)!}t^{k_1-2} + \dots + t_{1k_1} \\ \frac{t_{21}}{(k_1-1)!}t^{k_1-1} + \frac{t_{22}}{(k_1-2)!}t^{k_1-2} + \dots + t_{2k_1} \\ \dots \\ \frac{t_{n1}}{(k_1-1)!}t^{k_1-1} + \frac{t_{n2}}{(k_1-2)!}t^{k_1-2} + \dots + t_{nk_1} \end{bmatrix} \\
 \bar{\beta}_{k_1+1}(t) &= \begin{bmatrix} t_{1(k_1+1)} \\ t_{2(k_1+1)} \\ \dots \\ t_{n(k_1+1)} \end{bmatrix} \\
 \bar{\beta}_{k_1+2}(t) &= \begin{bmatrix} t_{11}t + t_{12} \\ t_{21}t + t_{22} \\ \dots \\ t_{n1}t + t_{n2} \end{bmatrix} \\
 &\dots \\
 \bar{\beta}_n(t) &= \begin{bmatrix} \frac{t_{1(n-k_s+1)}}{(k_s-1)!}t^{k_s-1} + \frac{t_{1(n-k_s+2)}}{(k_s-2)!}t^{k_s-2} + \dots + t_{1n} \\ \frac{t_{2(n-k_s+1)}}{(k_s-1)!}t^{k_s-1} + \frac{t_{2(n-k_s+2)}}{(k_s-2)!}t^{k_s-2} + \dots + t_{2n} \\ \dots \\ \frac{t_{n(n-k_s+1)}}{(k_s-1)!}t^{k_s-1} + \frac{t_{n(n-k_s+2)}}{(k_s-2)!}t^{k_s-2} + \dots + t_{nn} \end{bmatrix}
 \end{aligned}$$

with each  $t_{ij}$  a real number for  $1 \leq i, j \leq n$  such that  $\det([t_{ij}]_{n \times n}) \neq 0$ ,

$$\alpha_i = \begin{cases} \lambda_1, & \text{if } 1 \leq i \leq k_1; \\ \lambda_2, & \text{if } k_1 + 1 \leq i \leq k_2; \\ \dots & \dots \dots \dots; \\ \lambda_s, & \text{if } k_1 + k_2 + \dots + k_{s-1} + 1 \leq i \leq n. \end{cases}$$

The general solution of linear differential equation ( $LDE^n$ ) is

$$\sum_{i=1}^s (c_{i1}t^{k_i-1} + c_{i2}t^{k_i-2} + \dots + c_{i(k_i-1)}t + c_{ik_i})e^{\lambda_i t},$$

with constants  $c_{ij}$ ,  $1 \leq i \leq s, 1 \leq j \leq k_i$ .

Such a vector family  $\bar{\beta}_i(t)e^{\alpha_i t}$ ,  $1 \leq i \leq n$  of the differential equation system ( $LDES^1$ ) and a family  $t^l e^{\lambda_i t}$ ,  $1 \leq l \leq k_i, 1 \leq i \leq s$  of the linear differential equation ( $LDE^n$ ) are called the *solution basis*, denoted by

$$\mathcal{B} = \{ \bar{\beta}_i(t)e^{\alpha_i t} \mid 1 \leq i \leq n \} \text{ or } \mathcal{C} = \{ t^l e^{\lambda_i t} \mid 1 \leq i \leq s, 1 \leq l \leq k_i \}.$$

We only consider autonomous differential systems in this paper. Theorem 1.2 implies that any linear differential equation system ( $LDES^1$ ) of first order and any differential equation ( $LDE^n$ ) of order  $n$  with real coefficients are solvable. Thus a linear differential equation system of first order is non-solvable only if the number of equations is more than that of variables, and a differential equation system of order  $n \geq 2$  is non-solvable only if the number of equations is more than 2. Generally, such a contradictory system, i.e., a Smarandache system [4]-[6] is defined following.

**Definition 1.3**([4]-[6]) *A rule  $\mathcal{R}$  in a mathematical system  $(\Sigma; \mathcal{R})$  is said to be Smarandachely denied if it behaves in at least two different ways within the same set  $\Sigma$ , i.e., validated and invalidated, or only invalidated but in multiple distinct ways.*

*A Smarandache system  $(\Sigma; \mathcal{R})$  is a mathematical system which has at least one Smarandachely denied rule  $\mathcal{R}$ .*

Generally, let  $(\Sigma_1; \mathcal{R}_1), (\Sigma_2; \mathcal{R}_2), \dots, (\Sigma_m; \mathcal{R}_m)$  be mathematical systems, where  $\mathcal{R}_i$  is a rule on  $\Sigma_i$  for integers  $1 \leq i \leq m$ . If for two integers  $i, j$ ,  $1 \leq i, j \leq m$ ,  $\Sigma_i \neq \Sigma_j$  or  $\Sigma_i = \Sigma_j$  but  $\mathcal{R}_i \neq \mathcal{R}_j$ , then they are said to be *different*, otherwise, *identical*. We also know the conception of Smarandache multi-space defined following.

**Definition 1.4**([4]-[6]) *Let  $(\Sigma_1; \mathcal{R}_1), (\Sigma_2; \mathcal{R}_2), \dots, (\Sigma_m; \mathcal{R}_m)$  be  $m \geq 2$  mathematical spaces, different two by two. A Smarandache multispace  $\tilde{\Sigma}$  is a union  $\bigcup_{i=1}^m \Sigma_i$  with rules  $\tilde{\mathcal{R}} = \bigcup_{i=1}^m \mathcal{R}_i$  on  $\tilde{\Sigma}$ , i.e., the rule  $\mathcal{R}_i$  on  $\Sigma_i$  for integers  $1 \leq i \leq m$ , denoted by  $(\tilde{\Sigma}; \tilde{\mathcal{R}})$ .*

A Smarandache multispace  $(\tilde{\Sigma}; \tilde{\mathcal{R}})$  inherits a combinatorial structure, i.e., a vertex-edge labeled graph defined following.

**Definition 1.5**([4]-[6]) *Let  $(\tilde{\Sigma}; \tilde{\mathcal{R}})$  be a Smarandache multispace with  $\tilde{\Sigma} = \bigcup_{i=1}^m \Sigma_i$  and  $\tilde{\mathcal{R}} = \bigcup_{i=1}^m \mathcal{R}_i$ . Its underlying graph  $G[\tilde{\Sigma}, \tilde{\mathcal{R}}]$  is a labeled simple graph defined by*

$$V(G[\tilde{\Sigma}, \tilde{\mathcal{R}}]) = \{\Sigma_1, \Sigma_2, \dots, \Sigma_m\},$$

$$E \left( G \left[ \tilde{\Sigma}, \tilde{R} \right] \right) = \{ (\Sigma_i, \Sigma_j) \mid \Sigma_i \cap \Sigma_j \neq \emptyset, 1 \leq i, j \leq m \}$$

with an edge labeling

$$l^E : (\Sigma_i, \Sigma_j) \in E \left( G \left[ \tilde{\Sigma}, \tilde{R} \right] \right) \rightarrow l^E(\Sigma_i, \Sigma_j) = \varpi \left( \Sigma_i \cap \Sigma_j \right),$$

where  $\varpi$  is a characteristic on  $\Sigma_i \cap \Sigma_j$  such that  $\Sigma_i \cap \Sigma_j$  is isomorphic to  $\Sigma_k \cap \Sigma_l$  if and only if  $\varpi(\Sigma_i \cap \Sigma_j) = \varpi(\Sigma_k \cap \Sigma_l)$  for integers  $1 \leq i, j, k, l \leq m$ .

Now for integers  $m, n \geq 1$ , let

$$\dot{X} = F_1(X), \dot{X} = F_2(X), \dots, \dot{X} = F_m(X) \tag{DES_m^1}$$

be a differential equation system with continuous  $F_i : \mathbf{R}^n \rightarrow \mathbf{R}^n$  such that  $F_i(\bar{0}) = \bar{0}$ , particularly, let

$$\dot{X} = A_1 X, \dots, \dot{X} = A_k X, \dots, \dot{X} = A_m X \tag{LDES_m^1}$$

be a linear ordinary differential equation system of first order and

$$\begin{cases} x^{(n)} + a_{11}^{[0]}x^{(n-1)} + \dots + a_{1n}^{[0]}x = 0 \\ x^{(n)} + a_{21}^{[0]}x^{(n-1)} + \dots + a_{2n}^{[0]}x = 0 \\ \dots\dots\dots \\ x^{(n)} + a_{m1}^{[0]}x^{(n-1)} + \dots + a_{mn}^{[0]}x = 0 \end{cases} \tag{LDE_m^n}$$

a linear differential equation system of order  $n$  with

$$A_k = \begin{bmatrix} a_{11}^{[k]} & a_{12}^{[k]} & \dots & a_{1n}^{[k]} \\ a_{21}^{[k]} & a_{22}^{[k]} & \dots & a_{2n}^{[k]} \\ \dots & \dots & \dots & \dots \\ a_{n1}^{[k]} & a_{n2}^{[k]} & \dots & a_{nn}^{[k]} \end{bmatrix} \quad \text{and} \quad X = \begin{bmatrix} x_1(t) \\ x_2(t) \\ \dots \\ x_n(t) \end{bmatrix}$$

where each  $a_{ij}^{[k]}$  is a real number for integers  $0 \leq k \leq m, 1 \leq i, j \leq n$ .

**Definition 1.6** An ordinary differential equation system  $(DES_m^1)$  or  $(LDES_m^1)$  (or  $(LDE_m^n)$ ) are called non-solvable if there are no function  $X(t)$  (or  $x(t)$ ) hold with  $(DES_m^1)$  or  $(LDES_m^1)$  (or  $(LDE_m^n)$ ) unless the constants.

The main purpose of this paper is to find contradictory ordinary differential equation systems, characterize the non-solvable spaces of such differential equation systems. For such objective, we are needed to extend the conception of solution of linear differential equations in classical mathematics following.

**Definition 1.7** Let  $S_i^0$  be the solution basis of the  $i$ th equation in  $(DES_m^1)$ . The  $\vee$ -solvable,  $\wedge$ -solvable and non-solvable spaces of differential equation system  $(DES_m^1)$  are respectively defined

by

$$\bigcup_{i=1}^m S_i^0, \quad \bigcap_{i=1}^m S_i^0 \quad \text{and} \quad \bigcup_{i=1}^m S_i^0 - \bigcap_{i=1}^m S_i^0,$$

where  $S_i^0$  is the solution space of the  $i$ th equation in  $(DES_m^1)$ .

According to Theorem 1.2, the general solution of the  $i$ th differential equation in  $(LDES_m^1)$  or the  $i$ th differential equation system in  $(LDE_m^n)$  is a linear space spanned by the elements in the solution basis  $\mathcal{B}_i$  or  $\mathcal{C}_i$  for integers  $1 \leq i \leq m$ . Thus we can simplify the vertex-edge labeled graph  $G[\widetilde{\Sigma}, \widetilde{R}]$  replaced each  $\Sigma_i$  by the solution basis  $\mathcal{B}_i$  (or  $\mathcal{C}_i$ ) and  $\Sigma_i \cap \Sigma_j$  by  $\mathcal{B}_i \cap \mathcal{B}_j$  (or  $\mathcal{C}_i \cap \mathcal{C}_j$ ) if  $\mathcal{B}_i \cap \mathcal{B}_j \neq \emptyset$  (or  $\mathcal{C}_i \cap \mathcal{C}_j \neq \emptyset$ ) for integers  $1 \leq i, j \leq m$ . Such a vertex-edge labeled graph is called the *basis graph* of  $(LDES_m^1)$  ( $(LDE_m^n)$ ), denoted respectively by  $G[LDES_m^1]$  or  $G[LDE_m^n]$  and the underlying graph of  $G[LDES_m^1]$  or  $G[LDE_m^n]$ , i.e., cleared away all labels on  $G[LDES_m^1]$  or  $G[LDE_m^n]$  are denoted by  $\hat{G}[LDES_m^1]$  or  $\hat{G}[LDE_m^n]$ .

Notice that  $\bigcap_{i=1}^m S_i^0 = \bigcup_{i=1}^m S_i^0$ , i.e., the non-solvable space is empty only if  $m = 1$  in  $(LDEq)$ . Thus  $G[LDES_m^1] \simeq K_1$  or  $G[LDE_m^n] \simeq K_1$  only if  $m = 1$ . But in general, the basis graph  $G[LDES_m^1]$  or  $G[LDE_m^n]$  is not trivial. For example, let  $m = 4$  and  $\mathcal{B}_1^0 = \{e^{\lambda_1 t}, e^{\lambda_2 t}, e^{\lambda_3 t}\}$ ,  $\mathcal{B}_2^0 = \{e^{\lambda_3 t}, e^{\lambda_4 t}, e^{\lambda_5 t}\}$ ,  $\mathcal{B}_3^0 = \{e^{\lambda_1 t}, e^{\lambda_3 t}, e^{\lambda_5 t}\}$  and  $\mathcal{B}_4^0 = \{e^{\lambda_4 t}, e^{\lambda_5 t}, e^{\lambda_6 t}\}$ , where  $\lambda_i$ ,  $1 \leq i \leq 6$  are real numbers different two by two. Then its edge-labeled graph  $G[LDES_m^1]$  or  $G[LDE_m^n]$  is shown in Fig.1.

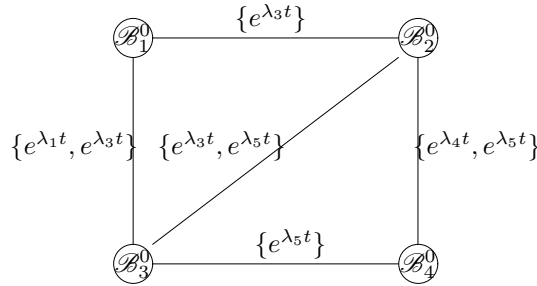

Fig.1

If some functions  $F_i(X)$ ,  $1 \leq i \leq m$  are non-linear in  $(DES_m^1)$ , we can linearize these non-linear equations  $\dot{X} = F_i(X)$  at the point  $\bar{0}$ , i.e., if

$$F_i(X) = F_i'(\bar{0})X + R_i(X),$$

where  $F_i'(\bar{0})$  is an  $n \times n$  matrix, we replace the  $i$ th equation  $\dot{X} = F_i(X)$  by a linear differential equation

$$\dot{X} = F_i'(\bar{0})X$$

in  $(DES_m^1)$ . Whence, we get a uniquely linear differential equation system  $(LDES_m^1)$  from  $(DES_m^1)$  and its basis graph  $G[LDES_m^1]$ . Such a basis graph  $G[LDES_m^1]$  of linearized differential equation system  $(DES_m^1)$  is defined to be the *linearized basis graph* of  $(DES_m^1)$  and denoted by  $G[DES_m^1]$ .

All of these notions will contribute to the characterizing of non-solvable differential equation systems. For terminologies and notations not mentioned here, we follow the [13] for differential equations, [2] for linear algebra, [3]-[6], [11]-[12] for graphs and Smarandache systems, and [1], [12] for mechanics.

## §2. Non-Solvable Linear Ordinary Differential Equations

### 2.1 Characteristics of Non-Solvable Linear Ordinary Differential Equations

First, we know the following conclusion for non-solvable linear differential equation systems  $(LDES_m^1)$  or  $(LDE_m^n)$ .

**Theorem 2.1** *The differential equation system  $(LDES_m^1)$  is solvable if and only if*

$$(|A_1 - \lambda I_{n \times n}, |A_2 - \lambda I_{n \times n}|, \dots, |A_m - \lambda I_{n \times n}|) \neq 1$$

*i.e.,  $(LDEq)$  is non-solvable if and only if*

$$(|A_1 - \lambda I_{n \times n}, |A_2 - \lambda I_{n \times n}|, \dots, |A_m - \lambda I_{n \times n}|) = 1.$$

*Similarly, the differential equation system  $(LDE_m^n)$  is solvable if and only if*

$$(P_1(\lambda), P_2(\lambda), \dots, P_m(\lambda)) \neq 1,$$

*i.e.,  $(LDE_m^n)$  is non-solvable if and only if*

$$(P_1(\lambda), P_2(\lambda), \dots, P_m(\lambda)) = 1,$$

where  $P_i(\lambda) = \lambda^n + a_{i1}^{[0]}\lambda^{n-1} + \dots + a_{i(n-1)}^{[0]}\lambda + a_{in}^{[0]}$  for integers  $1 \leq i \leq m$ .

*Proof* Let  $\lambda_{i1}, \lambda_{i2}, \dots, \lambda_{in}$  be the  $n$  solutions of equation  $|A_i - \lambda I_{n \times n}| = 0$  and  $\mathcal{B}_i$  the solution basis of  $i$ th differential equation in  $(LDES_m^1)$  or  $(LDE_m^n)$  for integers  $1 \leq i \leq m$ . Clearly, if  $(LDES_m^1)$  ( $(LDE_m^n)$ ) is solvable, then

$$\bigcap_{i=1}^m \mathcal{B}_i \neq \emptyset, \quad \text{i.e.,} \quad \bigcap_{i=1}^m \{\lambda_{i1}, \lambda_{i2}, \dots, \lambda_{in}\} \neq \emptyset$$

by Definition 1.5 and Theorem 1.2. Choose  $\lambda_0 \in \bigcap_{i=1}^m \{\lambda_{i1}, \lambda_{i2}, \dots, \lambda_{in}\}$ . Then  $(\lambda - \lambda_0)$  is a common divisor of these polynomials  $|A_1 - \lambda I_{n \times n}|, |A_2 - \lambda I_{n \times n}|, \dots, |A_m - \lambda I_{n \times n}|$ . Thus

$$(|A_1 - \lambda I_{n \times n}, |A_2 - \lambda I_{n \times n}|, \dots, |A_m - \lambda I_{n \times n}|) \neq 1.$$

Conversely, if

$$(|A_1 - \lambda I_{n \times n}, |A_2 - \lambda I_{n \times n}|, \dots, |A_m - \lambda I_{n \times n}|) \neq 1,$$

let  $(\lambda - \lambda_{01}), (\lambda - \lambda_{02}), \dots, (\lambda - \lambda_{0l})$  be all the common divisors of polynomials  $|A_1 - \lambda I_{n \times n}|, |A_2 - \lambda I_{n \times n}|, \dots, |A_m - \lambda I_{n \times n}|$ , where  $\lambda_{0i} \neq \lambda_{0j}$  if  $i \neq j$  for  $1 \leq i, j \leq l$ . Then it is clear that

$$C_1 e^{\lambda_{01}} + C_2 e^{\lambda_{02}} + \dots + C_l e^{\lambda_{0l}}$$

is a solution of  $(LEDq)$  ( $(LDE_m^n)$ ) for constants  $C_1, C_2, \dots, C_l$ .  $\square$

For discussing the non-solvable space of a linear differential equation system  $(LEDS_m^1)$  or  $(LDE_m^n)$  in details, we introduce the following conception.

**Definition 2.2** For two integers  $1 \leq i, j \leq m$ , the differential equations

$$\begin{cases} \frac{dX_i}{dt} = A_i X \\ \frac{dX_j}{dt} = A_j X \end{cases} \quad (LEDS_{ij}^1)$$

in  $(LDES_m^1)$  or

$$\begin{cases} x^{(n)} + a_{i1}^{[0]} x^{(n-1)} + \dots + a_{in}^{[0]} x = 0 \\ x^{(n)} + a_{j1}^{[0]} x^{(n-1)} + \dots + a_{jn}^{[0]} x = 0 \end{cases} \quad (LDE_{ij}^n)$$

in  $(LDE_m^n)$  are parallel if  $\mathcal{B}_i \cap \mathcal{B}_j = \emptyset$ .

Then, the following conclusion is clear.

**Theorem 2.3** For two integers  $1 \leq i, j \leq m$ , two differential equations  $(LEDS_{ij}^1)$  (or  $(LDE_{ij}^n)$ ) are parallel if and only if

$$(|A_i| - \lambda I_{n \times n}, |A_j| - \lambda I_{n \times n}) = 1 \quad (\text{or } (P_i(\lambda), P_j(\lambda)) = 1),$$

where  $(f(x), g(x))$  is the least common divisor of  $f(x)$  and  $g(x)$ ,  $P_k(\lambda) = \lambda^n + a_{k1}^{[0]} \lambda^{n-1} + \dots + a_{k(n-1)}^{[0]} \lambda + a_{kn}^{[0]}$  for  $k = i, j$ .

*Proof* By definition, two differential equations  $(LEDS_{ij}^1)$  in  $(LDES_m^1)$  are parallel if and only if the characteristic equations

$$|A_i - \lambda I_{n \times n}| = 0 \quad \text{and} \quad |A_j - \lambda I_{n \times n}| = 0$$

have no same roots. Thus the polynomials  $|A_i| - \lambda I_{n \times n}$  and  $|A_j| - \lambda I_{n \times n}$  are coprime, which means that

$$(|A_i - \lambda I_{n \times n}, |A_j - \lambda I_{n \times n}|) = 1.$$

Similarly, two differential equations  $(LED_{ij}^n)$  in  $(LDE_m^n)$  are parallel if and only if the

characteristic equations  $P_i(\lambda) = 0$  and  $P_j(\lambda) = 0$  have no same roots, i.e.,  $(P_i(\lambda), P_j(\lambda)) = 1$ .  $\square$

Let  $f(x) = a_0x^m + a_1x^{m-1} + \dots + a_{m-1}x + a_m$ ,  $g(x) = b_0x^n + b_1x^{n-1} + \dots + b_{n-1}x + b_n$  with roots  $x_1, x_2, \dots, x_m$  and  $y_1, y_2, \dots, y_n$ , respectively. A *resultant*  $R(f, g)$  of  $f(x)$  and  $g(x)$  is defined by

$$R(f, g) = a_0^m b_0^n \prod_{i,j} (x_i - y_j).$$

The following result is well-known in polynomial algebra.

**Theorem 2.4** *Let  $f(x) = a_0x^m + a_1x^{m-1} + \dots + a_{m-1}x + a_m$ ,  $g(x) = b_0x^n + b_1x^{n-1} + \dots + b_{n-1}x + b_n$  with roots  $x_1, x_2, \dots, x_m$  and  $y_1, y_2, \dots, y_n$ , respectively. Define a matrix*

$$V(f, g) = \begin{bmatrix} a_0 & a_1 & \dots & a_m & 0 & \dots & 0 & 0 \\ 0 & a_0 & a_1 & \dots & a_m & 0 & \dots & 0 \\ \dots & \dots & \dots & \dots & \dots & \dots & \dots & \dots \\ 0 & \dots & 0 & 0 & a_0 & a_1 & \dots & a_m \\ b_0 & b_1 & \dots & b_n & 0 & \dots & 0 & 0 \\ 0 & b_0 & b_1 & \dots & b_n & 0 & \dots & 0 \\ \dots & \dots & \dots & \dots & \dots & \dots & \dots & \dots \\ 0 & \dots & 0 & 0 & b_0 & b_1 & \dots & b_n \end{bmatrix}$$

Then

$$R(f, g) = \det V(f, g).$$

We get the following result immediately by Theorem 2.3.

**Corollary 2.5** (1) *For two integers  $1 \leq i, j \leq m$ , two differential equations  $(LDES_{ij}^1)$  are parallel in  $(LDES_m^1)$  if and only if*

$$R(|A_i - \lambda I_{n \times n}|, |A_j - \lambda I_{n \times n}|) \neq 0,$$

particularly, the homogenous equations

$$V(|A_i - \lambda I_{n \times n}|, |A_j - \lambda I_{n \times n}|)X = 0$$

have only solution  $\underbrace{(0, 0, \dots, 0)^T}_{2n}$  if  $|A_i - \lambda I_{n \times n}| = a_0\lambda^n + a_1\lambda^{n-1} + \dots + a_{n-1}\lambda + a_n$  and  $|A_j - \lambda I_{n \times n}| = b_0\lambda^n + b_1\lambda^{n-1} + \dots + b_{n-1}\lambda + b_n$ .

(2) *For two integers  $1 \leq i, j \leq m$ , two differential equations  $(LDE_{ij}^n)$  are parallel in  $(LDE_m^n)$  if and only if*

$$R(P_i(\lambda), P_j(\lambda)) \neq 0,$$



particularly, the homogenous equations  $V(P_i(\lambda), P_j(\lambda))X = 0$  have only solution  $\underbrace{(0, 0, \dots, 0)}_{2n}^T$ .

*Proof* Clearly,  $|A_i - \lambda I_{n \times n}|$  and  $|A_j - \lambda I_{n \times n}|$  have no same roots if and only if

$$R(|A_i - \lambda I_{n \times n}|, |A_j - \lambda I_{n \times n}|) \neq 0,$$

which implies that the two differential equations  $(LEDS_{ij}^1)$  are parallel in  $(LEDS_m^1)$  and the homogenous equations

$$V(|A_i - \lambda I_{n \times n}|, |A_j - \lambda I_{n \times n}|)X = 0$$

have only solution  $\underbrace{(0, 0, \dots, 0)}_{2n}^T$ . That is the conclusion (1). The proof for the conclusion (2) is similar. □

Applying Corollary 2.5, we can determine that an edge  $(\mathcal{B}_i, \mathcal{B}_j)$  does not exist in  $G[LDES_m^1]$  or  $G[LDE_m^n]$  if and only if the  $i$ th differential equation is parallel with the  $j$ th differential equation in  $(LDES_m^1)$  or  $(LDE_m^n)$ . This fact enables one to know the following result on linear non-solvable differential equation systems.

**Corollary 2.6** *A linear differential equation system  $(LDES_m^1)$  or  $(LDE_m^n)$  is non-solvable if  $\hat{G}(LDES_m^1) \not\cong K_m$  or  $\hat{G}(LDE_m^n) \not\cong K_m$  for integers  $m, n > 1$ .*

## 2.2 A Combinatorial Classification of Linear Differential Equations

There is a natural relation between linear differential equations and basis graphs shown in the following result.

**Theorem 2.7** *Every linear homogeneous differential equation system  $(LDES_m^1)$  (or  $(LDE_m^n)$ ) uniquely determines a basis graph  $G[LDES_m^1]$  ( $G[LDE_m^n]$ ) inherited in  $(LDES_m^1)$  (or in  $(LDE_m^n)$ ). Conversely, every basis graph  $G$  uniquely determines a homogeneous differential equation system  $(LDES_m^1)$  ( or  $(LDE_m^n)$ ) such that  $G[LDES_m^1] \simeq G$  (or  $G[LDE_m^n] \simeq G$ ).*

*Proof* By Definition 1.4, every linear homogeneous differential equation system  $(LDES_m^1)$  or  $(LDE_m^n)$  inherits a basis graph  $G[LDES_m^1]$  or  $G[LDE_m^n]$ , which is uniquely determined by  $(LDES_m^1)$  or  $(LDE_m^n)$ .

Now let  $G$  be a basis graph. For  $\forall v \in V(G)$ , let the basis  $\mathcal{B}_v$  at the vertex  $v$  be  $\mathcal{B}_v = \{ \bar{\beta}_i(t)e^{\alpha_i t} \mid 1 \leq i \leq n_v \}$  with

$$\alpha_i = \begin{cases} \lambda_1, & \text{if } 1 \leq i \leq k_1; \\ \lambda_2, & \text{if } k_1 + 1 \leq i \leq k_2; \\ \dots & \dots\dots\dots; \\ \lambda_s, & \text{if } k_1 + k_2 + \dots + k_{s-1} + 1 \leq i \leq n_v \end{cases}$$

We construct a linear homogeneous differential equation  $(LDES^1)$  associated at the vertex  $v$ .

By Theorem 1.2, we know the matrix

$$T = \begin{bmatrix} t_{11} & t_{12} & \cdots & t_{1n_v} \\ t_{21} & t_{22} & \cdots & t_{2n_v} \\ \cdots & \cdots & \cdots & \cdots \\ t_{n_v 1} & t_{n_v 2} & \cdots & t_{n_v n_v} \end{bmatrix}$$

is non-degenerate. For an integer  $i$ ,  $1 \leq i \leq s$ , let

$$J_i = \begin{bmatrix} \lambda_i & 1 & 0 & \cdots & 0 & 0 \\ 0 & \lambda_i & 1 & 0 & \cdots & 0 \\ \cdots & \cdots & \cdots & \cdots & \cdots & \cdots \\ 0 & 0 & \cdots & 0 & 0 & \lambda_i \end{bmatrix}$$

be a Jordan block of  $k_i \times k_i$  and

$$A = T \begin{bmatrix} J_1 & & & O \\ & J_2 & & \\ & & \ddots & \\ O & & & J_s \end{bmatrix} T^{-1}.$$

Then we are easily know the solution basis of the linear differential equation system

$$\frac{dX}{dt} = AX \quad (LDES^1)$$

with  $X = [x_1(t), x_2(t), \dots, x_{n_v}(t)]^T$  is nothing but  $\mathcal{B}_v$  by Theorem 1.2. Notice that the Jordan block and the matrix  $T$  are uniquely determined by  $\mathcal{B}_v$ . Thus the linear homogeneous differential equation  $(LDES^1)$  is uniquely determined by  $\mathcal{B}_v$ . It should be noted that this construction can be processed on each vertex  $v \in V(G)$ . We finally get a linear homogeneous differential equation system  $(LDES_m^1)$ , which is uniquely determined by the basis graph  $G$ .

Similarly, we construct the linear homogeneous differential equation system  $(LDE_m^n)$  for the basis graph  $G$ . In fact, for  $\forall u \in V(G)$ , let the basis  $\mathcal{B}_u$  at the vertex  $u$  be  $\mathcal{B}_u = \{t^l e^{\lambda_i t} \mid 1 \leq i \leq s, 1 \leq l \leq k_i\}$ . Notice that  $\lambda_i$  should be a  $k_i$ -fold zero of the characteristic equation  $P(\lambda) = 0$  with  $k_1 + k_2 + \cdots + k_s = n$ . Thus  $P(\lambda_i) = P'(\lambda_i) = \cdots = P^{(k_i-1)}(\lambda_i) = 0$  but  $P^{(k_i)}(\lambda_i) \neq 0$  for integers  $1 \leq i \leq s$ . Define a polynomial  $P_u(\lambda)$  following

$$P_u(\lambda) = \prod_{i=1}^s (\lambda - \lambda_i)^{k_i}$$

associated with the vertex  $u$ . Let its expansion be

$$P_u(\lambda) = \lambda^n + a_{u1}\lambda^{n-1} + \cdots + a_{u(n-1)}\lambda + a_{un}.$$

Now we construct a linear homogeneous differential equation

$$x^{(n)} + a_{u1}x^{(n-1)} + \dots + a_{u(n-1)}x' + a_{un}x = 0 \tag{L^h DE^n}$$

associated with the vertex  $u$ . Then by Theorem 1.2 we know that the basis solution of  $(LDE^n)$  is just  $\mathcal{C}_u$ . Notices that such a linear homogeneous differential equation  $(LDE^n)$  is uniquely constructed. Processing this construction for every vertex  $u \in V(G)$ , we get a linear homogeneous differential equation system  $(LDE_m^n)$ . This completes the proof.  $\square$

**Example 2.8** Let  $(LDE_m^n)$  be the following linear homogeneous differential equation system

$$\begin{cases} \ddot{x} - 3\dot{x} + 2x = 0 & (1) \\ \ddot{x} - 5\dot{x} + 6x = 0 & (2) \\ \ddot{x} - 7\dot{x} + 12x = 0 & (3) \\ \ddot{x} - 9\dot{x} + 20x = 0 & (4) \\ \ddot{x} - 11\dot{x} + 30x = 0 & (5) \\ \ddot{x} - 7\dot{x} + 6x = 0 & (6) \end{cases}$$

where  $\ddot{x} = \frac{d^2x}{dt^2}$  and  $\dot{x} = \frac{dx}{dt}$ . Then the solution basis of equations (1) – (6) are respectively  $\{e^t, e^{2t}\}, \{e^{2t}, e^{3t}\}, \{e^{3t}, e^{4t}\}, \{e^{4t}, e^{5t}\}, \{e^{5t}, e^{6t}\}, \{e^{6t}, e^t\}$  and its basis graph is shown in Fig.2.

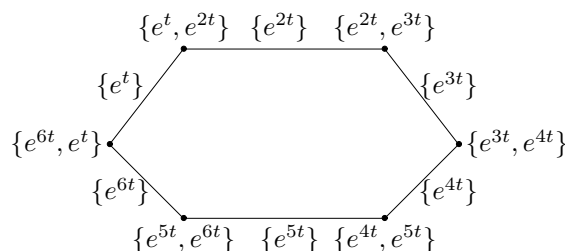

**Fig.2 The basis graph H**

Theorem 2.7 enables one to extend the conception of solution of linear differential equation to the following.

**Definition 2.9** A basis graph  $G[LDES_m^1]$  (or  $G[LDE_m^n]$ ) is called the graph solution of the linear homogeneous differential equation system  $(LDES_m^1)$  (or  $(LDE_m^n)$ ), abbreviated to  $G$ -solution.

The following result is an immediately conclusion of Theorem 3.1 by definition.

**Theorem 2.10** Every linear homogeneous differential equation system  $(LDES_m^1)$  (or  $(LDE_m^n)$ ) has a unique  $G$ -solution, and for every basis graph  $H$ , there is a unique linear homogeneous differential equation system  $(LDES_m^1)$  (or  $(LDE_m^n)$ ) with  $G$ -solution  $H$ .

Theorem 2.10 implies that one can classify the linear homogeneous differential equation systems by those of basis graphs.

**Definition 2.11** Let  $(LDES_m^1)$ ,  $(LDES_m^1)'$  (or  $(LDE_m^n)$ ,  $(LDE_m^n)'$ ) be two linear homogeneous differential equation systems with  $G$ -solutions  $H$ ,  $H'$ . They are called combinatorially equivalent if there is an isomorphism  $\varphi : H \rightarrow H'$ , thus there is an isomorphism  $\varphi : H \rightarrow H'$  of graph and labelings  $\theta, \tau$  on  $H$  and  $H'$  respectively such that  $\varphi\theta(x) = \tau\varphi(x)$  for  $\forall x \in V(H) \cup E(H)$ , denoted by  $(LDES_m^1) \stackrel{\cong}{\sim} (LDES_m^1)'$  (or  $(LDE_m^n) \stackrel{\cong}{\sim} (LDE_m^n)'$ ).

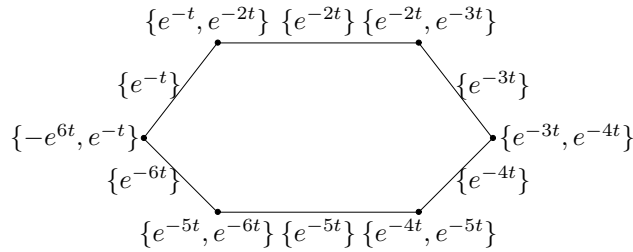

**Fig.3 The basis graph  $H'$**

**Example 2.12** Let  $(LDE_m^n)'$  be the following linear homogeneous differential equation system

$$\begin{cases} \ddot{x} + 3\dot{x} + 2x = 0 & (1) \\ \ddot{x} + 5\dot{x} + 6x = 0 & (2) \\ \ddot{x} + 7\dot{x} + 12x = 0 & (3) \\ \ddot{x} + 9\dot{x} + 20x = 0 & (4) \\ \ddot{x} + 11\dot{x} + 30x = 0 & (5) \\ \ddot{x} + 7\dot{x} + 6x = 0 & (6) \end{cases}$$

Then its basis graph is shown in Fig.3.

Let  $\varphi : H \rightarrow H'$  be determined by  $\varphi(\{e^{\lambda_i t}, e^{\lambda_j t}\}) = \{e^{-\lambda_i t}, e^{-\lambda_j t}\}$  and

$$\varphi(\{e^{\lambda_i t}, e^{\lambda_j t}\} \cap \{e^{\lambda_k t}, e^{\lambda_l t}\}) = \{e^{-\lambda_i t}, e^{-\lambda_j t}\} \cap \{e^{-\lambda_k t}, e^{-\lambda_l t}\}$$

for integers  $1 \leq i, k \leq 6$  and  $j = i + 1 \equiv 6(\text{mod}6)$ ,  $l = k + 1 \equiv 6(\text{mod}6)$ . Then it is clear that  $H \stackrel{\cong}{\sim} H'$ . Thus  $(LDE_m^n)'$  is combinatorially equivalent to the linear homogeneous differential equation system  $(LDE_m^n)$  appeared in Example 2.8.

**Definition 2.13** Let  $G$  be a simple graph. A vertex-edge labeled graph  $\theta : G \rightarrow \mathbb{Z}^+$  is called integral if  $\theta(uv) \leq \min\{\theta(u), \theta(v)\}$  for  $\forall uv \in E(G)$ , denoted by  $G^{I_\theta}$ .

Let  $G_1^{I_\theta}$  and  $G_2^{I_\tau}$  be two integral labeled graphs. They are called identical if  $G_1 \stackrel{\cong}{\sim} G_2$  and  $\theta(x) = \tau(\varphi(x))$  for any graph isomorphism  $\varphi$  and  $\forall x \in V(G_1) \cup E(G_1)$ , denoted by  $G_1^{I_\theta} = G_2^{I_\tau}$ .

For example, these labeled graphs shown in Fig.4 are all integral on  $K_4 - e$ , but  $G_1^{I_\theta} = G_2^{I_\tau}$ ,

$$G_1^{I_\theta} \neq G_3^{I_\sigma}.$$

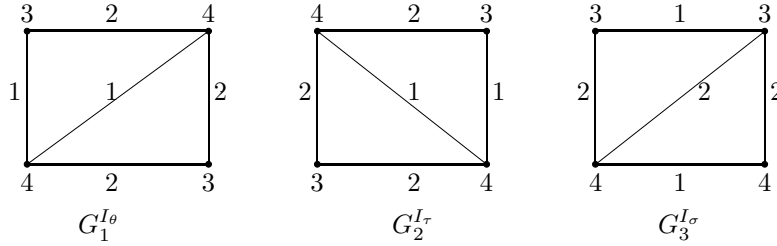

Fig.4

Let  $G[LDES_m^1]$  ( $G[LDE_m^n]$ ) be a basis graph of the linear homogeneous differential equation system  $(LDES_m^1)$  (or  $(LDE_m^n)$ ) labeled each  $v \in V(G[LDES_m^1])$  (or  $v \in V(G[LDE_m^n])$ ) by  $\mathcal{B}_v$ . We are easily get a vertex-edge labeled graph by relabeling  $v \in V(G[LDES_m^1])$  (or  $v \in V(G[LDE_m^n])$ ) by  $|\mathcal{B}_v|$  and  $uv \in E(G[LDES_m^1])$  (or  $uv \in E(G[LDE_m^n])$ ) by  $|\mathcal{B}_u \cap \mathcal{B}_v|$ . Obviously, such a vertex-edge labeled graph is integral, and denoted by  $G^I[LDES_m^1]$  (or  $G^I[LDE_m^n]$ ). The following result completely characterizes combinatorially equivalent linear homogeneous differential equation systems.

**Theorem 2.14** *Let  $(LDES_m^1)$ ,  $(LDES_m^1)'$  (or  $(LDE_m^n)$ ,  $(LDE_m^n)'$ ) be two linear homogeneous differential equation systems with integral labeled graphs  $H$ ,  $H'$ . Then  $(LDES_m^1) \overset{\cong}{\simeq} (LDES_m^1)'$  (or  $(LDE_m^n) \overset{\cong}{\simeq} (LDE_m^n)'$ ) if and only if  $H = H'$ .*

*Proof* Clearly,  $H = H'$  if  $(LDES_m^1) \overset{\cong}{\simeq} (LDES_m^1)'$  (or  $(LDE_m^n) \overset{\cong}{\simeq} (LDE_m^n)'$ ) by definition. We prove the converse, i.e., if  $H = H'$  then there must be  $(LDES_m^1) \overset{\cong}{\simeq} (LDES_m^1)'$  (or  $(LDE_m^n) \overset{\cong}{\simeq} (LDE_m^n)'$ ).

Notice that there is an objection between two finite sets  $S_1, S_2$  if and only if  $|S_1| = |S_2|$ . Let  $\tau$  be a 1 – 1 mapping from  $\mathcal{B}_v$  on basis graph  $G[LDES_m^1]$  (or basis graph  $G[LDE_m^n]$ ) to  $\mathcal{B}_{v'}$  on basis graph  $G[LDES_m^1]'$  (or basis graph  $G[LDE_m^n]'$ ) for  $v, v' \in V(H')$ . Now if  $H = H'$ , we can easily extend the identical isomorphism  $id_H$  on graph  $H$  to a 1 – 1 mapping  $id_H^* : G[LDES_m^1] \rightarrow G[LDES_m^1]'$  (or  $id_H^* : G[LDE_m^n] \rightarrow G[LDE_m^n]'$ ) with labelings  $\theta : v \rightarrow \mathcal{B}_v$  and  $\theta'_{v'} : v' \rightarrow \mathcal{B}_{v'}$  on  $G[LDES_m^1]$ ,  $G[LDES_m^1]'$  (or basis graphs  $G[LDE_m^n]$ ,  $G[LDE_m^n]'$ ). Then it is an immediately to check that  $id_H^* \theta(x) = \theta' \tau(x)$  for  $\forall x \in V(G[LDES_m^1]) \cup E(G[LDES_m^1])$  (or for  $\forall x \in V(G[LDE_m^n]) \cup E(G[LDE_m^n])$ ). Thus  $id_H^*$  is an isomorphism between basis graphs  $G[LDES_m^1]$  and  $G[LDES_m^1]'$  (or  $G[LDE_m^n]$  and  $G[LDE_m^n]'$ ). Thus  $(LDES_m^1) \overset{id_H^*}{\simeq} (LDES_m^1)'$  (or  $(LDE_m^n) \overset{id_H^*}{\simeq} (LDE_m^n)'$ ). This completes the proof.  $\square$

According to Theorem 2.14, all linear homogeneous differential equation systems  $(LDES_m^1)$  or  $(LDE_m^n)$  can be classified by  $G$ -solutions into the following classes:

**Class 1.**  $\hat{G}[LDES_m^1] \simeq \overline{K}_m$  or  $\hat{G}[LDE_m^n] \simeq \overline{K}_m$  for integers  $m, n \geq 1$ .

The  $G$ -solutions of differential equation systems are labeled by solution bases on  $\overline{K}_m$  and any two linear differential equations in  $(LDES_m^1)$  or  $(LDE_m^n)$  are parallel, which characterizes

$m$  isolated systems in this class.

For example, the following differential equation system

$$\begin{cases} \ddot{x} + 3\dot{x} + 2x = 0 \\ \ddot{x} - 5\dot{x} + 6x = 0 \\ \ddot{x} + 2\dot{x} - 3x = 0 \end{cases}$$

is of Class 1.

**Class 2.**  $\hat{G}[LDES_m^1] \simeq K_m$  or  $\hat{G}[LDE_m^n] \simeq K_m$  for integers  $m, n \geq 1$ .

The  $G$ -solutions of differential equation systems are labeled by solution bases on complete graphs  $K_m$  in this class. By Corollary 2.6, we know that  $\hat{G}[LDES_m^1] \simeq K_m$  or  $\hat{G}[LDE_m^n] \simeq K_m$  if  $(LDES_m^1)$  or  $(LDE_m^n)$  is solvable. In fact, this implies that

$$\bigcap_{v \in V(K_m)} \mathcal{B}_v = \bigcap_{u, v \in V(K_m)} (\mathcal{B}_u \cap \mathcal{B}_v) \neq \emptyset.$$

Otherwise,  $(LDES_m^1)$  or  $(LDE_m^n)$  is non-solvable.

For example, the underlying graphs of linear differential equation systems (A) and (B) in the following

$$(A) \quad \begin{cases} \ddot{x} - 3\dot{x} + 2x = 0 \\ \ddot{x} - x = 0 \\ \ddot{x} - 4\dot{x} + 3x = 0 \\ \ddot{x} + 2\dot{x} - 3x = 0 \end{cases} \quad (B) \quad \begin{cases} \ddot{x} - 3\dot{x} + 2x = 0 \\ \ddot{x} - 5\dot{x} + 6x = 0 \\ \ddot{x} - 4\dot{x} + 3x = 0 \end{cases}$$

are respectively  $K_4$ ,  $K_3$ . It is easily to know that (A) is solvable, but (B) is not.

**Class 3.**  $\hat{G}[LDES_m^1] \simeq G$  or  $\hat{G}[LDE_m^n] \simeq G$  with  $|G| = m$  but  $G \not\simeq K_m$ ,  $\overline{K}_m$  for integers  $m, n \geq 1$ .

The  $G$ -solutions of differential equation systems are labeled by solution bases on  $G$  and all linear differential equation systems  $(LDES_m^1)$  or  $(LDE_m^n)$  are non-solvable in this class, such as those shown in Example 2.12.

### 2.3 Global Stability of Linear Differential Equations

The following result on the initial problem of  $(LDES^1)$  and  $(LDE^n)$  are well-known for differential equations.

**Lemma 2.15**([13]) *For  $t \in [0, \infty)$ , there is a unique solution  $X(t)$  for the linear homogeneous differential equation system*

$$\frac{dX}{dt} = AX \quad (L^hDES^1)$$

with  $X(0) = X_0$  and a unique solution for

$$x^{(n)} + a_1x^{(n-1)} + \cdots + a_nx = 0 \quad (L^hDE^n)$$

with  $x(0) = x_0, x'(0) = x'_0, \dots, x^{(n-1)}(0) = x_0^{(n-1)}$ .

Applying Lemma 2.15, we get easily a conclusion on the  $G$ -solution of  $(LDES_m^1)$  with  $X_v(0) = X_0^v$  for  $\forall v \in V(G)$  or  $(LDE_m^n)$  with  $x(0) = x_0, x'(0) = x'_0, \dots, x^{(n-1)}(0) = x_0^{(n-1)}$  by Theorem 2.10 following.

**Theorem 2.16** For  $t \in [0, \infty)$ , there is a unique  $G$ -solution for a linear homogeneous differential equation systems  $(LDES_m^1)$  with initial value  $X_v(0)$  or  $(LDE_m^n)$  with initial values  $x_v(0), x'_v(0), \dots, x_v^{(n-1)}(0)$  for  $\forall v \in V(G)$ .

For discussing the stability of linear homogeneous differential equations, we introduce the conceptions of zero  $G$ -solution and equilibrium point of that  $(LDES_m^1)$  or  $(LDE_m^n)$  following.

**Definition 2.17** A  $G$ -solution of a linear differential equation system  $(LDES_m^1)$  with initial value  $X_v(0)$  or  $(LDE_m^n)$  with initial values  $x_v(0), x'_v(0), \dots, x_v^{(n-1)}(0)$  for  $\forall v \in V(G)$  is called a zero  $G$ -solution if each label  $\mathcal{B}_i$  of  $G$  is replaced by  $(0, \dots, 0)$  ( $|\mathcal{B}_i|$  times) and  $\mathcal{B}_i \cap \mathcal{B}_j$  by  $(0, \dots, 0)$  ( $|\mathcal{B}_i \cap \mathcal{B}_j|$  times) for integers  $1 \leq i, j \leq m$ .

**Definition 2.18** Let  $dX/dt = A_vX$ ,  $x^{(n)} + a_{v1}x^{(n-1)} + \cdots + a_{vn}x = 0$  be differential equations associated with vertex  $v$  and  $H$  a spanning subgraph of  $G[LDES_m^1]$  (or  $G[LDE_m^n]$ ). A point  $X^* \in \mathbf{R}^n$  is called a  $H$ -equilibrium point if  $A_vX^* = \bar{0}$  in  $(LDES_m^1)$  with initial value  $X_v(0)$  or  $(X^*)^n + a_{v1}(X^*)^{n-1} + \cdots + a_{vn}X^* = \bar{0}$  in  $(LDE_m^n)$  with initial values  $x_v(0), x'_v(0), \dots, x_v^{(n-1)}(0)$  for  $\forall v \in V(H)$ .

We consider only two kind of stabilities on the zero  $G$ -solution of linear homogeneous differential equations in this section. One is the sum-stability. Another is the prod-stability.

### 2.3.1 Sum-Stability

**Definition 2.19** Let  $H$  be a spanning subgraph of  $G[LDES_m^1]$  or  $G[LDE_m^n]$  of the linear homogeneous differential equation systems  $(LDES_m^1)$  with initial value  $X_v(0)$  or  $(LDE_m^n)$  with initial values  $x_v(0), x'_v(0), \dots, x_v^{(n-1)}(0)$ . Then  $G[LDES_m^1]$  or  $G[LDE_m^n]$  is called sum-stable or asymptotically sum-stable on  $H$  if for all solutions  $Y_v(t)$ ,  $v \in V(H)$  of the linear differential equations of  $(LDES_m^1)$  or  $(LDE_m^n)$  with  $|Y_v(0) - X_v(0)| < \delta_v$  exists for all  $t \geq 0$ ,  $|\sum_{v \in V(H)} Y_v(t) - \sum_{v \in V(H)} X_v(t)| < \varepsilon$ , or furthermore,  $\lim_{t \rightarrow 0} |\sum_{v \in V(H)} Y_v(t) - \sum_{v \in V(H)} X_v(t)| = 0$ .

Clearly, an asymptotic sum-stability implies the sum-stability of that  $G[LDES_m^1]$  or  $G[LDE_m^n]$ . The next result shows the relation of sum-stability with that of classical stability.

**Theorem 2.20** For a  $G$ -solution  $G[LDES_m^1]$  of  $(LDES_m^1)$  with initial value  $X_v(0)$  (or  $G[LDE_m^n]$  of  $(LDE_m^n)$  with initial values  $x_v(0), x'_v(0), \dots, x_v^{(n-1)}(0)$ ), let  $H$  be a spanning subgraph of

$G[LDES_m^1]$  (or  $G[LDE_m^n]$ ) and  $X^*$  an equilibrium point on subgraphs  $H$ . If  $G[LDES_m^1]$  (or  $G[LDE_m^n]$ ) is stable on any  $\forall v \in V(H)$ , then  $G[LDES_m^1]$  (or  $G[LDE_m^n]$ ) is sum-stable on  $H$ . Furthermore, if  $G[LDES_m^1]$  (or  $G[LDE_m^n]$ ) is asymptotically sum-stable for at least one vertex  $v \in V(H)$ , then  $G[LDES_m^1]$  (or  $G[LDE_m^n]$ ) is asymptotically sum-stable on  $H$ .

*Proof* Notice that

$$\left| \sum_{v \in V(H)} p_v Y_v(t) - \sum_{v \in V(H)} p_v X_v(t) \right| \leq \sum_{v \in V(H)} p_v |Y_v(t) - X_v(t)|$$

and

$$\lim_{t \rightarrow 0} \left| \sum_{v \in V(H)} p_v Y_v(t) - \sum_{v \in V(H)} p_v X_v(t) \right| \leq \sum_{v \in V(H)} p_v \lim_{t \rightarrow 0} |Y_v(t) - X_v(t)|.$$

Then the conclusion on sum-stability follows. □

For linear homogenous differential equations ( $LDES^1$ ) (or ( $LDE^n$ )), the following result on stability of its solution  $X(t) = \bar{0}$  (or  $x(t) = 0$ ) is well-known.

**Lemma 2.21** *Let  $\gamma = \max\{ \operatorname{Re}\lambda \mid |A - \lambda I_{n \times n}| = 0 \}$ . Then the stability of the trivial solution  $X(t) = \bar{0}$  of linear homogenous differential equations ( $LDES^1$ ) (or  $x(t) = 0$  of ( $LDE^n$ )) is determined as follows:*

- (1) if  $\gamma < 0$ , then it is asymptotically stable;
- (2) if  $\gamma > 0$ , then it is unstable;
- (3) if  $\gamma = 0$ , then it is not asymptotically stable, and stable if and only if  $m'(\lambda) = m(\lambda)$  for every  $\lambda$  with  $\operatorname{Re}\lambda = 0$ , where  $m(\lambda)$  is the algebraic multiplicity and  $m'(\lambda)$  the dimension of eigenspace of  $\lambda$ .

By Theorem 2.20 and Lemma 2.21, the following result on the stability of zero  $G$ -solution of ( $LDES_m^1$ ) and ( $LDE_m^n$ ) is obtained.

**Theorem 2.22** *A zero  $G$ -solution of linear homogenous differential equation systems ( $LDES_m^1$ ) (or ( $LDE_m^n$ )) is asymptotically sum-stable on a spanning subgraph  $H$  of  $G[LDES_m^1]$  (or  $G[LDE_m^n]$ ) if and only if  $\operatorname{Re}\alpha_v < 0$  for each  $\bar{\beta}_v(t)e^{\alpha_v t} \in \mathcal{B}_v$  in ( $LDES^1$ ) or  $\operatorname{Re}\lambda_v < 0$  for each  $t^{l_v}e^{\lambda_v t} \in \mathcal{C}_v$  in ( $LDE_m^n$ ) hold for  $\forall v \in V(H)$ .*

*Proof* The sufficiency is an immediately conclusion of Theorem 2.20.

Conversely, if there is a vertex  $v \in V(H)$  such that  $\operatorname{Re}\alpha_v \geq 0$  for  $\bar{\beta}_v(t)e^{\alpha_v t} \in \mathcal{B}_v$  in ( $LDES^1$ ) or  $\operatorname{Re}\lambda_v \geq 0$  for  $t^{l_v}e^{\lambda_v t} \in \mathcal{C}_v$  in ( $LDE_m^n$ ), then we are easily knowing that

$$\lim_{t \rightarrow \infty} \bar{\beta}_v(t)e^{\alpha_v t} \rightarrow \infty$$

if  $\alpha_v > 0$  or  $\bar{\beta}_v(t) \neq \text{constant}$ , and

$$\lim_{t \rightarrow \infty} t^{l_v}e^{\lambda_v t} \rightarrow \infty$$

if  $\lambda_v > 0$  or  $l_v > 0$ , which implies that the zero  $G$ -solution of linear homogenous differential



equation systems  $(LDES^1)$  or  $(LDE^n)$  is not asymptotically sum-stable on  $H$ . □

The following result of Hurwitz on real number of eigenvalue of a characteristic polynomial is useful for determining the asymptotically stability of the zero  $G$ -solution of  $(LDES_m^1)$  and  $(LDE_m^n)$ .

**Lemma 2.23** *Let  $P(\lambda) = \lambda^n + a_1\lambda^{n-1} + \dots + a_{n-1}\lambda + a_n$  be a polynomial with real coefficients  $a_i, 1 \leq i \leq n$  and*

$$\Delta_1 = |a_1|, \quad \Delta_2 = \begin{vmatrix} a_1 & 1 \\ a_3 & a_2 \end{vmatrix}, \dots, \Delta_n = \begin{vmatrix} a_1 & 1 & 0 & \dots & 0 \\ a_3 & a_2 & a_1 & 0 & \dots & 0 \\ a_5 & a_4 & a_3 & a_2 & a_1 & 0 & \dots & 0 \\ \dots & \dots & \dots & \dots & \dots & \dots & \dots & \dots \\ 0 & \dots & \dots & \dots & \dots & \dots & \dots & a_n \end{vmatrix}.$$

Then  $Re\lambda < 0$  for all roots  $\lambda$  of  $P(\lambda)$  if and only if  $\Delta_i > 0$  for integers  $1 \leq i \leq n$ .

Thus, we get the following result by Theorem 2.22 and lemma 2.23.

**Corollary 2.24** *Let  $\Delta_1^v, \Delta_2^v, \dots, \Delta_n^v$  be the associated determinants with characteristic polynomials determined in Lemma 4.8 for  $\forall v \in V(G[LDES_m^1])$  or  $V(G[LDE_m^n])$ . Then for a spanning subgraph  $H < G[LDES_m^1]$  or  $G[LDE_m^n]$ , the zero  $G$ -solutions of  $(LDES_m^1)$  and  $(LDE_m^n)$  is asymptotically sum-stable on  $H$  if  $\Delta_1^v > 0, \Delta_2^v > 0, \dots, \Delta_n^v > 0$  for  $\forall v \in V(H)$ .*

Particularly, if  $n = 2$ , we are easily knowing that  $Re\lambda < 0$  for all roots  $\lambda$  of  $P(\lambda)$  if and only if  $a_1 > 0$  and  $a_2 > 0$  by Lemma 2.23. We get the following result.

**Corollary 2.25** *Let  $H < G[LDES_m^1]$  or  $G[LDE_m^n]$  be a spanning subgraph. If the characteristic polynomials are  $\lambda^2 + a_1^v\lambda + a_2^v$  for  $v \in V(H)$  in  $(LDES_m^1)$  (or  $(LDE_m^2)$ ), then the zero  $G$ -solutions of  $(LDES_m^1)$  and  $(LDE_m^2)$  is asymptotically sum-stable on  $H$  if  $a_1^v > 0, a_2^v > 0$  for  $\forall v \in V(H)$ .*

### 2.3.2 Prod-Stability

**Definition 2.26** *Let  $H$  be a spanning subgraph of  $G[LDES_m^1]$  or  $G[LDE_m^n]$  of the linear homogeneous differential equation systems  $(LDES_m^1)$  with initial value  $X_v(0)$  or  $(LDE_m^n)$  with initial values  $x_v(0), x'_v(0), \dots, x_v^{(n-1)}(0)$ . Then  $G[LDES_m^1]$  or  $G[LDE_m^n]$  is called prod-stable or asymptotically prod-stable on  $H$  if for all solutions  $Y_v(t), v \in V(H)$  of the linear differential equations of  $(LDES_m^1)$  or  $(LDE_m^n)$  with  $|Y_v(0) - X_v(0)| < \delta_v$  exists for all  $t \geq 0, | \prod_{v \in V(H)} Y_v(t) - \prod_{v \in V(H)} X_v(t) | < \varepsilon$ , or furthermore,  $\lim_{t \rightarrow 0} | \prod_{v \in V(H)} Y_v(t) - \prod_{v \in V(H)} X_v(t) | = 0$ .*

We know the following result on the prod-stability of linear differential equation system  $(LDES_m^1)$  and  $(LDE_m^n)$ .

**Theorem 2.27** *A zero  $G$ -solution of linear homogenous differential equation systems ( $LDES_m^1$ ) (or ( $LDE_m^n$ )) is asymptotically prod-stable on a spanning subgraph  $H$  of  $G[LDES_m^1]$  (or  $G[LDE_m^n]$ ) if and only if  $\sum_{v \in V(H)} \text{Re}\alpha_v < 0$  for each  $\bar{\beta}_v(t)e^{\alpha_v t} \in \mathcal{B}_v$  in ( $LDES^1$ ) or  $\sum_{v \in V(H)} \text{Re}\lambda_v < 0$  for each  $t^{l_v}e^{\lambda_v t} \in \mathcal{C}_v$  in ( $LDE_m^n$ ).*

*Proof* Applying Theorem 1.2, we know that a solution  $X_v(t)$  at the vertex  $v$  has the form

$$X_v(t) = \sum_{i=1}^n c_i \bar{\beta}_v(t) e^{\alpha_v t}.$$

Whence,

$$\begin{aligned} \left| \prod_{v \in V(H)} X_v(t) \right| &= \left| \prod_{v \in V(H)} \sum_{i=1}^n c_i \bar{\beta}_v(t) e^{\alpha_v t} \right| \\ &= \left| \sum_{i=1}^n \prod_{v \in V(H)} c_i \bar{\beta}_v(t) e^{\alpha_v t} \right| = \left| \sum_{i=1}^n \prod_{v \in V(H)} c_i \bar{\beta}_v(t) \right| e^{\sum_{v \in V(H)} \alpha_v t}. \end{aligned}$$

Whence, the zero  $G$ -solution of homogenous ( $LDES_m^1$ ) (or ( $LDE_m^n$ )) is asymptotically sum-stable on subgraph  $H$  if and only if  $\sum_{v \in V(H)} \text{Re}\alpha_v < 0$  for  $\forall \bar{\beta}_v(t)e^{\alpha_v t} \in \mathcal{B}_v$  in ( $LDES^1$ ) or  $\sum_{v \in V(H)} \text{Re}\lambda_v < 0$  for  $\forall t^{l_v}e^{\lambda_v t} \in \mathcal{C}_v$  in ( $LDE_m^n$ ).  $\square$

Applying Theorem 2.22, the following conclusion is a corollary of Theorem 2.27.

**Corollary 2.28** *A zero  $G$ -solution of linear homogenous differential equation systems ( $LDES_m^1$ ) (or ( $LDE_m^n$ )) is asymptotically prod-stable if it is asymptotically sum-stable on a spanning subgraph  $H$  of  $G[LDES_m^1]$  (or  $G[LDE_m^n]$ ). Particularly, it is asymptotically prod-stable if the zero solution  $\bar{0}$  is stable on  $\forall v \in V(H)$ .*

**Example 2.29** Let a  $G$ -solution of ( $LDES_m^1$ ) or ( $LDE_m^n$ ) be the basis graph shown in Fig.5, where  $v_1 = \{e^{-2t}, e^{-3t}, e^{3t}\}$ ,  $v_2 = \{e^{-3t}, e^{-4t}\}$ ,  $v_3 = \{e^{-4t}, e^{-5t}, e^{3t}\}$ ,  $v_4 = \{e^{-5t}, e^{-6t}, e^{-8t}\}$ ,  $v_5 = \{e^{-t}, e^{-6t}\}$ ,  $v_6 = \{e^{-t}, e^{-2t}, e^{-8t}\}$ . Then the zero  $G$ -solution is sum-stable on the triangle  $v_4v_5v_6$ , but it is not on the triangle  $v_1v_2v_3$ . In fact, it is prod-stable on the triangle  $v_1v_2v_3$ .

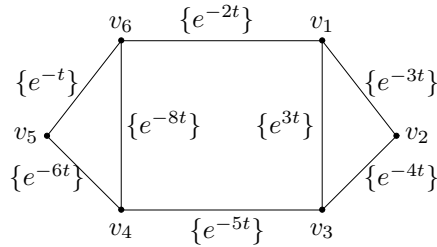

**Fig.5 A basis graph**

### §3. Global Stability of Non-Solvable Non-Linear Differential Equations

For differential equation system  $(DES_m^1)$ , we consider the stability of its zero  $G$ -solution of linearized differential equation system  $(LDES_m^1)$  in this section.

#### 3.1 Global Stability of Non-Solvable Differential Equations

**Definition 3.1** Let  $H$  be a spanning subgraph of  $G[DES_m^1]$  of the linearized differential equation systems  $(DES_m^1)$  with initial value  $X_v(0)$ . A point  $X^* \in \mathbf{R}^n$  is called a  $H$ -equilibrium point of differential equation system  $(DES_m^1)$  if  $f_v(X^*) = \bar{0}$  for  $\forall v \in V(H)$ .

Clearly,  $\bar{0}$  is a  $H$ -equilibrium point for any spanning subgraph  $H$  of  $G[DES_m^1]$  by definition. Whence, its zero  $G$ -solution of linearized differential equation system  $(LDES_m^1)$  is a solution of  $(DES_m^1)$ .

**Definition 3.2** Let  $H$  be a spanning subgraph of  $G[DES_m^1]$  of the linearized differential equation systems  $(DES_m^1)$  with initial value  $X_v(0)$ . Then  $G[DES_m^1]$  is called *sum-stable* or *asymptotically sum-stable* on  $H$  if for all solutions  $Y_v(t)$ ,  $v \in V(H)$  of  $(DES_m^1)$  with  $\|Y_v(0) - X_v(0)\| < \delta_v$  exists for all  $t \geq 0$ ,

$$\left\| \sum_{v \in V(H)} Y_v(t) - \sum_{v \in V(H)} X_v(t) \right\| < \varepsilon,$$

or furthermore,

$$\lim_{t \rightarrow 0} \left\| \sum_{v \in V(H)} Y_v(t) - \sum_{v \in V(H)} X_v(t) \right\| = 0,$$

and *prod-stable* or *asymptotically prod-stable* on  $H$  if for all solutions  $Y_v(t)$ ,  $v \in V(H)$  of  $(DES_m^1)$  with  $\|Y_v(0) - X_v(0)\| < \delta_v$  exists for all  $t \geq 0$ ,

$$\left\| \prod_{v \in V(H)} Y_v(t) - \prod_{v \in V(H)} X_v(t) \right\| < \varepsilon,$$

or furthermore,

$$\lim_{t \rightarrow 0} \left\| \prod_{v \in V(H)} Y_v(t) - \prod_{v \in V(H)} X_v(t) \right\| = 0.$$

Clearly, the asymptotically sum-stability or prod-stability implies respectively that the sum-stability or prod-stability.

Then we get the following result on the sum-stability and prod-stability of the zero  $G$ -solution of  $(DES_m^1)$ .

**Theorem 3.3** For a  $G$ -solution  $G[DES_m^1]$  of differential equation systems  $(DES_m^1)$  with initial value  $X_v(0)$ , let  $H_1, H_2$  be spanning subgraphs of  $G[DES_m^1]$ . If the zero  $G$ -solution of  $(DES_m^1)$

is sum-stable or asymptotically sum-stable on  $H_1$  and  $H_2$ , then the zero  $G$ -solution of  $(DES_m^1)$  is sum-stable or asymptotically sum-stable on  $H_1 \cup H_2$ .

Similarly, if the zero  $G$ -solution of  $(DES_m^1)$  is prod-stable or asymptotically prod-stable on  $H_1$  and  $X_v(t)$  is bounded for  $\forall v \in V(H_2)$ , then the zero  $G$ -solution of  $(DES_m^1)$  is prod-stable or asymptotically prod-stable on  $H_1 \cup H_2$ .

*Proof* Notice that

$$\|X_1 + X_2\| \leq \|X_1\| + \|X_2\| \quad \text{and} \quad \|X_1 X_2\| \leq \|X_1\| \|X_2\|$$

in  $\mathbf{R}^n$ . We know that

$$\begin{aligned} \left\| \sum_{v \in V(H_1) \cup V(H_2)} X_v(t) \right\| &= \left\| \sum_{v \in V(H_1)} X_v(t) + \sum_{v \in V(H_2)} X_v(t) \right\| \\ &\leq \left\| \sum_{v \in V(H_1)} X_v(t) \right\| + \left\| \sum_{v \in V(H_2)} X_v(t) \right\| \end{aligned}$$

and

$$\begin{aligned} \left\| \prod_{v \in V(H_1) \cup V(H_2)} X_v(t) \right\| &= \left\| \prod_{v \in V(H_1)} X_v(t) \prod_{v \in V(H_2)} X_v(t) \right\| \\ &\leq \left\| \prod_{v \in V(H_1)} X_v(t) \right\| \left\| \prod_{v \in V(H_2)} X_v(t) \right\|. \end{aligned}$$

Whence,

$$\left\| \sum_{v \in V(H_1) \cup V(H_2)} X_v(t) \right\| \leq \epsilon \quad \text{or} \quad \lim_{t \rightarrow 0} \left\| \sum_{v \in V(H_1) \cup V(H_2)} X_v(t) \right\| = 0$$

if  $\epsilon = \epsilon_1 + \epsilon_2$  with

$$\left\| \sum_{v \in V(H_1)} X_v(t) \right\| \leq \epsilon_1 \quad \text{and} \quad \left\| \sum_{v \in V(H_2)} X_v(t) \right\| \leq \epsilon_2$$

or

$$\lim_{t \rightarrow 0} \left\| \sum_{v \in V(H_1)} X_v(t) \right\| = 0 \quad \text{and} \quad \lim_{t \rightarrow 0} \left\| \sum_{v \in V(H_2)} X_v(t) \right\| = 0.$$

This is the conclusion (1). For the conclusion (2), notice that

$$\left\| \prod_{v \in V(H_1) \cup V(H_2)} X_v(t) \right\| \leq \left\| \prod_{v \in V(H_1)} X_v(t) \right\| \left\| \prod_{v \in V(H_2)} X_v(t) \right\| \leq M\epsilon$$

if

$$\left\| \prod_{v \in V(H_1)} X_v(t) \right\| \leq \epsilon \quad \text{and} \quad \left\| \prod_{v \in V(H_2)} X_v(t) \right\| \leq M.$$

Consequently, the zero  $G$ -solution of  $(DES_m^1)$  is prod-stable or asymptotically prod-stable on  $H_1 \cup H_2$ .  $\square$

Theorem 3.3 enables one to get the following conclusion which establishes the relation of stability of differential equations at vertices with that of sum-stability and prod-stability.

**Corollary 3.4** *For a  $G$ -solution  $G[DES_m^1]$  of differential equation system  $(DES_m^1)$  with initial value  $X_v(0)$ , let  $H$  be a spanning subgraph of  $G[DES_m^1]$ . If the zero solution is stable or asymptotically stable at each vertex  $v \in V(H)$ , then it is sum-stable, or asymptotically sum-stable and if the zero solution is stable or asymptotically stable in a vertex  $u \in V(H)$  and  $X_v(t)$  is bounded for  $\forall v \in V(H) \setminus \{u\}$ , then it is prod-stable, or asymptotically prod-stable on  $H$ .*

It should be noted that the converse of Theorem 3.3 is not always true. For example, let

$$\left\| \sum_{v \in V(H_1)} X_v(t) \right\| \leq a + \epsilon \quad \text{and} \quad \left\| \sum_{v \in V(H_2)} X_v(t) \right\| \leq -a + \epsilon.$$

Then the zero  $G$ -solution  $G[DES_m^1]$  of differential equation system  $(DES_m^1)$  is not sum-stable on subgraphs  $H_1$  and  $H_2$ , but

$$\left\| \sum_{v \in V(H_1 \cup H_2)} X_v(t) \right\| \leq \left\| \sum_{v \in V(H_1)} X_v(t) \right\| + \left\| \sum_{v \in V(H_2)} X_v(t) \right\| = \epsilon.$$

Thus the zero  $G$ -solution  $G[DES_m^1]$  of differential equation system  $(DES_m^1)$  is sum-stable on subgraphs  $H_1 \cup H_2$ . Similarly, let

$$\left\| \prod_{v \in V(H_1)} X_v(t) \right\| \leq \frac{\epsilon}{t^r} \quad \text{and} \quad \left\| \sum_{v \in V(H_2)} X_v(t) \right\| \leq t^r$$

for a real number  $r$ . Then the zero  $G$ -solution  $G[DES_m^1]$  of  $(DES_m^1)$  is not prod-stable on subgraphs  $H_1$  and  $X_v(t)$  is not bounded for  $v \in V(H_2)$  if  $r > 0$ . However, it is prod-stable on subgraphs  $H_1 \cup H_2$  for

$$\left\| \prod_{v \in V(H_1 \cup H_2)} X_v(t) \right\| \leq \left\| \prod_{v \in V(H_1)} X_v(t) \right\| \left\| \prod_{v \in V(H_2)} X_v(t) \right\| = \epsilon.$$

### 3.2 Linearized Differential Equations

Applying these conclusions on linear differential equation systems in the previous section, we

can find conditions on  $F_i(X)$ ,  $1 \leq i \leq m$  for the sum-stability and prod-stability at  $\bar{0}$  following. For this objective, we need the following useful result.

**Lemma 3.5**([13]) *Let  $\dot{X} = AX + B(X)$  be a non-linear differential equation, where  $A$  is a constant  $n \times n$  matrix and  $\text{Re}\lambda_i < 0$  for all eigenvalues  $\lambda_i$  of  $A$  and  $B(X)$  is continuous defined on  $t \geq 0$ ,  $\|X\| \leq \alpha$  with*

$$\lim_{\|X\| \rightarrow 0} \frac{\|B(X)\|}{\|X\|} = 0.$$

*Then there exist constants  $c > 0$ ,  $\beta > 0$  and  $\delta$ ,  $0 < \delta < \alpha$  such that*

$$\|X(0)\| \leq \varepsilon \leq \frac{\delta}{2c} \text{ implies that } \|X(t)\| \leq c\varepsilon e^{-\beta t/2}.$$

**Theorem 3.6** *Let  $(DES_m^1)$  be a non-linear differential equation system,  $H$  a spanning subgraph of  $G[DES_m^1]$  and*

$$F_v(X) = F'_v(\bar{0})X + R_v(X)$$

*such that*

$$\lim_{\|X\| \rightarrow \bar{0}} \frac{\|R_v(X)\|}{\|X\|} = 0$$

*for  $\forall v \in V(H)$ . Then the zero  $G$ -solution of  $(DES_m^1)$  is asymptotically sum-stable or asymptotically prod-stable on  $H$  if  $\text{Re}\alpha_v < 0$  for each  $\bar{\beta}_v(t)e^{\alpha_v t} \in \mathcal{B}_v$ ,  $v \in V(H)$  in  $(DES_m^1)$ .*

*Proof* Define  $c = \max\{c_v, v \in V(H)\}$ ,  $\varepsilon = \min\{\varepsilon_v, v \in V(H)\}$  and  $\beta = \min\{\beta_v, v \in V(H)\}$ . Applying Lemma 3.5, we know that for  $\forall v \in V(H)$ ,

$$\|X_v(0)\| \leq \varepsilon \leq \frac{\delta}{2c}$$

implies that

$$\|X_v(t)\| \leq c\varepsilon e^{-\beta t/2}.$$

Whence,

$$\left\| \sum_{v \in V(H)} X_v(t) \right\| \leq \sum_{v \in V(H)} \|X_v(t)\| \leq |H|c\varepsilon e^{-\beta t/2}$$

$$\left\| \prod_{v \in V(H)} X_v(t) \right\| \leq \prod_{v \in V(H)} \|X_v(t)\| \leq c^{|H|}\varepsilon^{|H|}e^{-|H|\beta t/2}.$$

Consequently,

$$\lim_{t \rightarrow 0} \left\| \sum_{v \in V(H)} X_v(t) \right\| \rightarrow 0 \text{ and } \lim_{t \rightarrow 0} \left\| \prod_{v \in V(H)} X_v(t) \right\| \rightarrow 0.$$

Thus the zero  $G$ -solution  $(DES_m^n)$  is asymptotically sum-stable or asymptotically prod-stable on  $H$  by definition.  $\square$

### 3.3 Liapunov Functions on G-Solutions

We have know Liapunov functions associated with differential equations. Similarly, we introduce Liapunov functions for determining the sum-stability or prod-stability of  $(DES_m^1)$  following.

**Definition 3.7** Let  $(DES_m^1)$  be a differential equation system,  $H < G[DES_m^1]$  a spanning subgraph and a  $H$ -equilibrium point  $X^*$  of  $(DES_m^1)$ . A differentiable function  $L : \mathcal{O} \rightarrow \mathbf{R}$  defined on an open subset  $\mathcal{O} \subset \mathbf{R}^n$  is called a Liapunov sum-function on  $X^*$  for  $H$  if

$$(1) L(X^*) = 0 \text{ and } L \left( \sum_{v \in V(H)} X_v(t) \right) > 0 \text{ if } \sum_{v \in V(H)} X_v(t) \neq X^*;$$

$$(2) \dot{L} \left( \sum_{v \in V(H)} X_v(t) \right) \leq 0 \text{ for } \sum_{v \in V(H)} X_v(t) \neq X^*,$$

and a Liapunov prod-function on  $X^*$  for  $H$  if

$$(1) L(X^*) = 0 \text{ and } L \left( \prod_{v \in V(H)} X_v(t) \right) > 0 \text{ if } \prod_{v \in V(H)} X_v(t) \neq X^*;$$

$$(2) \dot{L} \left( \prod_{v \in V(H)} X_v(t) \right) \leq 0 \text{ for } \prod_{v \in V(H)} X_v(t) \neq X^*.$$

Then, the following conclusions on the sum-stable and prod-stable of zero  $G$ -solutions of differential equations holds.

**Theorem 3.8** For a  $G$ -solution  $G[DES_m^1]$  of a differential equation system  $(DES_m^1)$  with initial value  $X_v(0)$ , let  $H$  be a spanning subgraph of  $G[DES_m^1]$  and  $X^*$  an equilibrium point of  $(DES_m^1)$  on  $H$ .

(1) If there is a Liapunov sum-function  $L : \mathcal{O} \rightarrow \mathbf{R}$  on  $X^*$ , then the zero  $G$ -solution  $G[DES_m^1]$  is sum-stable on  $X^*$  for  $H$ . Furthermore, if

$$\dot{L} \left( \sum_{v \in V(H)} X_v(t) \right) < 0$$

for  $\sum_{v \in V(H)} X_v(t) \neq X^*$ , then the zero  $G$ -solution  $G[DES_m^1]$  is asymptotically sum-stable on  $X^*$  for  $H$ .

(2) If there is a Liapunov prod-function  $L : \mathcal{O} \rightarrow \mathbf{R}$  on  $X^*$  for  $H$ , then the zero  $G$ -solution  $G[DES_m^1]$  is prod-stable on  $X^*$  for  $H$ . Furthermore, if

$$\dot{L} \left( \prod_{v \in V(H)} X_v(t) \right) < 0$$

for  $\prod_{v \in V(H)} X_v(t) \neq X^*$ , then the zero  $G$ -solution  $G[DES_m^1]$  is asymptotically prod-stable on  $X^*$  for  $H$ .

*Proof* Let  $\epsilon > 0$  be a so small number that the closed ball  $B_\epsilon(X^*)$  centered at  $X^*$  with

radius  $\epsilon$  lies entirely in  $\mathcal{O}$  and  $\varpi$  the minimum value of  $L$  on the boundary of  $B_\epsilon(X^*)$ , i.e., the sphere  $S_\epsilon(X^*)$ . Clearly,  $\varpi > 0$  by assumption. Define  $U = \{X \in B_\epsilon(X^*) | L(X) < \varpi\}$ . Notice that  $X^* \in U$  and  $L$  is non-increasing on  $\sum_{v \in V(H)} X_v(t)$  by definition. Whence, there are no solutions  $X_v(t)$ ,  $v \in V(H)$  starting in  $U$  such that  $\sum_{v \in V(H)} X_v(t)$  meet the sphere  $S_\epsilon(X^*)$ . Thus all solutions  $X_v(t)$ ,  $v \in V(H)$  starting in  $U$  enable  $\sum_{v \in V(H)} X_v(t)$  included in ball  $B_\epsilon(X^*)$ . Consequently, the zero  $G$ -solution  $G[DES_m^1]$  is sum-stable on  $H$  by definition.

Now assume that

$$\dot{L} \left( \sum_{v \in V(H)} X_v(t) \right) < 0$$

for  $\sum_{v \in V(H)} X_v(t) \neq X^*$ . Thus  $L$  is strictly decreasing on  $\sum_{v \in V(H)} X_v(t)$ . If  $X_v(t)$ ,  $v \in V(H)$  are solutions starting in  $U - X^*$  such that  $\sum_{v \in V(H)} X_v(t_n) \rightarrow Y^*$  for  $n \rightarrow \infty$  with  $Y^* \in B_\epsilon(X^*)$ , then it must be  $Y^* = X^*$ . Otherwise, since

$$L \left( \sum_{v \in V(H)} X_v(t) \right) > L(Y^*)$$

by the assumption

$$\dot{L} \left( \sum_{v \in V(H)} X_v(t) \right) < 0$$

for all  $\sum_{v \in V(H)} X_v(t) \neq X^*$  and

$$L \left( \sum_{v \in V(H)} X_v(t_n) \right) \rightarrow L(Y^*)$$

by the continuity of  $L$ , if  $Y^* \neq X^*$ , let  $Y_v(t)$ ,  $v \in V(H)$  be the solutions starting at  $Y^*$ . Then for any  $\eta > 0$ ,

$$L \left( \sum_{v \in V(H)} Y_v(\eta) \right) < L(Y^*).$$

But then there is a contradiction

$$L \left( \sum_{v \in V(H)} X_v(t_n + \eta) \right) < L(Y^*)$$

yields by letting  $Y_v(0) = \sum_{v \in V(H)} X_v(t_n)$  for sufficiently large  $n$ . Thus, there must be  $Y_v^* = X^*$ .

Whence, the zero  $G$ -solution  $G[DES_m^1]$  is asymptotically sum-stable on  $H$  by definition. This is the conclusion (1).

Similarly, we can prove the conclusion (2).  $\square$



The following result shows the combination of Liapunov sum-functions or prod-functions.

**Theorem 3.9** For a  $G$ -solution  $G[DES_m^1]$  of a differential equation system  $(DES_m^1)$  with initial value  $X_v(0)$ , let  $H_1, H_2$  be spanning subgraphs of  $G[DES_m^1]$ ,  $X^*$  an equilibrium point of  $(DES_m^1)$  on  $H_1 \cup H_2$  and

$$R^+(x, y) = \sum_{i \geq 0, j \geq 0} a_{i,j} x^i y^j$$

be a polynomial with  $a_{i,j} \geq 0$  for integers  $i, j \geq 0$ . Then  $R^+(L_1, L_2)$  is a Liapunov sum-function or Liapunov prod-function on  $X^*$  for  $H_1 \cup H_2$  with conventions for integers  $i, j, k, l \geq 0$  that

$$\begin{aligned} & a_{ij} L_1^i L_2^j \left( \sum_{v \in V(H_1 \cup V(H_2))} X_v(t) \right) + a_{kl} L_1^k L_2^l \left( \sum_{v \in V(H_1 \cup V(H_2))} X_v(t) \right) \\ &= a_{ij} L_1^i \left( \sum_{v \in V(H_1)} X_v(t) \right) L_2^j \left( \sum_{v \in V(H_2)} X_v(t) \right) \\ &+ a_{kl} L_1^k \left( \sum_{v \in V(H_1)} X_v(t) \right) L_2^l \left( \sum_{v \in V(H_2)} X_v(t) \right) \end{aligned}$$

if  $L_1, L_2$  are Liapunov sum-functions and

$$\begin{aligned} & a_{ij} L_1^i L_2^j \left( \prod_{v \in V(H_1 \cup V(H_2))} X_v(t) \right) + a_{kl} L_1^k L_2^l \left( \prod_{v \in V(H_1 \cup V(H_2))} X_v(t) \right) \\ &= a_{ij} L_1^i \left( \prod_{v \in V(H_1)} X_v(t) \right) L_2^j \left( \prod_{v \in V(H_2)} X_v(t) \right) \\ &+ a_{kl} L_1^k \left( \prod_{v \in V(H_1)} X_v(t) \right) L_2^l \left( \prod_{v \in V(H_2)} X_v(t) \right) \end{aligned}$$

if  $L_1, L_2$  are Liapunov prod-functions on  $X^*$  for  $H_1$  and  $H_2$ , respectively. Particularly, if there is a Liapunov sum-function (Liapunov prod-function)  $L$  on  $H_1$  and  $H_2$ , then  $L$  is also a Liapunov sum-function (Liapunov prod-function) on  $H_1 \cup H_2$ .

*Proof* Notice that

$$\frac{d(a_{ij} L_1^i L_2^j)}{dt} = a_{ij} \left( i L_1^{i-1} \dot{L}_1 L_2^j + j L_1^i L_2^{j-1} \dot{L}_2 \right)$$

if  $i, j \geq 1$ . Whence,

$$a_{ij} L_1^i L_2^j \left( \sum_{v \in V(H_1 \cup V(H_2))} X_v(t) \right) \geq 0$$

if

$$L_1 \left( \sum_{v \in V(H_1)} X_v(t) \right) \geq 0 \text{ and } L_2 \left( \sum_{v \in V(H_2)} X_v(t) \right) \geq 0$$

and

$$\frac{d(a_{ij}L_1^iL_2^j)}{dt} \left( \sum_{v \in V(H_1 \cup V(H_2))} X_v(t) \right) \leq 0$$

if

$$\dot{L}_1 \left( \sum_{v \in V(H_1)} X_v(t) \right) \leq 0 \text{ and } \dot{L}_2 \left( \sum_{v \in V(H_2)} X_v(t) \right) \leq 0.$$

Thus  $R^+(L_1, L_2)$  is a Liapunov sum-function on  $X^*$  for  $H_1 \cup H_2$ .

Similarly, we can know that  $R^+(L_1, L_2)$  is a Liapunov prod-function on  $X^*$  for  $H_1 \cup H_2$  if  $L_1, L_2$  are Liapunov prod-functions on  $X^*$  for  $H_1$  and  $H_2$ .  $\square$

Theorem 3.9 enables one easily to get the stability of the zero  $G$ -solutions of  $(DES_m^1)$ .

**Corollary 3.10** For a differential equation system  $(DES_m^1)$ , let  $H < G[DES_m^1]$  be a spanning subgraph. If  $L_v$  is a Liapunov function on vertex  $v$  for  $\forall v \in V(H)$ , then the functions

$$L_S^H = \sum_{v \in V(H)} L_v \text{ and } L_P^H = \prod_{v \in V(H)} L_v$$

are respectively Liapunov sum-function and Liapunov prod-function on graph  $H$ . Particularly, if  $L = L_v$  for  $\forall v \in V(H)$ , then  $L$  is both a Liapunov sum-function and a Liapunov prod-function on  $H$ .

**Example 3.11** Let  $(DES_m^1)$  be determined by

$$\begin{cases} dx_1/dt = \lambda_{11}x_1 \\ dx_2/dt = \lambda_{12}x_2 \\ \dots\dots\dots \\ dx_n/dt = \lambda_{1n}x_n \end{cases} \begin{cases} dx_1/dt = \lambda_{21}x_1 \\ dx_2/dt = \lambda_{22}x_2 \\ \dots\dots\dots \\ dx_n/dt = \lambda_{2n}x_n \end{cases} \dots \begin{cases} dx_1/dt = \lambda_{n1}x_1 \\ dx_2/dt = \lambda_{n2}x_2 \\ \dots\dots\dots \\ dx_n/dt = \lambda_{nn}x_n \end{cases}$$

where all  $\lambda_{ij}$ ,  $1 \leq i \leq m, 1 \leq j \leq n$  are real and  $\lambda_{ij_1} \neq \lambda_{ij_2}$  if  $j_1 \neq j_2$  for integers  $1 \leq i \leq m$ . Let  $L = x_1^2 + x_2^2 + \dots + x_n^2$ . Then

$$\dot{L} = \lambda_{i1}x_1^2 + \lambda_{i2}x_2^2 + \dots + \lambda_{in}x_n^2$$

for integers  $1 \leq i \leq n$ . Whence, it is a Liapunov function for the  $i$ th differential equation if  $\lambda_{ij} < 0$  for integers  $1 \leq j \leq n$ . Now let  $H < G[LDES_m^1]$  be a spanning subgraph of  $G[LDES_m^1]$ . Then  $L$  is both a Liapunov sum-function and a Liapunov prod-function on  $H$  if  $\lambda_{vj} < 0$  for  $\forall v \in V(H)$  by Corollaries 3.10.

**Theorem 3.12** Let  $L : \mathcal{O} \rightarrow \mathbf{R}$  be a differentiable function with  $L(\bar{0}) = 0$  and  $L\left(\sum_{v \in V(H)} X\right) > 0$  always holds in an area of its  $\epsilon$ -neighborhood  $U(\epsilon)$  of  $\bar{0}$  for  $\epsilon > 0$ , denoted by  $U^+(\bar{0}, \epsilon)$  such area of  $\epsilon$ -neighborhood of  $\bar{0}$  with  $L\left(\sum_{v \in V(H)} X\right) > 0$  and  $H < G[DES_m^1]$  be a spanning subgraph.

(1) If

$$\left\| L\left(\sum_{v \in V(H)} X\right) \right\| \leq M$$

with  $M$  a positive number and

$$\dot{L}\left(\sum_{v \in V(H)} X\right) > 0$$

in  $U^+(\bar{0}, \epsilon)$ , and for  $\forall \epsilon > 0$ , there exists a positive number  $c_1, c_2$  such that

$$L\left(\sum_{v \in V(H)} X\right) \geq c_1 > 0 \text{ implies } \dot{L}\left(\sum_{v \in V(H)} X\right) \geq c_2 > 0,$$

then the zero  $G$ -solution  $G[DES_m^1]$  is not sum-stable on  $H$ . Such a function  $L : \mathcal{O} \rightarrow \mathbf{R}$  is called a non-Liapunov sum-function on  $H$ .

(2) If

$$\left\| L\left(\prod_{v \in V(H)} X\right) \right\| \leq N$$

with  $N$  a positive number and

$$\dot{L}\left(\prod_{v \in V(H)} X\right) > 0$$

in  $U^+(\bar{0}, \epsilon)$ , and for  $\forall \epsilon > 0$ , there exists positive numbers  $d_1, d_2$  such that

$$L\left(\prod_{v \in V(H)} X\right) \geq d_1 > 0 \text{ implies } \dot{L}\left(\prod_{v \in V(H)} X\right) \geq d_2 > 0,$$

then the zero  $G$ -solution  $G[DES_m^1]$  is not prod-stable on  $H$ . Such a function  $L : \mathcal{O} \rightarrow \mathbf{R}$  is called a non-Liapunov prod-function on  $H$ .

*Proof* Generally, if  $\|L(X)\|$  is bounded and  $\dot{L}(X) > 0$  in  $U^+(\bar{0}, \epsilon)$ , and for  $\forall \epsilon > 0$ , there exists positive numbers  $c_1, c_2$  such that if  $L(X) \geq c_1 > 0$ , then  $\dot{L}(X) \geq c_2 > 0$ , we prove that there exists  $t_1 > t_0$  such that  $\|X(t_1, t_0)\| > \epsilon_0$  for a number  $\epsilon_0 > 0$ , where  $X(t_1, t_0)$  denotes the solution of  $(DES_m^n)$  passing through  $X(t_0)$ . Otherwise, there must be  $\|X(t_1, t_0)\| < \epsilon_0$  for  $t \geq t_0$ . By  $\dot{L}(X) > 0$  we know that  $L(X(t)) > L(X(t_0)) > 0$  for  $t \geq t_0$ . Combining this fact

with the condition  $\dot{L}(X) \geq c_2 > 0$ , we get that

$$L(X(t)) = L(X(t_0)) + \int_{t_0}^t \frac{dL(X(s))}{ds} \geq L(X(t_0)) + c_2(t - t_0).$$

Thus  $L(X(t)) \rightarrow +\infty$  if  $t \rightarrow +\infty$ , a contradiction to the assumption that  $L(X)$  is bounded. Whence, there exists  $t_1 > t_0$  such that

$$\|X(t_1, t_0)\| > \epsilon_0.$$

Applying this conclusion, we immediately know that the zero  $G$ -solution  $G[DES_m^1]$  is not sum-stable or prod-stable on  $H$  by conditions in (1) or (2).  $\square$

Similar to Theorem 3.9, we know results for non-Liapunov sum-function or prod-function by Theorem 3.12 following.

**Theorem 3.13** *For a  $G$ -solution  $G[DES_m^1]$  of a differential equation system  $(DES_m^1)$  with initial value  $X_v(0)$ , let  $H_1, H_2$  be spanning subgraphs of  $G[DES_m^1]$ ,  $\bar{0}$  an equilibrium point of  $(DES_m^1)$  on  $H_1 \cup H_2$ . Then  $R^+(L_1, L_2)$  is a non-Liapunov sum-function or non-Liapunov prod-function on  $\bar{0}$  for  $H_1 \cup H_2$  with conventions for*

$$a_{ij}L_1^iL_2^j \left( \sum_{v \in V(H_1 \cup V(H_2))} X_v(t) \right) + a_{kl}L_1^kL_2^l \left( \sum_{v \in V(H_1 \cup V(H_2))} X_v(t) \right)$$

and

$$a_{ij}L_1^iL_2^j \left( \prod_{v \in V(H_1 \cup V(H_2))} X_v(t) \right) + a_{kl}L_1^kL_2^l \left( \prod_{v \in V(H_1 \cup V(H_2))} X_v(t) \right)$$

the same as in Theorem 3.9 if  $L_1, L_2$  are non-Liapunov sum-functions or non-Liapunov prod-functions on  $\bar{0}$  for  $H_1$  and  $H_2$ , respectively. Particularly, if there is a non-Liapunov sum-function (non-Liapunov prod-function)  $L$  on  $H_1$  and  $H_2$ , then  $L$  is also a non-Liapunov sum-function (non-Liapunov prod-function) on  $H_1 \cup H_2$ .

*Proof* Similarly, we can show that  $R^+(L_1, L_2)$  satisfies these conditions on  $H_1 \cup H_2$  for non-Liapunov sum-functions or non-Liapunov prod-functions in Theorem 3.12 if  $L_1, L_2$  are non-Liapunov sum-functions or non-Liapunov prod-functions on  $\bar{0}$  for  $H_1$  and  $H_2$ , respectively. Thus  $R^+(L_1, L_2)$  is a non-Liapunov sum-function or non-Liapunov prod-function on  $\bar{0}$ .  $\square$

**Corollary 3.14** *For a differential equation system  $(DES_m^1)$ , let  $H < G[DES_m^1]$  be a spanning subgraph. If  $L_v$  is a non-Liapunov function on vertex  $v$  for  $\forall v \in V(H)$ , then the functions*

$$L_S^H = \sum_{v \in V(H)} L_v \quad \text{and} \quad L_P^H = \prod_{v \in V(H)} L_v$$

are respectively non-Liapunov sum-function and non-Liapunov prod-function on graph  $H$ . Par-



$$V(G[SDES_m^1]) = \{\mathcal{B}_i | 1 \leq i \leq m\},$$

$$E(G[SDES_m^1]) = \{(\mathcal{B}_i, \mathcal{B}_j) | \mathcal{B}_i \cap \mathcal{B}_j \neq \emptyset, 1 \leq i, j \leq m\},$$

where  $\mathcal{B}_i$  is the solution basis of the  $i$ -th linearized differential equation  $\dot{X}_i = F'_i(\bar{0})X_i$  for integers  $1 \leq i \leq m$ , called such a vertex-edge labeled graph  $G[SDES_m^1]$  the  $G$ -solution of  $(SDES_m^1)$  and its zero  $G$ -solution replaced  $\mathcal{B}_i$  by  $(0, \dots, 0)$  ( $|\mathcal{B}_i|$  times) and  $\mathcal{B}_i \cap \mathcal{B}_j$  by  $(0, \dots, 0)$  ( $|\mathcal{B}_i \cap \mathcal{B}_j|$  times) for integers  $1 \leq i, j \leq m$ .

Let  $(LDES_m^1), (LDES_m^1)'$  be linearized differential equation systems of shifted differential equation systems  $(SDES_m^1)$  and  $(SDES_m^1)'$  with  $G$ -solutions  $H, H'$ . Similarly, they are called combinatorially equivalent if there is an isomorphism  $\varphi : H \rightarrow H'$  of graph and labelings  $\theta, \tau$  on  $H$  and  $H'$  respectively such that  $\varphi\theta(x) = \tau\varphi(x)$  for  $\forall x \in V(H) \cup E(H)$ , denoted by  $(SDES_m^1) \stackrel{\cong}{\sim} (SDES_m^1)'$ . Notice that if we remove these superfluous variables from  $G[SDES_m^1]$ , then we get nothing but the same vertex-edge labeled graph of  $(LDES_m^1)$  in  $\mathbf{R}^l$ . Thus we can classify shifted differential similarly to  $(LDES_m^1)$  in  $\mathbf{R}^l$ . The following result can be proved similarly to Theorem 2.14.

**Theorem 4.2** *Let  $(LDES_m^1), (LDES_m^1)'$  be linearized differential equation systems of two shifted differential equation systems  $(SDES_m^1), (SDES_m^1)'$  with integral labeled graphs  $H, H'$ . Then  $(SDES_m^1) \stackrel{\cong}{\sim} (SDES_m^1)'$  if and only if  $H = H'$ .*

The stability of these shifted differential equation systems  $(SDES_m^1)$  is also similarly to that of  $(DES_m^1)$ . For example, we know the results on the stability of  $(SDES_m^1)$  similar to Theorems 2.22, 2.27 and 3.6 following.

**Theorem 4.3** *Let  $(LDES_m^1)$  be a shifted linear differential equation systems and  $H < G[LDES_m^1]$  a spanning subgraph. A zero  $G$ -solution of  $(LDES_m^1)$  is asymptotically sum-stable on  $H$  if and only if  $\text{Re}\alpha_v < 0$  for each  $\bar{\beta}_v(t)e^{\alpha_v t} \in \mathcal{B}_v$  in  $(LDES^1)$  hold for  $\forall v \in V(H)$  and it is asymptotically prod-stable on  $H$  if and only if  $\sum_{v \in V(H)} \text{Re}\alpha_v < 0$  for each  $\bar{\beta}_v(t)e^{\alpha_v t} \in \mathcal{B}_v$  in  $(LDES^1)$ .*

**Theorem 4.4** *Let  $(SDES_m^1)$  be a shifted differential equation system,  $H < G[SDES_m^1]$  a spanning subgraph and*

$$F_v(X) = F'_v(\bar{0})X + R_v(X)$$

such that

$$\lim_{\|X\| \rightarrow \bar{0}} \frac{\|R_v(X)\|}{\|X\|} = 0$$

for  $\forall v \in V(H)$ . Then the zero  $G$ -solution of  $(SDES_m^1)$  is asymptotically sum-stable or asymptotically prod-stable on  $H$  if  $\text{Re}\alpha_v < 0$  for each  $\bar{\beta}_v(t)e^{\alpha_v t} \in \mathcal{B}_v, v \in V(H)$  in  $(SDES_m^1)$ .

For the Liapunov sum-function or Liapunov prod-function of a shifted differential equation system  $(SDES_m^1)$ , we choose it to be a differentiable function  $L : \mathcal{O} \subset \mathbf{R}^{\dim(SDES_m^1)} \rightarrow \mathbf{R}$  with conditions in Definition 3.7 hold. Then we know the following result similar to Theorem 3.8.

**Theorem 4.5** *For a  $G$ -solution  $G[SDES_m^1]$  of a shifted differential equation system  $(SDES_m^1)$  with initial value  $X_v(0)$ , let  $H$  be a spanning subgraph of  $G[DES_m^1]$  and  $X^*$  an equilibrium*

point of  $(SDES_m^1)$  on  $H$ .

(1) If there is a Liapunov sum-function  $L : \mathcal{O} \subset \mathbf{R}^{\dim(SDES_m^1)} \rightarrow \mathbf{R}$  on  $X^*$ , then the zero  $G$ -solution  $G[SDES_m^1]$  is sum-stable on  $X^*$  for  $H$ , and furthermore, if

$$\dot{L} \left( \sum_{v \in V(H)} X_v(t) \right) < 0$$

for  $\sum_{v \in V(H)} X_v(t) \neq X^*$ , then the zero  $G$ -solution  $G[SDES_m^1]$  is asymptotically sum-stable on  $X^*$  for  $H$ .

(2) If there is a Liapunov prod-function  $L : \mathcal{O} \subset \mathbf{R}^{\dim(SDES_m^1)} \rightarrow \mathbf{R}$  on  $X^*$  for  $H$ , then the zero  $G$ -solution  $G[SDES_m^1]$  is prod-stable on  $X^*$  for  $H$ , and furthermore, if

$$\dot{L} \left( \prod_{v \in V(H)} X_v(t) \right) < 0$$

for  $\prod_{v \in V(H)} X_v(t) \neq X^*$ , then the zero  $G$ -solution  $G[SDES_m^1]$  is asymptotically prod-stable on  $X^*$  for  $H$ .

## §5. Applications

### 5.1 Global Control of Infectious Diseases

An immediate application of non-solvable differential equations is the globally control of infectious diseases with more than one infectious virus in an area. Assume that there are three kind groups in persons at time  $t$ , i.e., infected  $I(t)$ , susceptible  $S(t)$  and recovered  $R(t)$ , and the total population is constant in that area. We consider two cases of virus for infectious diseases:

**Case 1** There are  $m$  known virus  $\mathcal{V}_1, \mathcal{V}_2, \dots, \mathcal{V}_m$  with infected rate  $k_i$ , heal rate  $h_i$  for integers  $1 \leq i \leq m$  and an person infected a virus  $\mathcal{V}_i$  will never infects other viruses  $\mathcal{V}_j$  for  $j \neq i$ .

**Case 2** There are  $m$  varying  $\mathcal{V}_1, \mathcal{V}_2, \dots, \mathcal{V}_m$  from a virus  $\mathcal{V}$  with infected rate  $k_i$ , heal rate  $h_i$  for integers  $1 \leq i \leq m$  such as those shown in Fig.6.

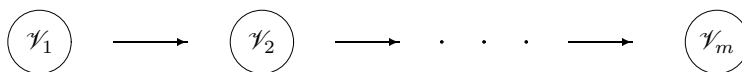

Fig.6

We are easily to establish a non-solvable differential model for the spread of infectious

viruses by applying the SIR model of one infectious disease following:

$$\left\{ \begin{array}{l} \dot{S} = -k_1SI \\ \dot{I} = k_1SI - h_1I \\ \dot{R} = h_1I \end{array} \right. \quad \left\{ \begin{array}{l} \dot{S} = -k_2SI \\ \dot{I} = k_2SI - h_2I \\ \dot{R} = h_2I \end{array} \right. \quad \cdots \quad \left\{ \begin{array}{l} \dot{S} = -k_mSI \\ \dot{I} = k_mSI - h_mI \\ \dot{R} = h_mI \end{array} \right. \quad (DES_m^1)$$

Notice that the total population is constant by assumption, i.e.,  $S + I + R$  is constant. Thus we only need to consider the following simplified system

$$\left\{ \begin{array}{l} \dot{S} = -k_1SI \\ \dot{I} = k_1SI - h_1I \end{array} \right. \quad \left\{ \begin{array}{l} \dot{S} = -k_2SI \\ \dot{I} = k_2SI - h_2I \end{array} \right. \quad \cdots \quad \left\{ \begin{array}{l} \dot{S} = -k_mSI \\ \dot{I} = k_mSI - h_mI \end{array} \right. \quad (DES_m^1)$$

The equilibrium points of this system are  $I = 0$ , the  $S$ -axis with linearization at equilibrium points

$$\left\{ \begin{array}{l} \dot{S} = -k_1S \\ \dot{I} = k_1S - h_1 \end{array} \right. \quad \left\{ \begin{array}{l} \dot{S} = -k_2S \\ \dot{I} = k_2S - h_2 \end{array} \right. \quad \cdots \quad \left\{ \begin{array}{l} \dot{S} = -k_mS \\ \dot{I} = k_mS - h_m \end{array} \right. \quad (LDES_m^1)$$

Calculation shows that the eigenvalues of the  $i$ th equation are 0 and  $k_iS - h_i$ , which is negative, i.e., stable if  $0 < S < h_i/k_i$  for integers  $1 \leq i \leq m$ . For any spanning subgraph  $H < G[LDES_m^1]$ , we know that its zero  $G$ -solution is asymptotically sum-stable on  $H$  if  $0 < S < h_v/k_v$  for  $v \in V(H)$  by Theorem 2.22, and it is asymptotically sum-stable on  $H$  if

$$\sum_{v \in V(H)} (k_v S - h_v) < 0 \quad \text{i.e.,} \quad 0 < S < \sum_{v \in V(H)} h_v / \sum_{v \in V(H)} k_v$$

by Theorem 2.27. Notice that if  $I_i(t)$ ,  $S_i(t)$  are probability functions for infectious viruses  $\mathcal{V}_i$ ,  $1 \leq i \leq m$  in an area, then  $\prod_{i=1}^m I_i(t)$  and  $\prod_{i=1}^m S_i(t)$  are just the probability functions for all these infectious viruses. This fact enables one to get the conclusion following for globally control of infectious diseases.

**Conclusion 5.1** For  $m$  infectious viruses  $\mathcal{V}_1, \mathcal{V}_2, \dots, \mathcal{V}_m$  in an area with infected rate  $k_i$ , heal rate  $h_i$  for integers  $1 \leq i \leq m$ , then they decline to 0 finally if

$$0 < S < \sum_{i=1}^m h_i / \sum_{i=1}^m k_i,$$

i.e., these infectious viruses are globally controlled. Particularly, they are globally controlled if each of them is controlled in this area.

## 5.2 Dynamical Equations of Instable Structure

There are two kind of engineering structures, i.e., stable and instable. An engineering structure



is *instable* if its state moving further away and the equilibrium is upset after being moved slightly. For example, the structure (a) is engineering stable but (b) is not shown in Fig.7,

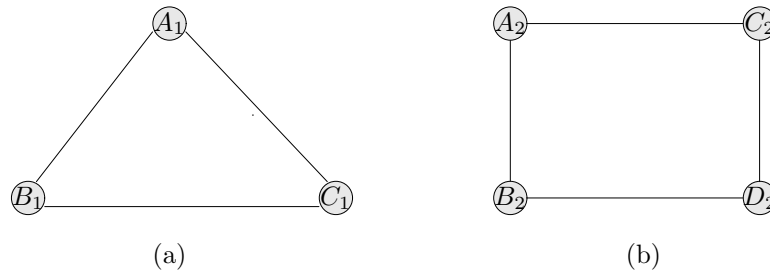

**Fig.7**

where each edge is a rigid body and each vertex denotes a hinged connection. The motion of a stable structure can be characterized similarly as a rigid body. But such a way can not be applied for instable structures for their internal deformations such as those shown in Fig.8.

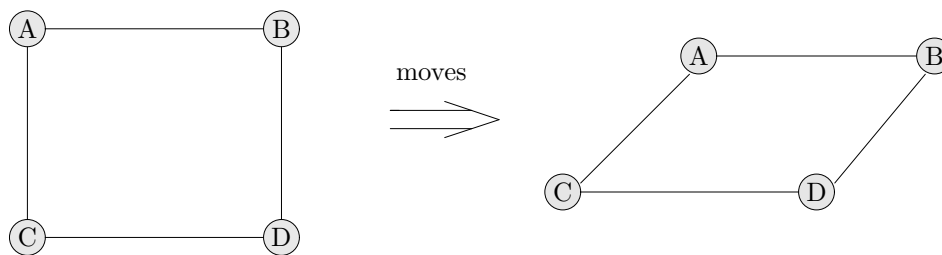

**Fig.8**

Furthermore, let  $\mathcal{P}_1, \mathcal{P}_2, \dots, \mathcal{P}_m$  be  $m$  particles in  $\mathbf{R}^3$  with some relations, for instance, the gravitation between particles  $\mathcal{P}_i$  and  $\mathcal{P}_j$  for  $1 \leq i, j \leq m$ . Thus we get an instable structure underlying a graph  $G$  with

$$V(G) = \{\mathcal{P}_1, \mathcal{P}_2, \dots, \mathcal{P}_m\};$$

$$E(G) = \{(\mathcal{P}_i, \mathcal{P}_j) | \text{there exists a relation between } \mathcal{P}_i \text{ and } \mathcal{P}_j\}.$$

For example, the underlying graph in Fig.5.4 is  $C_4$ . Assume the dynamical behavior of particle  $\mathcal{P}_i$  at time  $t$  has been completely characterized by the differential equations  $\dot{X} = F_i(X, t)$ , where  $X = (x_1, x_2, x_3)$ . Then we get a non-solvable differential equation system

$$\dot{X} = F_i(X, t), \quad 1 \leq i \leq m$$

underlying the graph  $G$ . Particularly, if all differential equations are autonomous, i.e., depend on  $X$  alone, not on time  $t$ , we get a non-solvable autonomous differential equation system

$$\dot{X} = F_i(X), \quad 1 \leq i \leq m.$$

All of these differential equation systems particularly answer a question presented in [3] for establishing the graph dynamics, and if they satisfy conditions in Theorems 2.22, 2.27 or 3.6, then they are sum-stable or prod-stable. For example, let the motion equations of 4 members in Fig.5.3 be respectively

$$AB : \ddot{X}_{AB} = 0; \quad CD : \ddot{X}_{CD} = 0, \quad AC : \ddot{X}_{AC} = a_{AC}, \quad BC : \ddot{X}_{BC} = a_{BC},$$

where  $X_{AB}, X_{CD}, X_{AC}$  and  $X_{BC}$  denote central positions of members  $AB, CD, AC, BC$  and  $a_{AC}, a_{BC}$  are constants. Solving these equations enable one to get

$$\begin{aligned} X_{AB} &= c_{AB}t + d_{AB}, & X_{AC} &= a_{AC}t^2 + c_{AC}t + d_{AC}, \\ X_{CD} &= c_{CD}t + d_{CD}, & X_{BC} &= a_{BC}t^2 + c_{BC}t + d_{BC}, \end{aligned}$$

where  $c_{AB}, c_{AC}, c_{CD}, c_{BC}, d_{AB}, d_{AC}, d_{CD}, d_{BC}$  are constants. Thus we get a non-solvable differential equation system

$$\ddot{X} = 0; \quad \ddot{X} = 0, \quad \ddot{X} = a_{AC}, \quad \ddot{X} = a_{BC},$$

or a non-solvable algebraic equation system

$$\begin{aligned} X &= c_{AB}t + d_{AB}, & X &= a_{AC}t^2 + c_{AC}t + d_{AC}, \\ X &= c_{CD}t + d_{CD}, & X &= a_{BC}t^2 + c_{BC}t + d_{BC} \end{aligned}$$

for characterizing the behavior of the instable structure in Fig.5.3 if constants  $c_{AB}, c_{AC}, c_{CD}, c_{BC}, d_{AB}, d_{AC}, d_{CD}, d_{BC}$  are different.

Now let  $X_1, X_2, \dots, X_m$  be the respectively positions in  $\mathbf{R}^3$  with initial values  $X_1^0, X_2^0, \dots, X_m^0, \dot{X}_1^0, \dot{X}_2^0, \dots, \dot{X}_m^0$  and  $M_1, M_2, \dots, M_m$  the masses of particles  $\mathcal{P}_1, \mathcal{P}_2, \dots, \mathcal{P}_m$ . If  $m = 2$ , then from Newton's law of gravitation we get that

$$\ddot{X}_1 = GM_2 \frac{X_2 - X_1}{|X_2 - X_1|^3}, \quad \ddot{X}_2 = GM_1 \frac{X_1 - X_2}{|X_1 - X_2|^3},$$

where  $G$  is the gravitational constant. Let  $X = X_2 - X_1 = (x_1, x_2, x_3)$ . Calculation shows that

$$\ddot{X} = -G(M_1 + M_2) \frac{X}{|X|^3}.$$

Such an equation can be completely solved by introducing the spherical polar coordinates

$$\begin{cases} x_1 = r \cos \phi \cos \theta \\ x_2 = r \cos \phi \sin \theta \\ x_3 = r \sin \phi \end{cases}$$

with  $r \geq 0, 0 \leq \phi \leq \pi, 0 \leq \theta < 2\pi$ , where  $r = \|X\|, \phi = \angle Xoz, \theta = \angle X'ox$  with  $X'$  the projection of  $X$  in the plane  $xoy$  are parameters with  $r = \alpha/(1 + \epsilon \cos \phi)$  hold for some

constants  $\alpha, \epsilon$ . Whence,

$$X_1(t) = GM_2 \int \left( \int \frac{X}{|X|^3} dt \right) dt \quad \text{and} \quad X_2(t) = -GM_1 \int \left( \int \frac{X}{|X|^3} dt \right) dt.$$

Notice the additivity of gravitation between particles. The gravitational action of particles  $\mathcal{P}_1, \mathcal{P}_2, \dots, \mathcal{P}_m$  on  $\mathcal{P}$  can be regarded as the respective actions of  $\mathcal{P}_1, \mathcal{P}_2, \dots, \mathcal{P}_m$  on  $\mathcal{P}$ , such as those shown in Fig.9.

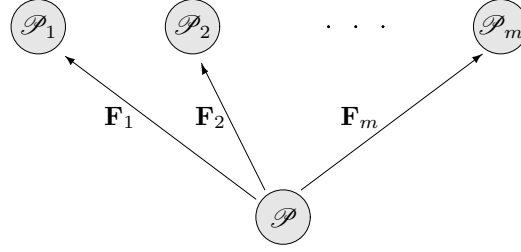

Fig.9

Thus we can establish the differential equations two by two, i.e.,  $\mathcal{P}_1$  acts on  $\mathcal{P}$ ,  $\mathcal{P}_2$  acts on  $\mathcal{P}$ ,  $\dots$ ,  $\mathcal{P}_m$  acts on  $\mathcal{P}$  and get a non-solvable differential equation system

$$\ddot{X} = GM_i \frac{X_i - X}{|X_i - X|^3}, \quad \mathcal{P}_i \neq \mathcal{P}, \quad 1 \leq i \leq m.$$

Fortunately, each of these differential equations in this system can be solved likewise that of  $m = 2$ . Not loss of generality, assume  $\hat{X}_i(t)$  to be the solution of the differential equation in the case of  $\mathcal{P}_i \neq \mathcal{P}$ ,  $1 \leq i \leq m$ . Then

$$X(t) = \sum_{\mathcal{P}_i \neq \mathcal{P}} \hat{X}_i(t) = G \sum_{\mathcal{P}_i \neq \mathcal{P}} M_i \int \left( \int \frac{X_i - X}{|X_i - X|^3} dt \right) dt$$

is nothing but the position of particle  $\mathcal{P}$  at time  $t$  in  $\mathbf{R}^3$  under the actions of  $\mathcal{P}_i \neq \mathcal{P}$  for integers  $1 \leq i \leq m$ , i.e., its position can be characterized completely by the additivity of gravitational force.

### 5.3 Global Stability of Multilateral Matters

Usually, one determines the behavior of a matter by observing its appearances revealed before one's eyes. If a matter emerges more lateralities before one's eyes, for instance the different states of a multiple state matter. We have to establish different models, particularly, differential equations for understanding that matter. In fact, each of these differential equations can be solved but they are contradictory altogether, i.e., non-solvable in common meaning. Such a multilateral matter is *globally stable* if these differential equations are sum or prod-stable in all.

Concretely, let  $S_1, S_2, \dots, S_m$  be  $m$  lateral appearances of a matter  $\mathcal{M}$  in  $\mathbf{R}^3$  which are

respectively characterized by differential equations

$$\dot{X}_i = H_i(X_i, t), \quad 1 \leq i \leq m,$$

where  $X_i \in \mathbf{R}^3$ , a 3-dimensional vector of surveying parameters for  $S_i, 1 \leq i \leq m$ . Thus we get a non-solvable differential equations

$$\dot{X} = H_i(X, t), \quad 1 \leq i \leq m \quad (DES_m^1)$$

in  $\mathbf{R}^3$ . Noticing that all these equations characterize a same matter  $\mathcal{M}$ , there must be equilibrium points  $X^*$  for all these equations. Let

$$H_i(X, t) = H'_i(X^*)X + R_i(X^*),$$

where

$$H'_i(X^*) = \begin{bmatrix} h_{11}^{[i]} & h_{12}^{[i]} & \cdots & h_{1n}^{[i]} \\ h_{21}^{[i]} & h_{22}^{[i]} & \cdots & h_{2n}^{[i]} \\ \cdots & \cdots & \cdots & \cdots \\ h_{n1}^{[i]} & h_{n2}^{[i]} & \cdots & h_{nn}^{[i]} \end{bmatrix}$$

is an  $n \times n$  matrix. Consider the non-solvable linear differential equation system

$$\dot{X} = H'_i(X^*)X, \quad 1 \leq i \leq m \quad (LDES_m^1)$$

with a basis graph  $G$ . According to Theorem 3.6, if

$$\lim_{\|X\| \rightarrow X^*} \frac{\|R_i(X)\|}{\|X\|} = 0$$

for integers  $1 \leq i \leq m$ , then the  $G$ -solution of these differential equations is asymptotically sum-stable or asymptotically prod-stable on  $G$  if each  $\text{Re}\alpha_k^{[i]} < 0$  for all eigenvalues  $\alpha_k^{[i]}$  of matrix  $H'_i(X^*)$ ,  $1 \leq i \leq m$ . Thus we therefore determine the behavior of matter  $\mathcal{M}$  is globally stable nearly enough  $X^*$ . Otherwise, if there exists such an equation which is not stable at the point  $X^*$ , then the matter  $\mathcal{M}$  is not globally stable. By such a way, if we can determine these differential equations are stable in everywhere, then we can finally conclude that  $M$  is globally stable.

Conversely, let  $\mathcal{M}$  be a globally stable matter characterized by a non-solvable differential equation

$$\dot{X} = H_i(X, t)$$

for its laterality  $S_i, 1 \leq i \leq m$ . Then the differential equations

$$\dot{X} = H_i(X, t), \quad 1 \leq i \leq m \quad (DES_m^1)$$

are sum-stable or prod-stable in all by definition. Consequently, we get a sum-stable or prod-

stable non-solvable differential equation system.

Combining all of these previous discussions, we get an interesting conclusion following.

**Conclusion 5.2** Let  $\mathcal{M}^{GS}, \overline{\mathcal{M}}^{GS}$  be respectively the sets of globally stable multilateral matters, non-stable multilateral matters characterized by non-solvable differential equation systems and  $\mathcal{DE}, \overline{\mathcal{DE}}$  the sets of sum or prod-stable non-solvable differential equation systems, not sum or prod-stable non-solvable differential equation systems. then

- (1)  $\forall \mathcal{M} \in \mathcal{M}^{GS} \Rightarrow \exists (DES_m^1) \in \mathcal{DE};$
- (2)  $\forall \mathcal{M} \in \overline{\mathcal{M}}^{GS} \Rightarrow \exists (DES_m^1) \in \overline{\mathcal{DE}}.$

Particularly, let  $\mathcal{M}$  be a multiple state matter. If all of its states are stable, then  $\mathcal{M}$  is globally stable. Otherwise, it is unstable.

## References

- [1] V.I.Arnold, V.V.Kozlov and A.I.Neishtadt, *Mathematical Aspects of Classical and Celestial Mechanics* (third edition), Springer-Verlag Berlin Heidelberg, 2006.
- [2] K.Hoffman and R.Kunze, *Linear Algebra* (2th edition), Prentice-Hall, Inc., Englewood Cliffs, New Jersey, 1971.
- [3] Linfan Mao, Combinatorial speculation and combinatorial conjecture for mathematics, *International J.Math. Combin.* Vol.1(2007), No.1, 1-19.
- [4] Linfan Mao, *Automorphism Groups of Maps, Surfaces and Smarandache Geometries* (Second edition), Graduate Textbook in Mathematics, The Education Publisher Inc. 2011.
- [5] Linfan Mao, *Smarandache Multi-Space Theory* (Second edition), Graduate Textbook in Mathematics, The Education Publisher Inc. 2011.
- [6] Linfan Mao, *Combinatorial Geometry with Applications to Field Theory* (Second edition), Graduate Textbook in Mathematics, The Education Publisher Inc. 2011.
- [7] Linfan Mao, Non-solvable spaces of linear equation systems, *International J.Math. Combin.*, Vol.2 (2012), 9-23.
- [8] W.S.Massey, *Algebraic Topology: An Introduction*, Springer-Verlag, New York, etc., 1977.
- [9] Don Mittleman and Don Jezewski, An analytic solution to the classical two-body problem with drag, *Celestial Mechanics*, 28(1982), 401-413.
- [10] F.Smarandache, Mixed noneuclidean geometries, *Eprint arXiv: math/0010119*, 10/2000.
- [11] F.Smarandache, *A Unifying Field in Logics-Neutrosopy: Neturosophic Probability, Set, and Logic*, American research Press, Rehoboth, 1999.
- [12] Walter Thirring, *Classical Mathematical Physics*, Springer-Verlag New York, Inc., 1997.
- [13] Wolfgang Walter, *Ordinary Differential Equations*, Springer-Verlag New York, Inc., 1998.

## Cauchy Problem on Non-solvable Systems of First Order Partial Differential Equations with Applications

**Abstract:** Let  $L_1, L_2, \dots, L_m$  be  $m$  partial differential operators of first order and  $h_1, h_2, \dots, h_m$  continuously differentiable functions. Then *is the partial differential equation system  $L_i[u] = h_i, 1 \leq i \leq m$  solvable for a differential mapping  $u : \mathbb{R}^n \rightarrow \mathbb{R}^n$  or not?* Similarly, let  $\varphi$  be a continuous function  $\varphi : \mathbb{R}^{n-1} \rightarrow \mathbb{R}^{n-1}$ . Then *is the Cauchy problem  $L_i[u] = h_i, 1 \leq i \leq m$  with  $u(x_1, x_2, \dots, x_{n-1}, t_0) = \varphi(x_1, x_2, \dots, x_{n-1})$  solvable or not?* If not, *how can we characterize the behavior of such a function  $u$ ?* All these questions are ignored in classical mathematics only by saying *not solvable!* In fact, non-solvable equation systems are nothing but Smarandache systems, i.e., contradictory systems themselves, in which a ruler behaves in at least two different ways within the same system, i.e., validated and invalidated, or only invalidated but in multiple distinct ways. They are widely existing in the natural world and our daily life. In this paper, we discuss non-solvable partial differential equation systems of first order by a combinatorial approach, classify these systems by underlying graphs, particularly, these non-solvable linear systems, characterize their behaviors, such as those of global stability, energy integral and their geometry, which enables one to find a differentiable manifold with preset  $m$  vector fields. Applications of such non-solvable systems to interaction fields and flows in network are also included in this paper.

**Key Words:** Non-solvable partial-differential equation, Smarandache system, vertex-edge labeled graph, global stability, energy integral, combinatorial manifold.

**AMS(2010):** 05C15, 34A30, 34A34, 37C75, 70F10, 92B05

### §1. Introduction

A partial differential equation

$$F(x_1, x_2, \dots, x_n, u, u_{x_1}, \dots, u_{x_n}, u_{x_1 x_2}, \dots, u_{x_1 x_n}, \dots) = 0 \quad (PDE)$$

on functions  $u(x_1, \dots, x_n)$  is *non-solvable* if there are no function  $u(x_1, \dots, x_n)$  on a domain  $D \subset \mathbb{R}^n$  with (PDE) holds. For example, the equation  $e^{u_{x_1} + u_{x_2}} = 0$ . Similarly, a system of partial differential equations

---

<sup>1</sup>*Methods and Applications of Analysis*, Vol.22, 2(2015), 171-200.

$$\left\{ \begin{aligned} &F_1(x_1, x_2, \dots, x_n, u, u_{x_1}, \dots, u_{x_n}, u_{x_1x_2}, \dots, u_{x_1x_n}, \dots) = 0 \\ &F_2(x_1, x_2, \dots, x_n, u, u_{x_1}, \dots, u_{x_n}, u_{x_1x_2}, \dots, u_{x_1x_n}, \dots) = 0 \\ &\dots \\ &F_m(x_1, x_2, \dots, x_n, u, u_{x_1}, \dots, u_{x_n}, u_{x_1x_2}, \dots, u_{x_1x_n}, \dots) = 0 \end{aligned} \right. \quad (PDES)$$

is *non-solvable* if there are no function  $u(x_1, \dots, x_n)$  on a domain  $D \subset \mathbb{R}^n$  with  $(PDES)$  holds.

Such non-solvable systems of partial differential equations are indeed existing. For example, H.Lewy [5] proved that there exists a function  $F(x_1, x_2, x_3) \in C^\infty(\mathbb{R}^3)$  such that the partial differential equation

$$-u_{x_1} - iu_{x_2} + 2i(x_1 + ix_2)u_{x_3} = 0$$

is non-solvable. R.Rubinsten [14] proved that

$$\begin{aligned} u_{tt} + t^n u_{xx} + (i - t^m)u_x &= 0, \quad n > 4m + 2, \quad m \equiv 1(mod2) \\ u_t - t^n u_{xx} + it^m u_x &= 0, \quad n > 2m + 1, \quad n \equiv 0(mod2) \end{aligned}$$

are non-solvable locally at the origin. It should be noted that these non-solvable linear algebraic or ordinary differential equation systems have been characterized recently by the author in the references [12]-[13].

The objective of this paper is to characterize those non-solvable partial differential equation systems of first order on one function  $u(x_1, x_2, \dots, x_n)$  by a combinatorial approach, classify these systems and characterize their behaviors with some applications. For such a objective, we should know its counterpart, i.e., solvable conditions on partial differential equations  $(PDE)$ . The following result is well-known from standard textbooks, such as those of [4] and [15].

**Theorem 1.1** *Let*

$$\left\{ \begin{aligned} &x_i = x_i(t, s_1, s_2, \dots, s_{n-1}) \\ &u = u(t, s_1, s_2, \dots, s_{n-1}) \\ &p_i = p_i(t, s_1, s_2, \dots, s_{n-1}), \quad i = 1, 2, \dots, n \end{aligned} \right. \quad (SDE)$$

be a solution of system

$$\begin{aligned} \frac{dx_1}{F_{p_1}} &= \frac{dx_2}{F_{p_2}} = \dots = \frac{dx_n}{F_{p_n}} = \frac{du}{\sum_{i=1}^n p_i F_{p_i}} \\ &= -\frac{dp_1}{F_{x_1} + p_1 F_u} = \dots = -\frac{dp_n}{F_{x_n} + p_n F_u} = dt \end{aligned}$$

with initial values

$$\begin{cases} x_{i_0} = x_{i_0}(s_1, s_2, \dots, s_{n-1}) \\ u_0 = u_0(s_1, s_2, \dots, s_{n-1}) \\ p_{i_0} = p_{i_0}(s_1, s_2, \dots, s_{n-1}), \quad i = 1, 2, \dots, n \end{cases} \quad (IDE)$$

such that

$$\begin{cases} F(x_{1_0}, x_{2_0}, \dots, x_{n_0}, u, p_{1_0}, p_{2_0}, \dots, p_{n_0}) = 0 \\ \frac{\partial u_0}{\partial s_j} - \sum_{i=0}^n p_{i_0} \frac{\partial x_{i_0}}{\partial s_j} = 0, \quad j = 1, 2, \dots, n-1. \end{cases}$$

Then (SDE) is the solution of partial differential equation

$$F(x_1, x_2, \dots, x_n, u, p_1, p_2, \dots, p_n) = 0 \quad (PDE)$$

of first order with initial values (1-2), where  $p_i = \frac{\partial u}{\partial x_i}$  and  $F_{p_i} = \frac{\partial F}{\partial p_i}$  for integers  $1 \leq i \leq n$ .

Particularly, if such a partial differential equation (PDE) of first order is linear or quasilinear, let

$$L = \sum_{i=1}^n a_i \frac{\partial}{\partial x_i}$$

be a partial differential operator of first order with continuously differentiable functions  $a_i$ ,  $1 \leq i \leq n$ . Then such a linear or quasilinear partial differential equation (PDE) of first order can be denoted by

$$L[u] \equiv \sum_{i=1}^n a_i \frac{\partial u}{\partial x_i} = c, \quad (LPDE)$$

where  $c$  is a continuously differentiable function. Let  $L_1, L_2, \dots, L_m$  be  $m$  partial differential operators of first order (linear or non-linear) and  $h_i$ ,  $1 \leq i \leq m$  continuously differentiable functions on  $\mathbb{R}^n$ . Then is the partial differential equation system

$$L_i[u(x_1, x_2, \dots, x_n)] = h_i, \quad 1 \leq i \leq m \quad (PDES_m)$$

solvable or not for a differential mapping  $u : \mathbb{R}^n \rightarrow \mathbb{R}^n$ ? Similarly, let  $\varpi_i$   $1 \leq i \leq m$  be continuous functions on  $\mathbb{R}^n$ . Then is the Cauchy problem

$$\begin{cases} L_i[u] = h_i \\ u(x_1, x_2, \dots, x_{n-1}, x_n^0) = \varpi_i, \quad 1 \leq i \leq m \end{cases} \quad (PDES_m^C)$$

solvable or not? Denoted by  $S_i^0$  the solution of  $i$ th equation in system (PDES<sub>m</sub>) or (DEPS<sub>m</sub><sup>C</sup>). Then the partial differential equation system (PDES<sub>m</sub>) or (DEPS<sub>m</sub><sup>C</sup>) is solvable only if  $\bigcap_{i=1}^m S_i^0 \neq \emptyset$ . Notice that  $u : \mathbb{R}^n \rightarrow \mathbb{R}^n$  is differentiable. Thus the systems (PDES<sub>m</sub>) or (DEPS<sub>m</sub><sup>C</sup>) is solvable only if  $\bigcap_{i=1}^m S_i^0$  is a non-empty functional set on a domain  $D \subset \mathbb{R}^n$ . Otherwise, non-solvable, i.e.,  $\bigcap_{i=1}^m S_i^0 = \emptyset$  for any domain  $D \subset \mathbb{R}^n$ . In fact, if such a system is non-solvable, it is



nothing but a Smarandache system defined in the following.

**Definition 1.4** A rule  $\mathcal{R}$  in a mathematical system  $(\Sigma; \mathcal{R})$  is said to be *Smarandachely denied* if it behaves in at least two different ways within the same set  $\Sigma$ , i.e., validated and invalidated, or only invalidated but in multiple distinct ways.

A *Smarandache system*  $(\Sigma; \mathcal{R})$  is a mathematical system which has at least one Smarandachely denied rule  $\mathcal{R}$ .

Let  $(\Sigma_1; \mathcal{R}_1), (\Sigma_2; \mathcal{R}_2), \dots, (\Sigma_m; \mathcal{R}_m)$  be mathematical systems, where  $\mathcal{R}_i$  is a rule on  $\Sigma_i$  for integers  $1 \leq i \leq m$ . If for two integers  $i, j, 1 \leq i, j \leq m, \Sigma_i \neq \Sigma_j$  or  $\Sigma_i = \Sigma_j$  but  $\mathcal{R}_i \neq \mathcal{R}_j$ , then they are said to be *different*, otherwise, *identical*. We also know the conception of Smarandache multi-space defined following.

**Definition 1.5** Let  $(\Sigma_1; \mathcal{R}_1), (\Sigma_2; \mathcal{R}_2), \dots, (\Sigma_m; \mathcal{R}_m)$  be  $m \geq 2$  mathematical spaces, different two by two. A *Smarandache multispace*  $\tilde{\Sigma}$  is a union  $\bigcup_{i=1}^m \Sigma_i$  with rules  $\tilde{\mathcal{R}} = \bigcup_{i=1}^m \mathcal{R}_i$  on  $\tilde{\Sigma}$ , i.e., the rule  $\mathcal{R}_i$  on  $\Sigma_i$  for integers  $1 \leq i \leq m$ , denoted by  $(\tilde{\Sigma}; \tilde{\mathcal{R}})$ .

A Smarandache multispace  $(\tilde{\Sigma}; \tilde{\mathcal{R}})$  inherits a combinatorial structure, i.e., a vertex-edge labeled graph defined following.

**Definition 1.6** Let  $(\tilde{\Sigma}; \tilde{\mathcal{R}})$  be a Smarandache multispace with  $\tilde{\Sigma} = \bigcup_{i=1}^m \Sigma_i$  and  $\tilde{\mathcal{R}} = \bigcup_{i=1}^m \mathcal{R}_i$ . Its underlying graph  $G[\tilde{\Sigma}, \tilde{\mathcal{R}}]$  is a labeled simple graph defined by

$$\begin{aligned}
 V(G[\tilde{\Sigma}, \tilde{\mathcal{R}}]) &= \{\Sigma_1, \Sigma_2, \dots, \Sigma_m\}, \\
 E(G[\tilde{\Sigma}, \tilde{\mathcal{R}}]) &= \{(\Sigma_i, \Sigma_j) \mid \Sigma_i \cap \Sigma_j \neq \emptyset, 1 \leq i, j \leq m\}
 \end{aligned}$$

with an edge labeling

$$l^E : (\Sigma_i, \Sigma_j) \in E(G[\tilde{\Sigma}, \tilde{\mathcal{R}}]) \rightarrow l^E(\Sigma_i, \Sigma_j) = \varpi(\Sigma_i \cap \Sigma_j),$$

where  $\varpi$  is a characteristic on  $\Sigma_i \cap \Sigma_j$  such that  $\Sigma_i \cap \Sigma_j$  is isomorphic to  $\Sigma_k \cap \Sigma_l$  if and only if  $\varpi(\Sigma_i \cap \Sigma_j) = \varpi(\Sigma_k \cap \Sigma_l)$  for integers  $1 \leq i, j, k, l \leq m$ .

An equation or a system of equations is said *reducible* if it can be reduced from another(s) with the same solutions. Now let  $(PDES_m)$  be a system of partial differential equations with

$$\begin{cases}
 F_1(x_1, x_2, \dots, x_n, u, u_{x_1}, \dots, u_{x_n}, u_{x_1x_2}, \dots, u_{x_1x_n}, \dots) = 0 \\
 F_2(x_1, x_2, \dots, x_n, u, u_{x_1}, \dots, u_{x_n}, u_{x_1x_2}, \dots, u_{x_1x_n}, \dots) = 0 \\
 \dots\dots\dots \\
 F_m(x_1, x_2, \dots, x_n, u, u_{x_1}, \dots, u_{x_n}, u_{x_1x_2}, \dots, u_{x_1x_n}, \dots) = 0
 \end{cases}$$



of partial differential equations of first order is non-solvable with initial values

$$\left\{ \begin{array}{l} x_i|_{x_n=x_n^0} = x_i^0(s_1, s_2, \dots, s_{n-1}) \\ u|_{x_n=x_n^0} = u_0(s_1, s_2, \dots, s_{n-1}) \\ p_i|_{x_n=x_n^0} = p_i^0(s_1, s_2, \dots, s_{n-1}), \quad i = 1, 2, \dots, n \end{array} \right.$$

if and only if the system

$$F_k(x_1, x_2, \dots, x_n, u, p_1, p_2, \dots, p_n) = 0, \quad 1 \leq k \leq m$$

is algebraically contradictory, in this case, there must be an integer \$k\_0\$, \$1 \leq k\_0 \leq m\$ such that

$$F_{k_0}(x_1^0, x_2^0, \dots, x_{n-1}^0, x_n^0, u_0, p_1^0, p_2^0, \dots, p_n^0) \neq 0$$

or it is differentially contradictory itself, i.e., there is an integer \$j\_0\$, \$1 \leq j\_0 \leq n - 1\$ such that

$$\frac{\partial u_0}{\partial s_{j_0}} - \sum_{i=0}^{n-1} p_i^0 \frac{\partial x_i^0}{\partial s_{j_0}} \neq 0.$$

*Proof* If the Cauchy problem

$$\left. \begin{array}{l} F_k(x_1, x_2, \dots, x_n, u, p_1, p_2, \dots, p_n) = 0 \\ x_i|_{x_n=x_n^0} = x_i^0, \quad u|_{x_n=x_n^0} = u_0, \quad p_i|_{x_n=x_n^0} = p_i^0, \quad i = 1, 2, \dots, n \end{array} \right\}, \quad 1 \leq k \leq m$$

of partial differential equations of first order is solvable, it is clear that the symbol of system of partial differential equations

$$\left\{ \begin{array}{l} F_1(x_1, x_2, \dots, x_n, u, p_1, p_2, \dots, p_n) = 0 \\ F_2(x_1, x_2, \dots, x_n, u, p_1, p_2, \dots, p_n) = 0 \\ \dots \\ F_m(x_1, x_2, \dots, x_n, u, p_1, p_2, \dots, p_n) = 0 \end{array} \right.$$

can not be contradictory, i.e., compatible. Furthermore, if it is algebraically contradictory, then there must be an integer \$k\_0\$ such that

$$F_{k_0}(x_1^0, x_2^0, \dots, x_{n-1}^0, x_n^0, u_0, p_1^0, p_2^0, \dots, p_n^0) \neq 0.$$

Otherwise, the \$x\_i^0, u\_0, p\_i^0, 1 \leq i \leq n\$ is a solution of the system, a contradiction.

Notice that \$u\_0 = u(x\_1^0, \dots, x\_n^0) = u(x\_1^0(s\_1, \dots, s\_{n-1}), \dots, x\_n^0(s\_1, \dots, s\_{n-1}))\$. There must be

$$\frac{\partial u_0}{\partial s_j} - \sum_{i=0}^{n-1} p_i^0 \frac{\partial x_i^0}{\partial s_j} = 0$$

for any integer \$j\$, \$1 \leq j \leq n - 1\$.

Now if the system of partial differential equations

$$\left\{ \begin{array}{l} F_1(x_1, x_2, \dots, x_n, u, p_1, p_2, \dots, p_n) = 0 \\ F_2(x_1, x_2, \dots, x_n, u, p_1, p_2, \dots, p_n) = 0 \\ \dots\dots\dots \\ F_m(x_1, x_2, \dots, x_n, u, p_1, p_2, \dots, p_n) = 0 \end{array} \right.$$

is not algebraically contradictory, we can find its non-trivial solutions  $x_i^0, u_0, p_i^0, 1 \leq i \leq n$ .  
Furthermore, if

$$\frac{\partial u_0}{\partial s_j} - \sum_{i=0}^{n-1} p_i^0 \frac{\partial x_i^0}{\partial s_j} = 0$$

for any integer  $j, 1 \leq j \leq n - 1$ , then the Cauchy problem

$$\left\{ \begin{array}{l} F_k(x_1, x_2, \dots, x_n, u, p_1, p_2, \dots, p_n) = 0 \\ x_i|_{x_n=x_n^0} = x_i^0, u|_{x_n=x_n^0} = u_0, p_i|_{x_n=x_n^0} = p_i^0, i = 1, 2, \dots, n \end{array} \right.$$

is solvable by Theorem 1.1.

Let

$$\left\{ \begin{array}{l} x_i^{[k]} = x_i^{[k]}(t, s_1, s_2, \dots, s_{n-1}) \\ u^{[k]} = u^{[k]}(t, s_1, s_2, \dots, s_{n-1}) \\ p_i^{[k]} = p_i^{[k]}(t, s_1, s_2, \dots, s_{n-1}), \quad i = 1, 2, \dots, n \end{array} \right.$$

be the solution of Cauchy problem

$$\left\{ \begin{array}{l} F_k(x_1, x_2, \dots, x_n, u, p_1, p_2, \dots, p_n) = 0 \\ x_i|_{x_n=x_n^0} = x_i^0, u|_{x_n=x_n^0} = u_0, p_i|_{x_n=x_n^0} = p_i^0, i = 1, 2, \dots, n \end{array} \right.$$

of partial differential equation of first order for an integer  $1 \leq k \leq m$ , i.e., the solution of its characteristic system

$$\begin{aligned} \frac{dx_1}{F_{kp_1}} &= \frac{dx_2}{F_{kp_2}} = \dots = \frac{dx_n}{F_{kp_n}} = \frac{du}{\sum_{i=1}^n p_i F_{kp_i}} \\ &= -\frac{dp_1}{F_{kx_1} + p_1 F_{ku}} = \dots = -\frac{dp_n}{F_{kx_n} + p_n F_{ku}} = dt \end{aligned}$$

with initial values  $x_i^0, u_0, p_i^0, 1 \leq i \leq n$ .

Without loss of generality, denoted by  $S^{[k]}$  all of its solutions  $x_i^{[k]}, u^{[k]}, p_i^{[k]}, 1 \leq i \leq n$ . Then

$$\bigcap_{k=1}^m S^{[k]} \supseteq \{x_i^0, u_0, p_i^0, 1 \leq i \leq n\} \neq \emptyset.$$

Thus the Cauchy problem on partial differential equations

$$\left\{ \begin{array}{l} F_1(x_1, x_2, \dots, x_n, u, p_1, p_2, \dots, p_n) = 0 \\ F_2(x_1, x_2, \dots, x_n, u, p_1, p_2, \dots, p_n) = 0 \\ \dots\dots\dots \\ F_m(x_1, x_2, \dots, x_n, u, p_1, p_2, \dots, p_n) = 0 \end{array} \right.$$

of first order with initial values

$$\left\{ \begin{array}{l} x_i^0 = x_i^0(s_1, s_2, \dots, s_{n-1}) \\ u_0 = u_0(s_1, s_2, \dots, s_{n-1}) \\ p_i^0 = p_i^0(s_1, s_2, \dots, s_{n-1}), \quad i = 1, 2, \dots, n \end{array} \right.$$

is solvable. This completes the proof. □

**Corollary 2.2** *Let*

$$\left\{ \begin{array}{l} F_1(x_1, x_2, \dots, x_n, u, p_1, p_2, \dots, p_n) = 0 \\ F_2(x_1, x_2, \dots, x_n, u, p_1, p_2, \dots, p_n) = 0 \end{array} \right.$$

*be an algebraically contradictory system of partial differential equations of first order. Then there are no values  $x_i^0, u_0, p_i^0, 1 \leq i \leq n$  such that*

$$\left\{ \begin{array}{l} F_1(x_1^0, x_2^0, \dots, x_{n-1}^0, x_n^0, u_0, p_1^0, p_2^0, \dots, p_n^0) = 0, \\ F_2(x_1^0, x_2^0, \dots, x_{n-1}^0, x_n^0, u_0, p_1^0, p_2^0, \dots, p_n^0) = 0. \end{array} \right.$$

**Corollary 2.3** *A Cauchy problem*

$$\left\{ \begin{array}{l} F_1(x_1, x_2, \dots, x_n, u, p_1, p_2, \dots, p_n) = 0 \\ F_2(x_1, x_2, \dots, x_n, u, p_1, p_2, \dots, p_n) = 0 \\ \dots\dots\dots \\ F_m(x_1, x_2, \dots, x_n, u, p_1, p_2, \dots, p_n) = 0 \end{array} \right.$$

*of first order with*

$$F_k(x_1^0, x_2^0, \dots, x_{n-1}^0, x_n^0, u_0, p_1^0, p_2^0, \dots, p_n^0) = 0, \quad 1 \leq k \leq m$$

*for values  $x_i^0, u_0, p_i^0, 1 \leq i \leq n$  is non-solvable if and only if there is an integer  $j_0, 1 \leq j_0 \leq n-1$  such that*

$$\frac{\partial u_0}{\partial s_{j_0}} - \sum_{i=0}^{n-1} p_i^0 \frac{\partial x_i^0}{\partial s_{j_0}} \neq 0.$$

If the system  $(PDES_m)$  is linear or quasilinear, i.e.,

$$\sum_{i=1}^n a_i^{[k]} \frac{\partial u}{\partial x_i} = c^{[k]}, \quad 1 \leq k \leq m, \quad (LPDES_m)$$

then

$$F_k = \sum_{i=1}^n a_i^{[k]} \frac{\partial u}{\partial x_i} - c^{[k]} = \sum_{i=1}^n a_i^{[k]} p_i + b^{[k]} p_t - c^{[k]}$$

for integers  $1 \leq k \leq m$ .

Calculation shows that  $F_{kp_i} = a_i^{[k]}$ ,  $1 \leq k \leq m$  and

$$\begin{aligned} \sum_{i=1}^n p_i F_{kp_i} &= \sum_{i=1}^n a_i^{[k]} p_i = c^{[k]}, \\ F_{kx_l} &= \sum_{i=1}^n a_{ix_l}^{[k]} p_i - c_{x_l}^{[k]}, \quad F_{ku} = \sum_{i=1}^n a_{iu}^{[k]} p_i - c_u^{[k]} \end{aligned}$$

and

$$\frac{\partial}{\partial x_l} \left( \sum_{i=1}^n a_i^{[k]} p_i - c^{[k]} \right) = \sum_{i=1}^n \left( a_{ix_l}^{[k]} p_i + a_{iu}^{[k]} p_l p_i + a_i^{[k]} p_{ix_l} \right) - \left( c_{x_l}^{[k]} + c_u^{[k]} p_l \right) = 0.$$

We know that

$$F_{kx_l} + p_l F_u = \sum_{i=1}^n a_i^{[k]} p_{ix_l} = \sum_{i=1}^n a_i^{[k]} p_{lx_i}.$$

Notice that on a solution surface  $u(x_1, \dots, x_n)$ ,

$$\frac{dp_l}{dx_l} = \sum_{i=1}^n p_{lx_i} \frac{dx_i}{dx_l} = \sum_{i=1}^n p_{lx_i} \frac{a_i^{[k]}}{a_l^{[k]}},$$

which implies that

$$\frac{dx_i}{a_i^{[k]}} = \frac{dp_l}{F_{kx_l} + p_l F_u} = \frac{dp_l}{\sum_{i=1}^n a_i^{[k]} p_{lx_i}}$$

is an identity. Thus, if the system  $(PDES_m)$  is linear or quasilinear system  $(LPDES_m)$ , we only need to consider the characteristic system

$$\frac{dx_1}{F_{kp_1}} = \frac{dx_2}{F_{kp_2}} = \dots = \frac{dx_n}{F_{kp_n}} = \frac{du}{\sum_{i=1}^n p_i F_{kp_i}}$$

for finding solutions  $u(x_1, \dots, x_n)$ . Furthermore, we only need to prescribe the initial data by  $u|_{x_n=x_n^0}$ , then the condition

$$\frac{\partial u_0}{\partial s_{j_0}} - \sum_{i=0}^n p_i^0 \frac{\partial x_i^0}{\partial s_{j_0}} = 0$$



Solving this algebraic system, we know that

$$\begin{cases} x = \frac{\bar{\varphi}_1 \pm \sqrt{\bar{\varphi}_2 - \bar{\varphi}_1^2}}{2}, \\ y = \frac{\bar{\varphi}_1 \mp \sqrt{\bar{\varphi}_2 - \bar{\varphi}_1^2}}{2}. \end{cases}$$

Hence, the solution of

$$\begin{cases} (z - y)u_x + (x - z)u_y + (y - x)u_z = 0 \\ u|_{z=0} = e^{x+y} \end{cases}$$

is  $u = e^{x+y} = e^{\bar{\varphi}_1} = e^{x+y+z}$ .

Similarly, the characteristic system of its second equation is

$$\frac{dx}{xz} = \frac{dy}{yz} = \frac{dz}{z}$$

with two independent initial integrals

$$\psi_1 = \frac{x}{e^z}, \quad \psi_2 = \frac{y}{e^z},$$

which implies that  $x = \bar{\psi}_1$ ,  $y = \bar{\psi}_2$ . Whence, the solution of

$$\begin{cases} xzu_x + yzu_y + zu_z = 0 \\ u|_{z=0} = e^{x+y} \end{cases}$$

is  $u = e^{x+y} = e^{\frac{x+y}{e^z}}$ . Consequently,  $u = e^{x+y+z} = e^{\frac{x+y}{e^z}}$ . Calculation shows that

$$x + y + \frac{e^z}{e^e - 1}z = 0,$$

which is the domain of solutions of the partial differential equation system.

For the non-solvability of shifted partial differential equations of first order, we know the following result.

**Theorem 2.7** *A Cauchy problem on systems*

$$\begin{cases} F_1(x_1, \dots, x_n, x_{n+1}^{[1]}, \dots, x_{n_1}^{[1]}, u, p_1, \dots, p_n, p_{n+1}^{[1]}, \dots, p_{n_1}^{[1]}) = 0 \\ F_2(x_1, \dots, x_n, x_{n+1}^{[2]}, \dots, x_{n_2}^{[2]}, u, p_1, \dots, p_n, p_{n+1}^{[2]}, \dots, p_{n_2}^{[2]}) = 0 \\ \dots \\ F_m(x_1, \dots, x_n, x_{n+1}^{[m]}, \dots, x_{n_m}^{[m]}, u, p_1, \dots, p_n, p_{n+1}^{[m]}, \dots, p_{n_m}^{[m]}) = 0 \end{cases}$$

*of partial differential equations of first order is non-solvable with initial values*



$$\begin{cases} u_0 = u_0(s_1, s_2, \dots, s_{n_m-1}) \\ x_i^0 = x_i^0(s_1, s_2, \dots, s_{n_m-1}), 1 \leq i \leq n \text{ and } x_i^0 = 0, i \geq n + 1 \\ p_i^0 = p_i^0(s_1, s_2, \dots, s_{n_m-1}), 1 \leq i \leq n \text{ and } p_i^0 = 0, i \geq n + 1, \end{cases}$$

where  $x_1, \dots, x_n, x_{n+1}^{[1]}, \dots, x_{n_1}^{[1]}, x_{n+1}^{[2]}, \dots, x_{n_2}^{[2]}, \dots, x_{n+1}^{[m]}, \dots, x_{n_m}^{[m]}$  are independent,  $p_k^{[i]} = \partial u / \partial x_k^{[i]}$  and  $n \leq n_1 \leq n_2 \leq \dots \leq n_m$  if and only if there are integers  $\{n_{i_1}, n_{i_2}, \dots, n_{i_l}\} \subset \{n_1, n_2, \dots, n_m\}$ ,  $n_{i_1} = n_{i_2} = \dots = n_{i_l} = n$  such that the system

$$\begin{cases} F_{i_1}(x_1, \dots, x_n, u, p_1, \dots, p_n) = 0 \\ F_{i_2}(x_1, \dots, x_n, u, p_1, \dots, p_n) = 0 \\ \dots\dots\dots\dots\dots\dots\dots\dots\dots\dots\dots\dots\dots\dots\dots\dots\dots\dots \\ F_{i_l}(x_1, \dots, x_n, u, p_1, \dots, p_n) = 0 \end{cases}$$

is algebraically contradictory, in this case, there must be an integer  $k_0, 1 \leq k_0 \leq l$  such that

$$F_{i_{k_0}}(x_1^0, x_2^0, \dots, x_{n-1}^0, x_n^0, u_0, p_1^0, p_2^0, \dots, p_n^0) \neq 0$$

or it is differentially contradictory itself, i.e., there is an integer  $j_0, 1 \leq j_0 \leq n_m - 1$  such that

$$\frac{\partial u_0}{\partial s_{j_0}} - \sum_{i=0}^n p_i^0 \frac{\partial x_i^0}{\partial s_{j_0}} \neq 0.$$

*Proof* Notice that  $x_1, \dots, x_n, x_{n+1}^{[1]}, \dots, x_{n_1}^{[1]}, x_{n+1}^{[2]}, \dots, x_{n_2}^{[2]}, \dots, x_{n+1}^{[m]}, \dots, x_{n_m}^{[m]}$  are independent. Whence, if  $n_i \neq n_j$ , the system

$$\begin{cases} F_i(x_1, \dots, x_n, x_{n+1}^{[1]}, \dots, x_{n_1}^{[1]}, u, p_1, \dots, p_n, p_{n+1}^{[1]}, \dots, p_{n_1}^{[1]}) = 0 \\ F_j(x_1, \dots, x_n, x_{n+1}^{[2]}, \dots, x_{n_2}^{[2]}, u, p_1, \dots, p_n, p_{n+1}^{[2]}, \dots, p_{n_2}^{[2]}) = 0 \end{cases}$$

must be algebraically compatible. Furthermore, for any integer  $1 \leq k \leq m$  we know the Cauchy problem

$$\begin{cases} F_k(x_1, \dots, x_n, x_{n+1}^{[k]}, \dots, x_{n_1}^{[k]}, u, p_1, \dots, p_n, p_{n+1}^{[k]}, \dots, p_{n_1}^{[k]}) = 0, \\ x_i|_{x_n=x_n^0} = x_i^0(s_1, s_2, \dots, s_{n_m-1}), 1 \leq i \leq n; x_i^{[k]}|_{x_n=x_n^0} = 0, i \geq n + 1, \\ u|_{x_n=x_n^0} = u_0(s_1, s_2, \dots, s_{n_m-1}), \\ p_i|_{x_n=x_n^0} = p_i^0(s_1, s_2, \dots, s_{n_m-1}), 1 \leq i \leq n; p_i^{[k]}|_{x_n=x_n^0} = 0, i \geq n + 1 \end{cases}$$

is solvable by Theorem 1.1 if

$$\frac{\partial u_0}{\partial s_j} - \sum_{i=0}^n p_i^0 \frac{\partial x_i^0}{\partial s_j} = 0$$

for any integer  $1 \leq j \leq n_m - 1$ . Whence, the conclusion follows by a similar way to that of Theorem 2.1. □



vertex-edge labeled graph, denoted by  $G_0[PDES_m^C]$ . Clearly,  $\widehat{G}[PDES_m^C] \simeq \widehat{G}_0[PDES_m^C]$ .

Then the following results on  $\widehat{G}[PDES_m^C]$  are easily know by definition.

**Theorem 3.1** *If  $\widehat{G}[PDES_m^C] \not\simeq K_m$ , or  $\widehat{G}[PDES_m^C] \simeq K_m$  but there are integers  $1 \leq i, j, k \leq m$  such that  $S^{[i]} \cap S^{[j]} \cap S^{[k]} = \emptyset$ , where  $m$  is the number of equations in  $(PDES_m^C)$ , then  $(PDES_m^C)$  is non-solvable.*

*Proof* Clearly, if the system  $(PDES_m^C)$  is solvable, then any subsystem of equations in  $(PDES_m^C)$  is solvable. This fact implies that  $\widehat{G}[PDES_m^C]$  is a complete graph and for three integers  $1 \leq i, j, k \leq m$ ,  $S^{[i]} \cap S^{[j]} \cap S^{[k]} \neq \emptyset$ . Thus, if  $\widehat{G}[PDES_m^C] \not\simeq K_m$ , or  $S^{[i]} \cap S^{[j]} \cap S^{[k]} = \emptyset$  for three integers  $1 \leq i, j, k \leq m$ , then the Cauchy problem  $(PDES_m^C)$  is non-solvable.  $\square$

The following result enables one to introduce the conception of  $G$ -solution of partial differential equations of first order.

**Theorem 3.2** *For any system  $(PDES_m^C)$  of partial differential equations of first order,  $\widehat{G}[PDES_m^C]$  is simple. Conversely, for any simple graph  $G$ , there is a system  $(PDES_m^C)$  of partial differential equations of first order such that  $\widehat{G}[PDES_m^C] \simeq G$ .*

*Proof* By definition, it is clear that the graph  $\widehat{G}[PDES_m^C]$  is simple for any system  $(PDES_m^C)$  of partial differential equations of first order. Notice that for any partial differential equation

$$F(x_1, x_2, \dots, x_n, u, p_1, p_2, \dots, p_n) = 0,$$

there are infinitely partial differential equations algebraically contradictory with it, for example, the equation

$$F(x_1, x_2, \dots, x_n, u, p_1, p_2, \dots, p_n) + s = 0,$$

and there are also infinitely partial differential equations not algebraically contradictory with it, for example, the equation

$$F(x_1, x_2, \dots, x_n, u, p_1 + s, p_2 + s, \dots, p_n + s) = 0$$

for a real number  $s \neq 0$ . All of these facts enables one to construct a system  $(PDES_m^C)$  of partial differential equations such that  $G[PDES_m^C] \simeq G$ .

For  $\forall v_1 \in V(G)$ , label it with  $S^{[v_1]}$ , where  $S^{[v_1]}$  is the solution space of Cauchy problem

$$\begin{cases} F_{v_1}(x_1, \dots, x_n, u, p_1, \dots, p_n) = 0, \\ x_i|_{x_n=x_n^0} = x_{i_0}^{v_1}, u|_{x_n=x_n^0} = u_0^{v_1}, p_i|_{x_n=x_n^0} = p_{i_0}^{v_1}. \end{cases}$$

If vertices  $v_1, v_2, \dots, v_k$  have been labeled and  $V(G) \setminus \{v_1, v_2, \dots, v_k\} \neq \emptyset$ , let  $v_{k+1} \in V(G) \setminus \{v_1, v_2, \dots, v_k\}$ . Not loss of generality, assume  $\{v_1, v_2, \dots, v_k\} = \{v_{i_1}, v_{i_2}, \dots, v_{i_l}\} \cup \{v_{j_1}, v_{j_2}, \dots, v_{j_{k-l}}\}$  such that  $v_{k+1}v_{i_s} \in E(G)$ ,  $1 \leq s \leq k$  and  $v_{k+1}v_{j_t} \notin E(G)$ ,  $1 \leq t \leq k-l$ . Label the vertex

$v_{k+1}$  by  $S^{[v_{k+1}]}$ , where  $S^{[v_{k+1}]}$  is the solution space of such a Cauchy problem

$$\begin{cases} F_{v_{k+1}}(x_1, \dots, x_n, u, p_1, \dots, p_n) = 0, \\ x_i|_{x_n=x_n^0} = x_{i_0}^{v_{k+1}}, \quad u|_{x_n=x_n^0} = u_0^{v_{k+1}}, \quad p_i|_{x_n=x_n^0} = p_{i_0}^{v_{k+1}} \end{cases}$$

that

$$\begin{cases} F_{v_{k+1}}(x_1, \dots, x_n, u, p_1, \dots, p_n) = 0, \\ F_{v_{i_s}}(x_1, \dots, x_n, u, p_1, \dots, p_n) = 0 \end{cases}$$

is algebraically compatible for integers  $1 \leq s \leq l$  but the system

$$\begin{cases} F_{v_{k+1}}(x_1, \dots, x_n, u, p_1, \dots, p_n) = 0, \\ F_{v_{j_t}}(x_1, \dots, x_n, u, p_1, \dots, p_n) = 0 \end{cases}$$

is algebraically contradictory for integers  $1 \leq t \leq k-l$ . As we discussed previous, such a partial differential equation

$$F_{v_{k+1}}(x_1, \dots, x_n, u, p_1, \dots, p_n) = 0$$

can be always chosen.

Continuing this process, all vertices in  $G$  are labeled by the induction and we get a system  $(PDES_m^C)$  of partial differential equations

$$\begin{cases} F_v(x_1, \dots, x_n, u, p_1, \dots, p_n) = 0, \quad v \in V(G), \\ x_i|_{x_n=x_n^0} = x_{i_0}^v, \quad u|_{x_n=x_n^0} = u_0^v, \quad p_i|_{x_n=x_n^0} = p_{i_0}^v. \end{cases}$$

Clearly, such a system  $(PDES_m^C)$  with  $\widehat{G}[PDES_m^C] \simeq G$  by construction. In fact, the bijection  $\varphi : S^{[v]} \in V(G[PDES_m^C]) \rightarrow v \in V(G)$  is a graph isomorphism from  $\widehat{G}[PDES_m^C]$  to  $G$ . This completes the proof.  $\square$

Notice that the symbol of a linear partial differential equation

$$F(x_1, \dots, x_n, u, p_1, \dots, p_n) = 0$$

of first order is a superplane in  $\mathbb{R}^{2n+1}$ . Thus for an algebraically contradictory linear system

$$\begin{cases} F_i(x_1, \dots, x_n, u, p_1, \dots, p_n) = 0 \\ F_j(x_1, \dots, x_n, u, p_1, \dots, p_n) = 0, \end{cases}$$

if

$$F_k(x_1, \dots, x_n, u, p_1, \dots, p_n) = 0$$

is contradictory to one of there two partial differential equations, then it must be contradictory to another. This fact enables one to classify equations in  $(LPDES_m)$  by contradictory property and determine its  $\widehat{G}[LPDES_m^C]$  following.

**Theorem 3.3** Let  $(LPDES_m)$  be a system of linear partial differential equations of first order with maximal contradictory classes  $\mathcal{C}_1, \mathcal{C}_2, \dots, \mathcal{C}_s$  on equations in  $(LPDES)$ . Then  $\widehat{G}[LPDES_m^C] \simeq K(\mathcal{C}_1, \mathcal{C}_2, \dots, \mathcal{C}_s)$ , i.e., an  $s$ -partite complete graph.

*Proof* By definition, these equations in a contradictory class  $\mathcal{C}_i, 1 \leq i \leq s$  are contradictory. Thus there are no edges between them. Similarly, these equations in two different contradictory classes  $\mathcal{C}_i, \mathcal{C}_j, 1 \leq i \neq j \leq s$  can not be contradictory. Thus there are edges between them. Whence,  $\widehat{G}[LPDES_m^C]$  is nothing but the  $s$ -partite complete graph  $K(\mathcal{C}_1, \mathcal{C}_2, \dots, \mathcal{C}_s)$ .  $\square$

**Example 3.4** Let us consider the following Cauchy problems

$$\begin{cases} u_t + au_x = 0 \\ u_t + xu_x = 0 \\ u_t + au_x + e^t = 0 \\ u|_{t=0} = \phi(x). \end{cases} \tag{3.1}$$

Clearly, it is algebraically contradictory because  $e^t \neq 0$  for any value  $t$  but

$$\begin{cases} u_t + au_x = 0 \\ u_t + xu_x = 0 \\ u|_{t=0} = \phi(x) \end{cases} \quad \text{and} \quad \begin{cases} tu_t + u_x = 0 \\ u_t + au_x + e^t = 0 \\ u|_{t=0} = \phi(x) \end{cases}$$

are not algebraically contradictory. The vertex-edge labeled graph  $G[(3.1)]$  of Cauchy problem (3.1) is shown in Fig.1,



**Fig.1**

where  $S^{[1]}, S^{[2]}$  and  $S^{[3]}$  are determined by solving these Cauchy problems

$$(1) \begin{cases} u_t + au_x = 0 \\ u|_{t=0} = \phi(x) \end{cases}, \quad (2) \begin{cases} u_t + xu_x = 0 \\ u|_{t=0} = \phi(x) \end{cases} \quad \text{and} \quad (3) \begin{cases} u_t + au_x + e^t = 0 \\ u|_{t=0} = \phi(x), \end{cases}$$

respectively. Calculation shows that

$$S^{[1]} = \{\phi(x - at)\}, \quad S^{[2]} = \{\phi(\frac{x}{e^t})\}, \quad S^{[3]} = \{\phi(x - at) - e^t + 1\}$$

and

$$S^{[1]} \cap S^{[2]} = \{\phi(x - at) = \phi(\frac{x}{e^t})\}, \quad S^{[2]} \cap S^{[3]} = \{\phi(\frac{x}{e^t}) = \phi(x - at) - e^t + 1\}.$$

**Definition 3.5** Let  $(PDES_m^C)$  be the Cauchy problem of a partial differential equation system of first order. Then the vertex-edge labeled graph  $G[PDES_m^C]$  is called its topological graph solution and  $G_0[PDES_m^C]$  the initial topological graph solution, abbreviated to  $G$ -solution, initial  $G$ -solution, respectively.

Combining this definition with that of Theorems 3.2 and 3.3, the following conclusion is holden immediately.

**Theorem 3.6** A Cauchy problem on system  $(PDES_m)$  of partial differential equations of first order with initial values  $x_i^{[k^0]}, u_0^{[k]}, p_i^{[k^0]}, 1 \leq i \leq n$  for the  $k$ th equation in  $(PDES_m), 1 \leq k \leq m$  such that

$$\frac{\partial u_0^{[k]}}{\partial s_j} - \sum_{i=0}^n p_i^{[k^0]} \frac{\partial x_i^{[k^0]}}{\partial s_j} = 0$$

is uniquely  $G$ -solvable, i.e.,  $G[PDES]$  is uniquely determined.

Applying the combinatorial structures of  $G$ -solutions of partial differential equations, we classify them following.

**Definition 3.7** Let  $(PDES)_1$  and  $(PDES)_2$  be two reduced systems of partial differential equations of first order in  $\mathbb{R}^n$  with vertex-edge labeled graphs  $G_1[PDES], G_2[PDES]$ . The two systems  $(PDES)_1$  and  $(PDES)_2$  are called to be isometric if  $\widehat{G}_1[PDES] \stackrel{\theta}{\simeq} \widehat{G}_2[PDES]$  with  $h(l(v)) = l(\theta(v))$  for  $\forall v \in \widehat{G}_1[PDES]$ , where  $h$  is an isometry on  $\mathbb{R}^{n+1}$ , denoted by  $(PDES)_1 \stackrel{\theta}{\sim} (PDES)_2$ . Particularly, if  $h = \text{identity}$ , i.e.,  $l(v) = l(\theta(v))$  for  $\forall v \in \widehat{G}_1[PDES]$ ,  $(PDES)_1$  and  $(PDES)_2$  are called to be isotopy, denoted by  $(PDES)_1 \stackrel{\theta}{=} (PDES)_2$ .

Let  $h$  be an isometry on  $\mathbb{R}^{n+1}$ . Denoted by  $(PDES)^h$  such a system replaced  $x_1, x_2, \dots, x_n$  by  $h(x_1), h(x_2), \dots, h(x_n)$  and  $p_i$  by  $\partial u / \partial h(x_i)$  for each equation in  $(PDES)$ . Then we know the following result on isometric equations.

**Theorem 3.8**  $(PDES)_1 \stackrel{\theta}{\sim} (PDES)_2$  if and only if there is an isometry  $h$  on  $\mathbb{R}^{n+1}$  such that  $(PDES)_1^h \stackrel{\theta}{=} (PDES)_2$ . Particularly,  $(PDES)_1 \stackrel{\theta}{=} (PDES)_2$  if and only if  $G_1[PDES] \stackrel{\theta}{\simeq} G_2[PDES]$ , i.e., reduced partial differential equations in  $(PDES)_1$  are the same as those of reduced equations in  $(PDES)_2$ .

*Proof* Notice that  $G_1[PDES] \stackrel{\theta}{\simeq} G_2[PDES]$  in  $\mathbb{R}^{n+1}$  if and only if the  $G$ -solutions of  $(PDES)_1$  and  $(PDES)_2$  are coincident. By definition, if  $(PDES)_1 \stackrel{\theta}{\sim} (PDES)_2$ , then there is an isometry  $h$  such that  $\widehat{G}_1[PDES] \simeq \widehat{G}_2[PDES]$  with  $h(l(v)) = l(\theta(v))$  for  $\forall v \in \widehat{G}_1[PDES]$ , i.e.,  $h$  is an isometry between the  $G$ -solutions of  $(PDES)_1$  and  $(PDES)_2$ . Without loss of generality, let  $h$  map the  $G_1$ -solution to  $G_2$ -solution. Then it implies that  $G[(PDES)_1^h] \stackrel{\theta}{\simeq} G_2[PDES]$ . Thus  $(PDES)_1^h \stackrel{\theta}{=} (PDES)_2$ .

Particularly, if  $(PDES)_1 \stackrel{\theta}{=} (PDES)_2$ , there must be  $\widehat{G}_1[PDES] \stackrel{\theta}{\simeq} \widehat{G}_2[PDES]$  and  $l(v) = l(\theta(v))$  for  $\forall v \in \widehat{G}_1[PDES]$ . Thus  $G_1[PDES] \stackrel{\theta}{\simeq} G_2[PDES]$ , i.e., the  $G_1$ -solutions of  $(PDES)_1$  are coincident with that of  $(PDES)_2$ . This fact implies that all reduced partial differential equations in  $(PDES)_1$  are the same as those of reduced equations in  $(PDES)_2$ .  $\square$

**Corollary 3.9** *Let (PDES) be a system of partial differential equations of first order in  $\mathbb{R}^n$ ,  $[A]_{n \times n}$  an orthogonal matrix and  $h = [A]_{n \times n}(x_1, x_2, \dots, x_n)^T$ . Then  $(PDES)^h \stackrel{\theta}{\sim} (PDES)$ .*

For example, let  $h$  be a linear transformation on  $\mathbb{R}^2$  determined by

$$\begin{cases} x_1 = ax + by \\ y_1 = -bx + ay \end{cases}$$

with  $a^2 + b^2 = 1$ ,  $a, b \in \mathbb{R}$ . Then

$$\begin{cases} \frac{\partial u}{\partial x} = a \frac{\partial u}{\partial x_1} - b \frac{\partial u}{\partial y_1} \\ \frac{\partial u}{\partial y} = b \frac{\partial u}{\partial x_1} + a \frac{\partial u}{\partial y_1}. \end{cases}$$

Thus, the equation

$$\frac{\partial u}{\partial x} + \frac{\partial u}{\partial y} = 0$$

is isometric to

$$(a+b) \frac{\partial u}{\partial x} + (a-b) \frac{\partial u}{\partial y} = 0$$

since  $G$ -solution of them is  $K_2$  with labels transformed by  $h$  each other.

## §4. Characterizing $G$ -Solutions

### 4.1 Global Stability of $G$ -Solutions

Denoted a solution  $u(x_1, x_2, \dots, x_n)$  by  $u(x_1, x_2, \dots, x_{n-1}, t)$  and  $G$ -solution,  $G_0$ -solution by  $G[t]$ -solution,  $G[0]$ -solution in this section. We discuss the global stability of  $G(t)$ -solutions of partial differential equation systems of first order, i.e., *sum-stability* and *prod-stability* following.

**Definition 4.1** *Let  $(PDES_m^C)$  be a Cauchy problem on a system of partial differential equations of first order in  $\mathbb{R}^n$ , and  $u^{[v]}$  the solution of the  $v$ th equation with initial value  $u_0^{[v]}$ . Then*

(1) *The system  $(PDES_m^C)$  is sum-stable if for any number  $\varepsilon > 0$  there exists  $\delta_v > 0$ ,  $v \in V(\widehat{G}[0])$  such that each  $G(t)$ -solution with*

$$\left| u_0^{[v]} - u_0^{[v]} \right| < \delta_v, \quad \forall v \in V(\widehat{G}[0])$$

*exists for all  $t \geq 0$  and with the inequality*

$$\left| \sum_{v \in V(\widehat{G}[t])} u^{[v]} - \sum_{v \in V(\widehat{G}[t])} u^{[v]} \right| < \varepsilon$$

*holds, denoted by  $G[t] \stackrel{\Sigma}{\sim} G[0]$ . Furthermore, if there exists a number  $\beta_v > 0$ ,  $v \in V(\widehat{G}[0])$  such*

that every  $G'[t]$ -solution with

$$\left| u'_0{}^{[v]} - u_0^{[v]} \right| < \beta_v, \quad \forall v \in V(\widehat{G}[0])$$

satisfies

$$\lim_{t \rightarrow \infty} \left| \sum_{v \in V(\widehat{G}[t])} u'^{[v]} - \sum_{v \in V(\widehat{G}[t])} u^{[v]} \right| = 0,$$

then the  $G[t]$ -solution is called asymptotically stable, denoted by  $G[t] \xrightarrow{\Sigma} G[0]$ .

(2) The system  $(PDES_m^C)$  is prod-stable if for any number  $\varepsilon > 0$  there exists  $\delta_v > 0$ ,  $v \in V(\widehat{G}[0])$  such that each  $G(t)$ -solution with

$$\left| u'_0{}^{[v]} - u_0^{[v]} \right| < \delta_v, \quad \forall v \in V(\widehat{G}[0])$$

exists for all  $t \geq 0$  and with the inequality

$$\left| \prod_{v \in V(\widehat{G}[t])} u'^{[v]} - \prod_{v \in V(\widehat{G}[t])} u^{[v]} \right| < \varepsilon$$

holds, denoted by  $G[t] \xrightarrow{\Pi} G[0]$ . Furthermore, if there exists a number  $\beta_v > 0$ ,  $v \in V(G[t])$  such that every  $G'[t]$ -solution with

$$\left| u'_0{}^{[v]} - u_0^{[v]} \right| < \beta_v, \quad \forall v \in V(\widehat{G}[0])$$

satisfies

$$\lim_{t \rightarrow \infty} \left| \prod_{v \in V(\widehat{G}[t])} u'^{[v]} - \prod_{v \in V(\widehat{G}[t])} u^{[v]} \right| = 0,$$

Then the  $G[t]$ -solution is called asymptotically prod-stable, denoted by  $G[t] \xrightarrow{\Pi} G[0]$ .

Denote by  $\ln G[t]$  such a  $G[t]$ -solution replaced  $u^{[v]}$  by  $\ln u^{[v]}$  for  $\forall v \in V(G[t])$ . The following result follows immediately from the definition of sum and prod-stability of  $G[t]$ -solution.

**Theorem 4.2** Let  $(PDES_m^C)$  be a Cauchy problem of partial differential equations of first order in  $\mathbb{R}^n$ . Then

(1)  $G[t] \xrightarrow{\Pi} G[0]$  if and only if  $\ln G[t] \xrightarrow{\Sigma} \ln G[0]$ , and  $G[t] \xrightarrow{\Sigma} G[0]$  if and only if  $\ln G[t] \xrightarrow{\Pi} \ln G[0]$ .

(2) If there is a permutation  $\pi$  action on  $V(G[t])$  such that

$$\left| v'_0{}^{[v]} - u_0^{[v]} \right| < \delta_v, \quad \forall v \in V(\widehat{G}[0])$$

exists with the inequality

$$\left| u'^{[v]} - u^{[v^\pi]} \right| < \varepsilon$$



holds for  $\forall v \in V(G[t])$ , then  $G[t] \stackrel{\Sigma}{\approx} G[0]$ . Furthermore, if there exists a number  $\beta_v > 0$ ,  $v \in V(\widehat{G}[0])$  such that every  $G'[t]$ -solution with

$$\left| u_0^{[v]} - u_0^{[v]} \right| < \beta_v, \quad \forall v \in V(\widehat{G}[0])$$

satisfies

$$\lim_{t \rightarrow \infty} \left| u^{[v]} - u^{[v^\pi]} \right| = 0,$$

then  $G[t] \stackrel{\Sigma}{\approx} G[0]$ . Particularly, if  $u^{[v]}$  is stable or asymptotically stable for  $\forall v \in V(G[t])$ , then  $G[t] \stackrel{\Sigma}{\approx} G[0]$  or  $G[t] \stackrel{\Sigma}{\approx} G[0]$

*Proof* Notice that

$$\ln \left| \prod_{v \in V(\widehat{G}[0])} u^{[v]} \right| = \sum_{v \in V(\widehat{G}[0])} \ln |u^{[v]}|$$

and if a  $G[t]$ -solution is prod-stable or asymptotically prod-stable, its  $G'[t]$ -solution replacing some  $u^{[v]}$  by  $-u^{[v]}$  is also prod-stable or asymptotically prod-stable, we get the conclusion (1).

For any permutation  $\pi$  on  $V(G[t])$ , it is clear that

$$\sum_{v \in V(G[t])} u^{[v^\pi]} = \sum_{v \in V(G[t])} u^{[v]},$$

which implies the conclusion (2) by definition.  $\square$

Notice that the characteristic system of the  $i$ th equation in  $(PDES_m)$  is

$$\begin{aligned} \frac{dx_1}{F_{kp_1}} &= \frac{dx_2}{F_{kp_2}} = \dots = \frac{dx_n}{F_{kp_n}} = \frac{du}{\sum_{i=1}^n p_i F_{kp_i}} \\ &= -\frac{dp_1}{F_{kx_1} + p_1 F_{ku}} = \dots = -\frac{dp_n}{F_{kx_n} + p_n F_{ku}} = dt. \end{aligned}$$

Whence, the sum and prod-stability of Cauchy problem  $(PDES_m^C)$  are equivalent to that of the ordinary differential equations consisting of all characteristic systems of partial differential equations in  $(PDES_m^C)$  with the same initial values. Particularly, let the system  $(PDES_m^C)$  be

$$\left. \begin{aligned} \frac{\partial u}{\partial t} &= H_i(t, x_1, \dots, x_{n-1}, p_1, \dots, p_{n-1}) \\ u|_{t=t_0} &= u_0^{[i]}(x_1, x_2, \dots, x_{n-1}) \end{aligned} \right\} 1 \leq i \leq m \quad (APDES_m^C)$$

A point  $X_0^{[i]} = (t_0, x_{10}^{[i]}, \dots, x_{(n-1)0}^{[i]})$  with  $H_i(t_0, x_{10}^{[i]}, \dots, x_{(n-1)0}^{[i]}) = 0$  for an integer  $1 \leq i \leq m$  is called an *equilibrium point* of the  $i$ th equation in  $(APDES_m)$ . Then a result on the global stability of  $(APDES_m)$  is found in the following.

**Theorem 4.3** Let  $X_0^{[i]}$  be an equilibrium point of the  $i$ th equation in  $(APDES_m^C)$ ,

$$X_0^\Sigma = \sum_{i=1}^m X_0^{[i]}, \quad X^\Sigma(G[t]) = \sum_{v \in V(\widehat{G}[0])} X_v(t),$$

$$X_0^\Pi = \prod_{i=1}^m X_0^{[i]}, \quad X^\Pi(G[t]) = \prod_{v \in V(\widehat{G}[0])} X_v(t)$$

and  $L : \mathcal{O} \subset \mathbb{R}^n \rightarrow \mathbb{R}$  a differentiable function on an open set  $\mathcal{O} \subset \mathbb{R}^n$  containing  $X_0^\Sigma$  and  $X_0^\Pi$ .  
If

$$L(X^\Sigma(G[t])) > 0 \quad \text{and} \quad \dot{L}(X^\Sigma(G[t])) \leq 0$$

for  $X \in \mathcal{O} - X_0^\Sigma$ , the system  $(APDES_m^C)$  is sum-stability, i.e.,  $G[t] \xrightarrow{\Sigma} G[0]$ . Furthermore, if

$$\dot{L}(X^\Sigma(G[t])) < 0$$

for  $X \in \mathcal{O} - X_0^\Sigma$ , then  $G[t] \xrightarrow{\Sigma} G[0]$ .

Similarly, if

$$L(X^\Pi(G[t])) > 0 \quad \text{and} \quad \dot{L}(X^\Pi(G[t])) \leq 0$$

for  $X \in \mathcal{O} - X_0^\Pi$ , the system  $(APDES_m^C)$  is prod-stability, i.e.,  $G[t] \xrightarrow{\Pi} G[0]$ . Furthermore, if

$$\dot{L}(X^\Pi(G[t])) < 0$$

for  $X \in \mathcal{O} - X_0^\Pi$ , then  $G[t] \xrightarrow{\Pi} G[0]$ .

*Proof* Let  $\epsilon > 0$  be a so small number that the closed ball  $B_\epsilon(X_0^\Sigma)$  centered at  $X_0^\Sigma$  with radius  $\epsilon$  entirely lies in  $\mathcal{O}$  and let  $\Lambda_0$  be the minimum value of  $L(X^\Sigma(G[t]))$  on the boundary of  $B_\epsilon(X_0^\Sigma)$ , i.e., the sphere  $S_\epsilon(X_0^\Sigma)$ . Clearly,  $\Lambda_0 > 0$  by assumption. Define  $U = \{X \in B_\epsilon(X_0^\Sigma) | L(X) < \Lambda_0\}$ . Notice that  $X_0^\Sigma \in U$  and  $L$  is non-increasing on  $(X^\Sigma(G[t]))$  by definition in  $\mathcal{O} - X_0^\Sigma$ . There are no solutions  $X_v(t)$ ,  $v \in V(\widehat{G}[0])$  starting in  $U$  such that  $L(X^\Sigma(G[t]))$  meet the sphere  $S_\epsilon(X_0^\Sigma)$  because of the decrease of  $L(X^\Sigma(G[t]))$ . Thus all solutions  $X_v(t)$ ,  $v \in V(\widehat{G}[0])$  starting in  $U$  enable  $L(X^\Sigma(G[t]))$  included in ball  $B_\epsilon(X_0^\Sigma)$ . Consequently,  $G[t] \xrightarrow{\Sigma} G[0]$  by definition.

Now assume that  $\dot{L}(X^\Sigma(G[t])) < 0$  for  $X^\Sigma(G[t]) \neq X_0^\Sigma$ . Thus  $L$  is strictly decreasing on  $X^\Sigma(G[t])$  in  $\mathcal{O} - X_0^\Sigma$ . If  $X_v(t_n)$ ,  $v \in V(\widehat{G}[0])$  are all solutions of  $(APDES_m^C)$  starting in  $U - X_0^\Sigma$  such that  $X^\Sigma(G[t_n]) \rightarrow Y_0$  for  $n \rightarrow \infty$  with  $Y_0 \in B_\epsilon(X_0^\Sigma)$ , then it must be  $Y_0 = X_0^\Sigma$ . Otherwise, since  $L(X^\Sigma(G[t_n])) > L(Y_0)$  by the assumption  $\dot{L}(X^\Sigma(G[t])) < 0$  for  $X^\Sigma(G[t]) \in \mathcal{O} - X_0^\Sigma$  and  $L(X^\Sigma(G[t])) \rightarrow L(Y_0)$  for  $n \rightarrow \infty$  by the continuity of  $L$ , if  $Y_0 \neq X_0^\Sigma$ , let  $Y_v(t)$ ,  $v \in V(\widehat{G}[0])$  be the solutions starting at  $Y_0$ . Then for any  $\eta > 0$ ,

$$L\left(\sum_{v \in V(\widehat{G}[0])} Y_v(\eta)\right) < L(Y_0).$$

But then a contradiction

$$L \left( \sum_{v \in V(\tilde{G}[0])} X_v(t_n + \eta) \right) < L(Y_0)$$

yields by letting  $Y_0 = X^\Sigma(G[t_n])$  for sufficiently large  $n$ . So there must be  $Y_0 = X_0^\Sigma$ . Thus  $G[t] \xrightarrow{\Sigma} G[0]$ .

It should be noted that by replacing  $X_0^\Sigma, X^\Sigma(G[t])$  by  $X_0^\Pi, X^\Pi(G[t])$  and  $B_\epsilon(X_0^\Sigma)$  by  $B_\epsilon(X_0^\Pi)$  in the previous discussion, the conclusion is also hold, which enables one to know that  $G[t] \xrightarrow{\Pi} G[0]$  or  $G[t] \xrightarrow{\Pi} G[0]$ . This completes the proof.  $\square$

According to Theorem 4.3, if we find a differential function  $L : \mathcal{O} \subset \mathbb{R}^n \rightarrow \mathbb{R}$ , then we are easily known the sum or prod-stability of  $(APDES_m^C)$ . Calculation shows that the characteristic system of the  $i$ th equation in  $(APDES_m)$  is

$$dt = \frac{dx_1}{\frac{\partial H_i}{\partial p_1}} = \cdots = \frac{dx_{n-1}}{\frac{\partial H_i}{\partial p_{n-1}}} = -\frac{dp_1}{\frac{\partial H_i}{\partial x_1}} = \cdots = -\frac{dp_{n-1}}{\frac{\partial H_i}{\partial x_{n-1}}} = \frac{du}{\sum_{l=0}^{n-1} p_l \frac{\partial H_i}{\partial p_l} + \frac{\partial u}{\partial t}}$$

and

$$\frac{dx_l}{dt} = \frac{\partial H_i}{\partial p_l}, \quad \frac{dp_l}{dt} = -\frac{\partial H_i}{\partial x_l}.$$

for integers  $1 \leq i \leq m$ ,  $1 \leq l \leq n-1$ . Whence,

$$\begin{aligned} \frac{dH_i}{dt} &= \frac{\partial H_i}{\partial t} + \sum_{l=1}^{n-1} \frac{\partial H_i}{\partial x_l} \frac{dx_l}{dt} + \sum_{l=1}^{n-1} \frac{\partial H_i}{\partial p_l} \frac{dp_l}{dt} \\ &= \frac{\partial H_i}{\partial t} + \sum_{l=1}^{n-1} \frac{\partial H_i}{\partial x_l} \frac{\partial H_i}{\partial p_l} - \sum_{l=1}^{n-1} \frac{\partial H_i}{\partial p_l} \frac{\partial H_i}{\partial x_l} \equiv \frac{\partial H_i}{\partial t} \end{aligned}$$

for integers  $1 \leq i \leq m$ . This fact enables us to find conditions for the global stability of partial differential systems  $(APDES_m^C)$ .

**Theorem 4.4** Let  $X_0^{[i]}$  be an equilibrium point of the  $i$ th equation in  $(APDES_m)$  for each integer  $1 \leq i \leq m$ . If

$$\sum_{i=1}^m H_i(X) > 0 \quad \text{and} \quad \sum_{i=1}^m \frac{\partial H_i}{\partial t} \leq 0$$

for  $X \neq \sum_{i=1}^m X_0^{[i]}$ , then the system  $(APDES_m)$  is sum-stability, i.e.,  $G[t] \xrightarrow{\Sigma} G[0]$ . Furthermore, if

$$\sum_{i=1}^m \frac{\partial H_i}{\partial t} < 0$$

for  $X \neq \sum_{i=1}^m X_0^{[i]}$ , then  $G[t] \xrightarrow{\Sigma} G[0]$ .

Similarly, if

$$\prod_{i=1}^m H_i(X) > 0 \quad \text{and} \quad \sum_{i=1}^m \frac{1}{H_i(X)} \frac{\partial H_i}{\partial t} \leq 0$$

for  $X \neq \prod_{i=1}^m X_0^{[i]}$ , then  $G[t] \stackrel{\Pi}{\approx} G[0]$ . Furthermore, if

$$\sum_{i=1}^m \frac{1}{H_i(X)} \frac{\partial H_i}{\partial t} < 0$$

for  $X \neq \prod_{i=1}^m X_0^{[i]}$ , then  $G[t] \stackrel{\Pi}{\rightarrow} G[0]$ .

*Proof* Define  $L(X) = \sum_{i=1}^m H_i(X)$ . Then  $\dot{L}(X) = \sum_{i=1}^m \dot{H}_i(X)$ . By assumption, if

$$\sum_{i=1}^m H_i(X) > 0, \quad \sum_{i=1}^m \frac{\partial H_i}{\partial t} \leq 0 \quad \text{or} \quad \sum_{i=1}^m \frac{\partial H_i}{\partial t} < 0,$$

we know that

$$L(X) > 0, \quad \dot{L}(X) \leq 0 \quad \text{or} \quad \dot{L}(X) < 0$$

for  $X \neq \prod_{i=1}^m X_0^{[i]}$ . Applying Theorem 4.3, we get that  $G[t] \stackrel{\Sigma}{\approx} G[0]$ , or furthermore,  $G[t] \stackrel{\Sigma}{\rightarrow} G[0]$  if  $\sum_{i=1}^m \frac{\partial H_i}{\partial t} < 0$ . Thus we get the sum-stability of  $G[t]$ -solution of  $(APDES_m^C)$ .

For the prod-stability of  $G[t]$ -solution of  $(APDES_m^C)$ , let  $L(X) = \prod_{i=1}^m H_i(X)$ . Then

$$\dot{L}(X) = \sum_{j=1}^m \frac{\dot{H}_j(X) \prod_{i=1}^m H_i(X)}{H_j(X)} = \prod_{i=1}^m H_i(X) \left( \sum_{j=1}^m \frac{\dot{H}_j(X)}{H_j(X)} \right).$$

Whence, if

$$\prod_{i=1}^m H_i(X) > 0, \quad \sum_{i=1}^m \frac{1}{H_i(X)} \frac{\partial H_i}{\partial t} \leq 0 \quad \text{or} \quad \sum_{i=1}^m \frac{1}{H_i(X)} \frac{\partial H_i}{\partial t} < 0$$

for integers  $1 \leq i \leq m$ , then

$$L(X) > 0, \quad \dot{L}(X) \leq 0 \quad \text{or} \quad \dot{L}(X) < 0$$

for  $X \neq \prod_{i=1}^m X_0^{[i]}$ . Applying Theorem 4.3, we know that  $G[t] \stackrel{\Pi}{\approx} G[0]$ , or furthermore,  $G[t] \stackrel{\Pi}{\rightarrow} G[0]$  if

$$\sum_{i=1}^m \frac{1}{H_i(X)} \frac{\partial H_i}{\partial t} < 0.$$

for  $X \neq \prod_{i=1}^m X_0^{[i]}$ . □

**Corollary 4.5** *An equilibrium point  $X^*$  of the Cauchy problem*

$$\begin{cases} \frac{\partial u}{\partial t} = H(t, x_1, \dots, x_{n-1}, p_1, \dots, p_{n-1}) \\ u|_{t=t_0} = u_0(x_1, x_2, \dots, x_{n-1}) \end{cases}$$

*is stable if  $H(X) > 0$ ,  $\frac{\partial H}{\partial t} \leq 0$ , and is asymptotically stable if  $\frac{\partial H}{\partial t} \leq 0$  for  $X \neq X^*$ .*

Let us see a simple example in the following.

**Example 4.6** Let  $(APDES_m^C)$  be

$$\begin{cases} \frac{\partial u}{\partial t} = H_1(t, x) = x^2 e^{-t+x} \\ u|_{t=0} = \varphi(x), \end{cases} \quad \begin{cases} \frac{\partial u}{\partial t} = H_2(t, x) = x^4 e^{-5t+x^2} \\ u|_{t=0} = \zeta(x). \end{cases}$$

Clearly,  $(t, 0)$  is its an equilibrium point. Calculation shows that

$$\begin{aligned} H_1(t, x) + H_2(t, x) &= x^2 e^{-t+x} + x^4 e^{-5t+x^2} > 0, \\ \dot{H}_1(t, x) + \dot{H}_2(t, x) &= -x^2 e^{-t+x} - 5x^4 e^{-5t+x^2} < 0 \end{aligned}$$

and

$$\begin{aligned} H_1(t, x)H_2(t, x) &= x^6 e^{-6t+x+x^2} > 0, \\ H_1 \dot{H}_2(t, x) &= -6x^6 e^{-6t+x+x^2} < 0 \end{aligned}$$

if  $x \neq 0$ . Thus the equilibrium point  $(t, 0)$  of  $(APDES_m^C)$  is both sum and prod-stable by Theorem 4.4.

## 4.2 Energy Integral of $G$ -Solution

**Definition 4.7** *Let  $G[t]$  be the  $G$ -solution of Cauchy problem  $(APDES_m^C)$ . The  $v$ -energy  $E(v[t])$  and  $G$ -energy  $E(G[t])$  are defined respectively by*

$$E(v[t]) = \int_{\mathcal{O}_v} \left( \frac{\partial u^{[v]}}{\partial t} \right)^2 dx_1 dx_2 \cdots dx_{n-1},$$

where  $\mathcal{O}_v \subset \mathbb{R}^n$  is determined by the  $v$ th equation

$$\begin{cases} \frac{\partial u}{\partial t} = H_v(t, x_1, \dots, x_{n-1}, p_1, \dots, p_{n-1}) \\ u|_{t=t_0} = u_0^{[v]}(x_1, x_2, \dots, x_{n-1}) \end{cases}$$

and

$$E(G[t]) = \sum_{G \leq \widehat{G}[0]} (-1)^{|G|+1} \int_{\mathcal{O}_G} \left( \frac{\partial u^G}{\partial t} \right)^2 dx_1 dx_2 \cdots dx_{n-1},$$

where  $u^G$  is the  $C^2$  solution of system

$$\left. \begin{aligned} \frac{\partial u}{\partial t} &= H_v(t, x_1, \cdots, x_{n-1}, p_1, \cdots, p_{n-1}) \\ u|_{t=t_0} &= u_0^{[v]}(x_1, x_2, \cdots, x_{n-1}) \end{aligned} \right\} v \in V(G)$$

and  $\mathcal{O}_G = \bigcap_{v \in V(G)} \mathcal{O}_v$ . Particularly, if  $\widehat{G}[0] \simeq \overline{K}_n$ , i.e., all equations in  $(APDES_m^C)$  is non-solvable two by two, then

$$E(G[t]) = \sum_{v \in \widehat{G}[0]} \int_{\mathcal{O}_v} \left( \frac{\partial u^v}{\partial t} \right)^2 dx_1 dx_2 \cdots dx_{n-1} = \sum_{v \in \widehat{G}[0]} E(v[t]).$$

We determine the non-empty domain  $\mathcal{O}_G \subset \mathbb{R}^n$  in the following.

**Theorem 4.8** Let the Cauchy problem be  $(APDES_m^C)$ ,  $G \subset \widehat{G}[0]$  with  $\mathcal{O}_G \neq \emptyset$ . Then

$$\bigcap_{v \in V(G)} \mathcal{O}_v = \{X \in \mathbb{R}^n | H_u(X) = H_v(X), \forall u, v \in V(G)\}.$$

if  $|G| \geq 2$ .

*Proof* Noticing that if  $\mathcal{O}_G \neq \emptyset$ , there is a solution  $u^G$  of the system

$$\left. \begin{aligned} \frac{\partial u^G}{\partial t} &= H_v(t, x_1, \cdots, x_{n-1}, p_1, \cdots, p_{n-1}) \\ u^G|_{t=t_0} &= u_0^{[v]}(x_1, x_2, \cdots, x_{n-1}) \end{aligned} \right\} v \in V(G).$$

Whence,  $H_v = u_t^G$  for  $\forall v \in V(G)$  in  $\mathcal{O}_G$ , which implies that

$$\bigcap_{v \in V(G)} \mathcal{O}_v \subset \{X \in \mathbb{R}^n | H_v(X) = H_u(X), \forall u, v \in V(G)\}.$$

Conversely, for  $\forall X \in \{X \in \mathbb{R}^n | H_v(X) = H_u(X), \forall u, v \in V(G)\}$ , there are  $H_v(X) = H_u(X) = H(X)$  for  $\forall u, v \in V(G)$ . Thus the system

$$\frac{\partial u^G}{\partial t} = H_v(t, x_1, \cdots, x_{n-1}, p_1, \cdots, p_{n-1}), \quad v \in V(G)$$

is equivalent to the partial differential equation

$$\frac{\partial u}{\partial t} = H(t, x_1, \cdots, x_{n-1}, p_1, \cdots, p_{n-1}).$$

Now by Theorem 1.1, this equation is always solvable with suitable initial values, which means

that

$$\{X \in \mathbb{R}^n | H_v(X) = H_u(X), \forall u, v \in V(G)\} \subset \bigcap_{v \in V(G)} \mathcal{O}_v. \quad \square$$

Theorem 4.8 enables one to introduce the conception of *energy-index* for the system (APDES<sub>m</sub><sup>C</sup>) following.

**Definition 4.9** Let the Cauchy problem be (APDES<sub>m</sub><sup>C</sup>) with each  $H_i$  in  $C^2$  for integers  $1 \leq i \leq m$ . Its energy-index  $ind^E(G)$  is defined by

$$ind^E(G) = \sum_{G \leq \hat{G}[0]} (-1)^{|G|+1} \int_{\bigcap_{v \in V(G)} \mathcal{O}_v} H_G \dot{H}_G dx_1 dx_2 \cdots dx_{n-1},$$

where  $H_G = H_v$  for  $\forall v \in V(G)$  with  $\mathcal{O}_G \neq \emptyset$ .

Denoted by

$$\overline{ind}_G(v) = \int_{\bigcap_{v \in V(G)} \mathcal{O}_v} H_v \frac{\partial H_v}{\partial t} dx_1 dx_2 \cdots dx_{n-1}$$

for  $G \leq \hat{G}[0]$ . We know a result on the energy-index following.

**Theorem 4.10** Let (APDES<sub>m</sub><sup>C</sup>) be a Cauchy problem with  $G$ -solution  $G[t]$  and all  $H_i$  in  $C^2$  for integers  $1 \leq i \leq m$ . Then

$$ind^E(G) = \sum_{i=1}^m \frac{(-1)^{i+1}}{i} \sum_{v \in V(K_i), K_i \leq \hat{G}[0]} \overline{ind}_{K_i}(v).$$

*Proof* Clearly,  $\overline{ind}_G(v) = ind^E(v)$  if  $G = \langle v \rangle$  and  $\overline{ind}_G(v) = 0$  if  $G \not\leq K_s$  for some integer  $1 \leq s \leq m$ . By definition, we know that

$$\begin{aligned} ind^E(G) &= \sum_{G \leq \hat{G}[0]} (-1)^{|G|+1} \int_{\bigcap_{v \in V(G)} \mathcal{O}_v} H_G \dot{H}_G dx_1 dx_2 \cdots dx_{n-1} \\ &= \sum_{G \leq \hat{G}[0]} (-1)^{|G|+1} \int_{\bigcap_{v \in V(G)} \mathcal{O}_v} H_G \frac{\partial H_G}{\partial t} dx_1 dx_2 \cdots dx_{n-1} \\ &= \sum_{i=1}^m \sum_{K_i \leq \hat{G}[0]} (-1)^{i+1} \frac{1}{i} \sum_{v \in V(K_i)} \overline{ind}_{K_i}(v) \\ &= \sum_{i=1}^m \frac{(-1)^{i+1}}{i} \sum_{v \in V(K_i), K_i \leq \hat{G}[0]} \overline{ind}_{K_i}(v). \quad \square \end{aligned}$$

Particularly, if  $\hat{G}[0]$  is  $K_3$ -free, i.e., there are no induced subgraphs isomorphic to  $K_3$  in  $\hat{G}[0]$ , then  $\bigcap_{v \in V(K_i)} \mathcal{O}_v = \emptyset$  for integers  $i \geq 3$ . We get the following conclusion.

**Corollary 4.11** For a Cauchy problem (APDES<sub>m</sub><sup>C</sup>) with  $G$ -solution  $G[t]$ , if  $\widehat{G}[0]$  is  $K_3$ -free, then

$$\text{ind}^E(G) = \sum_{v \in V(\widehat{G}[0])} \text{ind}^E(v) - \frac{1}{2} \sum_{e \in E(\widehat{G}[0])} \int_{\mathcal{O}_u \cap \mathcal{O}_v} H_e \frac{\partial H_e}{\partial t} dx_1 dx_2 \cdots dx_{n-1},$$

where  $H_e = H_u = H_v$  for  $e = (u, v) \in E(\widehat{G}[0])$ .

Applying the energy-index  $\text{ind}^E(G)$ , we know a  $G$ -energy inequality following.

**Theorem 4.12** Let  $G[t]$  be the  $G$ -solution of Cauchy problem (APDES<sub>m</sub><sup>C</sup>). If  $\text{in}^E(G) > 0$ , then  $E(G[t_1]) > E(G[t_0])$  for  $t_1 > t_0$ .

*Proof* By definition we know that

$$\begin{aligned} E(G[t_1]) - E(G[t_0]) &= \sum_{G \leq \widehat{G}[0]} (-1)^{|G|+1} \int_{\mathcal{H}_G} \left( \frac{\partial u^G}{\partial t} \right)^2 dx_1 \cdots dx_{n-1} \Big|_{t=t_1} \\ &\quad - \sum_{G \leq \widehat{G}[0]} (-1)^{|G|+1} \int_{\mathcal{H}_G} \left( \frac{\partial u^G}{\partial t} \right)^2 dx_1 \cdots dx_{n-1} \Big|_{t=t_0} \\ &= \sum_{G \leq \widehat{G}[0]} (-1)^{|G|+1} \int_{\mathcal{H}_G} \int_{t_0}^{t_1} \frac{dH_G^2}{dt} dt dx_1 \cdots dx_{n-1} \\ &= \sum_{G \leq \widehat{G}[0]} (-1)^{|G|+1} \int_{\mathcal{H}_G} \int_{t_0}^{t_1} H_G \dot{H}_G dt dx_1 \cdots dx_{n-1} \\ &= \int_{t_0}^{t_1} \left( \sum_{G \leq \widehat{G}[0]} (-1)^{|G|+1} \int_{\mathcal{H}_G} H_G \dot{H}_G dx_1 \cdots dx_{n-1} \right) dt \\ &= \int_{t_0}^{t_1} \text{in}^G(G) dt > 0 \end{aligned}$$

if  $t_1 > t_0$ , where the interchangeable of integral orders is holden by the  $C^2$  property. Therefore,  $E(G[t_1]) > E(G[t_0])$ .  $\square$

Particularly, let  $G = \langle v \rangle$ , we get a  $v$ -energy inequality following.

**Corollary 4.13** Let  $G[t]$  be the  $G$ -solution of Cauchy problem (APDES<sub>m</sub><sup>C</sup>),  $v \in V(\widehat{G}[0])$  with  $H_v \dot{H}_v > 0$ . Then  $E(v[t_1]) > E(v[t_0])$  if  $t_1 > t_0$ .

### 4.3 Geometry of $G$ -Solution

Let  $u : \mathbb{R}^n \rightarrow \mathbb{R}^n$  be differentiable. We define its  $n$ -dimensional graph  $\Gamma[u]$  by the set of ordered pairs

$$\Gamma[u] = \{((x_1, \cdots, x_n), u(x_1, \cdots, x_n)) \mid (x_1, \cdots, x_n) \in \mathbb{R}^n\}.$$



Similarly, for a system  $(PDES_m^C)$  of partial differential equations of first order (solvable or non-solvable), its  $n$ -geometrical graph is defined by

$$\Gamma[PDES_m^C] = \{((x_1, \dots, x_n), u_v(x_1, \dots, x_n)) \mid (x_1, \dots, x_n) \in \mathbb{R}^n, v \in V(\widehat{G}[0])\}.$$

Then, a conclusion on  $\Gamma[PDES_m^C]$  can be determined in the following.

**Theorem 4.14** *Let the Cauchy problem be  $(PDES_m^C)$ . Then every connected component of  $\Gamma[PDES_m^C]$  is a differentiable  $n$ -manifold with atlas  $\mathcal{A} = \{(U_v, \phi_v) \mid v \in V(\widehat{G}[0])\}$  underlying graph  $\widehat{G}[0]$ , where  $U_v$  is the  $n$ -dimensional graph  $G[u^{[v]}] \simeq \mathbb{R}^n$  and  $\phi_v$  the projection*

$$\phi_v : ((x_1, x_2, \dots, x_n), u(x_1, x_2, \dots, x_n)) \rightarrow (x_1, x_2, \dots, x_n)$$

for  $\forall (x_1, x_2, \dots, x_n) \in \mathbb{R}^n$ .

*Proof* Clearly,  $U_v$  is open and

$$\phi_v^{-1} : (x_1, x_2, \dots, x_n) \rightarrow ((x_1, x_2, \dots, x_n), u(x_1, x_2, \dots, x_n))$$

for  $\forall v \in V(\widehat{G}[0])$ . Notice that  $u$  is differentiable in  $\mathbb{R}^n$  and  $\phi_v \phi_v^{-1} = \mathbf{1}_{U_u \cap U_v}$  and  $\phi_v \phi_u^{-1} = \mathbf{1}_{U_u \cap U_v}$  on  $U_u \cap U_v$  are also differentiable by definition of  $U_u \cap U_v$  for  $u, v \in V(\widehat{G}[0])$ . Thus the connected  $n$ -dimensional component of  $\Gamma[PDES_m^C]$  is a differential manifold.  $\square$

Notice that it is shown in [11] that manifolds can be classified by  $n$ -dimensional graphs and listed by graphs. However, Theorem 4.14 enables one to get such  $n$ -dimensional graphs for differentiable manifolds by systems  $(PDES_m^C)$  of partial differential equations. We know that the standard basis of a vector field  $T(M)$  on a differentiable  $n$ -manifold  $M$  is

$$\left\{ \frac{\partial}{\partial x_i}, 1 \leq i \leq n \right\}$$

and a vector field  $X$  can be viewed as a first order partial differential operator

$$X = \sum_{i=1}^n a_i \frac{\partial}{\partial x_i},$$

where  $a_i$  is  $C^\infty$ -differentiable for integers  $1 \leq i \leq n$ . Combining Theorems 3.6 and 4.14 enables one to get the following result on vector fields.

**Theorem 4.15** *For any integer  $m \geq 1$ , let  $U_i, 1 \leq i \leq m$  be open sets in  $\mathbb{R}^n$  underlying a connected graph defined by*

$$V(G) = \{U_i \mid 1 \leq i \leq m\}, \quad E(G) = \{(U_i, U_j) \mid U_i \cap U_j \neq \emptyset, 1 \leq i, j \leq m\}.$$

*If  $X_i$  is a vector field on  $U_i$  for integers  $1 \leq i \leq m$ , then there always exists a differentiable manifold  $M \subset \mathbb{R}^n$  with atlas  $\mathcal{A} = \{(U_i, \phi_i) \mid 1 \leq i \leq m\}$  underlying graph  $G$  and a function*

$u_G \in \Omega^0(M)$  such that

$$X_i(u_G) = 0, \quad 1 \leq i \leq m.$$

*Proof* For any integer  $1 \leq k \leq m$ , let

$$X_k = \sum_{i=1}^n a_i^{[k]} \frac{\partial}{\partial x_i}.$$

Notice that the system ( $PDES_m^C$ ) of partial differential equations

$$\left. \begin{aligned} a_1^{[v]} \frac{\partial u}{\partial x_1} + a_2^{[v]} \frac{\partial u}{\partial x_2} + \cdots + a_n^{[v]} \frac{\partial u}{\partial x_n} &= 0 \\ u|_{x_n=x_n^{[0]}} &= u_v^{[0]} \end{aligned} \right\} v \in V(G)$$

has a  $G$ -solution by Theorem 3.6. According to Theorem 4.14, its  $n$ -dimensional graph  $\Gamma[PDES_m^C]$  is an  $n$ -dimensional manifold  $M$ . We construct a differentiable function  $u_G$  on  $M$ . In fact, let  $u_v$  be a solution of the  $v$ th equation of system ( $PDES_m^C$ ) and  $\{h_v, v \in V(G)\}$  a partition of unity on open sets  $\{U_v, v \in V(G)\}$ . Define

$$u_G = \sum_{v \in V(G)} h_v u_v.$$

Then, it is clear that

$$X_k(u_G) = \sum_{i=1}^n a_i^{[k]} \frac{\partial u}{\partial x_i} = 0$$

for any integers  $1 \leq k \leq m$ . □

Generally, we can also characterize these systems of shifted partial differential equations introduced in Theorem 2.7 by that of a generalization of manifold, i.e. *differentiable combinatorial manifold* defined following.

**Definition 4.16** ([6],[10]) *Let  $n_\nu, \nu \in \Lambda$  be positive integers. A differentiable combinatorial manifold  $\widetilde{M}(n_\nu, \nu \in \Lambda)$  is a second countable Hausdorff space with a maximal atlas  $\mathcal{A} = \{(U_\nu, \phi_\nu) | \nu \in \Lambda\}$  for a countable set  $\Lambda$  such that  $\phi_\nu : U_\nu \rightarrow \mathbb{R}^{n_\nu}$ ,  $\phi_\nu \phi_\mu^{-1} : \phi_\mu(U_\mu \cap U_\nu) \rightarrow \phi_\nu(U_\mu \cap U_\nu)$  are differentiable for  $\forall \mu, \nu \in \Lambda$ .*

Clearly, a combinatorial manifold underlies a connected graph  $G[\widetilde{M}(n_\nu, \nu \in \Lambda)]$  defined by  $V(G[\widetilde{M}(n_\nu, \nu \in \Lambda)]) = \{U_\nu, \nu \in \Lambda\}$  and  $E(G[\widetilde{M}(n_\nu, \nu \in \Lambda)]) = \{(U_\mu, U_\nu) | U_\mu \cap U_\nu \neq \emptyset, \mu, \nu \in \Lambda\}$ . Particularly, if  $\Lambda$  is finite, then  $G[\widetilde{M}(n_\nu, \nu \in \Lambda)]$  is nothing but an finite connected graph., i.e., a compact  $\widetilde{M}(n_\nu, \nu \in \Lambda)$ . The following results are a generalization of Theorems 4.14 and 4.15, which can be similarly obtained.



$$H^{[k]} : (q_1, \dots, q_n, p_2, \dots, p_n, t) \rightarrow H^{[k]}(q_1, \dots, q_n, p_1, \dots, p_n, t)$$

for integers  $1 \leq k \leq m$ . Thus

$$\left. \begin{aligned} \frac{\partial H^{[k]}}{\partial p_i} &= \frac{dq_i}{dt} \\ \frac{\partial H^{[k]}}{\partial q_i} &= -\frac{dp_i}{dt}, \quad 1 \leq i \leq n \end{aligned} \right\} 1 \leq k \leq m.$$

Such an interaction system naturally underlies a graph  $G$  with

$$V(G) = \{H^{[i]} | 1 \leq i \leq m\},$$

$$E(G) = \{(H^{[i]}, H^{[j]} | H^{[i]} \text{ interacts with } H^{[j]} \text{ for integers } 1 \leq i, j \leq m\}.$$

For example, let  $m = 4$ . Then such an interaction system are shown in Fig.2. Such a system is equivalent to the system  $(APDES_m^C)$  of non-solvable partial differential equations

$$\left. \begin{aligned} \frac{\partial u}{\partial t} &= H_i(t, x_1, \dots, x_{n-1}, p_1, \dots, p_{n-1}) \\ u|_{t=t_0} &= u_0^{[k]}(x_1, x_2, \dots, x_{n-1}) \end{aligned} \right\} 1 \leq k \leq m.$$

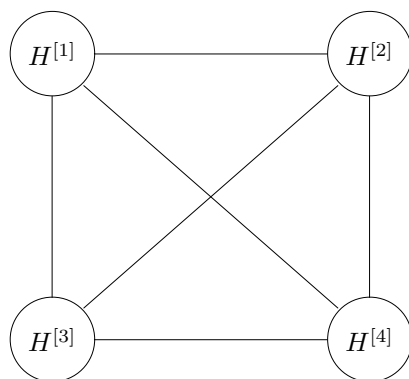

**Fig.2**

Whence, if  $X_0^{[i]}$  be an equilibrium point of the  $i$ th equation in this system,

$$\sum_{k=1}^m H^{[k]}(X) > 0 \quad \text{and} \quad \sum_{k=1}^m \frac{\partial H^{[k]}}{\partial t} \leq 0$$

for  $X \neq \sum_{k=1}^m X_0^{[k]}$ , then  $\tilde{\mathcal{F}}$  is sum-stable and furthermore, if

$$\sum_{k=1}^m \frac{\partial H^{[k]}}{\partial t} < 0$$

for  $X \neq \sum_{k=1}^m X_0^{[k]}$ , then it is also asymptotically sum-stable by Theorem 4.4.

Similarly, if

$$\prod_{k=1}^m H^{[k]}(X) > 0 \quad \text{and} \quad \sum_{k=1}^m \frac{1}{H^{[k]}(X)} \frac{\partial H^{[k]}}{\partial t} \leq 0$$

for  $X \neq \prod_{k=1}^m X_0^{[k]}$ , then  $\widetilde{\mathcal{F}}$  is prod-stable and furthermore, if

$$\sum_{k=1}^m \frac{1}{H^{[k]}(X)} \frac{\partial H^{[k]}}{\partial t} < 0$$

for  $X \neq \prod_{k=1}^m X_0^{[k]}$ , then it is also asymptotically prod-stable by Theorem 4.4. Such combinatorial fields are extensively existed in theoretical physics (See references [7], [9]-[10] for details).

### 5.2 Flows in network

Let  $N$  be a network and let  $q(x, t)$ ,  $\rho(x, t)$ ,  $u(x, t)$  be the respective rate, density and velocity of 1-dimensional flow on an arc  $(x, y)$  of  $N$  at time  $t$ . Then the continuity equation of 1-dimension enables one knowing that

$$\frac{\partial \rho}{\partial t} + \frac{\partial q}{\partial x} = 0 \quad \text{and} \quad q = \rho u.$$

Particularly, if  $u(x, t)$  depends on  $\rho(x, t)$ , the density, let  $u(x, t) = u(\rho(x, t))$ , then  $q(x, t) = \rho(x, t)u(\rho(x, t))$  and

$$\frac{\partial q}{\partial x} = \left( u + \rho \frac{\partial u}{\partial \rho} \right) \frac{\partial \rho}{\partial x} = \phi(\rho) \frac{\partial \rho}{\partial x},$$

where,  $\phi(\rho) = u + \rho \frac{\partial u}{\partial \rho}$ . Consequently,

$$\frac{\partial \rho}{\partial t} + \phi(\rho) \frac{\partial \rho}{\partial x} = 0.$$

Now let  $O$  be a node in  $N$  incident with  $m$  in-flows and 1 out-flow. Such as those shown in Fig.3.

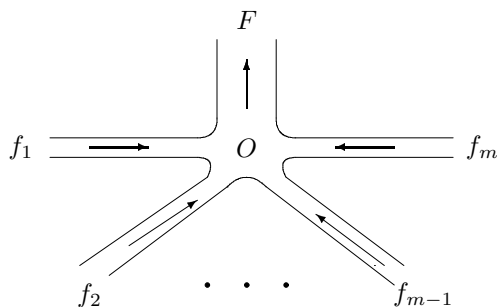

Fig.3

Then how can we characterize the behavior of flow  $F$ ? Denote the rate, density of flow  $f_i$  by

$\rho^{[i]}$  for integers  $1 \leq i \leq m$  and that of  $F$  by  $\rho^{[F]}$ , respectively. Then we know that

$$\frac{\partial \rho^{[i]}}{\partial t} + \phi_i(\rho^{[i]}) \frac{\partial \rho^{[i]}}{\partial x} = 0, \quad 1 \leq i \leq m.$$

Assume these flows  $f^{[i]}$ ,  $1 \leq i \leq m$  to be conservation at the node  $O$ . Then we know that  $\rho^{[F]} = \sum_{i=1}^m \rho^{[i]}$ . Whence,

$$\frac{\partial \rho^{[F]}}{\partial t} = \sum_{i=1}^m \frac{\partial \rho^{[i]}}{\partial t} = - \sum_{i=1}^m \phi_i(\rho^{[i]}) \frac{\partial \rho^{[i]}}{\partial x}.$$

Thus

$$\frac{\partial \rho^{[F]}}{\partial t} + \sum_{i=1}^m \phi_i(\rho^{[i]}) \frac{\partial \rho^{[i]}}{\partial x} = 0$$

by the continuity equation of 1-dimension. Generally, it is difficult to determine the behavior of flow  $F$  by this equation.

We prescribe the initial value of  $\rho^{[i]}$  by  $\rho^{[i]}(x, t_0)$  at time  $t_0$ . Replacing each  $\rho^{[i]}$  by  $\rho$  in these flow equations of  $f_i$ ,  $1 \leq i \leq m$ , we then get a non-solvable system ( $PDES_m^C$ ) of partial differential equations following.

$$\left. \begin{array}{l} \frac{\partial \rho}{\partial t} + \phi_i(\rho) \frac{\partial \rho}{\partial x} = 0 \\ \rho|_{t=t_0} = \rho^{[i]}(x, t_0) \end{array} \right\} 1 \leq i \leq m.$$

Let  $\rho_0^{[i]}$  be an equilibrium point of the  $i$ th equation, i.e.,  $\phi_i(\rho_0^{[i]}) \frac{\partial \rho_0^{[i]}}{\partial x} = 0$ . Applying Theorem 4.4, if

$$\sum_{i=1}^m \phi_i(\rho) < 0 \quad \text{and} \quad \sum_{i=1}^m \phi_i(\rho) \left[ \frac{\partial^2 \rho}{\partial t \partial x} - \phi'(\rho) \left( \frac{\partial \rho}{\partial x} \right)^2 \right] \geq 0$$

for  $X \neq \sum_{k=1}^m \rho_0^{[k]}$ , then we know that the flow  $F$  is stable and furthermore, if

$$\sum_{i=1}^m \phi_i(\rho) \left[ \frac{\partial^2 \rho}{\partial t \partial x} - \phi'(\rho) \left( \frac{\partial \rho}{\partial x} \right)^2 \right] < 0$$

for  $X \neq \sum_{k=1}^m \rho_0^{[k]}$ , then it is also asymptotically stable.

## References

- [1] R.Abraham and Marsden. *Foundation of Mechanics*(2nd edition). USA: Addison-Wesley, Reading, Mass, 1978.
- [2] V.I.Arnold, V.V.Kozlov and A.I.Neishtadt. *Mathematical Aspects of Classical and Celestial Mechanics* (third edition). USA: Springer-Verlag Berlin Heidelberg, 2006.
- [3] G.V.Demidenko, S.V.Uspenskii. *Partial Differential Equations and Systems not Solvable*

- with Respect to the Higher-Order Derivative*. New York, USA: Marcel Dekker Inc., 2003.
- [4] Fritz John. *Partial Differential Equations*(4th Edition). New York, USA: Springer-Verlag, 1982.
  - [5] H.Lewy. An example of a smooth partial differential equation without solution. *Annals of Mathematics*, 66(1957),155-158.
  - [6] Linfan Mao. Geometrical theory on combinatorial manifolds. *JP J.Geometry and Topology*, Vol.7, No.1(2007),65-114.
  - [7] Linfan Mao. Combinatorial fields - an introduction. *International J. Math. Combin.*, Vol.3, 2009, 01-22.
  - [8] Linfan Mao. Graduate Textbook in Mathematics: *Automorphism Groups of Maps, Surfaces and Smarandache Geometries* (Second edition). USA: The Education Publisher Inc. 2011.
  - [9] Linfan Mao. Graduate Textbook in Mathematics: *Smarandache Multi-Space Theory* (Second edition). USA: The Education Publisher Inc. 2011.
  - [10] Linfan Mao. Graduate Textbook in Mathematics: *Combinatorial Geometry with Applications to Field Theory* (Second edition). USA: The Education Publisher Inc. 2011.
  - [11] Linfan Mao. Graph structure of manifolds with listing. *International J.Contemp. Math. Science*, Vol.5, 2011, No.2, 71-85.
  - [12] Linfan Mao. Non-solvable spaces of linear equation systems. *International J. Math. Combin.*, Vol.2 (2012), 9-23.
  - [13] Linfan Mao. Global stability of non-solvable ordinary differential equations with applications. *International J.Math. Combin.*, Vol.1 (2013), 1-37.
  - [14] R.Rubinstein. Examples of non-solvable partial differential equations. *Trans. Amer.Math.Soc.*, 199(1974), 123-129.
  - [15] M.Renardy, R.C.Rogers. *An Introduction to Partial Differential Equations*(2th Edition). Berlin Heidelberg, USA: Springer-Verlag, 2004.
  - [16] F.Smarandache, Mixed noneuclidean geometries, *eprint arXiv: math/0010119*, 10/2000.

## Geometry on Non-Solvable Equations

– *A Review on Contradictory Systems*

**Abstract:** As we known, an objective thing not moves with one's volition, which implies that all contradictions, particularly, in these semiotic systems for things are artificial. In classical view, a contradictory system is meaningless, contrast to that of geometry on figures of things caught by eyes of human beings. The main objective of sciences is holding the global behavior of things, which needs one knowing both of compatible and contradictory systems on things. Usually, a mathematical system including contradictions is said to be a *Smarandache system*. Beginning from a famous fable, i.e., the 6 blind men with an elephant, this report shows the geometry on contradictory systems, including non-solvable algebraic linear or homogenous equations, non-solvable ordinary differential equations and non-solvable partial differential equations, classify such systems and characterize their global behaviors by combinatorial geometry, particularly, the global stability of non-solvable differential equations. Applications of such systems to other sciences, such as those of gravitational fields, ecologically industrial systems can be also found in this report. All of these discussions show that a non-solvable system is nothing else but a system underlying a topological graph  $G \not\cong K_n$ , or  $\simeq K_n$  without common intersection, contrast to those of solvable systems underlying  $K_n$  being with common non-empty intersections, where  $n$  is the number of equations in this system. However, if we stand on a geometrical viewpoint, they are compatible and both of them are meaningful for human beings.

**Key Words:** Smarandache system, non-solvable system of equations, topological graph,  $G^L$ -solution, global stability, ecologically industrial systems, gravitational field, mathematical combinatorics.

**AMS(2010):** 03A10,05C15,20A05, 34A26,35A01,51A05,51D20,53A35

### §1. Introduction

A *contradiction* is a difference between two statements, beliefs, or ideas about something that can not both be true, exists everywhere and usually with a presentation as argument, debate, disputing,  $\dots$ , etc., even break out a war sometimes. Among them, a widely known contradiction in philosophy happened in a famous fable, i.e., the 6 blind men with an elephant in following. In this fable, there are 6 blind men were asked to determine what an elephant looked like by feeling different parts of the elephant's body. The man touched the elephant's leg, tail, trunk, ear, belly or tusk respectively claims it's like a pillar, a rope, a tree branch, a hand fan,

---

<sup>1</sup>An inverted talk in the *International Conference on Geometry and Its Applications*, Jardpour University, October 16-18, 2014, Kolkata, India.

<sup>2</sup>*International J.Math. Combin.* Vol.4(2014), 18-38.



a wall or a solid pipe, such as those shown in Fig.1.

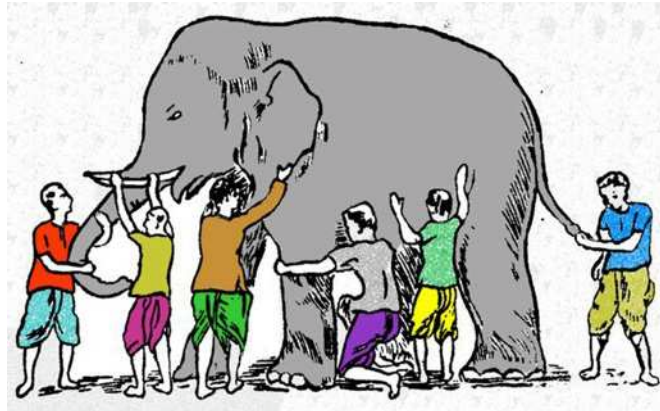

Fig.1

Each of them insisted on his own and not accepted others. They then entered into an endless argument. *All of you are right!* A wise man explains to them: *why are you telling it differently is because each one of you touched the different part of the elephant. So, actually the elephant has all those features what you all said.* Thus, the best result on an elephant for these blind men is

$$\begin{aligned} \text{An elephant} = & \{4 \text{ pillars}\} \cup \{1 \text{ rope}\} \cup \{1 \text{ tree branch}\} \\ & \cup \{2 \text{ hand fans}\} \cup \{1 \text{ wall}\} \cup \{1 \text{ solid pipe}\}, \end{aligned}$$

i.e., a *Smarandache multi-space* ([23]-[25]) defined following.

**Definition 1.1**([12]-[13]) *Let  $(\Sigma_1; \mathcal{R}_1), (\Sigma_2; \mathcal{R}_2), \dots, (\Sigma_m; \mathcal{R}_m)$  be  $m$  mathematical systems, different two by two. A Smarandache multisystem  $\tilde{\Sigma}$  is a union  $\bigcup_{i=1}^m \Sigma_i$  with rules  $\tilde{\mathcal{R}} = \bigcup_{i=1}^m \mathcal{R}_i$  on  $\tilde{\Sigma}$ , denoted by  $(\tilde{\Sigma}; \tilde{\mathcal{R}})$ .*

Then, what is the philosophical meaning of this fable for one understanding the world? In fact, the situation for one realizing behaviors of things is analogous to the blind men determining what an elephant looks like. Thus, this fable means the limitation or unilateral of one's knowledge, i.e., *science* because of all of those are just correspondent with the sensory cognition of human beings.

Besides, we know that contradiction exists everywhere by this fable, which comes from the limitation of unilateral sensory cognition, i.e., artificial contradiction of human beings, and all scientific conclusions are nothing else but an approximation for things. For example, let  $\mu_1, \mu_2, \dots, \mu_n$  be known and  $\nu_i, i \geq 1$  unknown characters at time  $t$  for a thing  $T$ . Then, the

thing  $T$  should be understood by

$$T = \left( \bigcup_{i=1}^n \{\mu_i\} \right) \cup \left( \bigcup_{k \geq 1} \{\nu_k\} \right)$$

in logic but with an approximation  $T^\circ = \bigcup_{i=1}^n \{\mu_i\}$  for  $T$  by human being at time  $t$ . Even for  $T^\circ$ , these are maybe contradictions in characters  $\mu_1, \mu_2, \dots, \mu_n$  with endless argument between researchers, such as those implied in the fable of 6 blind men with an elephant. Consequently, if one stands still on systems without contradictions, he will never hold the real face of things in the world, particularly, the true essence of geometry for limited of his time.

However, all things are inherently related, not isolated in philosophy, i.e., underlying an invariant topological structure  $G$  ([4],[22]). Thus, one needs to characterize those things on contradictory systems, particularly, by geometry. The main objective of this report is to discuss the geometry on contradictory systems, including non-solvable algebraic equations, non-solvable ordinary or partial differential equations, classify such systems and characterize their global behaviors by combinatorial geometry, particularly, the global stability of non-solvable differential equations. For terminologies and notations not mentioned here, we follow references [11], [13] for topological graphs, [3]-[4] for topology, [12],[23]-[25] for Smarandache multi-spaces and [2],[26] for partial or ordinary differential equations.

## §2. Geometry on Non-Solvable Equations

Loosely speaking, a geometry is mainly concerned with shape, size, position,  $\dots$  etc., i.e., local or global characters of a figure in space. Its mainly objective is to hold the global behavior of things. However, things are always complex, even hybrid with other things. So it is difficult to know its global characters, or true face of a thing sometimes.

Let us beginning with two systems of linear equations in 2 variables:

$$(LES_4^S) \begin{cases} x + 2y = 4 \\ 2x + y = 5 \\ x - 2y = 0 \\ 2x - y = 3 \end{cases} \quad (LES_4^N) \begin{cases} x + 2y = 2 \\ x + 2y = -2 \\ 2x - y = -2 \\ 2x - y = 2 \end{cases}$$

Clearly,  $(LES_4^S)$  is solvable with a solution  $x = 2$  and  $y = 1$ , but  $(LES_4^N)$  is not because  $x + 2y = -2$  is contradictious to  $x + 2y = 2$ , and so that for equations  $2x - y = -2$  and  $2x - y = 2$ . Thus,  $(LES_4^N)$  is a contradiction system, i.e., a Smarandache system defined following.

**Definition 2.1**([11]-[13]) *A rule in a mathematical system  $(\Sigma; \mathcal{R})$  is said to be Smarandachely denied if it behaves in at least two different ways within the same set  $\Sigma$ , i.e., validated and invalidated, or only invalidated but in multiple distinct ways.*

*A Smarandache system  $(\Sigma; \mathcal{R})$  is a mathematical system which has at least one Smarandachely denied rule in  $\mathcal{R}$ .*

In geometry, we are easily finding conditions for systems of equations solvable or not. For integers  $m, n \geq 1$ , denote by

$$S_{f_i} = \{(x_1, x_2, \dots, x_{n+1}) | f_i(x_1, x_2, \dots, x_{n+1}) = 0\} \subset \mathbb{R}^{n+1}$$

the solution-manifold in  $\mathbb{R}^{n+1}$  for integers  $1 \leq i \leq m$ , where  $f_i$  is a function hold with conditions of the implicit function theorem for  $1 \leq i \leq m$ . Clearly, the system

$$(ES_m) \left\{ \begin{array}{l} f_1(x_1, x_2, \dots, x_{n+1}) = 0 \\ \dots\dots\dots\dots\dots\dots\dots\dots\dots \\ f_m(x_1, x_2, \dots, x_{n+1}) = 0 \end{array} \right.$$

is solvable or not dependent on

$$\bigcap_{i=1}^m S_{f_i} \neq \emptyset \text{ or } = \emptyset.$$

Conversely, if  $\mathcal{D}$  is a geometrical space consisting of  $m$  manifolds  $\mathcal{D}_1, \mathcal{D}_2, \dots, \mathcal{D}_m$  in  $\mathbb{R}^{n+1}$ , where,

$$\mathcal{D}_i = \{(x_1, x_2, \dots, x_{n+1}) | f_k^{[i]}(x_1, x_2, \dots, x_{n+1}) = 0, 1 \leq k \leq m_i\} = \bigcap_{k=1}^{m_i} S_{f_k^{[i]}}.$$

Then, the system

$$\left. \begin{array}{l} f_1^{[i]}(x_1, x_2, \dots, x_{n+1}) = 0 \\ \dots\dots\dots\dots\dots\dots\dots\dots\dots \\ f_{m_i}^{[i]}(x_1, x_2, \dots, x_{n+1}) = 0 \end{array} \right\} 1 \leq i \leq m$$

is solvable or not dependent on the intersection

$$\bigcap_{i=1}^m \mathcal{D}_i \neq \emptyset \text{ or } = \emptyset.$$

Thus, we obtain the following result.

**Theorem 2.2** *If a geometrical space  $\mathcal{D}$  consists of  $m$  parts  $\mathcal{D}_1, \mathcal{D}_2, \dots, \mathcal{D}_m$ , where,  $\mathcal{D}_i = \{(x_1, x_2, \dots, x_{n+1}) | f_k^{[i]}(x_1, x_2, \dots, x_{n+1}) = 0, 1 \leq k \leq m_i\}$ , then the system  $(ES_m)$  consisting of*

$$\left. \begin{array}{l} f_1^{[i]}(x_1, x_2, \dots, x_{n+1}) = 0 \\ \dots\dots\dots\dots\dots\dots\dots\dots\dots \\ f_{m_i}^{[i]}(x_1, x_2, \dots, x_{n+1}) = 0 \end{array} \right\} 1 \leq i \leq m$$

*is non-solvable if  $\bigcap_{i=1}^m \mathcal{D}_i = \emptyset$ .*

Now, *whether is it meaningless for a contradiction system in the world?* Certainly not! As we discussed in the last section, a contradiction is artificial if such a system indeed exists in the world. The objective for human beings is not just finding contradictions, but holds behaviors of such systems. For example, although the system  $(LES_4^N)$  is contradictory, but it really exists, i.e., 4 lines in  $\mathbb{R}^2$ , such as those shown in Fig.2.

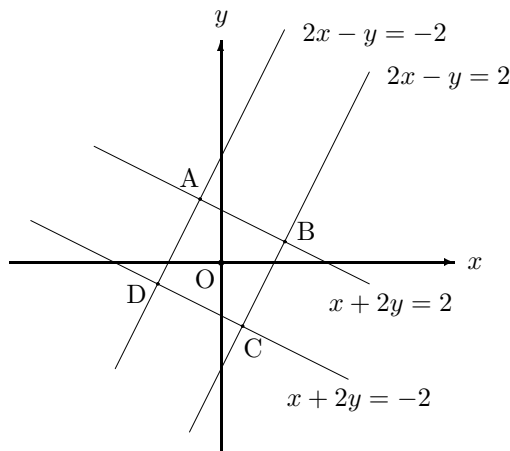

Fig.2

Generally, let

$$AX = (b_1, b_2, \dots, b_m)^T \tag{LEq}$$

be a linear equation system with

$$A = \begin{bmatrix} a_{11} & a_{12} & \cdots & a_{1n} \\ a_{21} & a_{22} & \cdots & a_{2n} \\ \cdots & \cdots & \cdots & \cdots \\ a_{m1} & a_{m2} & \cdots & a_{mn} \end{bmatrix} \quad \text{and} \quad X = \begin{bmatrix} x_1 \\ x_2 \\ \cdots \\ x_n \end{bmatrix}$$

for integers  $m, n \geq 1$ . A vertex-edge labeled graph  $G^L[LEq]$  on such a system is defined by:

$V(G^L[LEq]) = \{P_1, P_2, \dots, P_m\}$ , where  $P_i = \{(x_1, x_2, \dots, x_n) | a_{i1}x_1 + a_{i2}x_2 + \dots + a_{in}x_n = b_i\}$ ,  $E(G^L[LEq]) = \{(P_i, P_j), P_i \cap P_j \neq \emptyset, 1 \leq i, j \leq m\}$  and labeled with  $L : P_i \rightarrow P_i$ ,  $L : (P_i, P_j) \rightarrow P_i \cap P_j$  for integers  $1 \leq i, j \leq m$  with an underlying graph  $\widehat{G}[LEq]$  without labels.

For example, let  $L_1 = \{(x, y) | x + 2y = 2\}$ ,  $L_2 = \{(x, y) | x + 2y = -2\}$ ,  $L_3 = \{(x, y) | 2x - y = 2\}$  and  $L_4 = \{(x, y) | 2x - y = -2\}$  for the system  $(LES_4^N)$ . Clearly,  $L_1 \cap L_2 = \emptyset$ ,  $L_1 \cap L_3 = \{B\}$ ,  $L_1 \cap L_4 = \{A\}$ ,  $L_2 \cap L_3 = \{C\}$ ,  $L_2 \cap L_4 = \{D\}$  and  $L_3 \cap L_4 = \emptyset$ . Then, the system  $(LES_4^N)$  can also appears as a vertex-edge labeled graph  $C_4^l$  in  $\mathbb{R}^2$  with labels vertex labeling  $l(L_i) = L_i$  for integers  $1 \leq i \leq 4$ , edge labeling  $l(L_1, L_3) = B$ ,  $l(L_1, L_4) = A$ ,  $l(L_2, L_3) = C$  and

$l(L_2, L_4) = D$ , such as those shown in Fig.3.

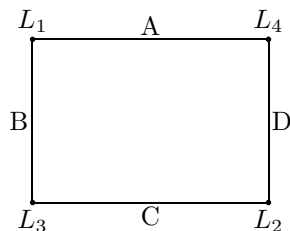

**Fig.3**

We are easily to determine  $\widehat{G}[LEq]$  for systems  $(LEq)$ . For integers  $1 \leq i, j \leq m$ ,  $i \neq j$ , two linear equations

$$\begin{aligned} a_{i1}x_1 + a_{i2}x_2 + \cdots + a_{in}x_n &= b_i, \\ a_{j1}x_1 + a_{j2}x_2 + \cdots + a_{jn}x_n &= b_j \end{aligned}$$

are called *parallel* if there exists a constant  $c$  such that

$$c = a_{j1}/a_{i1} = a_{j2}/a_{i2} = \cdots = a_{jn}/a_{in} \neq b_j/b_i.$$

Otherwise, *non-parallel*. The following result is known in [16].

**Theorem 2.3**([16]) *Let  $(LEq)$  be a linear equation system for integers  $m, n \geq 1$ . Then  $\widehat{G}[LEq] \simeq K_{n_1, n_2, \dots, n_s}$  with  $n_1 + n_2 + \cdots + n_s = m$ , where  $\mathcal{C}_i$  is the parallel family by the property that all equations in a family  $\mathcal{C}_i$  are parallel and there are no other equations parallel to lines in  $\mathcal{C}_i$  for integers  $1 \leq i \leq s$ ,  $n_i = |\mathcal{C}_i|$  for integers  $1 \leq i \leq s$  in  $(LEq)$  and  $(LEq)$  is non-solvable if  $s \geq 2$ .*

Particularly, for linear equation system on 2 variables, let  $H$  be a planar graph with edges straight segments on  $\mathbb{R}^2$ . The *c-line graph*  $L_C(H)$  on  $H$  is defined by

$$\begin{aligned} V(L_C(H)) &= \{\text{straight lines } L = e_1 e_2 \cdots e_l, l \geq 1 \text{ in } H\}; \\ E(L_C(H)) &= \{(L_1, L_2) \mid L_1 = e_1^1 e_2^1 \cdots e_l^1, L_2 = e_1^2 e_2^2 \cdots e_s^2, l, s \geq 1 \\ &\quad \text{and there adjacent edges } e_i^1, e_j^2 \text{ in } H, 1 \leq i \leq l, 1 \leq j \leq s\}. \end{aligned}$$

Then, a simple criterion in [16] following is interesting.

**Theorem 2.4**([16]) *A linear equation system  $(LEq2)$  on 2 variables is non-solvable if and only if  $\widehat{G}[LEq2] \simeq L_C(H)$ , where  $H$  is a planar graph of order  $|H| \geq 2$  on  $\mathbb{R}^2$  with each edge a straight segment*

Generally, a Smarandache multisystem is equivalent to a combinatorial system by following, which implies the *CC Conjecture* for mathematics, i.e., *any mathematics can be reconstructed from or turned into combinatorization* (see [6] for details).

**Definition 2.5**([11]-[13]) For any integer  $m \geq 1$ , let  $(\tilde{\Sigma}; \tilde{\mathcal{R}})$  be a Smarandache multisystem consisting of  $m$  mathematical systems  $(\Sigma_1; \mathcal{R}_1), (\Sigma_2; \mathcal{R}_2), \dots, (\Sigma_m; \mathcal{R}_m)$ . An inherited topological structure  $G^L[\tilde{S}]$  of  $(\tilde{\Sigma}; \tilde{\mathcal{R}})$  is a topological vertex-edge labeled graph defined following:

$$V(G^L[\tilde{S}]) = \{\Sigma_1, \Sigma_2, \dots, \Sigma_m\},$$

$$E(G^L[\tilde{S}]) = \{(\Sigma_i, \Sigma_j) \mid \Sigma_i \cap \Sigma_j \neq \emptyset, 1 \leq i \neq j \leq m\} \text{ with labeling}$$

$$L: \Sigma_i \rightarrow L(\Sigma_i) = \Sigma_i \quad \text{and} \quad L: (\Sigma_i, \Sigma_j) \rightarrow L(\Sigma_i, \Sigma_j) = \Sigma_i \cap \Sigma_j$$

for integers  $1 \leq i \neq j \leq m$ .

Therefore, a Smarandache system is equivalent to a combinatorial system, i.e.,  $(\tilde{\Sigma}; \tilde{\mathcal{R}}) \simeq G^L[\tilde{S}]$ , a labeled graph  $\hat{G}^L[\tilde{S}]$  by this notion. For examples, denoting by  $a = \{\text{tusk}\} b = \{\text{nose}\} c_1, c_2 = \{\text{ear}\} d = \{\text{head}\} e = \{\text{neck}\} f = \{\text{trunk}\} g_1, g_2, g_3, g_4 = \{\text{leg}\} h = \{\text{tail}\}$  for an elephant then a topological structure for an elephant is shown in Fig.4 following.

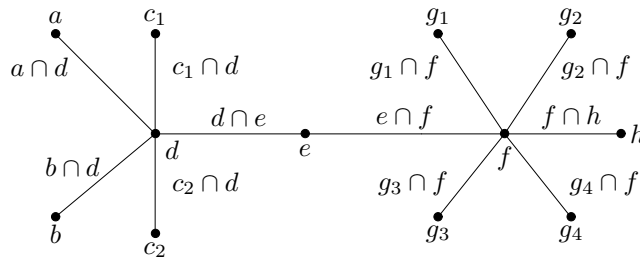

**Fig.4** Topological structure of an elephant

For geometry, let these mathematical systems  $(\Sigma_1; \mathcal{R}_1), (\Sigma_2; \mathcal{R}_2), \dots, (\Sigma_m; \mathcal{R}_m)$  be geometrical spaces, for instance manifolds  $M_1, M_2, \dots, M_m$  with respective dimensions  $n_1, n_2, \dots, n_m$  in Definition 2.3, we get a geometrical space  $\tilde{M} = \bigcup_{i=1}^m M_i$  underlying a topological graph  $G^L[\tilde{M}]$ . Such a geometrical space  $G^L[\tilde{M}]$  is said to be *combinatorial manifold*, denoted by  $\tilde{M}(n_1, n_2, \dots, n_m)$ . Particularly, if  $n_i = n, 1 \leq i \leq m$ , then a combinatorial manifold  $\tilde{M}(n_1, \dots, n_m)$  is nothing else but an  $n$ -manifold underlying  $G^L[\tilde{M}]$ . However, this presentation of  $G^L$ -systems contributes to manifolds and combinatorial manifolds (See [7]-[15] for details). For example, the fundamental groups of manifolds are characterized in [14]-[15] following.

**Theorem 2.6**([14]) For any locally compact  $n$ -manifold  $M$ , there always exists an inherent graph  $G_{min}^{in}[M]$  of  $M$  such that  $\pi(M) \cong \pi(G_{min}^{in}[M])$ .

Particularly, for an integer  $n \geq 2$  a compact  $n$ -manifold  $M$  is simply-connected if and only if  $G_{min}^{in}[M]$  is a finite tree.

**Theorem 2.7**([15]) Let  $\tilde{M}$  be a finitely combinatorial manifold. If for  $\forall(M_1, M_2) \in E(G^L[\tilde{M}])$ ,

$M_1 \cap M_2$  is simply-connected, then

$$\pi_1(\widetilde{M}) \cong \left( \bigoplus_{M \in V(G[\widetilde{M}])} \pi_1(M) \right) \oplus \pi_1(G[\widetilde{M}]).$$

Furthermore, it provides one with a listing of manifolds by graphs in [14].

**Theorem 2.8**([14]) *Let  $\mathcal{A}[M] = \{ (U_\lambda; \varphi_\lambda) \mid \lambda \in \Lambda \}$  be a atlas of a locally compact  $n$ -manifold  $M$ . Then the labeled graph  $G_{|\Lambda|}^L$  of  $M$  is a topological invariant on  $|\Lambda|$ , i.e., if  $H_{|\Lambda|}^{L_1}$  and  $G_{|\Lambda|}^{L_2}$  are two labeled  $n$ -dimensional graphs of  $M$ , then there exists a self-homeomorphism  $h : M \rightarrow M$  such that  $h : H_{|\Lambda|}^{L_1} \rightarrow G_{|\Lambda|}^{L_2}$  naturally induces an isomorphism of graph.*

For a combinatorial surface consisting of surfaces associated with homogenous polynomials in  $\mathbb{R}^3$ , we can further determine its genus. Let

$$P_1(\bar{x}), P_2(\bar{x}), \dots, P_m(\bar{x}) \tag{ES_m^{n+1}}$$

be  $m$  homogeneous polynomials in variables  $x_1, x_2, \dots, x_{n+1}$  with coefficients in  $\mathbb{C}$  and

$$\emptyset \neq S_{P_i} = \{(x_1, x_2, \dots, x_{n+1}) \mid P_i(\bar{x}) = 0\} \subset \mathbb{P}^n \mathbb{C}$$

for integers  $1 \leq i \leq m$ , which are hypersurfaces, particularly, curves if  $n = 2$  passing through the original of  $\mathbb{C}^{n+1}$ .

Similarly, parallel hypersurfaces in  $\mathbb{C}^{n+1}$  are defined following.

**Definition 2.9** *Let  $P(\bar{x}), Q(\bar{x})$  be two complex homogenous polynomials of degree  $d$  in  $n + 1$  variables and  $I(P, Q)$  the set of intersection points of  $P(\bar{x})$  with  $Q(\bar{x})$ . They are said to be parallel, denoted by  $P \parallel Q$  if  $d > 1$  and there are constants  $a, b, \dots, c$  (not all zero) such that for  $\forall \bar{x} \in I(P, Q)$ ,  $ax_1 + bx_2 + \dots + cx_{n+1} = 0$ , i.e., all intersections of  $P(\bar{x})$  with  $Q(\bar{x})$  appear at a hyperplane on  $\mathbb{P}^n \mathbb{C}$ , or  $d = 1$  with all intersections at the infinite  $x_{n+1} = 0$ . Otherwise,  $P(\bar{x})$  are not parallel to  $Q(\bar{x})$ , denoted by  $P \not\parallel Q$ .*

Then, these polynomials in  $(ES_m^{n+1})$  can be classified into families  $\mathcal{C}_1, \mathcal{C}_2, \dots, \mathcal{C}_l$  by this parallel property such that  $P_i \parallel P_j$  if  $P_i, P_j \in \mathcal{C}_k$  for an integer  $1 \leq k \leq l$ , where  $1 \leq i \neq j \leq m$  and it is maximal if each  $\mathcal{C}_i$  is maximal for integers  $1 \leq i \leq l$ , i.e., for  $\forall P \in \{P_k(\bar{x}), 1 \leq k \leq m\} \setminus \mathcal{C}_i$ , there is a polynomial  $Q(\bar{x}) \in \mathcal{C}_i$  such that  $P \not\parallel Q$ . The following result is a generalization of Theorem 2.3.

**Theorem 2.10**([19]) *Let  $n \geq 2$  be an integer. For a system  $(ES_m^{n+1})$  of homogenous polynomials with a parallel maximal classification  $\mathcal{C}_1, \mathcal{C}_2, \dots, \mathcal{C}_l$ ,*

$$\widehat{G}[ES_m^{n+1}] \leq K(\mathcal{C}_1, \mathcal{C}_2, \dots, \mathcal{C}_l)$$

and with equality holds if and only if  $P_i \parallel P_j$  and  $P_s \not\parallel P_i$  implies that  $P_s \not\parallel P_j$ , where

$K(\mathcal{C}_1, \mathcal{C}_2, \dots, \mathcal{C}_l)$  denotes a complete  $l$ -partite graphs. Conversely, for any subgraph  $G \leq K(\mathcal{C}_1, \mathcal{C}_2, \dots, \mathcal{C}_l)$ , there are systems  $(ES_m^{n+1})$  of homogenous polynomials with a parallel maximal classification  $\mathcal{C}_1, \mathcal{C}_2, \dots, \mathcal{C}_l$  such that

$$G \simeq \widehat{G}[ES_m^{n+1}].$$

Particularly, if all polynomials in  $(ES_m^{n+1})$  be degree 1, i.e., hyperplanes with a parallel maximal classification  $\mathcal{C}_1, \mathcal{C}_2, \dots, \mathcal{C}_l$ , then

$$\widehat{G}[ES_m^{n+1}] = K(\mathcal{C}_1, \mathcal{C}_2, \dots, \mathcal{C}_l).$$

The following result is immediately known by definition.

**Theorem 2.11** Let  $(ES_m^{n+1})$  be a  $G^L$ -system consisting of homogenous polynomials  $P(\bar{x}_1), P(\bar{x}_2), \dots, P(\bar{x}_m)$  in  $n+1$  variables with respectively hypersurfaces  $S_{P_i}, 1 \leq i \leq m$ . Then,  $\widetilde{M} = \bigcup_{i=1}^m S_{P_i}$  is an  $n$ -manifold underlying graph  $\widehat{G}[ES_m^{n+1}]$  in  $\mathbb{C}^{n+1}$ .

For  $n = 2$ , we can further determine the genus of surface  $\widetilde{M}$  in  $\mathbb{R}^3$  following.

**Theorem 2.12**([19]) Let  $\widetilde{S}$  be a combinatorial surface consisting of  $m$  orientable surfaces  $S_1, S_2, \dots, S_m$  underlying a topological graph  $G^L[\widetilde{S}]$  in  $\mathbb{R}^3$ . Then

$$g(\widetilde{S}) = \beta(\widehat{G}\langle\widetilde{S}\rangle) + \sum_{i=1}^m (-1)^{i+1} \sum_{\bigcap_{l=1}^i S_{k_l} \neq \emptyset} \left[ g\left(\bigcap_{l=1}^i S_{k_l}\right) - c\left(\bigcap_{l=1}^i S_{k_l}\right) + 1 \right],$$

where  $g\left(\bigcap_{l=1}^i S_{k_l}\right)$ ,  $c\left(\bigcap_{l=1}^i S_{k_l}\right)$  are respectively the genus and number of path-connected components in surface  $S_{k_1} \cap S_{k_2} \cap \dots \cap S_{k_i}$  and  $\beta(\widehat{G}\langle\widetilde{S}\rangle)$  denotes the Betti number of topological graph  $\widehat{G}\langle\widetilde{S}\rangle$ .

Notice that for a curve  $C$  determined by homogenous polynomial  $P(x, y, z)$  of degree  $d$  in  $\mathbb{P}^2\mathbf{C}$ , there is a compact connected Riemann surface  $S$  by the Noether's result such that

$$h : S - h^{-1}(\text{Sing}(C)) \rightarrow C - \text{Sing}(C)$$

is a homeomorphism with genus

$$g(S) = \frac{1}{2}(d-1)(d-2) - \sum_{p \in \text{Sing}(C)} \delta(p),$$

where  $\delta(p)$  is a positive integer associated with the singular point  $p$  in  $C$ . Furthermore, if  $\text{Sing}(C) = \emptyset$ , i.e.,  $C$  is non-singular then there is a compact connected Riemann surface  $S$  homeomorphism to  $C$  with genus  $\frac{1}{2}(d-1)(d-2)$ . By Theorem 2.12, we obtain the genus of  $\widetilde{S}$



determined by homogenous polynomials following.

**Theorem 2.13**([19]) *Let  $C_1, C_2, \dots, C_m$  be complex curves determined by homogenous polynomials  $P_1(x, y, z), P_2(x, y, z), \dots, P_m(x, y, z)$  without common component, and let*

$$R_{P_i, P_j} = \prod_{k=1}^{\deg(P_i)\deg(P_j)} (c_k^{ij}z - b_k^{ij}y)^{e_k^{ij}}, \quad \omega_{i,j} = \sum_{k=1}^{\deg(P_i)\deg(P_j)} \sum_{e_k^{ij} \neq 0} 1$$

be the resultant of  $P_i(x, y, z), P_j(x, y, z)$  for  $1 \leq i \neq j \leq m$ . Then there is an orientable surface  $\tilde{S}$  in  $\mathbb{R}^3$  of genus

$$g(\tilde{S}) = \beta(\widehat{G} \langle \tilde{C} \rangle) + \sum_{i=1}^m \left( \frac{(\deg(P_i) - 1)(\deg(P_i) - 2)}{2} - \sum_{p^i \in \text{Sing}(C_i)} \delta(p^i) \right) + \sum_{1 \leq i \neq j \leq m} (\omega_{i,j} - 1) + \sum_{i \geq 3} (-1)^i \sum_{C_{k_1} \cap \dots \cap C_{k_i} \neq \emptyset} [c(C_{k_1} \cap \dots \cap C_{k_i}) - 1]$$

with a homeomorphism  $\varphi : \tilde{S} \rightarrow \tilde{C} = \bigcup_{i=1}^m C_i$ . Furthermore, if  $C_1, C_2, \dots, C_m$  are non-singular, then

$$g(\tilde{S}) = \beta(\widehat{G} \langle \tilde{C} \rangle) + \sum_{i=1}^m \frac{(\deg(P_i) - 1)(\deg(P_i) - 2)}{2} + \sum_{1 \leq i \neq j \leq m} (\omega_{i,j} - 1) + \sum_{i \geq 3} (-1)^i \sum_{C_{k_1} \cap \dots \cap C_{k_i} \neq \emptyset} [c(C_{k_1} \cap \dots \cap C_{k_i}) - 1],$$

where

$$\delta(p^i) = \frac{1}{2} \left( I_{p^i} \left( P_i, \frac{\partial P_i}{\partial y} \right) - \nu_\phi(p^i) + |\pi^{-1}(p^i)| \right)$$

is a positive integer with a ramification index  $\nu_\phi(p^i)$  for  $p^i \in \text{Sing}(C_i), 1 \leq i \leq m$ .

Notice that  $\widehat{G} [ES_m^3] = K_m$ . We then easily get conclusions following.

**Corollary 2.14** *Let  $C_1, C_2, \dots, C_m$  be complex non-singular curves determined by homogenous polynomials  $P_1(x, y, z), P_2(x, y, z), \dots, P_m(x, y, z)$  without common component, any intersection point  $p \in I(P_i, P_j)$  with multiplicity 1 and*

$$\begin{cases} P_i(x, y, z) = 0 \\ P_j(x, y, z) = 0, \quad \forall i, j, k \in \{1, 2, \dots, m\} \\ P_k(x, y, z) = 0 \end{cases}$$

has zero-solution only. Then the genus of normalization  $\tilde{S}$  of curves  $C_1, C_2, \dots, C_m$  is

$$g(\tilde{S}) = 1 + \frac{1}{2} \times \sum_{i=1}^m \deg(P_i) (\deg(P_i) - 3) + \sum_{1 \leq i \neq j \leq m} \deg(P_i)\deg(P_j).$$





partial differential equations with initial values  $u|_{x_n=x_n^0} = u_0$  is non-solvable if and only if the system  $(LPDES_m)$  of partial differential equations is algebraically contradictory. Particularly, the Cauchy problem on a quasilinear partial differential equation is always solvable.

Similarly, for integers  $m, n \geq 1$ , let

$$\dot{X} = A_1X, \dots, \dot{X} = A_kX, \dots, \dot{X} = A_mX \tag{LDES_m^1}$$

be a linear ordinary differential equation system of first order and

$$\begin{cases} x^{(n)} + a_{11}^{[0]}x^{(n-1)} + \dots + a_{1n}^{[0]}x = 0 \\ x^{(n)} + a_{21}^{[0]}x^{(n-1)} + \dots + a_{2n}^{[0]}x = 0 \\ \dots\dots\dots \\ x^{(n)} + a_{m1}^{[0]}x^{(n-1)} + \dots + a_{mn}^{[0]}x = 0 \end{cases} \tag{LDE_m^n}$$

a linear differential equation system of order  $n$  with

$$A_k = \begin{bmatrix} a_{11}^{[k]} & a_{12}^{[k]} & \dots & a_{1n}^{[k]} \\ a_{21}^{[k]} & a_{22}^{[k]} & \dots & a_{2n}^{[k]} \\ \dots & \dots & \dots & \dots \\ a_{n1}^{[k]} & a_{n2}^{[k]} & \dots & a_{nn}^{[k]} \end{bmatrix} \quad \text{and} \quad X = \begin{bmatrix} x_1(t) \\ x_2(t) \\ \dots \\ x_n(t) \end{bmatrix}$$

where each  $a_{ij}^{[k]}$  is a real number for integers  $0 \leq k \leq m, 1 \leq i, j \leq n$ . Then it is known a criterion from [16] following.

**Theorem 3.4**([17]) *A differential equation system  $(LDES_m^1)$  is non-solvable if and only if*

$$(|A_1 - \lambda I_{n \times n}|, |A_2 - \lambda I_{n \times n}|, \dots, |A_m - \lambda I_{n \times n}|) = 1.$$

*Similarly, the differential equation system  $(LDE_m^n)$  is non-solvable if and only if*

$$(P_1(\lambda), P_2(\lambda), \dots, P_m(\lambda)) = 1,$$

where  $P_i(\lambda) = \lambda^n + a_{i1}^{[0]}\lambda^{n-1} + \dots + a_{i(n-1)}^{[0]}\lambda + a_{in}^{[0]}$  for integers  $1 \leq i \leq m$ . Particularly,  $(LDES_m^1)$  and  $(LDE_m^n)$  are always solvable.

According to Theorems 3.3 and 3.4, for systems  $(LPDES_m^C), (LDES_m^1)$  or  $(LDE_m^n)$ , there are equivalent systems  $G^L[LPDES_m^C], G^L[LDES_m^1]$  or  $G^L[LDE_m^n]$  by Definition 2.5, called  $G^L[LPDES_m^C]$ -solution,  $G^L[LDES_m^1]$ -solution or  $G^L[LDE_m^n]$ -solution of systems  $(LPDES_m^C), (LDES_m^1)$  or  $(LDE_m^n)$ , respectively. Then, we know the following conclusion from [17]-[18], [21].

**Theorem 3.5**([17]-[18],[21]) *The Cauchy problem on system  $(PDES_m)$  of partial differential equations of first order with initial values  $x_i^{[k^0]}, u_0^{[k]}, p_i^{[k^0]}, 1 \leq i \leq n$  for the  $k$ th equation in*

(PDES<sub>m</sub>), 1 ≤ k ≤ m such that

$$\frac{\partial u_0^{[k]}}{\partial s_j} - \sum_{i=0}^n p_i^{[k^0]} \frac{\partial x_i^{[k^0]}}{\partial s_j} = 0,$$

and the linear homogeneous differential equation system (LDES<sub>m</sub><sup>1</sup>) (or (LDE<sub>m</sub><sup>n</sup>)) both are uniquely G<sup>L</sup>-solvable, i.e., G<sup>L</sup>[PDES], G<sup>L</sup>[LDES<sub>m</sub><sup>1</sup>] and G<sup>L</sup>[LDE<sub>m</sub><sup>n</sup>] are uniquely determined.

For ordinary differential systems (LDES<sub>m</sub><sup>1</sup>) or (LDE<sub>m</sub><sup>n</sup>), we can further replace solution-manifolds S<sup>[k]</sup> of the kth equation in G<sup>L</sup>[LDES<sub>m</sub><sup>1</sup>] and G<sup>L</sup>[LDE<sub>m</sub><sup>n</sup>] by their solution basis B<sup>[k]</sup> = { β<sub>i</sub><sup>[k]</sup>(t)e<sup>α<sub>i</sub><sup>[k]</sup>t</sup> | 1 ≤ i ≤ n } or C<sup>[k]</sup> = { t<sup>l</sup>e<sup>λ<sub>i</sub><sup>[k]</sup>t</sup> | 1 ≤ i ≤ s, 1 ≤ l ≤ k<sub>i</sub> } because each solution-manifold of (LDES<sub>m</sub><sup>1</sup>) (or (LDE<sub>m</sub><sup>n</sup>)) is a linear space.

For example, let a system (LDE<sub>m</sub><sup>n</sup>) be

$$\begin{cases} \ddot{x} - 3\dot{x} + 2x = 0 & (1) \\ \ddot{x} - 5\dot{x} + 6x = 0 & (2) \\ \ddot{x} - 7\dot{x} + 12x = 0 & (3) \\ \ddot{x} - 9\dot{x} + 20x = 0 & (4) \\ \ddot{x} - 11\dot{x} + 30x = 0 & (5) \\ \ddot{x} - 7\dot{x} + 6x = 0 & (6) \end{cases}$$

where  $\ddot{x} = \frac{d^2x}{dt^2}$  and  $\dot{x} = \frac{dx}{dt}$ . Then the solution basis of equations (1) – (6) are respectively {e<sup>t</sup>, e<sup>2t</sup>}, {e<sup>2t</sup>, e<sup>3t</sup>}, {e<sup>3t</sup>, e<sup>4t</sup>}, {e<sup>4t</sup>, e<sup>5t</sup>}, {e<sup>5t</sup>, e<sup>6t</sup>}, {e<sup>6t</sup>, e<sup>t</sup>} with its G<sup>L</sup>[LDE<sub>m</sub><sup>n</sup>] shown in Fig.5.

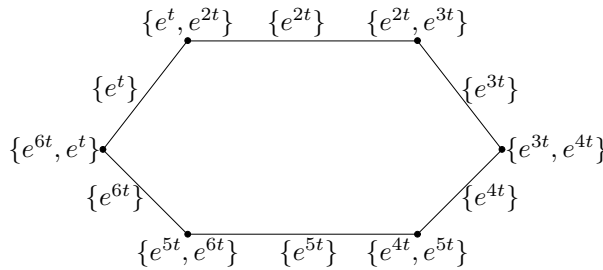

Fig.5

Such a labeling can be simplified to labeling by integers for combinatorially classifying systems G<sup>L</sup>[LDES<sub>m</sub><sup>1</sup>] and G<sup>L</sup>[LDE<sub>m</sub><sup>n</sup>], i.e., integral graphs following.

**Definition 3.6** Let G be a simple graph. A vertex-edge labeled graph θ : G → Z<sup>+</sup> is called integral if θ(uv) ≤ min{θ(u), θ(v)} for ∀uv ∈ E(G), denoted by G<sup>Iθ</sup>.

For two integral labeled graphs G<sub>1</sub><sup>Iθ</sup> and G<sub>2</sub><sup>Iτ</sup>, they are called identical if G<sub>1</sub> ≅ G<sub>2</sub> and θ(x) = τ(φ(x)) for any graph isomorphism φ and ∀x ∈ V(G<sub>1</sub>) ∪ E(G<sub>1</sub>), denoted by G<sub>1</sub><sup>Iθ</sup> = G<sub>2</sub><sup>Iτ</sup>. Otherwise, non-identical.

For example, the graphs shown in Fig.6 are all integral on  $K_4 - e$ , but  $G_1^{I_\theta} = G_2^{I_\tau}$ ,  $G_1^{I_\theta} \neq G_3^{I_\sigma}$ .

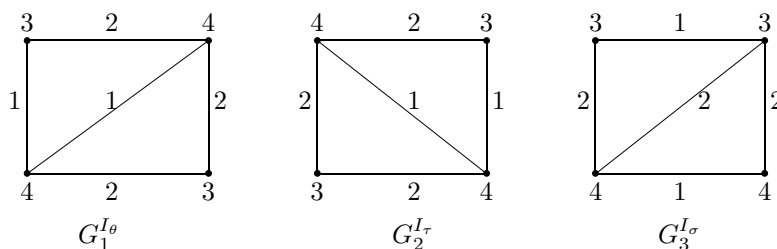

Fig.6

Applying integral graphs, the systems  $(LDES_m^1)$  and  $(LDE_m^n)$  are combinatorially classified in [17] following.

**Theorem 3.7**([17]) *Let  $(LDES_m^1)$ ,  $(LDES_m^1)'$  (or  $(LDE_m^n)$ ,  $(LDE_m^n)'$ ) be two linear homogeneous differential equation systems with integral labeled graphs  $H, H'$ . Then  $(LDES_m^1) \cong (LDES_m^1)'$  (or  $(LDE_m^n) \cong (LDE_m^n)'$ ) if and only if  $H = H'$ .*

### 3.2 Differential Manifolds on $G^L$ -Systems of Equations

By definition, the union  $\widetilde{M} = \bigcup_{k=1}^m S^{[k]}$  is an  $n$ -manifold. The following result is immediately known.

**Theorem 3.8**([17]-[18],[21]) *For any simply graph  $G$ , there are differentiable solution-manifolds of  $(PDES_m)$ ,  $(LDES_m^1)$ ,  $(LDE_m^n)$  such that  $\widehat{G}[PDES] \simeq G$ ,  $\widehat{G}[LDES_m^1] \simeq G$  and  $\widehat{G}[LDE_m^n] \simeq G$ .*

Notice that a basis on vector field  $T(M)$  of a differentiable  $n$ -manifold  $M$  is

$$\left\{ \frac{\partial}{\partial x_i}, 1 \leq i \leq n \right\}$$

and a vector field  $X$  can be viewed as a first order partial differential operator

$$X = \sum_{i=1}^n a_i \frac{\partial}{\partial x_i},$$

where  $a_i$  is  $C^\infty$ -differentiable for all integers  $1 \leq i \leq n$ . Combining Theorems 3.5 and 3.8 enables one to get a result on vector fields following.

**Theorem 3.9**([21]) *For an integer  $m \geq 1$ , let  $U_i, 1 \leq i \leq m$  be open sets in  $\mathbb{R}^n$  underlying a graph defined by  $V(G) = \{U_i | 1 \leq i \leq m\}$ ,  $E(G) = \{(U_i, U_j) | U_i \cap U_j \neq \emptyset, 1 \leq i, j \leq m\}$ . If  $X_i$  is a vector field on  $U_i$  for integers  $1 \leq i \leq m$ , then there always exists a differentiable manifold*

$M \subset \mathbb{R}^n$  with atlas  $\mathcal{A} = \{(U_i, \phi_i) | 1 \leq i \leq m\}$  underlying graph  $G$  and a function  $u_G \in \Omega^0(M)$  such that  $X_i(u_G) = 0, 1 \leq i \leq m$ .

§4. Applications

In philosophy, every thing is a  $G^L$ -system with contradictions embedded in our world, which implies that the geometry on non-solvable system of equations is in fact a truthful portraying of things with applications to various fields, particularly, the understanding on gravitational fields and the controlling of industrial systems.

4.1 Gravitational Fields

An immediate application of geometry on  $G^L$ -systems of non-solvable equations is that it can provides one with a visualization on things in space of dimension  $\geq 4$  by decomposing the space into subspaces underlying a graph  $G^L$ . For example, a decomposition of a Euclidean space into  $\mathbb{R}^3$  is shown in Fig.7, where  $G^L \simeq K_4$ , a complete graph of order 4 and  $\mathcal{P}_1, \mathcal{P}_2, \mathcal{P}_3, \mathcal{P}_4$  are the observations on its subspaces  $\mathbb{R}^3$ . This space model enable one to hold well local behaviors of the spacetime in  $\mathbb{R}^3$  as usual and then determine its global behavior naturally, different from the *string theory* by artificial assuming the dimension of the universe is 11.

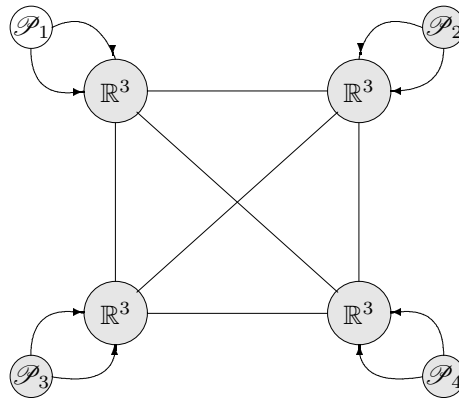

Fig.7

Notice that  $\mathbb{R}^3$  is in a general position and maybe  $\mathbb{R}^3 \cap \mathbb{R}^3 \neq \mathbb{R}^3$  here. Generally, if  $G^L \simeq K_m$ , we know its dimension following.

**Theorem 4.1**([9],[13]) Let  $\mathcal{E}_{K_m}(3)$  be a  $K_m$ -space of  $\underbrace{\mathbb{R}_1^3, \dots, \mathbb{R}^3}_m$ . Then its minimum dimension

$$\dim_{min} \mathcal{E}_{K_m}(3) = \begin{cases} 3, & \text{if } m = 1, \\ 4, & \text{if } 2 \leq m \leq 4, \\ 5, & \text{if } 5 \leq m \leq 10, \\ 2 + \lceil \sqrt{m} \rceil, & \text{if } m \geq 11 \end{cases}$$

and maximum dimension

$$\dim_{max} \mathcal{E}_{K_m}(3) = 2m - 1$$

with  $\mathbb{R}_i^3 \cap \mathbb{R}_j^3 = \bigcap_{i=1}^m \mathbb{R}_i^3$  for any integers  $1 \leq i, j \leq m$ .

For the gravitational field, by applying the *geometrization of gravitation* in  $\mathbb{R}^3$ , Einstein got his gravitational equations with time ([1])

$$R^{\mu\nu} - \frac{1}{2}Rg^{\mu\nu} + \lambda g^{\mu\nu} = -8\pi GT^{\mu\nu}$$

where  $R^{\mu\nu} = R_{\alpha}^{\mu\alpha\nu} = g_{\alpha\beta}R^{\alpha\mu\beta\nu}$ ,  $R = g_{\mu\nu}R^{\mu\nu}$  are the respective Ricci tensor, Ricci scalar curvature,  $G = 6.673 \times 10^{-8} cm^3/gs^2$ ,  $\kappa = 8\pi G/c^4 = 2.08 \times 10^{-48} cm^{-1} \cdot g^{-1} \cdot s^2$ , which has a spherically symmetric solution on Riemannian metric, called *Schwarzschild spacetime*

$$ds^2 = f(t) \left(1 - \frac{r_s}{r}\right) dt^2 - \frac{1}{1 - \frac{r_s}{r}} dr^2 - r^2(d\theta^2 + \sin^2 \theta d\phi^2)$$

for  $\lambda = 0$  in vacuum, where  $r_g$  is the *Schwarzschild radius*. Thus, if the dimension of the universe  $\geq 4$ , all these observations are nothing else but a projection of the true faces on our six organs, a pseudo-truth. However, we can characterize its global behavior by  $K_m^L$ -space solutions of  $\mathbb{R}^3$  (See [8]-[10] for details). For example, if  $m = 4$ , there are 4 Einstein's gravitational equations for  $\forall v \in V(K_4^L)$ . We can solving it locally by spherically symmetric solutions in  $\mathbb{R}^3$  and construct a  $K_4^L$ -solution  $S_{f_1}, S_{f_2}, S_{f_3}$  and  $S_{f_4}$ , such as those shown in Fig.8,

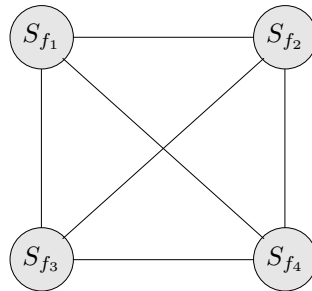

Fig.8

where, each  $S_{f_i}$  is a geometrical space determined by Schwarzschild spacetime

$$ds^2 = f(t) \left(1 - \frac{r_s}{r}\right) dt^2 - \frac{1}{1 - \frac{r_s}{r}} dr^2 - r^2(d\theta^2 + \sin^2 \theta d\phi^2)$$

for integers  $1 \leq i \leq m$ . Certainly, its global behavior depends on the intersections  $S_{f_i} \cap S_{f_j}, 1 \leq i \neq j \leq 4$ .

### 4.2 Ecologically Industrial Systems

Determining a system, particularly, an industrial system on initial values being stable or not is



an important problem because it reveals that this system is controllable or not by human beings. Usually, such a system is characterized by a system of differential equations. For example, let

$$\begin{cases} A \rightarrow X \\ 2X + Y \rightarrow 3X \\ B + X \rightarrow Y + D \\ X \rightarrow E \end{cases}$$

be the *Brusselator model* on chemical reaction, where  $A, B, X, Y$  are respectively the concentrations of 4 materials in this reaction. By the chemical dynamics if the initial concentrations for  $A, B$  are chosen sufficiently larger, then  $X$  and  $Y$  can be characterized by differential equations

$$\frac{\partial X}{\partial t} = k_1 \Delta X + A + X^2 Y - (B + 1)X, \quad \frac{\partial Y}{\partial t} = k_2 \Delta Y + BX - X^2 Y.$$

As we known, the stability of a system is determined by its solutions in classical sciences. But if the system of equations is non-solvable, *what is its stability?* It should be noted that non-solvable systems of equations extensively exist in our daily life. For example, an industrial system with raw materials  $M_1, M_2, \dots, M_n$ , products (including by-products)  $P_1, P_2, \dots, P_m$  but  $W_1, W_2, \dots, W_s$  wastes after a produce process, such as those shown in Fig.9 following,

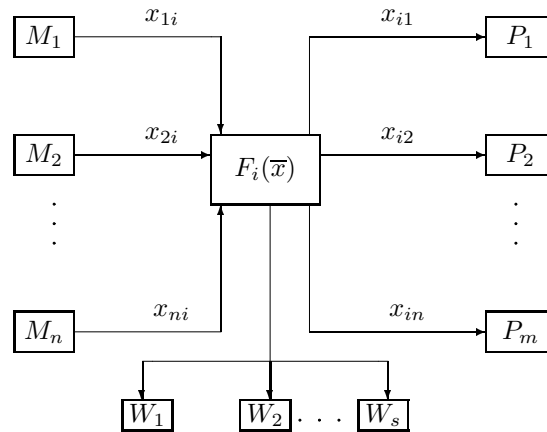

Fig.9

which is an opened system and can be transferred to a closed one by letting the environment as an additional cell, called an *ecologically industrial system*. However, such an ecologically industrial system is usually a non-solvable system of equations by the input-output model in economy, see [20] for details.

Certainly, the global stability depends on the local stabilities. Applying the  $G$ -solution of a  $G^L$ -system  $(DES_m^C)$  of differential equations, the global stability is defined following.

**Definition 4.2** Let  $(PDES_m^C)$  be a Cauchy problem on a system of partial differential equations of first order in  $\mathbb{R}^n$ ,  $H \leq G[PDES_m^C]$  a spanning subgraph, and  $u^{[v]}$  the solution of the  $v$ th

equation with initial value  $u_0^{[v]}$ ,  $v \in V(H)$ . It is sum-stable on the subgraph  $H$  if for any number  $\varepsilon > 0$  there exists,  $\delta_v > 0$ ,  $v \in V(H)$  such that each  $G(t)$ -solution with

$$\left| u_0'^{[v]} - u_0^{[v]} \right| < \delta_v, \quad \forall v \in V(H)$$

exists for all  $t \geq 0$  and with the inequality

$$\left| \sum_{v \in V(H)} u'^{[v]} - \sum_{v \in V(H)} u^{[v]} \right| < \varepsilon$$

holds, denoted by  $G[t] \overset{H}{\sim} G[0]$  and  $G[t] \overset{\Sigma}{\sim} G[0]$  if  $H = G[PDES_m^C]$ . Furthermore, if there exists a number  $\beta_v > 0$ ,  $v \in V(H)$  such that every  $G'[t]$ -solution with

$$\left| u_0'^{[v]} - u_0^{[v]} \right| < \beta_v, \quad \forall v \in V(H)$$

satisfies

$$\lim_{t \rightarrow \infty} \left| \sum_{v \in V(H)} u'^{[v]} - \sum_{v \in V(H)} u^{[v]} \right| = 0,$$

then the  $G[t]$ -solution is called asymptotically stable, denoted by  $G[t] \overset{H}{\rightarrow} G[0]$  and  $G[t] \overset{\Sigma}{\rightarrow} G[0]$  if  $H = G[PDES_m^C]$ .

Let  $(PDES_m^C)$  be a system

$$\left. \begin{aligned} \frac{\partial u}{\partial t} &= H_i(t, x_1, \dots, x_{n-1}, p_1, \dots, p_{n-1}) \\ u|_{t=t_0} &= u_0^{[i]}(x_1, x_2, \dots, x_{n-1}) \end{aligned} \right\} 1 \leq i \leq m \quad (APDES_m^C)$$

A point  $X_0^{[i]} = (t_0, x_{10}^{[i]}, \dots, x_{(n-1)0}^{[i]})$  with  $H_i(t_0, x_{10}^{[i]}, \dots, x_{(n-1)0}^{[i]}) = 0$  for an integer  $1 \leq i \leq m$  is called an *equilibrium point* of the  $i$ th equation in  $(APDES_m)$ . A result on the sum-stability of  $(APDES_m)$  is known in [18] and [21] following.

**Theorem 4.3**([18],[21]) *Let  $X_0^{[i]}$  be an equilibrium point of the  $i$ th equation in  $(APDES_m)$  for each integer  $1 \leq i \leq m$ . If*

$$\sum_{i=1}^m H_i(X) > 0 \quad \text{and} \quad \sum_{i=1}^m \frac{\partial H_i}{\partial t} \leq 0$$

for  $X \neq \sum_{i=1}^m X_0^{[i]}$ , then the system  $(APDES_m)$  is sum-stability, i.e.,  $G[t] \overset{\Sigma}{\sim} G[0]$ . Furthermore, if

$$\sum_{i=1}^m \frac{\partial H_i}{\partial t} < 0$$

for  $X \neq \sum_{i=1}^m X_0^{[i]}$ , then  $G[t] \overset{\Sigma}{\rightarrow} G[0]$ .

Particularly, if the non-solvable system is a linear homogenous differential equation systems ( $LDES_m^1$ ), we further get a simple criterion on its zero  $G^L$ -solution, i.e., all vertices with 0 labels in [17] following.

**Theorem 4.4**([17]) *The zero  $G$ -solution of linear homogenous differential equation systems ( $LDES_m^1$ ) is asymptotically sum-stable on a spanning subgraph  $H \leq G[LDES_m^1]$  if and only if  $\text{Re}\alpha_v < 0$  for each  $\bar{\beta}_v(t)e^{\alpha_v t} \in \mathcal{B}_v$  in ( $LDES^1$ ) hold for  $\forall v \in V(H)$ .*

## §5. Conclusions

For human beings, the world is hybrid and filled with contradictions. That is why it is said that *all contradictions are artificial or man-made, not the nature of world* in this paper. In philosophy, a mathematics is nothing else but a set of *symbolic names with relations*. However, as *Lao Zi* said *name named is not the eternal name, the unnamable is the eternally real and naming is the origin of things* for human beings in his *TAO TEH KING*, a well-known Chinese book. It is difficult to establish such a mathematics join tightly with the world. Even so, for knowing the world, one should develops mathematics well by turning all these mathematical systems with artificial contradictions to a compatible system, i.e., out of the classical run in mathematics but return to their origins. For such an aim, geometry is more applicable, which is an encouraging thing for mathematicians in 21<sup>th</sup> century.

## References

- [1] M.Carmeli, *Classical Fields–General Relativity and Gauge Theory*, World Scientific, 2001.
- [2] Fritz John. *Partial Differential Equations*(4th Edition). New York, USA: Springer-Verlag, 1982.
- [3] H.Iseri, *Smarandache Manifolds*, American Research Press, Rehoboth, NM,2002.
- [4] John M.Lee, *Introduction to Topological Manifolds*, Springer-Verlag New York, Inc., 2000.
- [5] F.Klein, A comparative review of recent researches in geometry, *Bull. New York Math. Soc.*, 2(1892-1893), 215-249.
- [6] Linfan Mao, Combinatorial speculation and combinatorial conjecture for mathematics, *International J.Math. Combin.* Vol.1(2007), No.1, 1-19.
- [7] Linfan Mao, Geometrical theory on combinatorial manifolds, *JP J.Geometry and Topology*, Vol.7, No.1(2007),65-114.
- [8] Linfan Mao, Combinatorial fields-an introduction, *International J. Math.Combin.*, Vol.1(2009), Vol.3, 1-22.
- [9] Linfan Mao, A combinatorial decomposition of Euclidean spaces  $\mathbb{R}^n$  with contribution to visibility, *International J. Math.Combin.*, Vol.1(2010), Vol.1, 47-64.
- [10] Linfan Mao, Relativity in combinatorial gravitational fields, *Progress in Physics*, Vol.3(2010), 39-50.
- [11] Linfan Mao, *Automorphism Groups of Maps, Surfaces and Smarandache Geometries*, First edition published by American Research Press in 2005, Second edition is as a Graduate

- Textbook in Mathematics, Published by The Education Publisher Inc., USA, 2011.
- [12] Linfan Mao, *Smarandache Multi-Space Theory*, First edition published by Hexis, Phoenix in 2006, Second edition is as a Graduate Textbook in Mathematics, Published by The Education Publisher Inc., USA, 2011.
  - [13] Linfan Mao, *Combinatorial Geometry with Applications to Field Theory*, First edition published by InfoQuest in 2005, Second edition is as a Graduate Textbook in Mathematics, Published by The Education Publisher Inc., USA, 2011.
  - [14] Linfan Mao, Graph structure of manifolds with listing, *International J.Contemp. Math. Sciences*, Vol.5, 2011, No.2,71-85.
  - [15] Linfan Mao, A generalization of Seifert-Van Kampen theorem for fundamental groups, *Far East Journal of Math.Sciences*, Vol.61 No.2 (2012), 141-160.
  - [16] Linfan Mao, Non-solvable spaces of linear equation systems, *International J. Math. Combin.*, Vol.2 (2012), 9-23.
  - [17] Linfan Mao, Global stability of non-solvable ordinary differential equations with applications, *International J.Math. Combin.*, Vol.1 (2013), 1-37.
  - [18] Linfan Mao, Non-solvable equation systems with graphs embedded in  $\mathbf{R}^n$ , *International J.Math. Combin.*, Vol.2 (2013), 8-23, Also in *Proceedings of the First International Conference on Smarandache Multispace and Multistructure*, The Education Publisher Inc. July, 2013
  - [19] Linfan Mao, Geometry on  $G^L$ -systems of homogenous polynomials, *International J.Contemp. Math. Sciences*, Vol.9 (2014), No.6, 287-308.
  - [20] Linfan Mao, A topological model for ecologically industrial systems, *International J.Math. Combin.*, Vol.1 (2014), 109-117.
  - [21] Linfan Mao, Cauchy problem on non-solvable system of first order partial differential equations with applications, *Methods and Applications of Analysis* (Accepted).
  - [22] Linfan Mao, Mathematics on non-mathematics - A combinatorial contribution, *International J.Math. Combin.*, Vol.3(2014), 1-34.
  - [23] F.Smarandache, *Paradoxist Geometry*, State Archives from Valcea, Rm. Valcea, Romania, 1969, and in *Paradoxist Mathematics*, Collected Papers (Vol. II), Kishinev University Press, Kishinev, 5-28, 1997.
  - [24] F.Smarandache, Multi-space and multi-structure, in *Neutrosophy. Neutrosophic Logic, Set, Probability and Statistics*, American Research Press, 1998.
  - [25] F.Smarandache, *A Unifying Field in Logics. Neutrosopy: Neturosophic Probability, Set, and Logic*, American research Press, Rehoboth, 1999.
  - [26] Wolfgang Walter, *Ordinary Differential Equations*, Springer-Verlag New York, Inc., 1998.

## Chapter 3 Combinatorial Notion on Reality



*Profound thoughts like nails, once the nail in my mind, what also can't pull it out.*

By Denis Diderot, a French philosopher, art critic and writer.

## Combinatorial Speculation And Combinatorial Conjecture for Mathematics

**Abstract Extended:** This survey was widely spread after reported at a combinatorial conference of China in 2006. As a powerful tool for dealing with relations among objectives, combinatorics mushroomed in the past century, particularly in catering to the need of computer science and children games. However, an even more important work for mathematician is to apply it to other mathematics and other sciences besides just to find combinatorial behavior for objectives. *How can it contributes more to the entirely mathematical science, not just in various games, but in metric mathematics? What is a right mathematical theory for the original face of our world?* I presented a well-known proverb, i.e., the six blind men and an elephant in the 3th Northwest Conference on Number Theory and Smarandache's Notion of China and answered the second question to be Smarandache multi-spaces in logic. Prior to that explaining, I have brought a heartening conjecture for advancing mathematics in 2005, i.e., *mathematical science can be reconstructed from or made by combinatorialization* after a long time speculation, also a bringing about Smarandache multispace for mathematics. This conjecture is not just like an open problem, but more like a deeply thought for advancing the modern mathematics. The main trend of modern sciences is overlap and hybrid. Whence the mathematics of 21st century should be consistency with the science development in the 21st century, i.e., the *mathematical combinatorics* resulting in the combinatorial conjecture for mathematics. For introducing more readers known this heartening mathematical notion for sciences, there would be no simple stopping point if I began to incorporate the more recent development, for example, the *combinatorially differential geometry*, so it being published here in its original form to survey these thinking and ideas for mathematics and cosmological physics, such as those of multispaces, map geometries and combinatorial structures of cosmoses. Some open problems are also included for the advance of 21st mathematics by a combinatorial speculation. More recent progresses can be found in papers and books nearly published, for example, in [20]-[23] for details.

**Key words:** combinatorial speculation, combinatorial conjecture for mathematics, Smarandache multispace, M-theory, combinatorial cosmos.

**AMS(2000):** 03C05,05C15,51D20,51H20,51P05,83C05,83E50.

### §1. The role of classical combinatorics in mathematics

Modern science has so advanced that to find a universal genus in the society of sciences is nearly impossible. Thereby a scientist can only give his or her contribution in one or several fields.

---

<sup>1</sup>Reported at the 2nd Conference on Combinatorics and Graph Theory of China, August 16-19, 2007, Tianjing, P.R.China

<sup>2</sup>*International J.Math.Combin*, Vol.1 (2007), 1-19.

The same thing also happens for researchers in combinatorics. Generally, combinatorics deals with twofold:

**Question 1.1.** *to determine or find structures or properties of configurations, such as those structure results appeared in graph theory, combinatorial maps and design theory, ..., etc..*

**Question 1.2.** *to enumerate configurations, such as those appeared in the enumeration of graphs, labeled graphs, rooted maps, unrooted maps and combinatorial designs, ..., etc..*

Consider the contribution of a question to science. We can separate mathematical questions into three ranks:

**Rank 1** *they contribute to all sciences.*

**Rank 2** *they contribute to all or several branches of mathematics.*

**Rank 3** *they contribute only to one branch of mathematics, for instance, just to the graph theory or combinatorial theory.*

Classical combinatorics is just a *rank 3 mathematics* by this view. This conclusion is despair for researchers in combinatorics, also for me 5 years ago. *Whether can combinatorics be applied to other mathematics or other sciences? Whether can it contributes to human's lives, not just in games?*

Although become a universal genus in science is nearly impossible, *our world is a combinatorial world*. A combinatorician should stand on all mathematics and all sciences, not just on classical combinatorics and with a real combinatorial notion, i.e., *combining different fields into a unifying field* ([29]-[32]), such as combine different or even anti-branches in mathematics or science into a unifying science for its freedom of research ([28]). This notion requires us answering three questions for solving a combinatorial problem before. *What is this problem working for? What is its objective? What is its contribution to science or human's society?* After these works be well done, modern combinatorics can applied to all sciences and all sciences are combinatorialization.

## §2. The metrical combinatorics and mathematics combinatorialization

There is a prerequisite for the application of combinatorics to other mathematics and other sciences, i.e, to introduce various metrics into combinatorics, ignored by the classical combinatorics since they are the fundamental of scientific realization for our world. This speculation was firstly appeared in the beginning of Chapter 5 of my book [16]:

*... our world is full of measures. For applying combinatorics to other branch of mathematics, a good idea is pullback measures on combinatorial objects again, ignored by the classical combinatorics and reconstructed or make combinatorial generalization for the classical mathematics, such as those of algebra, differential geometry, Riemann geometry, Smarandache geometries, ... and the mechanics, theoretical physics, ...*

The combinatorial conjecture for mathematics, abbreviated to *CCM* is stated in the following.

**Conjecture 2.1**(CCM Conjecture) *Mathematical science can be reconstructed from or made by combinatorialization.*

**Remark 2.1** We need some further clarifications for this conjecture.

(1) This conjecture assumes that one can select finite combinatorial rulers and axioms to reconstruct or make generalization for classical mathematics.

(2) Classical mathematics is a particular case in the combinatorialization of mathematics, i.e., the later is a combinatorial generalization of the former.

(3) We can make one combinatorialization of different branches in mathematics and find new theorems after then.

Therefore, a branch in mathematics can not be ended if it has not been combinatorialization and all mathematics can not be ended if its combinatorialization has not completed. There is an assumption in one's realization of our world, i.e., *science can be made by mathematicalization*, which enables us get a similar combinatorial conjecture for the science.

**Conjecture 2.2**(CCS Conjecture) *Science can be reconstructed from or made by combinatorialization.*

A typical example for the combinatorialization of classical mathematics is the *combinatorial map theory*, i.e., a combinatorial theory for surfaces([14]-[15]). Combinatorially, a surface is topological equivalent to a polygon with even number of edges by identifying each pairs of edges along a given direction on it. If label each pair of edges by a letter  $e, e \in \mathcal{E}$ , a surface  $S$  is also identifying to a cyclic permutation such that each edge  $e, e \in \mathcal{E}$  just appears two times in  $S$ , one is  $e$  and another is  $e^{-1}$ . Let  $a, b, c, \dots$  denote the letters in  $\mathcal{E}$  and  $A, B, C, \dots$  the sections of successive letters in a linear order on a surface  $S$  (or a string of letters on  $S$ ). Then, a surface can be represented as follows:

$$S = (\dots, A, a, B, a^{-1}, C, \dots),$$

where,  $a \in \mathcal{E}, A, B, C$  denote a string of letters. Define three elementary transformations as follows:

$$\begin{aligned} (O_1) \quad & (A, a, a^{-1}, B) \Leftrightarrow (A, B); \\ (O_2) \quad & (i) \quad (A, a, b, B, b^{-1}, a^{-1}) \Leftrightarrow (A, c, B, c^{-1}); \\ & (ii) \quad (A, a, b, B, a, b) \Leftrightarrow (A, c, B, c); \\ (O_3) \quad & (i) \quad (A, a, B, C, a^{-1}, D) \Leftrightarrow (B, a, A, D, a^{-1}, C); \\ & (ii) \quad (A, a, B, C, a, D) \Leftrightarrow (B, a, A, C^{-1}, a, D^{-1}). \end{aligned}$$

If a surface  $S$  can be obtained from  $S_0$  by these elementary transformations  $O_1$ - $O_3$ , we say that  $S$  is elementary equivalent with  $S_0$ , denoted by  $S \sim_{El} S_0$ . Then we can get the classification theorem of compact surface as follows([29]):

*Any compact surface is homeomorphic to one of the following standard surfaces:*

$$(P_0) \text{ the sphere: } aa^{-1};$$



$(P_n)$  the connected sum of  $n, n \geq 1$  tori:

$$a_1 b_1 a_1^{-1} b_1^{-1} a_2 b_2 a_2^{-1} b_2^{-1} \cdots a_n b_n a_n^{-1} b_n^{-1};$$

$(Q_n)$  the connected sum of  $n, n \geq 1$  projective planes:

$$a_1 a_1 a_2 a_2 \cdots a_n a_n.$$

A map  $M$  is a connected topological graph cellularly embedded in a surface  $S$ . In 1973, Tutte suggested an algebraic representation for an embedding graph on a locally orientable surface ([16]):

A combinatorial map  $M = (\mathcal{X}_{\alpha, \beta}, \mathcal{P})$  is defined to be a basic permutation  $\mathcal{P}$ , i.e., for any  $x \in \mathcal{X}_{\alpha, \beta}$ , no integer  $k$  exists such that  $\mathcal{P}^k x = \alpha x$ , acting on  $\mathcal{X}_{\alpha, \beta}$ , the disjoint union of quadricells  $Kx$  of  $x \in X$  (the base set), where  $K = \{1, \alpha, \beta, \alpha\beta\}$  is the Klein group satisfying the following two conditions:

- (i)  $\alpha\mathcal{P} = \mathcal{P}^{-1}\alpha$ ;
- (ii) the group  $\Psi_J = \langle \alpha, \beta, \mathcal{P} \rangle$  is transitive on  $\mathcal{X}_{\alpha, \beta}$ .

For a given map  $M = (\mathcal{X}_{\alpha, \beta}, \mathcal{P})$ , it can be shown that  $M^* = (\mathcal{X}_{\beta, \alpha}, \mathcal{P}\alpha\beta)$  is also a map, call it the dual of the map  $M$ . The vertices of  $M$  are defined as the pairs of conjugate orbits of  $\mathcal{P}$  action on  $\mathcal{X}_{\alpha, \beta}$  by the condition (i) and edges the orbits of  $K$  on  $\mathcal{X}_{\alpha, \beta}$ , for example, for  $\forall x \in \mathcal{X}_{\alpha, \beta}$ ,  $\{x, \alpha x, \beta x, \alpha\beta x\}$  is an edge of the map  $M$ . Define the faces of  $M$  to be the vertices in the dual map  $M^*$ . Then the Euler characteristic  $\chi(M)$  of the map  $M$  is

$$\chi(M) = \nu(M) - \varepsilon(M) + \phi(M)$$

where,  $\nu(M), \varepsilon(M), \phi(M)$  are the number of vertices, edges and faces of the map  $M$ , respectively. For each vertex of a map  $M$ , its valency is defined to be the length of the orbits of  $\mathcal{P}$  action on a quadricell incident with  $u$ .

For example, the graph  $K_4$  on the torus with one face length 4 and another 8 is shown in Fig.1

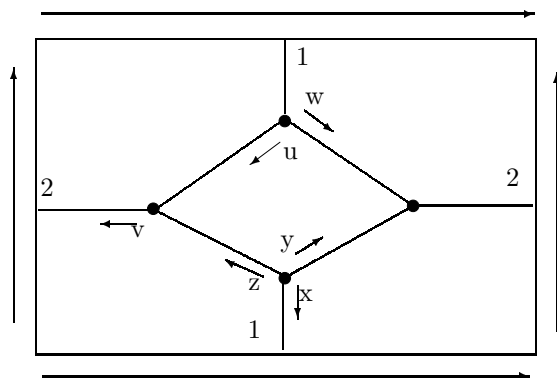

Fig.1

can be algebraically represented by  $(\mathcal{X}_{\alpha,\beta}, \mathcal{P})$  with  $\mathcal{X}_{\alpha,\beta} = \{x, y, z, u, v, w, \alpha x, \alpha y, \alpha z, \alpha u, \alpha v, \alpha w, \beta x, \beta y, \beta z, \beta u, \beta v, \beta w, \alpha\beta x, \alpha\beta y, \alpha\beta z, \alpha\beta u, \alpha\beta v, \alpha\beta w\}$  and

$$\begin{aligned} \mathcal{P} = & (x, y, z)(\alpha\beta x, u, w)(\alpha\beta z, \alpha\beta u, v)(\alpha\beta y, \alpha\beta v, \alpha\beta w) \\ & \times (\alpha x, \alpha z, \alpha y)(\beta x, \alpha w, \alpha u)(\beta z, \alpha v, \beta u)(\beta y, \beta w, \beta v) \end{aligned}$$

with 4 vertices, 6 edges and 2 faces on an orientable surface of genus 1.

By the view of combinatorial maps, these standard surfaces  $P_0, P_n, Q_n$  for  $n \geq 1$  is nothing but the bouquet  $B_n$  on a locally orientable surface with just one face. Therefore, combinatorial maps are the combinatorialization of surfaces.

Many open problems are motivated by the *CCM Conjecture*. For example, a *Gauss mapping* among surfaces is defined as follows:

Let  $\mathcal{S} \subset \mathbb{R}^3$  be a surface with an orientation  $\mathbf{N}$ . The mapping  $\mathbf{N} : \mathcal{S} \rightarrow \mathbb{R}^3$  takes its value in the unit sphere

$$S^2 = \{(x, y, z) \in \mathbb{R}^3 \mid x^2 + y^2 + z^2 = 1\}$$

along the orientation  $\mathbf{N}$ . The map  $\mathbf{N} : \mathcal{S} \rightarrow S^2$ , thus defined, is called the *Gauss mapping*.

We know that for a point  $P \in \mathcal{S}$  such that the Gaussian curvature  $K(P) \neq 0$  and  $V$  a connected neighborhood of  $P$  with  $K$  does not change sign,

$$K(P) = \lim_{A \rightarrow 0} \frac{N(A)}{A},$$

where  $A$  is the area of a region  $B \subset V$  and  $N(A)$  is the area of the image of  $B$  by the Gauss mapping  $N : \mathcal{S} \rightarrow S^2$  ([2],[4]). Now the questions are

- (i) what is its combinatorial meaning of the Gauss mapping? How to realizes it by combinatorial maps?
- (ii) how can we define various curvatures for maps and rebuilt these results in the classical differential geometry?

Let  $\mathcal{S}$  be a compact orientable surface. Then the *Gauss-Bonnet theorem* asserts that

$$\int \int_{\mathcal{S}} K d\sigma = 2\pi\chi(\mathcal{S}),$$

where  $K$  is the Gaussian curvature of  $\mathcal{S}$ .

By the *CCM Conjecture*, the following questions should be considered.

- (i) How can we define various metrics for combinatorial maps, such as those of length, distance, angle, area, curvature, ... ?
- (ii) Can we rebuilt the Gauss-Bonnet theorem by maps for dimensional 2 or higher dimensional compact manifolds without boundary?

One can see references [15] and [16] for more open problems for the classical mathematics motivated by this *CCM Conjecture*, also raise new open problems for his or her research works.

### §3. The contribution of combinatorial speculation to mathematics

#### 3.1. The combinatorialization of algebra

By the view of combinatorics, algebra can be seen as a combinatorial mathematics itself. The combinatorial speculation can generalize it by the means of combinatorialization. For this objective, a Smarandache multi-algebraic system is combinatorially defined in the following definition.

**Definition 3.1**([17],[18]) *For any integers  $n, n \geq 1$  and  $i, 1 \leq i \leq n$ , let  $A_i$  be a set with an operation set  $O(A_i)$  such that  $(A_i, O(A_i))$  is a complete algebraic system. Then the union*

$$\bigcup_{i=1}^n (A_i, O(A_i))$$

*is called an  $n$  multi-algebra system.*

An example of multi-algebra systems is constructed by a finite additive group. Now let  $n$  be an integer,  $Z_1 = (\{0, 1, 2, \dots, n-1\}, +)$  an additive group (*mod* $n$ ) and  $P = (0, 1, 2, \dots, n-1)$  a permutation. For any integer  $i, 0 \leq i \leq n-1$ , define

$$Z_{i+1} = P^i(Z_1)$$

satisfying that if  $k + l = m$  in  $Z_1$ , then  $P^i(k) +_i P^i(l) = P^i(m)$  in  $Z_{i+1}$ , where  $+_i$  denotes the binary operation  $+_i : (P^i(k), P^i(l)) \rightarrow P^i(m)$ . Then we know that

$$\bigcup_{i=1}^n Z_i$$

is an  $n$  multi-algebra system .

The conception of multi-algebra systems can be extensively used for generalizing conceptions and results for these existent algebraic structures, such as those of groups, rings, bodies, fields and vector spaces,  $\dots$ , etc.. Some of them are explained in the following.

**Definition 3.2** *Let  $\tilde{G} = \bigcup_{i=1}^n G_i$  be a closed multi-algebra system with a binary operation set  $O(\tilde{G}) = \{\times_i, 1 \leq i \leq n\}$ . If for any integer  $i, 1 \leq i \leq n$ ,  $(G_i; \times_i)$  is a group and for  $\forall x, y, z \in \tilde{G}$  and any two binary operations " $\times$  and  $\circ$ ,  $\times \neq \circ$ , there is one operation, for example the operation  $\times$  satisfying the distribution law to the operation " $\circ$  provided their operation results exist , i.e.,*

$$x \times (y \circ z) = (x \times y) \circ (x \times z),$$

$$(y \circ z) \times x = (y \times x) \circ (z \times x),$$

*then  $\tilde{G}$  is called a multigroup.*

For a multigroup  $(\tilde{G}, O(\tilde{G}))$ ,  $\tilde{G}_1 \subset \tilde{G}$  and  $O(\tilde{G}_1) \subset O(\tilde{G})$ , call  $(\tilde{G}_1, O(\tilde{G}_1))$  a *submultigroup*

of  $(\tilde{G}, O(\tilde{G}))$  if  $\tilde{G}_1$  is also a multigroup under the operations in  $O(\tilde{G}_1)$ , denoted by  $\tilde{G}_1 \preceq \tilde{G}$ . For two sets  $A$  and  $B$ , if  $A \cap B = \emptyset$ , we denote the union  $A \cup B$  by  $A \oplus B$ . Then we get a generalization of the *Lagrange theorem* of finite group.

**Theorem 3.1**([18]) *For any submultigroup  $\tilde{H}$  of a finite multigroup  $\tilde{G}$ , there is a representation set  $T, T \subset \tilde{G}$ , such that*

$$\tilde{G} = \bigoplus_{x \in T} x\tilde{H}.$$

For a submultigroup  $\tilde{H}$  of  $\tilde{G}$ ,  $\times \in O(\tilde{H})$  and  $\forall g \in \tilde{G}(\times)$ , if for  $\forall h \in \tilde{H}$ ,

$$g \times h \times g^{-1} \in \tilde{H},$$

then call  $\tilde{H}$  a *normal submultigroup* of  $\tilde{G}$ . An order of operations in  $O(\tilde{G})$  is said an *oriented operation sequence*, denoted by  $\vec{O}(\tilde{G})$ . We get a generalization of the *Jordan-Hölder theorem* for finite multi-groups.

**Theorem 3.2**([18]) *For a finite multigroup  $\tilde{G} = \bigcup_{i=1}^n G_i$  and an oriented operation sequence  $\vec{O}(\tilde{G})$ , the length of maximal series of normal submultigroups is a constant, only dependent on  $\tilde{G}$  itself.*

In Definition 2.2, choose  $n = 2, G_1 = G_2 = \tilde{G}$ . Then  $\tilde{G}$  is a body. If  $(G_1; \times_1)$  and  $(G_2; \times_2)$  both are commutative groups, then  $\tilde{G}$  is a field. For multi-algebra systems with two or more operations on one set, we introduce the conception of multi-rings and multi-vector spaces in the following.

**Definition 3.3** *Let  $\tilde{R} = \bigcup_{i=1}^m R_i$  be a closed multi-algebra system with double binary operation set  $O(\tilde{R}) = \{(+_i, \times_i) | 1 \leq i \leq m\}$ . If for any integers  $i, j, i \neq j, 1 \leq i, j \leq m$ ,  $(R_i; +_i, \times_i)$  is a ring and for  $\forall x, y, z \in \tilde{R}$ ,*

$$(x +_i y) +_j z = x +_i (y +_j z), \quad (x \times_i y) \times_j z = x \times_i (y \times_j z)$$

and

$$x \times_i (y +_j z) = x \times_i y +_j x \times_i z, \quad (y +_j z) \times_i x = y \times_i x +_j z \times_i x$$

provided all their operation results exist, then  $\tilde{R}$  is called a *multi-ring*. If for any integer  $1 \leq i \leq m$ ,  $(R_i; +_i, \times_i)$  is a field, then  $\tilde{R}$  is called a *multifield*.

**Definition 3.4** *Let  $\tilde{V} = \bigcup_{i=1}^k V_i$  be a closed multi-algebra system with binary operation set  $O(\tilde{V}) = \{(\dot{+}_i, \cdot_i) | 1 \leq i \leq m\}$  and  $\tilde{F} = \bigcup_{i=1}^k F_i$  a multi-field with double binary operation set  $O(\tilde{F}) = \{(+_i, \times_i) | 1 \leq i \leq k\}$ . If for any integers  $i, j, 1 \leq i, j \leq k$  and  $\forall \mathbf{a}, \mathbf{b}, \mathbf{c} \in \tilde{V}, k_1, k_2 \in \tilde{F}$ ,*

- (i)  $(V_i; \dot{+}_i, \cdot_i)$  is a vector space on  $F_i$  with vector additive  $\dot{+}_i$  and scalar multiplication  $\cdot_i$ ;
- (ii)  $(\mathbf{a} \dot{+}_i \mathbf{b}) \dot{+}_j \mathbf{c} = \mathbf{a} \dot{+}_i (\mathbf{b} \dot{+}_j \mathbf{c})$ ;

$$(iii) (k_1 +_i k_2) \cdot_j \mathbf{a} = k_1 +_i (k_2 \cdot_j \mathbf{a});$$

provided all those operation results exist, then  $\widetilde{V}$  is called a multi-vector space on the multi-filed  $\widetilde{F}$  with a binary operation set  $O(\widetilde{V})$ , denoted by  $(\widetilde{V}; \widetilde{F})$ .

Similar to multigroups, we can also obtain results for multirings and multi-vector spaces to generalize classical results in rings or linear spaces. Certainly, results can be also found in the references [17] and [18].

### 3.2. The combinatorialization of geometries

First, we generalize classical metric spaces by the combinatorial speculation.

**Definition 3.5** A multi-metric space is a union  $\widetilde{M} = \bigcup_{i=1}^m M_i$  such that each  $M_i$  is a space with metric  $\rho_i$  for  $\forall i, 1 \leq i \leq m$ .

We generalized two well-known results in metric spaces.

**Theorem 3.3**([19]) Let  $\widetilde{M} = \bigcup_{i=1}^m M_i$  be a completed multi-metric space. For an  $\epsilon$ -disk sequence  $\{B(\epsilon_n, x_n)\}$ , where  $\epsilon_n > 0$  for  $n = 1, 2, 3, \dots$ , the following conditions hold:

$$(i) B(\epsilon_1, x_1) \supset B(\epsilon_2, x_2) \supset B(\epsilon_3, x_3) \supset \dots \supset B(\epsilon_n, x_n) \supset \dots;$$

$$(ii) \lim_{n \rightarrow +\infty} \epsilon_n = 0.$$

Then  $\bigcap_{n=1}^{+\infty} B(\epsilon_n, x_n)$  only has one point.

**Theorem 3.4**([19]) Let  $\widetilde{M} = \bigcup_{i=1}^m M_i$  be a completed multi-metric space and  $T$  a contraction on  $\widetilde{M}$ . Then

$$1 \leq \# \Phi(T) \leq m.$$

Particularly, let  $m = 1$ . We get the *Banach fixed-point theorem* again.

**Corollary 3.1**(Banach) Let  $M$  be a metric space and  $T$  a contraction on  $M$ . Then  $T$  has just one fixed point.

*Smarandache geometries* were proposed by Smarandache in [29] which are generalization of classical geometries, i.e., these *Euclid*, *Lobachevshy-Bolyai-Gauss* and *Riemann geometries* may be united altogether in a same space, by some Smarandache geometries under the combinatorial speculation. These geometries can be either partially Euclidean and partially Non-Euclidean, or Non-Euclidean. In general, Smarandache geometries are defined in the next.

**Definition 3.6** An axiom is said to be *Smarandachely denied* if the axiom behaves in at least two different ways within the same space, i.e., validated and invalidated, or only invalidated but in multiple distinct ways.

A *Smarandache geometry* is a geometry which has at least one *Smarandachely denied axiom*(1969).

For example, let us consider an euclidean plane  $\mathbf{R}^2$  and three non-collinear points  $A, B$  and  $C$ . Define  $s$ -points as all usual euclidean points on  $\mathbf{R}^2$  and  $s$ -lines as any euclidean line that passes through one and only one of points  $A, B$  and  $C$ . Then this geometry is a Smarandache geometry because two axioms are Smarandachely denied comparing with an Euclid geometry:

(i) The axiom (A5) that through a point exterior to a given line there is only one parallel passing through it is now replaced by two statements: *one parallel* and *no parallel*. Let  $L$  be an  $s$ -line passing through  $C$  and is parallel in the euclidean sense to  $AB$ . Notice that through any  $s$ -point not lying on  $AB$  there is one  $s$ -line parallel to  $L$  and through any other  $s$ -point lying on  $AB$  there is no  $s$ -lines parallel to  $L$  such as those shown in Fig.2(a).

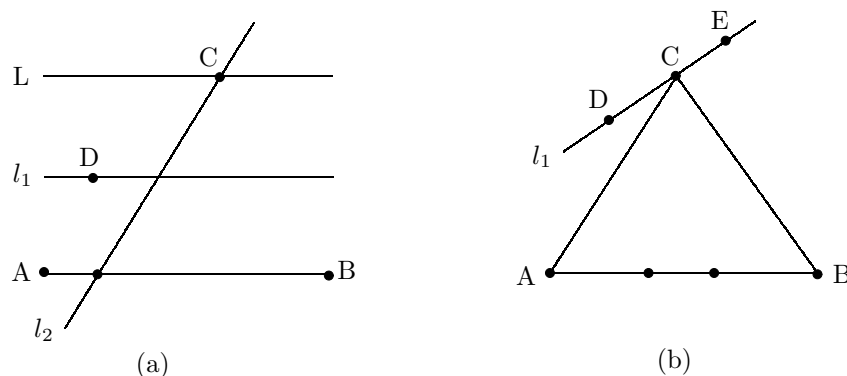

Fig.2

(ii) The axiom that through any two distinct points there exists one line passing through them is now replaced by; *one s-line* and *no s-line*. Notice that through any two distinct  $s$ -points  $D, E$  collinear with one of  $A, B$  and  $C$ , there is one  $s$ -line passing through them and through any two distinct  $s$ -points  $F, G$  lying on  $AB$  or non-collinear with one of  $A, B$  and  $C$ , there is no  $s$ -line passing through them such as those shown in Fig.3.1(b).

A *Smarandache  $n$ -manifold* is an  $n$ -dimensional manifold that supports a Smarandache geometry. Now there are many approaches to construct Smarandache manifolds for  $n = 2$ . A general way is by the so called *map geometries* without or with boundary underlying orientable or non-orientable maps proposed in references [14] and [15] firstly.

**Definition 3.7** For a combinatorial map  $M$  with each vertex valency  $\geq 3$ , endow with a real number  $\mu(u), 0 < \mu(u) < \frac{4\pi}{\rho_M(u)}$ , to each vertex  $u, u \in V(M)$ . Call  $(M, \mu)$  a map geometry without boundary,  $\mu(u)$  an angle factor of the vertex  $u$  and orientable or non-orientable if  $M$  is orientable or not.

**Definition 3.8** For a map geometry  $(M, \mu)$  without boundary and faces  $f_1, f_2, \dots, f_l \in F(M), 1 \leq l \leq \phi(M) - 1$ , if  $S(M) \setminus \{f_1, f_2, \dots, f_l\}$  is connected, then call  $(M, \mu)^{-l} = (S(M) \setminus \{f_1, f_2, \dots, f_l\}, \mu)$  a map geometry with boundary  $f_1, f_2, \dots, f_l$ , where  $S(M)$  denotes the locally orientable surface underlying map  $M$ .

The realization for vertices  $u, v, w \in V(M)$  in a space  $\mathbf{R}^3$  is shown in Fig.3, where  $\rho_M(u)\mu(u) < 2\pi$  for the vertex  $u$ ,  $\rho_M(v)\mu(v) = 2\pi$  for the vertex  $v$  and  $\rho_M(w)\mu(w) > 2\pi$

for the vertex  $w$ , are called to be elliptic, Euclidean or hyperbolic, respectively.

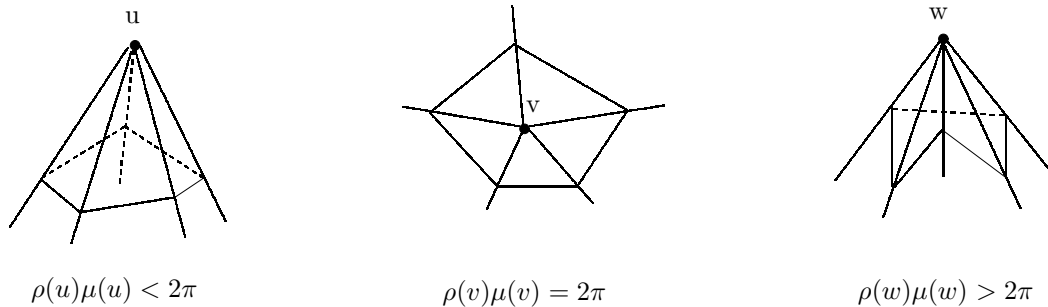

Fig.3

On an Euclid plane  $\mathbf{R}^2$ , a straight line passing through an elliptic or a hyperbolic point is shown in Fig.4.

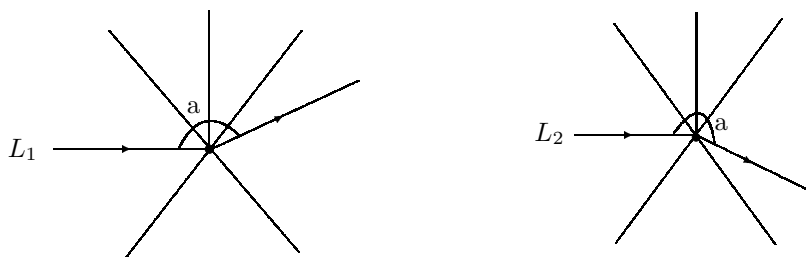

Fig.4

**Theorem 3.5**([17]) *There are Smarandache geometries, including paradoxist geometries, non-geometries and anti-geometries in map geometries without or with boundary.*

Generally, we can ever generalize the ideas in Definitions 3.7 and 3.8 to a metric space and find new geometries.

**Definition 3.9** *Let  $U$  and  $W$  be two metric spaces with metric  $\rho$ ,  $W \subseteq U$ . For  $\forall u \in U$ , if there is a continuous mapping  $\omega : u \rightarrow \omega(u)$ , where  $\omega(u) \in \mathbf{R}^n$  for an integer  $n, n \geq 1$  such that for any number  $\epsilon > 0$ , there exists a number  $\delta > 0$  and a point  $v \in W$ ,  $\rho(u - v) < \delta$  such that  $\rho(\omega(u) - \omega(v)) < \epsilon$ , then  $U$  is called a metric pseudo-space if  $U = W$  or a bounded metric pseudo-space if there is a number  $N > 0$  such that  $\forall w \in W$ ,  $\rho(w) \leq N$ , denoted by  $(U, \omega)$  or  $(U^-, \omega)$ , respectively.*

For the case  $n = 1$ , we can also explain  $\omega(u)$  being an angle function with  $0 < \omega(u) \leq 4\pi$  as in the case of map geometries without or with boundary, i.e.,

$$\omega(u) = \begin{cases} \omega(u)(\text{mod}4\pi), & \text{if } u \in W, \\ 2\pi, & \text{if } u \in U \setminus W \end{cases} \quad (*)$$

and get some interesting metric pseudo-space geometries. For example, let  $U = W = \text{Euclid plane} = \Sigma$ , then we obtained some interesting results for pseudo-plane geometries  $(\Sigma, \omega)$  as shown in the following([17]).

**Theorem 3.6** *In a pseudo-plane  $(\Sigma, \omega)$ , if there are no Euclidean points, then all points of  $(\Sigma, \omega)$  is either elliptic or hyperbolic.*

**Theorem 3.7** *There are no saddle points and stable knots in a pseudo-plane plane  $(\Sigma, \omega)$ .*

**Theorem 3.8** *For two constants  $\rho_0, \theta_0$ ,  $\rho_0 > 0$  and  $\theta_0 \neq 0$ , there is a pseudo-plane  $(\Sigma, \omega)$  with*

$$\omega(\rho, \theta) = 2(\pi - \frac{\rho_0}{\theta_0\rho}) \text{ or } \omega(\rho, \theta) = 2(\pi + \frac{\rho_0}{\theta_0\rho})$$

such that

$$\rho = \rho_0$$

is a limiting ring in  $(\Sigma, \omega)$ .

Now for an  $m$ -manifold  $M^m$  and  $\forall u \in M^m$ , choose  $U = W = M^m$  in Definition 3.9 for  $n = 1$  and  $\omega(u)$  a smooth function. We get a pseudo-manifold geometry  $(M^m, \omega)$  on  $M^m$ . By definitions in the reference [2], a *Minkowski norm* on  $M^m$  is a function  $F : M^m \rightarrow [0, +\infty)$  such that

- (i)  $F$  is smooth on  $M^m \setminus \{0\}$ ;
- (ii)  $F$  is 1-homogeneous, i.e.,  $F(\lambda\bar{u}) = \lambda F(\bar{u})$  for  $\bar{u} \in M^m$  and  $\lambda > 0$ ;
- (iii) for  $\forall y \in M^m \setminus \{0\}$ , the symmetric bilinear form  $g_y : M^m \times M^m \rightarrow R$  with

$$g_y(\bar{u}, \bar{v}) = \frac{1}{2} \frac{\partial^2 F^2(y + s\bar{u} + t\bar{v})}{\partial s \partial t} \Big|_{t=s=0}$$

is positive definite and a *Finsler manifold* is a manifold  $M^m$  endowed with a function  $F : TM^m \rightarrow [0, +\infty)$  such that

- (i)  $F$  is smooth on  $TM^m \setminus \{0\} = \bigcup \{T_{\bar{x}}M^m \setminus \{0\} : \bar{x} \in M^m\}$ ;
- (ii)  $F|_{T_{\bar{x}}M^m} \rightarrow [0, +\infty)$  is a Minkowski norm for  $\forall \bar{x} \in M^m$ .

As a special case, we choose  $\omega(\bar{x}) = F(\bar{x})$  for  $\bar{x} \in M^m$ , then  $(M^m, \omega)$  is a *Finsler manifold*. Particularly, if  $\omega(\bar{x}) = g_{\bar{x}}(y, y) = F^2(x, y)$ , then  $(M^m, \omega)$  is a *Riemann manifold*. Therefore, we get a relation for Smarandache geometries with Finsler or Riemann geometry.

**Theorem 3.9** *There is an inclusion for Smarandache, pseudo-manifold, Finsler and Riemann geometries as shown in the following:*

$$\begin{aligned} \{\text{Smarandache geometries}\} &\supset \{\text{pseudo - manifold geometries}\} \\ &\supset \{\text{Finsler geometry}\} \\ &\supset \{\text{Riemann geometry}\}. \end{aligned}$$



Other purely mathematical results on the combinatorially differential geometry, particularly the combinatorially Riemannian geometry can be found in recently finished papers [20] – [23] of mine.

#### §4. The contribution of combinatorial speculation to theoretical physics

The progress of theoretical physics in last twenty years of the 20th century enables human beings to probe the mystic cosmos: *where are we came from? where are we going to?*. Today, these problems still confuse eyes of human beings. Accompanying with research in cosmos, new puzzling problems also arose: *Whether are there finite or infinite cosmoses? Are there just one? What is the dimension of the Universe? We do not even know what the right degree of freedom in the Universe is*, as Witten said([3]).

We are used to the idea that our living space has three dimensions: *length, breadth and height*, with time providing the fourth dimension of spacetime by Einstein. Applying his principle of general relativity, i.e. *all the laws of physics take the same form in any reference system* and equivalence principle, i.e., *there are no difference for physical effects of the inertial force and the gravitation in a field small enough.*, Einstein got the equation of gravitational field

$$R_{\mu\nu} - \frac{1}{2}Rg_{\mu\nu} + \lambda g_{\mu\nu} = -8\pi GT_{\mu\nu}.$$

where  $R_{\mu\nu} = R_{\nu\mu} = R_{\mu i \nu}^{\alpha}$ ,

$$R_{\mu i \nu}^{\alpha} = \frac{\partial \Gamma_{\mu i}^{\alpha}}{\partial x^{\nu}} - \frac{\partial \Gamma_{\mu \nu}^{\alpha}}{\partial x^i} + \Gamma_{\mu i}^{\alpha} \Gamma_{\alpha \nu}^i - \Gamma_{\mu \nu}^{\alpha} \Gamma_{\alpha i}^i,$$

$$\Gamma_{mn}^g = \frac{1}{2}g^{pq} \left( \frac{\partial g_{mp}}{\partial u^n} + \frac{\partial g_{np}}{\partial u^m} - \frac{\partial g_{mn}}{\partial u^p} \right)$$

and  $R = g^{\nu\mu} R_{\nu\mu}$ .

Combining the Einstein's equation of gravitational field with the *cosmological principle*, i.e., *there are no difference at different points and different orientations at a point of a cosmos on the metric  $10^4$ l.y.*, Friedmann got a standard model of cosmos. The metrics of the standard cosmos are

$$ds^2 = -c^2 dt^2 + a^2(t) \left[ \frac{dr^2}{1 - Kr^2} + r^2 (d\theta^2 + \sin^2 \theta d\phi^2) \right]$$

and

$$g_{tt} = 1, \quad g_{rr} = -\frac{R^2(t)}{1 - Kr^2}, \quad g_{\phi\phi} = -r^2 R^2(t) \sin^2 \theta.$$

The standard model of cosmos enables the birth of big bang model of the Universe in thirties of the 20th century. The following diagram describes the developing process of the Universe in different periods after the Big Bang.

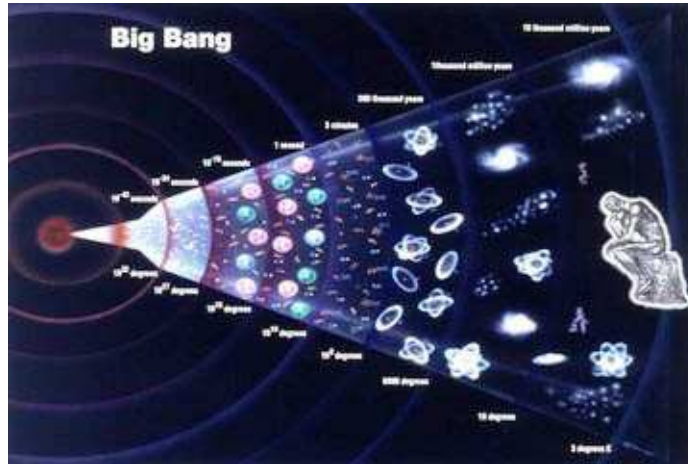

Fig.5

#### 4.1. The M-theory

The M-theory was established by Witten in 1995 for the unity of those five already known string theories and superstring theories, which postulates that all matter and energy can be reduced to *branes* of energy vibrating in an 11 dimensional space, then in a higher dimensional space solve the Einstein's equation of gravitational field under some physical conditions ([1],[3],[26]-[27]). Here, a *brane* is an object or subspace which can have various spatial dimensions. For any integer  $p \geq 0$ , a  $p$ -*brane* has length in  $p$  dimensions. For example, a 0-*brane* is just a point or particle; a 1-*brane* is a string and a 2-*brane* is a surface or membrane,  $\dots$ .

We mainly discuss line elements in differential forms in Riemann geometry. By a geometrical view, these  $p$ -branes in M-theory can be seen as *volume elements in spaces*. Whence, we can construct a graph model for  $p$ -branes in a space and combinatorially research graphs in spaces.

**Definition 4.1** For each  $m$ -brane  $\mathbf{B}$  of a space  $\mathbf{R}^m$ , let  $(n_1(\mathbf{B}), n_2(\mathbf{B}), \dots, n_p(\mathbf{B}))$  be its unit vibrating normal vector along these  $p$  directions and  $q : \mathbf{R}^m \rightarrow \mathbf{R}^4$  a continuous mapping. Now construct a graph phase  $(\mathcal{G}, \omega, \Lambda)$  by

$$V(\mathcal{G}) = \{p\text{-branes } q(\mathbf{B})\},$$

$$E(\mathcal{G}) = \{(q(\mathbf{B}_1), q(\mathbf{B}_2)) | \text{there is an action between } \mathbf{B}_1 \text{ and } \mathbf{B}_2\},$$

$$\omega(q(\mathbf{B})) = (n_1(\mathbf{B}), n_2(\mathbf{B}), \dots, n_p(\mathbf{B})),$$

and

$$\Lambda(q(\mathbf{B}_1), q(\mathbf{B}_2)) = \text{forces between } \mathbf{B}_1 \text{ and } \mathbf{B}_2.$$

Then we get a graph phase  $(\mathcal{G}, \omega, \Lambda)$  in  $\mathbf{R}^4$ . Similarly, if  $m = 11$ , it is a graph phase for the

*M-theory.*

As an example for applying M-theory to find an accelerating expansion cosmos of 4-dimensional cosmoses from supergravity compactification on hyperbolic spaces is the *Townsend-Wohlfarth type metric* in which the line element is

$$ds^2 = e^{-m\phi(t)}(-S^6 dt^2 + S^2 dx_3^2) + r_c^2 e^{2\phi(t)} ds_{H_m}^2,$$

where

$$\phi(t) = \frac{1}{m-1}(\ln K(t) - 3\lambda_0 t),$$

$$S^2 = K^{\frac{m}{m-1}} e^{-\frac{m+2}{m-1}\lambda_0 t}$$

and

$$K(t) = \frac{\lambda_0 \zeta r_c}{(m-1) \sin[\lambda_0 \zeta |t + t_1|]}$$

with  $\zeta = \sqrt{3 + 6/m}$ . This solution is obtainable from space-like brane solution and if the proper time  $\varsigma$  is defined by  $d\varsigma = S^3(t)dt$ , then the conditions for expansion and acceleration are  $\frac{dS}{d\varsigma} > 0$  and  $\frac{d^2S}{d\varsigma^2} > 0$ . For example, the expansion factor is 3.04 if  $m = 7$ , i.e., a really expanding cosmos.

According to M-theory, the evolution picture of our cosmos started as a perfect 11 dimensional space. However, this 11 dimensional space was unstable. The original 11 dimensional space finally cracked into two pieces, a 4 and a 7 dimensional subspaces. The cosmos made the 7 of the 11 dimensions curled into a tiny ball, allowing the remaining 4 dimensions to inflate at enormous rates, the Universe at the final.

#### 4.2. The combinatorial cosmos

The combinatorial speculation made the following combinatorial cosmos in the reference [17].

**Definition 4.2** *A combinatorial cosmos is constructed by a triple  $(\Omega, \Delta, T)$ , where*

$$\Omega = \bigcup_{i \geq 0} \Omega_i, \quad \Delta = \bigcup_{i \geq 0} O_i$$

and  $T = \{t_i; i \geq 0\}$  are respectively called the cosmos, the operation or the time set with the following conditions hold.

(1)  $(\Omega, \Delta)$  is a Smarandache multi-space dependent on  $T$ , i.e., the cosmos  $(\Omega_i, O_i)$  is dependent on time parameter  $t_i$  for any integer  $i, i \geq 0$ .

(2) For any integer  $i, i \geq 0$ , there is a sub-cosmos sequence

$$(S) : \Omega_i \supset \cdots \supset \Omega_{i1} \supset \Omega_{i0}$$

in the cosmos  $(\Omega_i, O_i)$  and for two sub-cosmoses  $(\Omega_{ij}, O_i)$  and  $(\Omega_{il}, O_i)$ , if  $\Omega_{ij} \supset \Omega_{il}$ , then there is a homomorphism  $\rho_{\Omega_{ij}, \Omega_{il}} : (\Omega_{ij}, O_i) \rightarrow (\Omega_{il}, O_i)$  such that

(i) for  $\forall(\Omega_{i1}, O_i), (\Omega_{i2}, O_i), (\Omega_{i3}, O_i) \in (S)$ , if  $\Omega_{i1} \supset \Omega_{i2} \supset \Omega_{i3}$ , then

$$\rho_{\Omega_{i1}, \Omega_{i3}} = \rho_{\Omega_{i1}, \Omega_{i2}} \circ \rho_{\Omega_{i2}, \Omega_{i3}},$$

where  $\circ$  denotes the composition operation on homomorphisms.

(ii) for  $\forall g, h \in \Omega_i$ , if for any integer  $i$ ,  $\rho_{\Omega, \Omega_i}(g) = \rho_{\Omega, \Omega_i}(h)$ , then  $g = h$ .

(iii) for  $\forall i$ , if there is an  $f_i \in \Omega_i$  with

$$\rho_{\Omega_i, \Omega_i \cap \Omega_j}(f_i) = \rho_{\Omega_j, \Omega_i \cap \Omega_j}(f_j)$$

for integers  $i, j, \Omega_i \cap \Omega_j \neq \emptyset$ , then there exists an  $f \in \Omega$  such that  $\rho_{\Omega, \Omega_i}(f) = f_i$  for any integer  $i$ .

By this definition, there is just one cosmos  $\Omega$  and the sub-cosmos sequence is

$$\mathbf{R}^4 \supset \mathbf{R}^3 \supset \mathbf{R}^2 \supset \mathbf{R}^1 \supset \mathbf{R}^0 = \{P\} \supset \mathbf{R}_7^- \supset \dots \supset \mathbf{R}_1^- \supset \mathbf{R}_0^- = \{Q\}.$$

in the string/M-theory. In Fig.6, we have shown the idea of the combinatorial cosmos.

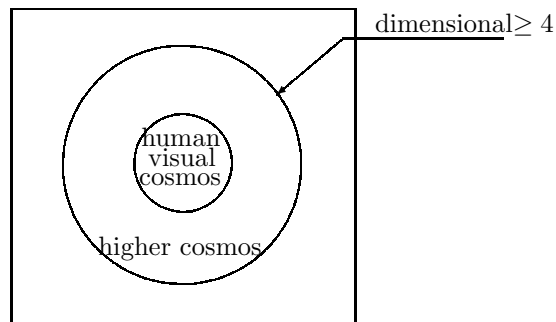

**Fig.6**

For 5 or 6 dimensional spaces, it has been established a dynamical theory by this combinatorial speculation([24]-[25]). In this dynamics, we look for a solution in the Einstein's equation of gravitational field in 6-dimensional spacetime with a metric of the form

$$ds^2 = -n^2(t, y, z)dt^2 + a^2(t, y, z)d \sum_k^2 + b^2(t, y, z)dy^2 + d^2(t, y, z)dz^2$$

where  $d \sum_k^2$  represents the 3-dimensional spatial sections metric with  $k = -1, 0, 1$  respective corresponding to the hyperbolic, flat and elliptic spaces. For 5-dimensional spacetime, deletes the indefinite  $z$  in this metric form. Now consider a 4-brane moving in a 6-dimensional *Schwarzschild-ADS spacetime*, the metric can be written as

$$ds^2 = -h(z)dt^2 + \frac{z^2}{l^2}d \sum_k^2 + h^{-1}(z)dz^2,$$

where

$$d \sum_k^2 = \frac{dr^2}{1 - kr^2} + r^2 d\Omega_{(2)}^2 + (1 - kr^2) dy^2$$

and

$$h(z) = k + \frac{z^2}{l^2} - \frac{M}{z^3}.$$

Then the equation of a 4-dimensional cosmos moving in a 6-spacetime is

$$2 \frac{\ddot{R}}{R} + 3 \left(\frac{\dot{R}}{R}\right)^2 = -3 \frac{\kappa_{(6)}^4}{64} \rho^2 - \frac{\kappa_{(6)}^4}{8} \rho p - 3 \frac{\kappa}{R^2} - \frac{5}{l^2}$$

by applying the *Darmois-Israel conditions* for a moving brane. Similarly, for the case of  $a(z) \neq b(z)$ , the equations of motion of the brane are

$$\frac{d^2 \dot{R} - d\ddot{R}}{\sqrt{1 + d^2 \dot{R}^2}} - \frac{\sqrt{1 + d^2 \dot{R}^2}}{n} \left( d\dot{n} \dot{R} + \frac{\partial_z n}{d} - (d\partial_z n - n\partial_z d) \dot{R}^2 \right) = -\frac{\kappa_{(6)}^4}{8} (3(p + \hat{p}) + \hat{p}),$$

$$\frac{\partial_z a}{ad} \sqrt{1 + d^2 \dot{R}^2} = -\frac{\kappa_{(6)}^4}{8} (\rho + p - \hat{p}),$$

$$\frac{\partial_z b}{bd} \sqrt{1 + d^2 \dot{R}^2} = -\frac{\kappa_{(6)}^4}{8} (\rho - 3(p - \hat{p})),$$

where the energy-momentum tensor on the brane is

$$\hat{T}_{\mu\nu} = h_{\nu\alpha} T_{\mu}^{\alpha} - \frac{1}{4} T h_{\mu\nu}$$

with  $T_{\mu}^{\alpha} = \text{diag}(-\rho, p, p, p, \hat{p})$  and the *Darmois-Israel conditions*

$$[K_{\mu\nu}] = -\kappa_{(6)}^2 \hat{T}_{\mu\nu},$$

where  $K_{\mu\nu}$  is the extrinsic curvature tensor.

The combinatorial cosmos also presents new questions to combinatorics, such as:

- (i) to embed a graph into spaces with dimensional  $\geq 4$ ;
- (ii) to research the phase space of a graph embedded in a space;
- (iii) to establish graph dynamics in a space with dimensional  $\geq 4$ ,  $\dots$ , etc..

For example, we have gotten the following result for graphs in spaces in [17].

**Theorem 4.1** *A graph  $G$  has a nontrivial including multi-embedding on spheres  $P_1 \supset P_2 \supset \dots \supset P_s$  if and only if there is a block decomposition  $G = \bigsqcup_{i=1}^s G_i$  of  $G$  such that for any integer  $i, 1 < i < s$ ,*

(i)  $G_i$  is planar;

(ii) for  $\forall v \in V(G_i), N_G(x) \subseteq \left( \bigcup_{j=i-1}^{i+1} V(G_j) \right)$ .

Further research of the combinatorial cosmos will richen the knowledge of combinatorics

and cosmology, also get the combinatorialization for cosmology.

## References

- [1] I.Antoniadis, Physics with large extra dimensions: String theory under experimental test, *Current Science*, Vol.81, No.12, 25(2001),1609-1613
- [2] S.S.Chern and W.H.Chern, *Lectures in Differential Geometry*(in Chinese), Peking University Press, 2001.
- [3] M.J.Duff, A layman's guide to M-theory, *arXiv: hep-th/9805177*, v3, 2 July(1998).
- [4] B.J.Fei, *Relativity Theory and Non-Euclid Geometries*, Science Publisher Press, Beijing, 2005.
- [5] U.Günther and A.Zhuk, Phenomenology of brane-world cosmological models, *arXiv: gr-qc/0410130*.
- [6] S.Hawking, *A Brief History of Times*, A Bantam Books/November, 1996.
- [7] S.Hawking, *The Universe in Nutshell*, A Bantam Books/November, 2001.
- [8] D.Ida, Brane-world cosmology, *arXiv: gr-qc/9912002*.
- [9] H.Iseri, *Smarandache Manifolds*, American Research Press, Rehoboth, NM,2002.
- [10] H.Iseri, *Partially Paradoxist Smarandache Geometries*, <http://www.gallup.unm.edu/~smarandache/Howard-Iseri-paper.htm>.
- [11] M.Kaku, *Hyperspace: A Scientific Odyssey through Parallel Universe, Time Warps and 10th Dimension*, Oxford Univ. Press.
- [12] P.Kanti, R.Madden and K.A.Olive, A 6-D brane world model, *arXiv: hep-th/0104177*.
- [13] L.Kuciuk and M.Antholy, An Introduction to Smarandache Geometries, *Mathematics Magazine, Aurora, Canada*, Vol.12(2003)
- [14] L.F.Mao, *On Automorphisms groups of Maps, Surfaces and Smarandache geometries, Scientia Magna*, Vol.1(2005), No.2, 55-73.
- [15] L.F.Mao, A new view of combinatorial maps by Smarandache's notion, in *Selected Papers on Mathematical Combinatorics(I)*, World Academic Union, 2006, also in *arXiv: math.GM/0506232*.
- [16] L.F.Mao, *Automorphism Groups of Maps, Surfaces and Smarandache Geometries*, American Research Press, 2005.
- [17] L.F.Mao, *Smarandache multi-space theory*, Hexis, Phoenix, AZ2006.
- [18] L.F.Mao, On algebraic multi-groups, *Scientia Magna*, Vol.2(2006), No.1, 64-70.
- [19] L.F.Mao, On multi-metric spaces, *Scientia Magna*, Vol.2(2006), No.1, 87-94.
- [20] L.F.Mao, Geometrical theory on combinatorial manifolds, *JP J.Geometry and Topology*, Vol.7, No.1(2007),65-114.
- [21] L.F.Mao, An introduction to Smarandache multi-spaces and mathematical combinatorics, *Scientia Magna*, Vol.3, No.1(2007), 54-80.
- [22] L.F.Mao, A combinatorially generalized Stokes' theorem on integrations, *International J.Mathematical Combinatorics*, Vol.1, No.1(2007),67-86.
- [23] L.F.Mao, Curvature equations on combinatorial manifolds with applications to theoretical physics, *International J.Mathematical Combinatorics* (accepted).

- [24] E.Papantonopoulos, Braneworld cosmological models, *arXiv: gr-qc/0410032*.
- [25] E.Papantonopoulos, Cosmology in six dimensions, *arXiv: gr-qc/0601011*.
- [26] J.A.Peacock, *Cosmological Physics*, Cambridge University Press, 2003.
- [27] J.Polchinski, *String Theory*, Vol.1-Vol.2, Cambridge University Press, 2003.
- [28] D.Rabounski, Declaration of academic freedom: Scientific Human Rights, *Progress in Physics*, January (2006), Vol.1, 57-60.
- [29] F.Smarandache, Mixed non-euclidean geometries, *eprint arXiv: math/0010119*, 10/2000.
- [30] F.Smarandache, *A Unifying Field in Logics. Neutrosophy: Neutrosophic Probability, Set, and Logic*, American research Press, Rehoboth, 1999.
- [31] F.Smarandache, Neutrosophy, a new Branch of Philosophy, *Multi-Valued Logic*, Vol.8, No.3(2002)(special issue on Neutrosophy and Neutrosophic Logic), 297-384.
- [32] F.Smarandache, A Unifying Field in Logic: Neutrosophic Field, *Multi-Valued Logic*, Vol.8, No.3(2002)(special issue on Neutrosophy and Neutrosophic Logic), 385-438.
- [33] J.Stillwell, *Classical topology and combinatorial group theory*, Springer-Verlag New York Inc., (1980).

## Combinatorial Mathematics After CC Conjecture

### — Combinatorial Notions and Achievements

**Abstract:** As a powerful technique for holding relations in things, combinatorics has experienced rapidly development in the past century, particularly, enumeration of configurations, combinatorial design and graph theory. However, the main objective for mathematics is to bring about a quantitative analysis for other sciences, which implies a natural question on combinatorics. Thus, *how combinatorics can contribute to other mathematical sciences, not just in discrete mathematics, but metric mathematics and physics?* After a long time speculation, I brought the CC conjecture for advancing mathematics by combinatorics, i.e., *any mathematical science can be reconstructed from or made by combinatorialization* in my postdoctoral report for Chinese Academy of Sciences in 2005, and reported it at a few academic conferences in China. After then, my surveying paper *Combinatorial Speculation and Combinatorial Conjecture for Mathematics* published in the first issue of *International Journal of Mathematical Combinatorics*, 2007. Clearly, CC conjecture is in fact a combinatorial notion and holds by a philosophical law, i.e., all things are inherently related, not isolated but it can greatly promote the developing of mathematical sciences. The main purpose of this report is to survey the roles of CC conjecture in developing mathematical sciences with notions, such as those of its contribution to algebra, topology, Euclidean geometry and differential geometry, non-solvable differential equations or classical mathematical systems with contradictions to mathematics, quantum fields after it appeared 10 years ago. All of these show the importance of combinatorics to mathematical sciences in the past and future.

**Key Words:** CC conjecture, Smarandache system,  $G^L$ -system, non-solvable system of equations, combinatorial manifold, geometry, quantum field.

**AMS(2010):** 03C05,05C15,51D20,51H20,51P05,83C05,83E50.

### §1. Introduction

There are many techniques in combinatorics, particularly, the enumeration and counting with graph, a visible, also an abstract model on relations of things in the world. Among them, the most interested is the graph. A graph  $G$  is a 3-tuple  $(V, E, I)$  with finite sets  $V, E$  and a mapping  $I : E \rightarrow V \times V$ , and *simple* if it is without loops and multiple edges, denoted by  $(V; E)$  for convenience. All elements  $v$  in  $V$ ,  $e$  in  $E$  are said respectively *vertices* and *edges*.

A graph with given properties are particularly interested. For example, a *path*  $P_n$  in a graph  $G$  is an alternating sequence of vertices and edges  $u_1, e_1, u_2, e_2, \dots, e_n, u_{n+1}$ ,  $e_i = (u_i, u_{i+1})$  with

---

<sup>1</sup>A plenary talk in the *International Conference on Combinatorics, Graph Theory, Topology and Geometry*, January 29-31, 2015, Shanghai, P.R.China.

<sup>2</sup>*International J.Math.Combin.*, Vol.2(2015), 1-31.



distinct vertices for an integer  $n \geq 1$ , and if  $u_1 = u_{n+1}$ , it is called a *circuit* or *cycle*  $C_n$ . For example,  $v_1v_2v_3v_4$  and  $v_1v_2v_3v_4v_1$  are respective path and circuit in Fig.1. A graph  $G$  is *connected* if for  $u, v \in V(G)$ , there are paths with end vertices  $u$  and  $v$  in  $G$ .

A *complete graph*  $K_n = (V_c, E_c; I_c)$  is a simple graph with  $V_c = \{v_1, v_2, \dots, v_n\}$ ,  $E_c = \{e_{ij}, 1 \leq i, j \leq n, i \neq j\}$  and  $I_c(e_{ij}) = (v_i, v_j)$ , or simply by a pair  $(V, E)$  with  $V = \{v_1, v_2, \dots, v_n\}$  and  $E = \{v_iv_j, 1 \leq i, j \leq n, i \neq j\}$ .

A simple graph  $G = (V, E)$  is *r-partite* for an integer  $r \geq 1$  if it is possible to partition  $V$  into  $r$  subsets  $V_1, V_2, \dots, V_r$  such that for  $\forall e(u, v) \in E$ , there are integers  $i \neq j, 1 \leq i, j \leq r$  such that  $u \in V_i$  and  $v \in V_j$ . If there is an edge  $e_{ij} \in E$  for  $\forall v_i \in V_i, \forall v_j \in V_j$ , where  $1 \leq i, j \leq r, i \neq j$ , then,  $G$  is called a *complete r-partite graph*, denoted by  $G = K(|V_1|, |V_2|, \dots, |V_r|)$ . Thus a complete graph is nothing else but a complete 1-partite graph. For example, the bipartite graph  $K(4, 4)$  and the complete graph  $K_6$  are shown in Fig.1.

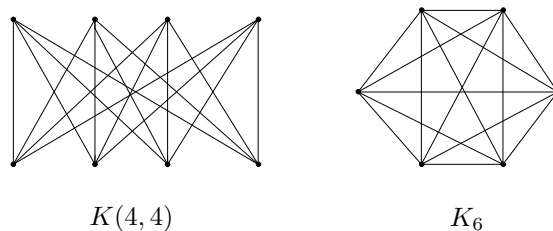

Fig.1

Notice that a few edges in Fig.1 have intersections besides end vertices. Contrast to this case, a *planar graph* can be realized on a Euclidean plane  $\mathbb{R}^2$  by letting points  $p(v) \in \mathbb{R}^2$  for vertices  $v \in V$  with  $p(v_i) \neq p(v_j)$  if  $v_i \neq v_j$ , and letting curve  $C(v_i, v_j) \subset \mathbb{R}^2$  connecting points  $p(v_i)$  and  $p(v_j)$  for edges  $(v_i, v_j) \in E(G)$ , such as those shown in Fig.2.

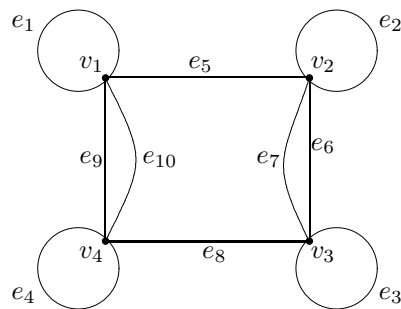

Fig.2

Generally, let  $\mathcal{E}$  be a topological space. A graph  $G$  is said to be *embeddable* into  $\mathcal{E}$  ([32]) if there is a 1 – 1 continuous mapping  $f : G \rightarrow \mathcal{E}$  with  $f(p) \neq f(q)$  if  $p \neq q$  for  $\forall p, q \in G$ , i.e., edges only intersect at vertices in  $\mathcal{E}$ . Such embedded graphs are called *topological graphs*.

There is a well-known result on embedding of graphs without loops and multiple edges in  $\mathbb{R}^n$  for  $n \geq 3$  ([32]), i.e., *there always exists such an embedding of  $G$  that all edges are straight segments in  $\mathbb{R}^n$* , which enables us turn to characterize embeddings of graphs on  $\mathbb{R}^2$  and its

generalization, 2-manifolds or surfaces ([3]).

However, all these embeddings of  $G$  are established on an assumption that *each vertex of  $G$  is mapped exactly into one point of  $\mathcal{E}$*  in combinatorics for simplicity. If we put off this assumption, *what will happens? Are these resultants important for understanding the world?* The answer is certainly YES because this will enables us to pullback more characters of things, characterize more precisely and then hold the truly faces of things in the world.

All of us know an objective law in philosophy, namely, *the integral always consists of its parts and all of them are inherently related, not isolated.* This idea implies that every thing in the world is nothing else but a union of sub-things underlying a graph embedded in space of the world.

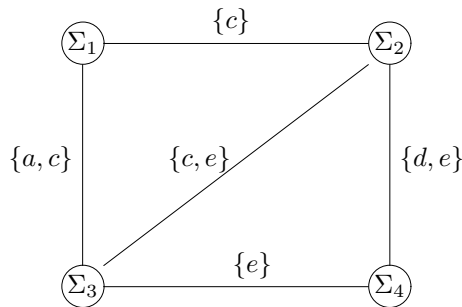

Fig.3

Formally, we introduce some conceptions following.

**Definition 1.1**([30]-[31], [12]) *Let  $(\Sigma_1; \mathcal{R}_1), (\Sigma_2; \mathcal{R}_2), \dots, (\Sigma_m; \mathcal{R}_m)$  be  $m$  mathematical systems, different two by two. A Smarandache multisystem  $\tilde{\Sigma}$  is a union  $\bigcup_{i=1}^m \Sigma_i$  with rules*

$$\tilde{\mathcal{R}} = \bigcup_{i=1}^m \mathcal{R}_i \text{ on } \tilde{\Sigma}, \text{ denoted by } (\tilde{\Sigma}; \tilde{\mathcal{R}}).$$

**Definition 1.2**([11]-[13]) *For any integer  $m \geq 1$ , let  $(\tilde{\Sigma}; \tilde{\mathcal{R}})$  be a Smarandache multisystem consisting of  $m$  mathematical systems  $(\Sigma_1; \mathcal{R}_1), (\Sigma_2; \mathcal{R}_2), \dots, (\Sigma_m; \mathcal{R}_m)$ . An inherited topological structure  $G^L [\tilde{\Sigma}; \tilde{\mathcal{R}}]$  of  $(\tilde{\Sigma}; \tilde{\mathcal{R}})$  is a topological vertex-edge labeled graph defined following:*

$$\begin{aligned} V(G^L [\tilde{\Sigma}; \tilde{\mathcal{R}}]) &= \{\Sigma_1, \Sigma_2, \dots, \Sigma_m\}, \\ E(G^L [\tilde{\Sigma}; \tilde{\mathcal{R}}]) &= \{(\Sigma_i, \Sigma_j) | \Sigma_i \cap \Sigma_j \neq \emptyset, 1 \leq i \neq j \leq m\} \text{ with labeling} \\ L : \Sigma_i &\rightarrow L(\Sigma_i) = \Sigma_i \quad \text{and} \quad L : (\Sigma_i, \Sigma_j) \rightarrow L(\Sigma_i, \Sigma_j) = \Sigma_i \cap \Sigma_j \end{aligned}$$

for integers  $1 \leq i \neq j \leq m$ , also denoted by  $G^L [\tilde{\Sigma}; \tilde{\mathcal{R}}]$  for  $(\tilde{\Sigma}; \tilde{\mathcal{R}})$ .

For example, let  $\Sigma_1 = \{a, b, c\}$ ,  $\Sigma_2 = \{c, d, e\}$ ,  $\Sigma_3 = \{a, c, e\}$ ,  $\Sigma_4 = \{d, e, f\}$  and  $\mathcal{R}_i = \emptyset$  for integers  $1 \leq i \leq 4$ , i.e., all these system are sets. Then the multispace  $(\tilde{\Sigma}; \tilde{\mathcal{R}})$  with  $\tilde{\Sigma} = \bigcup_{i=1}^4 \Sigma_i = \{a, b, c, d, e, f\}$  and  $\tilde{\mathcal{R}} = \emptyset$  underlying a topological graph  $G^L [\tilde{\Sigma}; \tilde{\mathcal{R}}]$  shown in Fig.3. Combinatorially, the Smarandache multisystems can be classified by their inherited

topological structures, i.e., isomorphic labeled graphs following.

**Definition 1.3** ([13]) *Let*

$$G_1^{L_1} = \left( \bigcup_{i=1}^m \Sigma_i^{(1)}; \bigcup_{i=1}^m \mathcal{R}_i^{(1)} \right) \quad \text{and} \quad G_2^{L_2} = \left( \bigcup_{i=1}^n \Sigma_i^{(2)}; \bigcup_{i=1}^n \mathcal{R}_i^{(2)} \right).$$

*be two Smarandache multisystems underlying topological graphs  $G_1$  and  $G_2$ , respectively. They are isomorphic if there is a bijection  $\varpi : G_1^{L_1} \rightarrow G_2^{L_2}$  with  $\varpi : \bigcup_{i=1}^m \Sigma_i^{(1)} \rightarrow \bigcup_{i=1}^n \Sigma_i^{(2)}$  and*

*$\varpi : \bigcup_{i=1}^m \mathcal{R}_i^{(1)} \rightarrow \bigcup_{i=1}^n \mathcal{R}_i^{(2)}$  such that*

$$\varpi|_{\Sigma_i} \left( a\mathcal{R}_i^{(1)}b \right) = \varpi|_{\Sigma_i}(a)\varpi|_{\Sigma_i} \left( \mathcal{R}_i^{(1)} \right) \varpi|_{\Sigma_i}(b)$$

*for  $\forall a, b \in \Sigma_i^{(1)}$ ,  $1 \leq i \leq m$ , where  $\varpi|_{\Sigma_i}$  denotes the constraint of  $\varpi$  on  $(\Sigma_i, \mathcal{R}_i)$ .*

Consequently, the previous discussion implies that

*Every thing in the world is nothing else but a topological graph  $G^L$  in space of the world, and two things are similar if they are isomorphic.*

After speculation over a long time, I presented the CC conjecture on mathematical sciences in the final chapter of my post-doctoral report for *Chinese Academy of Sciences* in 2005 ([9],[10]), and then reported at *The 2<sup>nd</sup> Conference on Combinatorics and Graph Theory of China* in 2006, which is in fact an inverse of the understand of things in the world.

**CC Conjecture**([9-10],[14]) *Any mathematical science can be reconstructed from or made by combinatorialization.*

Certainly, this conjecture is true in philosophy. It is in fact a *combinatorial notion* for developing mathematical sciences following.

**Notion 1.1** *Finds the combinatorial structure, particularly, selects finite combinatorial rulers to reconstruct or make a generalization for a classical mathematical science.*

This notion appeared even in classical mathematics. For examples, Hilbert axiom system for Euclidean geometry, complexes in algebraic topology, particularly, 2-cell embeddings of graphs on surface are essentially the combinatorialization for Euclidean geometry, topological spaces and surfaces, respectively.

**Notion 1.2** *Combine different mathematical sciences and establish new enveloping theory on topological graphs, with classical theory being a special one, and this combinatorial process will never end until it has been done for all mathematical sciences.*

A few fields can be also found in classical mathematics on this notion, for instance the topological groups, which is in fact a multi-space of topological space with groups, and similarly, the Lie groups, a multi-space of manifold with that of diffeomorphisms.

Even in the developing process of physics, the trace of Notions 1.1 and 1.2 can be also

found. For examples, the many-world interpretation [2] on quantum mechanics by Everett in 1957 is essentially a multispace formulation of quantum state (See [35] for details), and the unifying the four known forces, i.e., gravity, electro-magnetism, the strong and weak nuclear force into one super force by many researchers, i.e., establish the *unified field theory* is nothing else but also a following of the combinatorial notions by letting Lagrangian  $\mathcal{L}$  being that a combination of its subfields, for instance the *standard model* on electroweak interactions, etc..

Even so, the CC conjecture includes more deeply thoughts for developing mathematics by combinatorics i.e., *mathematical combinatorics* which extends the field of all existent mathematical sciences. After it was presented, more methods were suggested for developing mathematics in last decade. The main purpose of this report is to survey its contribution to algebra, topology and geometry, mathematical analysis, particularly, non-solvable algebraic and differential equations, theoretical physics with its producing notions in developing mathematical sciences.

All terminologies and notations used in this paper are standard. For those not mentioned here, we follow reference [5] and [32] for topology, [3] for topological graphs, [1] for algebraic systems, [4], [34] for differential equations and [12], [30]-[31] for Smarandache systems.

## §2. Algebraic Combinatorics

Algebraic systems, such as those of groups, rings, fields and modules are combinatorial themselves. However, the CC conjecture also produces notions for their development following.

**Notion 2.1** For an algebraic system  $(\mathcal{A}; \mathcal{O})$ , determine its underlying topological structure  $G^L[\mathcal{A}, \mathcal{O}]$  on subsystems, and then classify by graph isomorphism.

**Notion 2.2** For an integer  $m \geq 1$ , let  $(\Sigma_1; \mathcal{R}_1), (\Sigma_2; \mathcal{R}_2), \dots, (\Sigma_m; \mathcal{R}_m)$  all be algebraic systems in Definition 1.2 and  $(\tilde{\mathcal{G}}; \mathcal{O})$  underlying  $G^L[\tilde{\mathcal{G}}; \mathcal{O}]$  with  $\tilde{\mathcal{G}} = \bigcup_{i=1}^m \Sigma_i$  and  $\mathcal{O} = \bigcup_{i=1}^m \mathcal{R}_i$ , i.e., an algebraic multisystem. Characterize  $(\tilde{\mathcal{G}}; \mathcal{O})$  and establish algebraic theory, i.e., combinatorial algebra on  $(\tilde{\mathcal{G}}; \mathcal{O})$ .

For example, let

$$\begin{aligned}\langle \mathcal{G}_1; \circ_1 \rangle &= \langle a, b | a \circ_1 b = b \circ_1 a, a^2 = b^n = 1 \rangle \\ \langle \mathcal{G}_2; \circ_2 \rangle &= \langle b, c | b \circ_2 c = c \circ_2 b, c^5 = b^n = 1 \rangle \\ \langle \mathcal{G}_3; \circ_3 \rangle &= \langle c, d | c \circ_3 d = d \circ_3 c, d^2 = c^5 = 1 \rangle\end{aligned}$$

be groups with respective operations  $\circ_1, \circ_2$  and  $\circ_3$ . Then the set  $(\tilde{\mathcal{G}}; \{\circ_1, \circ_2, \circ_3\})$  is an algebraic multisystem with  $\tilde{\mathcal{G}} = \bigcup_{i=1}^3 \mathcal{G}_i$ .

### 2.1 $K_2^L$ -Systems

A  $K_2^L$ -system is such a multi-system consisting of exactly 2 algebraic systems underlying a topological graph  $K_2^L$ , including bigroups, birings, bifields and bimodules, etc.. For example, an

algebraic field  $(R; +, \cdot)$  is a  $K_2^L$ -system. Clearly,  $(R; +, \cdot)$  consists of groups  $(R; +)$  and  $(R \setminus \{0\}; \cdot)$  underlying  $K_2^L$  such as those shown in Fig.4, where  $L : V(K_2^L) \rightarrow \{(R; +), (R \setminus \{0\}; \cdot)\}$  and  $L : E(K_2^L) \rightarrow \{R \setminus \{0\}\}$ .

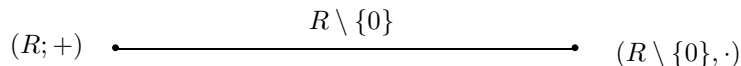

Fig.4

A generalization of field is replace  $R \setminus \{0\}$  by any subset  $H \leq R$  in Fig.4. Then a bigroup comes into being, which was introduced by Maggu [8] for industrial systems in 1994, and then Vasantha Kandasmy [33] further generalizes it to bialgebraic structures.

**Definition 2.3** A bigroup (biring, bifield, bimodule, ...) is a 2-system  $(\mathcal{G}; \circ, \cdot)$  such that

- (1)  $\mathcal{G} = \mathcal{G}_1 \cup \mathcal{G}_2$ ;
- (2)  $(\mathcal{G}_1; \circ)$  and  $(\mathcal{G}_2; \cdot)$  both are groups (rings, fields, modules, ...).

For example, let  $\widetilde{\mathcal{P}}$  be a permutation multigroup action on  $\widetilde{\Omega}$  with

$$\widetilde{\mathcal{P}} = \mathcal{P}_1 \cup \mathcal{P}_2 \quad \text{and} \quad \widetilde{\Omega} = \{1, 2, 3, 4, 5, 6, 7, 8\} \cup \{1, 2, 5, 6, 9, 10, 11, 12\},$$

where  $\mathcal{P}_1 = \langle (1, 2, 3, 4), (5, 6, 7, 8) \rangle$  and  $\mathcal{P}_2 = \langle (1, 5, 9, 10), (2, 6, 11, 12) \rangle$ . Clearly,  $\widetilde{\mathcal{P}}$  is a permutation bigroup.

Let  $(\mathcal{G}_1; \circ_1, \cdot_1)$  and  $(\mathcal{G}_2; \circ_2, \cdot_2)$  be bigroups. A mapping pair  $(\phi, \iota)$  with  $\phi : \mathcal{G}_1 \rightarrow \mathcal{G}_2$  and  $\iota : \{\circ_1, \cdot_1\} \rightarrow \{\circ_2, \cdot_2\}$  is a *homomorphism* if

$$\phi(a \bullet b) = \phi(a)\iota(\bullet)\phi(b)$$

for  $\forall a, b \in \mathcal{G}_1$  and  $\bullet \in \{\circ_1, \cdot_1\}$  provided  $a \bullet b$  existing in  $(\mathcal{G}_1; \circ_1, \cdot_1)$ . Define the *image*  $\text{Im}(\phi, \iota)$  and *kernel*  $\text{Ker}(\phi, \iota)$  respectively by

$$\begin{aligned} \text{Im}(\phi, \iota) &= \{ \phi(g) \mid g \in \mathcal{G}_1 \}, \\ \text{Ker}(\phi, \iota) &= \{ g \in \mathcal{G}_1 \mid \phi(g) = 1_\bullet, \forall \bullet \in \{\circ_2, \cdot_2\} \}, \end{aligned}$$

where  $1_\bullet$  denotes the unit of  $(\mathcal{G}_\bullet; \bullet)$  with  $\mathcal{G}_\bullet$  a maximal closed subset of  $\mathcal{G}$  on operation  $\bullet$ .

For subsets  $\widetilde{H} \subset \widetilde{G}$ ,  $O \subset \mathcal{O}$ , define  $(\widetilde{H}; O)$  to be a submultisystem of  $(\widetilde{G}; \mathcal{O})$  if  $(\widetilde{H}; O)$  is multisystem itself, denoted by  $(\widetilde{H}; O) \leq (\widetilde{G}; \mathcal{O})$ , and a subbigroup  $(\mathcal{H}; \circ, \cdot)$  of  $(\mathcal{G}; \circ, \cdot)$  is *normal*, denoted by  $\mathcal{H} \triangleleft \mathcal{G}$  if for  $\forall g \in \mathcal{G}$ ,

$$g \bullet \mathcal{H} = \mathcal{H} \bullet g,$$

where  $g \bullet \mathcal{H} = \{g \bullet h \mid h \in \mathcal{H} \text{ provided } g \bullet h \text{ existing}\}$  and  $\mathcal{H} \bullet g = \{h \bullet g \mid h \in \mathcal{H} \text{ provided } h \bullet g \text{ existing}\}$  for  $\forall \bullet \in \{\circ, \cdot\}$ . The next result is a generalization of isomorphism theorem of group

in [33].

**Theorem 2.4**([11]) *Let  $(\phi, \iota) : (\mathcal{G}_1; \{\circ_1, \cdot_1\}) \rightarrow (\mathcal{G}_2; \{\circ_2, \cdot_2\})$  be a homomorphism. Then*

$$G_1/\text{Ker}(\phi, \iota) \simeq \text{Im}(\phi, \iota).$$

Particularly, if  $(\mathcal{G}_2; \{\circ_2, \cdot_2\})$  is a group  $(\mathcal{A}; \circ)$ , we know the corollary following.

**Corollary 2.5** *Let  $(\phi, \iota) : (\mathcal{G}; \{\circ, \cdot\}) \rightarrow (\mathcal{A}; \circ)$  be an epimorphism. Then*

$$\mathcal{G}_1/\text{Ker}(\phi, \iota) \simeq (\mathcal{A}; \circ).$$

Similarly, a bigroup  $(\mathcal{G}; \circ, \cdot)$  is *distributive* if

$$a \cdot (b \circ c) = a \cdot b \circ a \cdot c$$

hold for all  $a, b, c \in \mathcal{G}$ . Then, we know the following result.

**Theorem 2.6**([11]) *Let  $(\mathcal{G}; \circ, \cdot)$  be a distributive bigroup of order  $\geq 2$  with  $\mathcal{G} = \mathcal{A}_1 \cup \mathcal{A}_2$  such that  $(\mathcal{A}_1; \circ)$  and  $(\mathcal{A}_2; \cdot)$  are groups. Then there must be  $\mathcal{A}_1 \neq \mathcal{A}_2$ . consequently, if  $(\mathcal{G}; \circ)$  it a non-trivial group, there are no operations  $\cdot \neq \circ$  on  $\mathcal{G}$  such that  $(\mathcal{G}; \circ, \cdot)$  is a distributive bigroup.*

## 2.2 $G^L$ -Systems

Definition 2.2 is easily generalized also to multigroups, i.e., consisting of  $m$  groups underlying a topological graph  $G^L$ , and similarly, define conceptions of homomorphism, submultigroup and normal submultigroup,  $\dots$  of a multigroup without any difficult.

For example, a normal submultigroup of  $(\tilde{\mathcal{G}}; \tilde{O})$  is such submutigroup  $(\tilde{\mathcal{H}}; \tilde{O})$  that holds

$$g \circ \tilde{\mathcal{H}} = \tilde{\mathcal{H}} \circ g$$

for  $\forall g \in \tilde{\mathcal{G}}, \forall \circ \in O$ , and generalize Theorem 2.3 to the following.

**Theorem 2.7**([16]) *Let  $(\phi, \iota) : (\tilde{\mathcal{G}}_1; \tilde{O}_1) \rightarrow (\tilde{\mathcal{G}}_2; \tilde{O}_2)$  be a homomorphism. Then*

$$\tilde{\mathcal{G}}_1/\text{Ker}(\phi, \iota) \simeq \text{Im}(\phi, \iota).$$

Particularly, for the transitive of multigroup action on a set  $\tilde{\Omega}$ , let  $\tilde{\mathcal{P}}$  be a permutation multigroup action on  $\tilde{\Omega}$  with  $\tilde{\mathcal{P}} = \bigcup_{i=1}^m \mathcal{P}_i, \tilde{\Omega} = \bigcup_{i=1}^m \Omega_i$  and for each integer  $i, 1 \leq i \leq m$ , the permutation group  $\mathcal{P}_i$  acts on  $\Omega_i$ , which is *globally  $k$ -transitive* for an integer  $k \geq 1$  if for any two  $k$ -tuples  $x_1, x_2, \dots, x_k \in \Omega_i$  and  $y_1, y_2, \dots, y_k \in \Omega_j$ , where  $1 \leq i, j \leq m$ , there are permutations  $\pi_1, \pi_2, \dots, \pi_n$  such that

$$x_1^{\pi_1 \pi_2 \dots \pi_n} = y_1, x_2^{\pi_1 \pi_2 \dots \pi_n} = y_2, \dots, x_k^{\pi_1 \pi_2 \dots \pi_n} = y_k$$

and abbreviate the globally 1-transitive to that *globally transitive* of a permutation multigroup. The following result characterizes transitive multigroup.

**Theorem 2.8**([17]) *Let  $\widetilde{\mathcal{P}}$  be a permutation multigroup action on  $\widetilde{\Omega}$  with*

$$\widetilde{\mathcal{P}} = \bigcup_{i=1}^m \mathcal{P}_i \quad \text{and} \quad \widetilde{\Omega} = \bigcup_{i=1}^m \Omega_i,$$

where, each permutation group  $\mathcal{P}_i$  transitively acts on  $\Omega_i$  for each integers  $1 \leq i \leq m$ . Then  $\widetilde{\mathcal{P}}$  is globally transitive on  $\widetilde{\Omega}$  if and only if the graph  $G^L[\widetilde{\Omega}]$  is connected.

Similarly, let  $\widetilde{R} = \bigcup_{i=1}^m R_i$  be a completed multisystem with a double operation set  $\mathcal{O}(\widetilde{R}) = \mathcal{O}_1 \cup \mathcal{O}_2$ , where  $\mathcal{O}_1 = \{ \cdot_i, 1 \leq i \leq m \}$ ,  $\mathcal{O}_2 = \{ +_i, 1 \leq i \leq m \}$ . If for any integers  $i, 1 \leq i \leq m$ ,  $(R_i; +_i, \cdot_i)$  is a ring, then  $\widetilde{R}$  is called a multiring, denoted by  $(\widetilde{R}; \mathcal{O}_1 \leftrightarrow \mathcal{O}_2)$  and  $(+_i, \cdot_i)$  a double operation for any integer  $i$ , which is *integral* if for  $\forall a, b \in \widetilde{R}$  and an integer  $i, 1 \leq i \leq m$ ,  $a \cdot_i b = b \cdot_i a, 1_{\cdot_i} \neq 0_{+_i}$  and  $a \cdot_i b = 0_{+_i}$  implies that  $a = 0_{+_i}$  or  $b = 0_{+_i}$ . Such a multiring  $(\widetilde{R}; \mathcal{O}_1 \leftrightarrow \mathcal{O}_2)$  is called a *skew multifield* or a *multifield* if each  $(R_i; +_i, \cdot_i)$  is a skew field or a field for integers  $1 \leq i \leq m$ . The next result is a generalization of finitely integral ring.

**Theorem 2.9**([16]) *A finitely integral multiring is a multifield.*

For multimodule, let  $\mathcal{O} = \{ +_i \mid 1 \leq i \leq m \}$ ,  $\mathcal{O}_1 = \{ \cdot_i \mid 1 \leq i \leq m \}$  and  $\mathcal{O}_2 = \{ \dot{+}_i \mid 1 \leq i \leq m \}$  be operation sets,  $(\mathcal{M}; \mathcal{O})$  a commutative multigroup with units  $0_{+_i}$  and  $(\mathcal{R}; \mathcal{O}_1 \leftrightarrow \mathcal{O}_2)$  a multiring with a unit 1. for  $\forall \cdot \in \mathcal{O}_1$ . A pair  $(\mathcal{M}; \mathcal{O})$  is said to be a *multimodule over*  $(\mathcal{R}; \mathcal{O}_1 \leftrightarrow \mathcal{O}_2)$  if for any integer  $i, 1 \leq i \leq m$ , a binary operation  $\times_i : \mathcal{R} \times \mathcal{M} \rightarrow \mathcal{M}$  is defined by  $a \times_i x$  for  $a \in \mathcal{R}, x \in \mathcal{M}$  such that the conditions following

- (1)  $a \times_i (x +_i y) = a \times_i x +_i a \times_i y$ ;
- (2)  $(a \dot{+}_i b) \times_i x = a \times_i x +_i b \times_i x$ ;
- (3)  $(a \cdot_i b) \times_i x = a \times_i (b \times_i x)$ ;
- (4)  $1_{\cdot_i} \times_i x = x$ .

hold for  $\forall a, b \in \mathcal{R}, \forall x, y \in \mathcal{M}$ , denoted by  $\mathbf{Mod}(\mathcal{M}(\mathcal{O}) : \mathcal{R}(\mathcal{O}_1 \leftrightarrow \mathcal{O}_2))$ . Then we know the following result for finitely multimodules.

**Theorem 2.10**([16]) *Let  $\mathbf{Mod}(\mathcal{M}(\mathcal{O}) : \mathcal{R}(\mathcal{O}_1 \leftrightarrow \mathcal{O}_2)) = \langle \widehat{S} | \mathcal{R} \rangle$  be a finitely generated multimodule with  $\widehat{S} = \{u_1, u_2, \dots, u_n\}$ . Then*

$$\mathbf{Mod}(\mathcal{M}(\mathcal{O}) : \mathcal{R}(\mathcal{O}_1 \leftrightarrow \mathcal{O}_2)) \cong \mathbf{Mod}(\mathcal{R}^{(n)} : \mathcal{R}(\mathcal{O}_1 \leftrightarrow \mathcal{O}_2)),$$

where  $\mathbf{Mod}(\mathcal{R}^{(n)} : \mathcal{R}(\mathcal{O}_1 \leftrightarrow \mathcal{O}_2))$  is a multimodule on  $\mathcal{R}^{(n)} = \{(x_1, x_2, \dots, x_n) \mid x_i \in \mathcal{R}, 1 \leq i \leq n\}$  with

$$(x_1, x_2, \dots, x_n) +_i (y_1, y_2, \dots, y_n) = (x_1 \dot{+}_i y_1, x_2 \dot{+}_i y_2, \dots, x_n \dot{+}_i y_n),$$

$$a \times_i (x_1, x_2, \dots, x_n) = (a \cdot_i x_1, a \cdot_i x_2, \dots, a \cdot_i x_n)$$

for  $\forall a \in \mathcal{R}$ , integers  $1 \leq i \leq m$ . Particularly, a finitely module over a commutative ring  $(\mathcal{R}; +, \cdot)$  generated by  $n$  elements is isomorphic to the module  $\mathcal{R}^n$  over  $(\mathcal{R}; +, \cdot)$ .

### §3. Geometrical Combinatorics

Classical geometry, such as those of Euclidean or non-Euclidean geometry, or projective geometry are not combinatorial. Whence, the CC conjecture produces combinatorial notions for their development further, for instance the topological space shown in Fig.5 following.

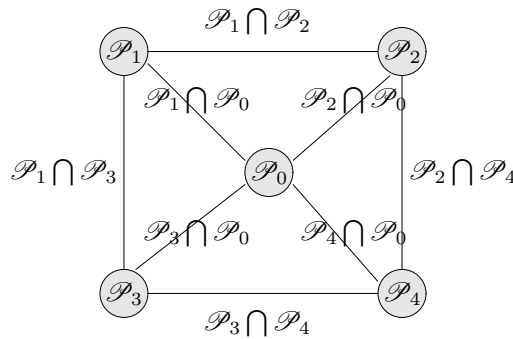

Fig.5

**Notion 3.1** For a geometrical space  $\mathcal{P}$ , determine its underlying topological structure  $G^L[\mathcal{A}, \mathcal{O}]$  on subspaces, for instance,  $n$ -manifolds and classify them by graph isomorphisms.

**Notion 3.2** For an integer  $m \geq 1$ , let  $\mathcal{P}_1, \mathcal{P}_2, \dots, \mathcal{P}_m$  all be geometrical spaces in Definition 1.2 and  $\tilde{\mathcal{P}}$  underlying  $G^L[\tilde{\mathcal{P}}]$  with  $\tilde{\mathcal{P}} = \bigcup_{i=1}^m \mathcal{P}_i$ , i.e., a geometrical multispace. Characterize  $\tilde{\mathcal{P}}$  and establish geometrical theory, i.e., combinatorial geometry on  $\tilde{\mathcal{P}}$ .

#### 3.1 Euclidean Spaces

Let  $\bar{\epsilon}_1 = (1, 0, \dots, 0)$ ,  $\bar{\epsilon}_2 = (0, 1, 0, \dots, 0)$ ,  $\dots$ ,  $\bar{\epsilon}_n = (0, \dots, 0, 1)$  be the normal basis of a Euclidean space  $\mathbb{R}^n$  in a general position, i.e., for two Euclidean spaces  $\mathbb{R}^{n_\mu}, \mathbb{R}^{n_\nu}$ ,  $\mathbb{R}^{n_\mu} \cap \mathbb{R}^{n_\nu} \neq \mathbb{R}^{\min\{n_\mu, n_\nu\}}$ . In this case, let  $\mathcal{X}_{v_\mu}$  be the set of orthogonal orientations in  $\mathbb{R}^{n_{v_\mu}}$ ,  $\mu \in \Lambda$ . Then  $\mathbb{R}^{n_\mu} \cap \mathbb{R}^{n_\nu} = \mathcal{X}_{v_\mu} \cap \mathcal{X}_{v_\nu}$ , which enables us to construct topological spaces by the combination.

For an index set  $\Lambda$ , a *combinatorial Euclidean space*  $\mathcal{E}_{G^L}(n_\nu; \nu \in \Lambda)$  underlying a connected graph  $G^L$  is a topological spaces consisting of Euclidean spaces  $\mathbb{R}^{n_\nu}$ ,  $\nu \in \Lambda$  such that

$$V(G^L) = \{ \mathbb{R}^{n_\nu} \mid \nu \in \Lambda \};$$

$$E(G^L) = \{ (\mathbb{R}^{n_\mu}, \mathbb{R}^{n_\nu}) \mid \mathbb{R}^{n_\mu} \cap \mathbb{R}^{n_\nu} \neq \emptyset, \mu, \nu \in \Lambda \} \text{ and labeling}$$

$$L : \mathbb{R}^{n_\nu} \rightarrow \mathbb{R}^{n_\nu} \text{ and } L : (\mathbb{R}^{n_\mu}, \mathbb{R}^{n_\nu}) \rightarrow \mathbb{R}^{n_\mu} \cap \mathbb{R}^{n_\nu}$$

for  $(\mathbb{R}^{n_\mu}, \mathbb{R}^{n_\nu}) \in E(G^L)$ ,  $\nu, \mu \in \Lambda$ .

Clearly, for any graph  $G$ , we are easily construct a combinatorial Euclidean space underlying  $G$ , which induces a problem following.



**Problem 3.3** Determine the dimension of a combinatorial Euclidean space consisting of  $m$  Euclidean spaces  $\mathbb{R}^{n_1}, \mathbb{R}^{n_2}, \dots, \mathbb{R}^{n_m}$ .

Generally, the combinatorial Euclidean spaces  $\mathcal{E}_{GL}(n_1, n_2, \dots, n_m)$  are not unique and to determine  $\dim \mathcal{E}_{GL}(n_1, n_2, \dots, n_m)$  converts to calculate the cardinality of  $|X_{n_1} \cup \dots \cup X_{n_m}|$ , where  $X_{n_i}$  is the set of orthogonal orientations in  $\mathbb{R}^{n_i}$  for integers  $1 \leq i \leq m$ , which can be determined by the inclusion-exclusion principle, particularly, the maximum dimension following.

**Theorem 3.4**([21])  $\dim \mathcal{E}_{GL}(n_1, \dots, n_m) \leq 1 - m + \sum_{i=1}^m n_i$  and with the equality holds if and only if  $\dim(\mathbb{R}^{n_i} \cap \mathbb{R}^{n_j}) = 1$  for  $\forall (\mathbb{R}^{n_i}, \mathbb{R}^{n_j}) \in E(G^L), 1 \leq i, j \leq m$ .

To determine the minimum  $\dim \mathcal{E}_{GL}(n_1, \dots, n_m)$  is still open. However, we know this number for  $G = K_m$  and  $n_i = r$  for integers  $1 \leq i \leq m$ , i.e.,  $\mathcal{E}_{K_m}(r)$  by following results.

**Theorem 3.5**([21]) For any integer  $r \geq 2$ , let  $\mathcal{E}_{K_m}(r)$  be a combinatorial Euclidean space of  $\underbrace{\mathbb{R}^r, \dots, \mathbb{R}^r}_m$ , and there exists an integer  $s, 0 \leq s \leq r - 1$  such that

$$\binom{r+s-1}{r} < m \leq \binom{r+s}{r}.$$

Then

$$\dim_{\min} \mathcal{E}_{K_m}(r) = r + s.$$

Particularly,

$$\dim_{\min} \mathcal{E}_{K_m}(3) = \begin{cases} 3, & \text{if } m = 1, \\ 4, & \text{if } 2 \leq m \leq 4, \\ 5, & \text{if } 5 \leq m \leq 10, \\ 2 + \lceil \sqrt{m} \rceil, & \text{if } m \geq 11. \end{cases}$$

### 3.2 Manifolds

An  $n$ -manifold is a second countable Hausdorff space of locally Euclidean  $n$ -space without boundary, which is in fact a combinatorial Euclidean space  $\mathcal{E}_{GL}(n)$ . Thus, we can further replace these Euclidean spaces by manifolds and to get topological spaces underlying a graph, such as those shown in Fig.6.

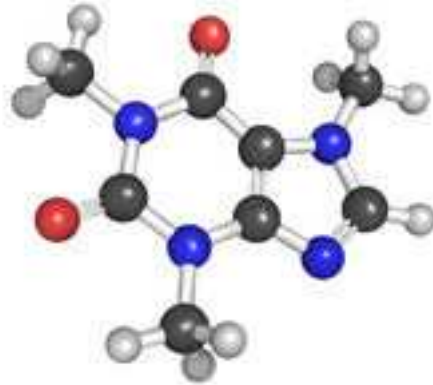

Fig.6

**Definition 3.6**([22]) Let  $\widetilde{M}$  be a topological space consisting of finite manifolds  $M_\mu$ ,  $\mu \in \Lambda$ . An inherent graph  $G^{in}[\widetilde{M}]$  of  $\widetilde{M}$  is such a graph with

$$V(G^{in}[\widetilde{M}]) = \{M_\mu, \mu \in \Lambda\};$$

$$E(G^{in}[\widetilde{M}]) = \{(M_\mu, M_\nu)_i, 1 \leq i \leq \kappa_{\mu\nu} + 1 | M_\mu \cap M_\nu \neq \emptyset, \mu, \nu \in \Lambda\},$$

where  $\kappa_{\mu\nu} + 1$  is the number of arcwise connected components in  $M_\mu \cap M_\nu$  for  $\mu, \nu \in \Lambda$ .

Notice that  $G^{in}[\widetilde{M}]$  is a multiple graph. If replace all multiple edges  $(M_\mu, M_\nu)_i$ ,  $1 \leq i \leq \kappa_{\mu\nu} + 1$  by  $(M_\mu, M_\nu)$ , such a graph is denoted by  $G[\widetilde{M}]$ , also an underlying graph of  $\widetilde{M}$ .

Clearly, if  $m = 1$ , then  $\widetilde{M}(n_i, i \in \Lambda)$  is nothing else but exactly an  $n_1$ -manifold by definition. Even so, Notion 3.1 enables us characterizing manifolds by graphs. The following result shows that every manifold is in fact homeomorphic to combinatorial Euclidean space.

**Theorem 3.7**([22]) Any locally compact  $n$ -manifold  $M$  with an atlas  $\mathcal{A} = \{(U_\lambda; \varphi_\lambda) | \lambda \in \Lambda\}$  is a combinatorial manifold  $\widetilde{M}$  homeomorphic to a combinatorial Euclidean space  $\mathcal{E}_{G^L}(n, \lambda \in \Lambda)$  with countable graphs  $G^{in}[M] \cong G$ .

Topologically, a Euclidean space  $\mathbb{R}^n$  is homeomorphic to an opened ball  $\mathbb{B}^n(R) = \{(x_1, x_2, \dots, x_n) | x_1^2 + x_2^2 + \dots + x_n^2 < R\}$ . Thus, we can view a combinatorial Euclidean space  $\mathcal{E}_G(n, \lambda \in \Lambda)$  as a graph with vertices and edges replaced by ball  $\mathbb{B}^n(R)$  in space, such as those shown in Fig.6, a 3-dimensional graph.

**Definition 3.8** An  $n$ -dimensional graph  $\widetilde{M}^n[G]$  is a combinatorial ball space  $\widetilde{B}$  of  $B^n$ ,  $\mu \in \Lambda$  underlying a combinatorial structure  $G$  such that

- (1)  $V(G)$  is discrete consisting of  $B^n$ , i.e.,  $\forall v \in V(G)$  is an open ball  $B_v^n$ ;
- (2)  $\widetilde{M}^n[G] \setminus V(\widetilde{M}^n[G])$  is a disjoint union of open subsets  $e_1, e_2, \dots, e_m$ , each of which is homeomorphic to an open ball  $B^n$ ;

(3) the boundary  $\bar{e}_i - e_i$  of  $e_i$  consists of one or two  $B^n$  and each pair  $(\bar{e}_i, e_i)$  is homeomorphic to the pair  $(\bar{B}^n, B^n)$ ;

(4) a subset  $A \subset \widetilde{M}^n[G]$  is open if and only if  $A \cap \bar{e}_i$  is open for  $1 \leq i \leq m$ .

Particularly, a topological graph  $\mathcal{T}[G]$  of a graph  $G$  embedded in a topological space  $\mathcal{P}$  is 1-dimensional graph.

According to Theorem 3.7, an  $n$ -manifold is homeomorphic to a combinatorial Euclidean space, i.e.,  $n$ -dimensional graph. This enables us knowing a result following on manifolds.

**Theorem 3.9**([22]) *Let  $\mathcal{A}[M] = \{ (U_\lambda; \varphi_\lambda) \mid \lambda \in \Lambda \}$  be a atlas of a locally compact  $n$ -manifold  $M$ . Then the labeled graph  $G_{|\Lambda|}^L$  of  $M$  is a topological invariant on  $|\Lambda|$ , i.e., if  $H_{|\Lambda|}^{L_1}$  and  $G_{|\Lambda|}^{L_2}$  are two labeled  $n$ -dimensional graphs of  $M$ , then there exists a self-homeomorphism  $h : M \rightarrow M$  such that  $h : H_{|\Lambda|}^{L_1} \rightarrow G_{|\Lambda|}^{L_2}$  naturally induces an isomorphism of graph.*

Theorem 3.9 enables us listing manifolds by two parameters, the dimensions and inherited graph. For example, let  $|\Lambda| = 2$  and then  $\mathcal{A}_{min}[M] = \{(U_1; \varphi_1), (U_2; \varphi_2)\}$ , i.e.,  $M$  is double covered underlying a graphs  $D_{0, \kappa_{12}+1, 0}^L$  shown in Fig.7,

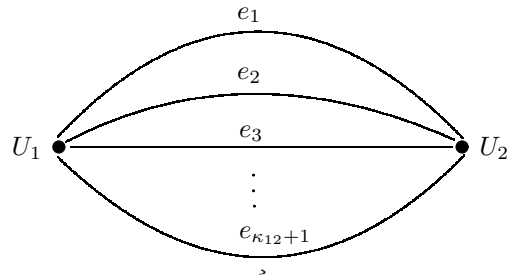

**Fig.7**

For example, let  $U_1 = \mathbb{R}^2$ ,  $\varphi_1 = z$ ,  $U_2 = (\mathbb{R}^2 \setminus \{(0, 0)\}) \cup \{\infty\}$ ,  $\varphi_2 = 1/z$  and  $\kappa_{12} = 0$ . Then the 2-manifold is nothing else but the Riemannian sphere.

The  $G^L$ -structure on combinatorial manifold  $\widetilde{M}$  can be also applied for characterizing a few topological invariants, such as those fundamental groups, for instance the conclusion following.

**Theorem 3.10**([23]) *For  $\forall (M_1, M_2) \in E(G^L[\widetilde{M}])$ , if  $M_1 \cap M_2$  is simply connected, then*

$$\pi_1(\widetilde{M}) \cong \left( \bigotimes_{M \in V(G[\widetilde{M}])} \pi_1(M) \right) \otimes \pi_1(G^{in}[\widetilde{M}]).$$

Particularly, for a compact  $n$ -manifold  $M$  with charts  $\{(U_\lambda, \varphi_\lambda) \mid \varphi_\lambda : U_\lambda \rightarrow \mathbf{R}^n, \lambda \in \Lambda\}$ , if  $U_\mu \cap U_\nu$  is simply connected for  $\forall \mu, \nu \in \Lambda$ , then

$$\pi_1(M) \cong \pi_1(G^{in}[M]).$$

### 3.3 Algebraic Geometry

The topological group, particularly, Lie group is a typical example of  $K^L$ -systems that of algebra with geometry. Generally, let

$$AX = (b_1, b_2, \dots, b_m)^T \tag{LEq}$$

be a linear equation system with

$$A = \begin{bmatrix} a_{11} & a_{12} & \cdots & a_{1n} \\ a_{21} & a_{22} & \cdots & a_{2n} \\ \cdots & \cdots & \cdots & \cdots \\ a_{m1} & a_{m2} & \cdots & a_{mn} \end{bmatrix} \quad \text{and} \quad X = \begin{bmatrix} x_1 \\ x_2 \\ \cdots \\ x_n \end{bmatrix}$$

for integers  $m, n \geq 1$ , and all equations in (LEq) are non-trivial, i.e., there are no numbers  $\lambda$  such that  $(a_{i1}, a_{i2}, \dots, a_{in}, b_i) = \lambda(a_{j1}, a_{j2}, \dots, a_{jn}, b_j)$  for any integers  $1 \leq i, j \leq m$ .

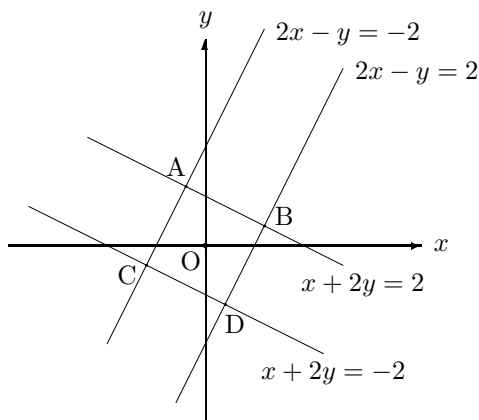

Fig.8

It should be noted that the geometry of a linear equation in  $n$  variables is a plane in  $\mathbb{R}^n$ . Whence, a linear system (LEq) is non-solvable or not dependent on their intersection is empty or not. For example, the linear system shown in Fig.8 is non-solvable because their intersection is empty.

**Definition 3.11** For any integers  $1 \leq i, j \leq m, i \neq j$ , the linear equations

$$\begin{aligned} a_{i1}x_1 + a_{i2}x_2 + \cdots + a_{in}x_n &= b_i, \\ a_{j1}x_1 + a_{j2}x_2 + \cdots + a_{jn}x_n &= b_j \end{aligned}$$

are called parallel if there no solution  $x_1, x_2, \dots, x_n$  hold both with the 2 equations.

Define a graph  $G^L[LEq]$  on linear system (LEq) following:

$$V(G^L[LEq]) = \{ \text{the solution space } S_i \text{ of } i\text{th equation} \mid 1 \leq i \leq m \},$$

$E(G^L[Eq]) = \{ (S_i, S_j) \mid S_i \cap S_j \neq \emptyset, 1 \leq i, j \leq m \}$  and with labels

$$L : S_i \rightarrow S_i \text{ and } L : (S_i, S_j) \rightarrow S_i \cap S_j$$

for  $\forall S_i \in V(G^L[LEq]), (S_i, S_j) \in E(G^L[LEq])$ . For example, the system of equations shown in Fig.8 is

$$\begin{cases} x + 2y = 2 \\ x + 2y = -2 \\ 2x - y = -2 \\ 2x - y = 2 \end{cases}$$

and  $C_4^L$  is its underlying graph  $G^L[LEq]$  shown in Fig.9.

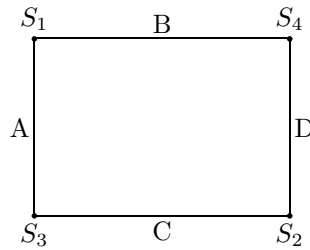

**Fig.9**

Let  $L_i$  be the  $i$ th linear equation. By definition we divide these equations  $L_i, 1 \leq i \leq m$  into *parallel families*

$$\mathcal{C}_1, \mathcal{C}_2, \dots, \mathcal{C}_s$$

by the property that all equations in a family  $\mathcal{C}_i$  are parallel and there are no other equations parallel to lines in  $\mathcal{C}_i$  for integers  $1 \leq i \leq s$ . Denoted by  $|\mathcal{C}_i| = n_i, 1 \leq i \leq s$ . Then, we can characterize  $G^L[LEq]$  following.

**Theorem 3.12**([24]) *Let  $(LEq)$  be a linear equation system for integers  $m, n \geq 1$ . Then*

$$G^L[LEq] \simeq K_{n_1, n_2, \dots, n_s}^L$$

with  $n_1 + n_2 + \dots + n_s = m$ , where  $\mathcal{C}_i$  is the parallel family with  $n_i = |\mathcal{C}_i|$  for integers  $1 \leq i \leq s$  in  $(LEq)$  and  $(LEq)$  is non-solvable if  $s \geq 2$ .

Notice that this result is not sufficient, i.e., even if  $G^L[LEq] \simeq K_{n_1, n_2, \dots, n_s}^L$ , we can not claim that  $(LEq)$  is solvable or not. However, if  $n = 2$ , we can get a necessary and sufficient condition on non-solvable linear equations.

Let  $H$  be a planar graph with each edge a straight segment on  $\mathbb{R}^2$ . Its *c-line graph*  $L_C(H)$  is defined by

$$\begin{aligned} V(L_C(H)) &= \{\text{straight lines } L = e_1 e_2 \cdots e_l, l \geq 1 \text{ in } H\}; \\ E(L_C(H)) &= \{(L_1, L_2) \mid \text{if } e_i^1 \text{ and } e_j^2 \text{ are adjacent in } H \text{ for } L_1 = e_1^1 e_2^1 \cdots e_l^1, L_2 = e_1^2 e_2^2 \cdots e_s^2, l, s \geq 1\}. \end{aligned}$$

**Theorem 3.13**([24]) *A linear equation system (LEq2) is non-solvable if and only if  $G^L[LEq2] \simeq L_C(H)$ , where  $H$  is a planar graph of order  $|H| \geq 2$  on  $\mathbb{R}^2$  with each edge a straight segment*

Similarly, let

$$P_1(\bar{x}), P_2(\bar{x}), \dots, P_m(\bar{x}) \tag{ES_m^{n+1}}$$

be  $m$  homogeneous polynomials in  $n + 1$  variables with coefficients in  $\mathbb{C}$  and each equation  $P_i(\bar{x}) = 0$  determine a hypersurface  $M_i$ ,  $1 \leq i \leq m$  in  $\mathbb{R}^{n+1}$ , particularly, a curve  $C_i$  if  $n = 2$ . We introduce the parallel property following.

**Definition 3.14** *Let  $P(\bar{x}), Q(\bar{x})$  be two complex homogeneous polynomials of degree  $d$  in  $n + 1$  variables and  $I(P, Q)$  the set of intersection points of  $P(\bar{x})$  with  $Q(\bar{x})$ . They are said to be parallel, denoted by  $P \parallel Q$  if  $d > 1$  and there are constants  $a, b, \dots, c$  (not all zero) such that for  $\forall \bar{x} \in I(P, Q)$ ,  $ax_1 + bx_2 + \dots + cx_{n+1} = 0$ , i.e., all intersections of  $P(\bar{x})$  with  $Q(\bar{x})$  appear at a hyperplane on  $\mathbb{P}^n \mathbb{C}$ , or  $d = 1$  with all intersections at the infinite  $x_{n+1} = 0$ . Otherwise,  $P(\bar{x})$  are not parallel to  $Q(\bar{x})$ , denoted by  $P \not\parallel Q$ .*

Define a topological graph  $G^L[ES_m^{n+1}]$  in  $\mathbb{C}^{n+1}$  by

$$\begin{aligned} V(G^L[ES_m^{n+1}]) &= \{P_1(\bar{x}), P_2(\bar{x}), \dots, P_m(\bar{x})\}; \\ E(G^L[ES_m^{n+1}]) &= \{(P_i(\bar{x}), P_j(\bar{x})) \mid P_i \not\parallel P_j, 1 \leq i, j \leq m\} \end{aligned}$$

with a labeling

$$L : P_i(\bar{x}) \rightarrow P_i(\bar{x}), \quad (P_i(\bar{x}), P_j(\bar{x})) \rightarrow I(P_i, P_j),$$

where  $1 \leq i \neq j \leq m$ , and the topological graph of  $G^L[ES_m^{n+1}]$  without labels is denoted by  $G[ES_m^{n+1}]$ . The following result generalizes Theorem 3.12 to homogeneous polynomials.

**Theorem 3.15**([26]) *Let  $n \geq 2$  be an integer. For a system  $(ES_m^{n+1})$  of homogeneous polynomials with a parallel maximal classification  $\mathcal{C}_1, \mathcal{C}_2, \dots, \mathcal{C}_l$ ,*

$$G[ES_m^{n+1}] \leq K(\mathcal{C}_1, \mathcal{C}_2, \dots, \mathcal{C}_l)$$

*and with equality holds if and only if  $P_i \parallel P_j$  and  $P_s \not\parallel P_i$  implies that  $P_s \not\parallel P_j$ , where  $K(\mathcal{C}_1, \mathcal{C}_2, \dots, \mathcal{C}_l)$  denotes a complete  $l$ -partite graphs*

*Conversely, for any subgraph  $G \leq K(\mathcal{C}_1, \mathcal{C}_2, \dots, \mathcal{C}_l)$ , there are systems  $(ES_m^{n+1})$  of homogeneous polynomials with a parallel maximal classification  $\mathcal{C}_1, \mathcal{C}_2, \dots, \mathcal{C}_l$  such that*

$$G \simeq G[ES_m^{n+1}].$$

Particularly, if  $n = 2$ , i.e., an  $(ES_m^3)$  system, we get the condition following.

**Theorem 3.16**([26]) *Let  $G^L$  be a topological graph labeled with  $I(e)$  for  $\forall e \in E(G^L)$ . Then there is a system  $(ES_m^3)$  of homogeneous polynomials such that  $G^L[ES_m^3] \simeq G^L$  if and only if*

there are homogeneous polynomials  $P_{v_i}(x, y, z), 1 \leq i \leq \rho(v)$  for  $\forall v \in V(G^L)$  such that

$$I(e) = I \left( \prod_{i=1}^{\rho(u)} P_{u_i}, \prod_{i=1}^{\rho(v)} P_{v_i} \right)$$

for  $e = (u, v) \in E(G^L)$ , where  $\rho(v)$  denotes the valency of vertex  $v$  in  $G^L$ .

These  $G^L$ -system of homogeneous polynomials enables us to get combinatorial manifolds, for instance, the following result appeared in [26].

**Theorem 3.17** *Let  $(ES_m^{n+1})$  be a  $G^L$ -system consisting of homogeneous polynomials  $P_1(\bar{x}), P_2(\bar{x}), \dots, P_m(\bar{x})$  in  $n + 1$  variables with respectively hypersurfaces  $S_1, S_2, \dots, S_m$ . Then there is a combinatorial manifold  $\tilde{M}$  in  $\mathbb{C}^{n+1}$  such that  $\pi : \tilde{M} \rightarrow \tilde{S}$  is 1 - 1 with  $G^L[\tilde{M}] \simeq G^L[\tilde{S}]$ , where,  $\tilde{S} = \bigcup_{i=1}^m S_i$ .*

Particularly, if  $n = 2$ , we can further determine the genus of surface  $g(\tilde{S})$  by closed formula as follows.

**Theorem 3.18**([26]) *Let  $C_1, C_2, \dots, C_m$  be complex curves determined by homogeneous polynomials  $P_1(x, y, z), P_2(x, y, z), \dots, P_m(x, y, z)$  without common component, and let*

$$R_{P_i, P_j} = \prod_{k=1}^{\deg(P_i)\deg(P_j)} (c_k^{ij}z - b_k^{ij}y)^{e_k^{ij}}, \quad \omega_{i,j} = \sum_{k=1}^{\deg(P_i)\deg(P_j)} \sum_{e_k^{ij} \neq 0} 1$$

be the resultant of  $P_i(x, y, z), P_j(x, y, z)$  for  $1 \leq i \neq j \leq m$ . Then there is an orientable surface  $\tilde{S}$  in  $\mathbb{R}^3$  of genus

$$g(\tilde{S}) = \beta(G\langle\tilde{C}\rangle) + \sum_{i=1}^m \left( \frac{(\deg(P_i) - 1)(\deg(P_i) - 2)}{2} - \sum_{p^i \in \text{Sing}(C_i)} \delta(p^i) \right) + \sum_{1 \leq i \neq j \leq m} (\omega_{i,j} - 1) + \sum_{i \geq 3} (-1)^i \sum_{C_{k_1} \cap \dots \cap C_{k_i} \neq \emptyset} [c(C_{k_1} \cap \dots \cap C_{k_i}) - 1]$$

with a homeomorphism  $\varphi : \tilde{S} \rightarrow \tilde{C} = \bigcup_{i=1}^m C_i$ . Furthermore, if  $C_1, C_2, \dots, C_m$  are non-singular, then

$$g(\tilde{S}) = \beta(G\langle\tilde{C}\rangle) + \sum_{i=1}^m \frac{(\deg(P_i) - 1)(\deg(P_i) - 2)}{2} + \sum_{1 \leq i \neq j \leq m} (\omega_{i,j} - 1) + \sum_{i \geq 3} (-1)^i \sum_{C_{k_1} \cap \dots \cap C_{k_i} \neq \emptyset} [c(C_{k_1} \cap \dots \cap C_{k_i}) - 1],$$

where

$$\delta(p^i) = \frac{1}{2} \left( I_{p^i} \left( P_i, \frac{\partial P_i}{\partial y} \right) - \nu_\phi(p^i) + |\pi^{-1}(p^i)| \right)$$

is a positive integer with a ramification index  $\nu_\phi(p^i)$  for  $p^i \in \text{Sing}(C_i)$ ,  $1 \leq i \leq m$ .

Theorem 3.17 enables us to find interesting results in projective geometry, for instance the following result.

**Corollary 3.19** *Let  $C_1, C_2, \dots, C_m$  be complex non-singular curves determined by homogeneous polynomials  $P_1(x, y, z), P_2(x, y, z), \dots, P_m(x, y, z)$  without common component and  $C_i \cap C_j = \bigcap_{i=1}^m C_i$  with  $\left| \bigcap_{i=1}^m C_i \right| = \kappa > 0$  for integers  $1 \leq i \neq j \leq m$ . Then the genus of normalization  $\tilde{S}$  of curves  $C_1, C_2, \dots, C_m$  is*

$$g(\tilde{S}) = g(\tilde{S}) = (\kappa - 1)(m - 1) + \sum_{i=1}^m \frac{(\deg(P_i) - 1)(\deg(P_i) - 2)}{2}.$$

Particularly, if  $C_1, C_2, \dots, C_m$  are distinct lines in  $\mathbb{P}^2\mathbf{C}$  with respective normalizations of spheres  $S_1, S_2, \dots, S_m$ . Then there is a normalization of surface  $\tilde{S}$  of  $C_1, C_2, \dots, C_m$  with genus  $\beta(G \langle \tilde{L} \rangle)$ . Furthermore, if  $G \langle \tilde{L} \rangle$  is a tree, then  $\tilde{S}$  is homeomorphic to a sphere.

### 3.4 Combinatorial Geometry

Furthermore, we can establish combinatorial geometry by Notion 3.2. For example, we have 3 classical geometries, i.e., *Euclidean, hyperbolic geometry* and *Riemannian geometries* for describing behaviors of objects in spaces with different axioms following:

#### Euclid Geometry:

- (A1) *There is a straight line between any two points.*
- (A2) *A finite straight line can produce a infinite straight line continuously.*
- (A3) *Any point and a distance can describe a circle.*
- (A4) *All right angles are equal to one another.*
- (A5) *If a straight line falling on two straight lines make the interior angles on the same side less than two right angles, then the two straight lines, if produced indefinitely, meet on that side on which are the angles less than the two right angles.*

#### Hyperbolic Geometry:

Axioms (A1) – (A4) and the axiom (L5) following:

- (L5) *there are infinitely many lines parallel to a given line passing through an exterior point.*

#### Riemannian Geometry:

Axioms (A1) – (A4) and the axiom (R5) following:

*there is no parallel to a given line passing through an exterior point.*

Then whether there is a geometry established by combining the 3 geometries, i.e., partially Euclidean and partially hyperbolic or Riemannian. Today, we have know such theory really exists, called *Smarandache geometry* defined following.



**Definition 3.20**([12]) *An axiom is said to be Smarandachely denied if the axiom behaves in at least two different ways within the same space, i.e., validated and invalidated, or only invalidated but in multiple distinct ways.*

*A Smarandache geometry is a geometry which has at least one Smarandachely denied axiom (1969).*

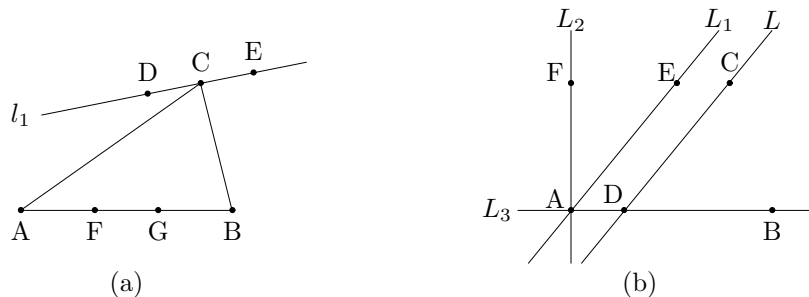

**Fig.10**

For example, let us consider a Euclidean plane  $\mathbb{R}^2$  and three non-collinear points  $A, B$  and  $C$  shown in Fig.10. Define  $s$ -points as all usual Euclidean points on  $\mathbb{R}^2$  and  $s$ -lines any Euclidean line that passes through one and only one of points  $A, B$  and  $C$ . Then such a geometry is a Smarandache geometry by the following observations.

**Observation 1.** The axiom (E1) that through any two distinct points there exist one line passing through them is now replaced by: *one s-line and no s-line*. Notice that through any two distinct  $s$ -points  $D, E$  collinear with one of  $A, B$  and  $C$ , there is one  $s$ -line passing through them and through any two distinct  $s$ -points  $F, G$  lying on  $AB$  or non-collinear with one of  $A, B$  and  $C$ , there is no  $s$ -line passing through them such as those shown in Fig.10(a).

**Observation 2.** The axiom (E5) that through a point exterior to a given line there is only one parallel passing through it is now replaced by two statements: *one parallel and no parallel*. Let  $L$  be an  $s$ -line passes through  $C$  and  $D$  on  $L$ , and  $AE$  is parallel to  $CD$  in the Euclidean sense. Then there is one and only one line passing through  $E$  which is parallel to  $L$ , but passing a point not on  $AE$ , for instance, point  $F$  there are no lines parallel to  $L$  such as those shown in Fig.10(b).

Generally, we can construct a Smarandache geometry on smoothly combinatorial manifolds  $\widetilde{M}$ , i.e., combinatorial geometry because it is homeomorphic to combinatorial Euclidean space  $\mathcal{E}_{GL}(n_1, n_2, \dots, n_m)$  by Definition 3.6 and Theorem 3.7. Such a theory is founded on the results for basis of tangent and cotangent vectors following.

**Theorem 3.21**([15]) *For any point  $p \in \widetilde{M}(n_1, n_2, \dots, n_m)$  with a local chart  $(U_p; [\varphi_p])$ , the dimension of  $T_p\widetilde{M}(n_1, n_2, \dots, n_m)$  is*

$$\dim T_p\widetilde{M}(n_1, n_2, \dots, n_m) = \widehat{s}(p) + \sum_{i=1}^{s(p)} (n_i - \widehat{s}(p))$$

with a basis matrix  $\left[ \frac{\partial}{\partial \bar{x}} \right]_{s(p) \times n_{s(p)}} =$

$$\left[ \begin{array}{cccccc} \frac{1}{s(p)} \frac{\partial}{\partial x^{11}} & \cdots & \frac{1}{s(p)} \frac{\partial}{\partial x^{1\widehat{s}(p)}} & \frac{\partial}{\partial x^{1(\widehat{s}(p)+1)}} & \cdots & \frac{\partial}{\partial x^{1n_1}} & \cdots & 0 \\ \frac{1}{s(p)} \frac{\partial}{\partial x^{21}} & \cdots & \frac{1}{s(p)} \frac{\partial}{\partial x^{2\widehat{s}(p)}} & \frac{\partial}{\partial x^{2(\widehat{s}(p)+1)}} & \cdots & \frac{\partial}{\partial x^{2n_2}} & \cdots & 0 \\ \cdots & \cdots & \cdots & \cdots & \cdots & \cdots & \cdots & \cdots \\ \frac{1}{s(p)} \frac{\partial}{\partial x^{s(p)1}} & \cdots & \frac{1}{s(p)} \frac{\partial}{\partial x^{s(p)\widehat{s}(p)}} & \frac{\partial}{\partial x^{s(p)(\widehat{s}(p)+1)}} & \cdots & \cdots & \frac{\partial}{\partial x^{s(p)(n_{s(p)}-1)}} & \frac{\partial}{\partial x^{s(p)n_{s(p)}}} \end{array} \right]$$

where  $x^{il} = x^{jl}$  for  $1 \leq i, j \leq s(p), 1 \leq l \leq \widehat{s}(p)$ , namely there is a smoothly functional matrix  $[v_{ij}]_{s(p) \times n_{s(p)}}$  such that for any tangent vector  $\bar{v}$  at a point  $p$  of  $\widetilde{M}(n_1, n_2, \dots, n_m)$ ,

$$\bar{v} = \left\langle [v_{ij}]_{s(p) \times n_{s(p)}}, \left[ \frac{\partial}{\partial \bar{x}} \right]_{s(p) \times n_{s(p)}} \right\rangle,$$

where  $\langle [a_{ij}]_{k \times l}, [b_{ts}]_{k \times l} \rangle = \sum_{i=1}^k \sum_{j=1}^l a_{ij} b_{ij}$ , the inner product on matrixes.

**Theorem 3.22**([15]) For  $\forall p \in (\widetilde{M}(n_1, n_2, \dots, n_m); \widetilde{\mathcal{A}})$  with a local chart  $(U_p; [\varphi_p])$ , the dimension of  $T_p^* \widetilde{M}(n_1, n_2, \dots, n_m)$  is

$$\dim T_p^* \widetilde{M}(n_1, n_2, \dots, n_m) = \widehat{s}(p) + \sum_{i=1}^{s(p)} (n_i - \widehat{s}(p))$$

with a basis matrix  $[d\bar{x}]_{s(p) \times n_{s(p)}} =$

$$\left[ \begin{array}{cccccc} \frac{dx^{11}}{s(p)} & \cdots & \frac{dx^{1\widehat{s}(p)}}{s(p)} & dx^{1(\widehat{s}(p)+1)} & \cdots & dx^{1n_1} & \cdots & 0 \\ \frac{dx^{21}}{s(p)} & \cdots & \frac{dx^{2\widehat{s}(p)}}{s(p)} & dx^{2(\widehat{s}(p)+1)} & \cdots & dx^{2n_2} & \cdots & 0 \\ \cdots & \cdots & \cdots & \cdots & \cdots & \cdots & \cdots & \cdots \\ \frac{dx^{s(p)1}}{s(p)} & \cdots & \frac{dx^{s(p)\widehat{s}(p)}}{s(p)} & dx^{s(p)(\widehat{s}(p)+1)} & \cdots & \cdots & dx^{s(p)n_{s(p)}-1} & dx^{s(p)n_{s(p)}} \end{array} \right]$$

where  $x^{il} = x^{jl}$  for  $1 \leq i, j \leq s(p), 1 \leq l \leq \widehat{s}(p)$ , namely for any co-tangent vector  $d$  at a point  $p$  of  $\widetilde{M}(n_1, n_2, \dots, n_m)$ , there is a smoothly functional matrix  $[u_{ij}]_{s(p) \times s(p)}$  such that,

$$d = \left\langle [u_{ij}]_{s(p) \times n_{s(p)}}, [d\bar{x}]_{s(p) \times n_{s(p)}} \right\rangle.$$

Then we can establish tensor theory with connections on smoothly combinatorial manifolds ([15]). For example, we can establish the curvatures on smoothly combinatorial manifolds, and get the curvature  $\widetilde{R}$  formula following.

**Theorem 3.23**([18]) Let  $\widetilde{M}$  be a finite combinatorial manifold,  $\widetilde{R} : \mathcal{X}(\widetilde{M}) \times \mathcal{X}(\widetilde{M}) \times \mathcal{X}(\widetilde{M}) \times \mathcal{X}(\widetilde{M}) \rightarrow C^\infty(\widetilde{M})$  a curvature on  $\widetilde{M}$ . Then for  $\forall p \in \widetilde{M}$  with a local chart  $(U_p; [\varphi_p])$ ,

$$\widetilde{R} = \widetilde{R}_{(\sigma\varsigma)(\eta\theta)(\mu\nu)(\kappa\lambda)} dx^{\sigma\varsigma} \otimes dx^{\eta\theta} \otimes dx^{\mu\nu} \otimes dx^{\kappa\lambda},$$

where

$$\begin{aligned} \tilde{R}_{(\sigma\varsigma)(\eta\theta)(\mu\nu)(\kappa\lambda)} &= \frac{1}{2} \left( \frac{\partial^2 g_{(\mu\nu)(\sigma\varsigma)}}{\partial x^{\kappa\lambda} \partial x^{\eta\theta}} + \frac{\partial^2 g_{(\kappa\lambda)(\eta\theta)}}{\partial x^{\mu\nu} \partial x^{\sigma\varsigma}} - \frac{\partial^2 g_{(\mu\nu)(\eta\theta)}}{\partial x^{\kappa\lambda} \partial x^{\sigma\varsigma}} - \frac{\partial^2 g_{(\kappa\lambda)(\sigma\varsigma)}}{\partial x^{\mu\nu} \partial x^{\eta\theta}} \right) \\ &+ \Gamma_{(\mu\nu)(\sigma\varsigma)}^{\vartheta\iota} \Gamma_{(\kappa\lambda)(\eta\theta)}^{\xi\omicron} g_{(\xi\omicron)(\vartheta\iota)} - \Gamma_{(\mu\nu)(\eta\theta)}^{\xi\omicron} \Gamma_{(\kappa\lambda)(\sigma\varsigma)\vartheta\iota} g_{(\xi\omicron)(\vartheta\iota)}, \end{aligned}$$

and  $g_{(\mu\nu)(\kappa\lambda)} = g(\frac{\partial}{\partial x^{\mu\nu}}, \frac{\partial}{\partial x^{\kappa\lambda}})$ .

This enables us to characterize the combination of classical fields, such as the Einstein's gravitational fields and other fields on combinatorial spacetimes and hold their behaviors ( See [19]-[20] for details).

### §4. Differential Equation's Combinatorics

Let

$$(Eq_m) \left\{ \begin{array}{l} f_1(x_1, x_2, \dots, x_{n+1}) = 0 \\ f_2(x_1, x_2, \dots, x_{n+1}) = 0 \\ \dots\dots\dots\dots\dots\dots\dots\dots\dots \\ f_m(x_1, x_2, \dots, x_{n+1}) = 0 \end{array} \right.$$

be a system of equations. It should be noted that the classical theory on equations is not combinatorics. However, the solutions of an equation usually form a manifold in the view of geometry. Thus, the CC conjecture bring us combinatorial notions for developing equation theory similar to that of geometry further.

**Notion 4.1** For a system  $(Eq_m)$  of equations, solvable or non-solvable, determine its underlying topological structure  $G^L[Eq_m]$  on each solution manifold and classify them by graph isomorphisms and transformations.

**Notion 4.2** For an integer  $m \geq 1$ , let  $\mathcal{D}_1, \mathcal{D}_2, \dots, \mathcal{D}_m$  be the solution manifolds of an equation system  $(Eq_m)$  in Definition 1.2 and  $\tilde{\mathcal{D}}$  underlying  $G^L[\tilde{\mathcal{D}}]$  with  $\tilde{\mathcal{D}} = \bigcup_{i=1}^m \mathcal{D}_i$ , i.e., a combinatorial solution manifold. Characterize the system  $(Eq_m)$  and establish an equation theory, i.e., equation's combinatorics on  $(Eq_m)$ .

Geometrically, let

$$S_{f_i} = \{(x_1, x_2, \dots, x_{n+1}) | f_i(x_1, x_2, \dots, x_{n+1}) = 0\} \subset \mathbb{R}^{n+1}$$

the solution-manifold in  $\mathbb{R}^{n+1}$  for integers  $1 \leq i \leq m$ , where  $f_i$  is a function hold with conditions of the implicit function theorem for  $1 \leq i \leq m$ . Then we are easily finding criterions on the solubility of system  $(ES_m)$ , i.e., it is solvable or not dependent on

$$\bigcap_{i=1}^m S_{f_i} \neq \emptyset \text{ or } = \emptyset.$$

Whence, if the intersection is empty, i.e.,  $(ES_m)$  is non-solvable, there are no meanings in classical theory on equations, but it is important for hold the global behaviors of a complex thing. For such an objective, Notions 4.1 and 4.2 are helpful.

Let us begin at a linear differential equations system such as those of

$$\dot{X} = A_1X, \dots, \dot{X} = A_kX, \dots, \dot{X} = A_mX \tag{LDES_m^1}$$

or

$$\begin{cases} x^{(n)} + a_{11}^{[0]}x^{(n-1)} + \dots + a_{1n}^{[0]}x = 0 \\ x^{(n)} + a_{21}^{[0]}x^{(n-1)} + \dots + a_{2n}^{[0]}x = 0 \\ \dots\dots\dots \\ x^{(n)} + a_{m1}^{[0]}x^{(n-1)} + \dots + a_{mn}^{[0]}x = 0 \end{cases} \tag{LDE_m^n}$$

with

$$A_k = \begin{bmatrix} a_{11}^{[k]} & a_{12}^{[k]} & \dots & a_{1n}^{[k]} \\ a_{21}^{[k]} & a_{22}^{[k]} & \dots & a_{2n}^{[k]} \\ \dots & \dots & \dots & \dots \\ a_{n1}^{[k]} & a_{n2}^{[k]} & \dots & a_{nn}^{[k]} \end{bmatrix} \quad \text{and} \quad X = \begin{bmatrix} x_1(t) \\ x_2(t) \\ \dots \\ x_n(t) \end{bmatrix}$$

where each  $a_{ij}^{[k]}$  is a real number for integers  $0 \leq k \leq m, 1 \leq i, j \leq n$ .

For example, let  $(LDE_6^2)$  be the following linear homogeneous differential equation system

$$\begin{cases} \ddot{x} + 3\dot{x} + 2x = 0 & (1) \\ \ddot{x} + 5\dot{x} + 6x = 0 & (2) \\ \ddot{x} + 7\dot{x} + 12x = 0 & (3) \\ \ddot{x} + 9\dot{x} + 20x = 0 & (4) \\ \ddot{x} + 11\dot{x} + 30x = 0 & (5) \\ \ddot{x} + 7\dot{x} + 6x = 0 & (6) \end{cases}$$

Certainly, it is non-solvable. However, we can easily solve equations (1)-(6) one by one and get their solution spaces as follows:

$$\begin{aligned} S_1 &= \langle e^{-t}, e^{-2t} \rangle = \{C_1e^{-t} + C_2e^{-2t} | C_1, C_2 \in \mathbb{R}\} = \{x | \ddot{x} + 3\dot{x} + 2x = 0\} \\ S_2 &= \langle e^{-2t}, e^{-3t} \rangle = \{C_1e^{-2t} + C_2e^{-3t} | C_1, C_2 \in \mathbb{R}\} = \{x | \ddot{x} + 5\dot{x} + 6x = 0\} \\ S_3 &= \langle e^{-3t}, e^{-4t} \rangle = \{C_1e^{-3t} + C_2e^{-4t} | C_1, C_2 \in \mathbb{R}\} = \{x | \ddot{x} + 7\dot{x} + 12x = 0\} \\ S_4 &= \langle e^{-4t}, e^{-5t} \rangle = \{C_1e^{-4t} + C_2e^{-5t} | C_1, C_2 \in \mathbb{R}\} = \{x | \ddot{x} + 9\dot{x} + 20x = 0\} \\ S_5 &= \langle e^{-5t}, e^{-6t} \rangle = \{C_1e^{-5t} + C_2e^{-6t} | C_1, C_2 \in \mathbb{R}\} = \{x | \ddot{x} + 11\dot{x} + 30x = 0\} \\ S_6 &= \langle e^{-6t}, e^{-t} \rangle = \{C_1e^{-6t} + C_2e^{-t} | C_1, C_2 \in \mathbb{R}\} = \{x | \ddot{x} + 7\dot{x} + 6x = 0\} \end{aligned}$$

Replacing each  $\Sigma_i$  by solution space  $S_i$  in Definition 1.2, we get a topological graph

$G^L[LDE_6^2]$  shown in Fig.11 on the linear homogeneous differential equation system  $(LDE_6^2)$ . Thus we can solve a system of linear homogeneous differential equations on its underlying graph  $G^L$ , no matter it is solvable or not in the classical sense.

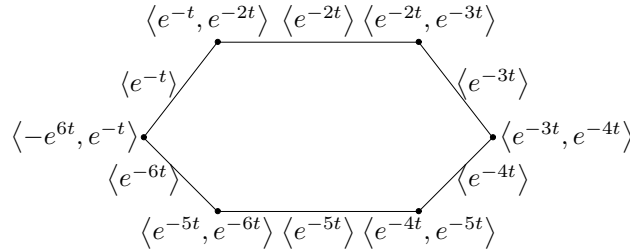

Fig.11

Generally, we know a result on  $G^L$ -solutions of homogeneous equations following.

**Theorem 4.3**([25]) *A linear homogeneous differential equation system  $(LDES_m^1)$  (or  $(LDE_m^n)$ ) has a unique  $G^L$ -solution, and for every  $H^L$  labeled with linear spaces  $\langle \bar{\beta}_i(t)e^{\alpha_i t}, 1 \leq i \leq n \rangle$  on vertices such that*

$$\langle \bar{\beta}_i(t)e^{\alpha_i t}, 1 \leq i \leq n \rangle \cap \langle \bar{\beta}_j(t)e^{\alpha_j t}, 1 \leq j \leq n \rangle \neq \emptyset$$

*if and only if there is an edge whose end vertices labeled by  $\langle \bar{\beta}_i(t)e^{\alpha_i t}, 1 \leq i \leq n \rangle$  and  $\langle \bar{\beta}_j(t)e^{\alpha_j t}, 1 \leq j \leq n \rangle$  respectively, then there is a unique linear homogeneous differential equation system  $(LDES_m^1)$  (or  $(LDE_m^n)$ ) with  $G^L$ -solution  $H^L$ , where  $\alpha_i$  is a  $k_i$ -fold zero of the characteristic equation,  $k_1 + k_2 + \dots + k_s = n$  and  $\bar{\beta}_i(t)$  is a polynomial in  $t$  with degree  $\leq k_i - 1$ .*

Applying  $G^L$ -solution, we classify such systems by graph isomorphisms.

**Definition 4.4** *A vertex-edge labeling  $\theta : G \rightarrow \mathbb{Z}^+$  is said to be integral if  $\theta(uv) \leq \min\{\theta(u), \theta(v)\}$  for  $\forall uv \in E(G)$ , denoted by  $G^{I_\theta}$ , and two integral labeled graphs  $G_1^{I_\theta}$  and  $G_2^{I_\tau}$  are called identical if  $G_1 \cong G_2$  and  $\theta(x) = \tau(\varphi(x))$  for any graph isomorphism  $\varphi$  and  $\forall x \in V(G_1) \cup E(G_1)$ , denoted by  $G_1^{I_\theta} = G_2^{I_\tau}$ .*

For example,  $G_1^{I_\theta} = G_2^{I_\tau}$  but  $G_1^{I_\theta} \neq G_3^{I_\sigma}$  for integral graphs shown in Fig.12.

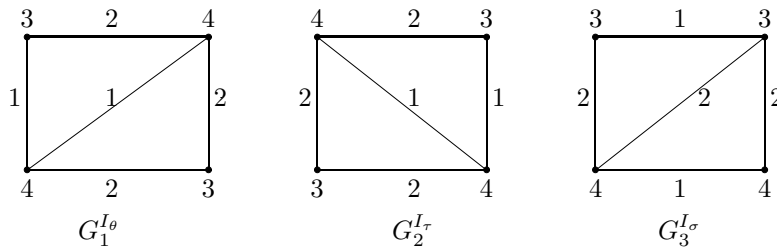

Fig.12



**Theorem 4.7**([28]) *A Cauchy problem on systems*

$$\begin{cases} F_1(x_1, x_2, \dots, x_n, u, p_1, p_2, \dots, p_n) = 0 \\ F_2(x_1, x_2, \dots, x_n, u, p_1, p_2, \dots, p_n) = 0 \\ \dots\dots\dots\dots\dots\dots\dots\dots\dots\dots\dots\dots\dots\dots\dots\dots\dots\dots \\ F_m(x_1, x_2, \dots, x_n, u, p_1, p_2, \dots, p_n) = 0 \end{cases}$$

of partial differential equations of first order is non-solvable with initial values

$$\begin{cases} x_i|_{x_n=x_n^0} = x_i^0(s_1, s_2, \dots, s_{n-1}) \\ u|_{x_n=x_n^0} = u_0(s_1, s_2, \dots, s_{n-1}) \\ p_i|_{x_n=x_n^0} = p_i^0(s_1, s_2, \dots, s_{n-1}), \quad i = 1, 2, \dots, n \end{cases}$$

if and only if the system

$$F_k(x_1, x_2, \dots, x_n, u, p_1, p_2, \dots, p_n) = 0, \quad 1 \leq k \leq m$$

is algebraically contradictory, in this case, there must be an integer  $k_0$ ,  $1 \leq k_0 \leq m$  such that

$$F_{k_0}(x_1^0, x_2^0, \dots, x_{n-1}^0, x_n^0, u_0, p_1^0, p_2^0, \dots, p_n^0) \neq 0$$

or it is differentially contradictory itself, i.e., there is an integer  $j_0$ ,  $1 \leq j_0 \leq n - 1$  such that

$$\frac{\partial u_0}{\partial s_{j_0}} - \sum_{i=1}^{n-1} p_i^0 \frac{\partial x_i^0}{\partial s_{j_0}} \neq 0.$$

According to Theorem 4.7, we know conditions for uniquely  $G^L$ -solution of Cauchy problem on system of partial differential equations of first order following.

**Theorem 4.8**([28]) *A Cauchy problem on system (PDES<sub>m</sub>) of partial differential equations of first order with initial values  $x_i^{[k^0]}, u_0^{[k]}, p_i^{[k^0]}$ ,  $1 \leq i \leq n$  for the  $k$ th equation in (PDES<sub>m</sub>),  $1 \leq k \leq m$  such that*

$$\frac{\partial u_0^{[k]}}{\partial s_j} - \sum_{i=1}^n p_i^{[k^0]} \frac{\partial x_i^{[k^0]}}{\partial s_j} = 0$$

is uniquely  $G^L$ -solvable, i.e.,  $G^L$ [PDES] is uniquely determined.

Applying the  $G^L$ -solution of a  $G^L$ -system ( $DES_m$ ) of differential equations, the global stability, i.e, sum-stable or prod-stable of ( $DES_m$ ) can be introduced. For example, the sum-stability of ( $DES_m$ ) is defined following.

**Definition 4.9** *Let ( $DES_m^C$ ) be a Cauchy problem on a system of differential equations in  $\mathbb{R}^n$ ,  $H^L \leq G^L [DES_m^C]$  a spanning subgraph, and  $u^{[v]}$  the solution of the  $v$ th equation with initial value  $u_0^{[v]}$ ,  $v \in V(H^L)$ . It is sum-stable on the subgraph  $H^L$  if for any number  $\varepsilon > 0$  there*

exists,  $\delta_v > 0$ ,  $v \in V(H^L)$  such that each  $G^L(t)$ -solution with

$$\left| u_0^{[v]} - u_0^{[v]} \right| < \delta_v, \quad \forall v \in V(H^L)$$

exists for all  $t \geq 0$  and the inequality

$$\left| \sum_{v \in V(H^L)} u^{[v]} - \sum_{v \in V(H^L)} u_0^{[v]} \right| < \varepsilon$$

holds, denoted by  $G^L[t] \stackrel{H}{\approx} G^L[0]$  and  $G^L[t] \stackrel{\Sigma}{\approx} G^L[0]$  if  $H^L = G^L[DES_m^C]$ . Furthermore, if there exists a number  $\beta_v > 0$ ,  $v \in V(H^L)$  such that every  $G^{L'}[t]$ -solution with

$$\left| u_0^{[v]} - u_0^{[v]} \right| < \beta_v, \quad \forall v \in V(H^L)$$

satisfies

$$\lim_{t \rightarrow \infty} \left| \sum_{v \in V(H)} u^{[v]} - \sum_{v \in V(H^L)} u_0^{[v]} \right| = 0,$$

then the  $G^L[t]$ -solution is called asymptotically stable, denoted by  $G^L[t] \stackrel{H}{\rightarrow} G^L[0]$  and  $G^L[t] \stackrel{\Sigma}{\rightarrow} G^L[0]$  if  $H^L = G^L[DES_m^C]$ .

For example, let the system  $(SDES_m^C)$  be

$$\left. \begin{aligned} \frac{\partial u}{\partial t} &= H_i(t, x_1, \dots, x_{n-1}, p_1, \dots, p_{n-1}) \\ u|_{t=t_0} &= u_0^{[i]}(x_1, x_2, \dots, x_{n-1}) \end{aligned} \right\} 1 \leq i \leq m \quad (SDES_m^C)$$

and a point  $X_0^{[i]} = (t_0, x_{10}^{[i]}, \dots, x_{(n-1)0}^{[i]})$  with  $H_i(t_0, x_{10}^{[i]}, \dots, x_{(n-1)0}^{[i]}) = 0$  for an integer  $1 \leq i \leq m$  is equilibrium of the  $i$ th equation in  $(SDES_m^C)$ . A result on the sum-stability of  $(SDES_m^C)$  is obtained in [30] following.

**Theorem 4.10**([28]) *Let  $X_0^{[i]}$  be an equilibrium point of the  $i$ th equation in  $(SDES_m^C)$  for each integer  $1 \leq i \leq m$ . If*

$$\sum_{i=1}^m H_i(X) > 0 \quad \text{and} \quad \sum_{i=1}^m \frac{\partial H_i}{\partial t} \leq 0$$

for  $X \neq \sum_{i=1}^m X_0^{[i]}$ , then the system  $(SDES_m^C)$  is sum-stable, i.e.,  $G^L[t] \stackrel{\Sigma}{\approx} G^L[0]$ .

Furthermore, if

$$\sum_{i=1}^m \frac{\partial H_i}{\partial t} < 0$$

for  $X \neq \sum_{i=1}^m X_0^{[i]}$ , then  $G^L[t] \stackrel{\Sigma}{\rightarrow} G^L[0]$ .



## §5. Field's Combinatorics

The modern physics characterizes particles by fields, such as those of scalar field, Maxwell field, Weyl field, Dirac field, Yang-Mills field, Einstein gravitational field,  $\dots$ , etc., which are in fact spacetime in geometry, isolated but non-combinatorics. Whence, the CC conjecture can bring us a combinatorial notion for developing field theory further, which enables us understanding the world and discussed extensively in the first edition of [13] in 2009, and references [18]-[20].

**Notion 5.1** *Characterize the geometrical structure, particularly, the underlying topological structure  $G^L[\mathcal{D}]$  of spacetime  $\mathcal{D}$  on all fields appeared in theoretical physics.*

Notice that the essence of Notion 5.1 is to characterize the geometrical spaces of particles. Whence, it is in fact equivalent to Notion 3.1.

**Notion 5.2** *For an integer  $m \geq 1$ , let  $\mathcal{D}_1, \mathcal{D}_2, \dots, \mathcal{D}_m$  be spacetimes in Definition 1.2 and  $\tilde{\mathcal{D}}$  underlying  $G^L[\tilde{\mathcal{D}}]$  with  $\tilde{\mathcal{D}} = \bigcup_{i=1}^m \mathcal{D}_i$ , i.e., a combinatorial spacetime. Select suitable Lagrangian or Hamiltonian density  $\tilde{\mathcal{L}}$  to determine field equations of  $\tilde{\mathcal{D}}$ , hold with the principle of covariance and characterize its global behaviors.*

There are indeed such fields, for instance the gravitational waves in Fig.13.

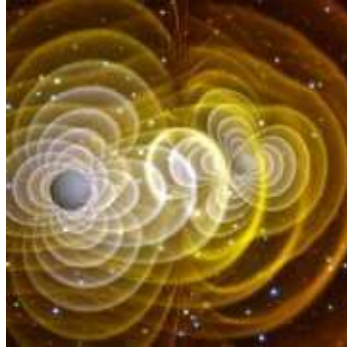

**Fig.13**

A combinatorial field  $\tilde{\mathcal{D}}$  is a combination of fields underlying a topological graph  $G^L$  with actions between fields. For this objective, a natural way is to characterize each field  $C_i$ ,  $1 \leq i \leq n$  of them by itself reference frame  $\{\bar{x}\}$ . Whence, the principles following are indispensable.

**Action Principle of Fields.** *There are always exist an action  $\vec{A}$  between two fields  $C_1$  and  $C_2$  of a combinatorial field if  $\dim(C_1 \cap C_2) \geq 1$ , which can be found at any point on a spatial direction in their intersection.*

Thus, a combinatorial field depends on graph  $G^L[\tilde{\mathcal{D}}]$ , such as those shown in Fig.14.

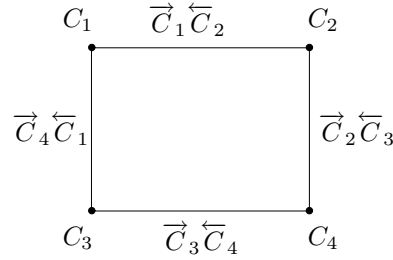

Fig.14

For understanding the world by combinatorial fields, the *anthropic principle*, i.e., *the born of human beings is not accidental but inevitable in the world* will applicable, which implies the generalized principle of covariance following.

**Generalized Principle of Covariance**([20]) *A physics law in a combinatorial field is invariant under all transformations on its coordinates, and all projections on its a subfield.*

Then, we can construct the Lagrangian density  $\tilde{\mathcal{L}}$  and find the field equations of combinatorial field  $\tilde{\mathcal{D}}$ , which are divided into two cases ([13], first edition).

**Case 1. Linear**

In this case, the expression of the Lagrange density  $\mathcal{L}_{GL}[\tilde{\mathcal{D}}]$  is

$$\mathcal{L}_{GL}[\tilde{\mathcal{D}}] = \sum_{i=1}^n a_i \mathcal{L}_{\mathcal{D}_i} + \sum_{(\mathcal{D}_i, \mathcal{D}_j) \in E(G^L[\tilde{\mathcal{D}}])} b_{ij} \mathcal{I}_{ij} ,$$

where  $a_i, b_{ij}$  are coupling constants determined only by experiments.

**Case 2. Non-Linear**

In this case, the Lagrange density  $\mathcal{L}_{GL}[\tilde{\mathcal{D}}]$  is a non-linear function on  $\mathcal{L}_{\mathcal{D}_i}$  and  $\mathcal{I}_{ij}$  for  $1 \leq i, j \leq n$ . Let the minimum and maximum indexes  $j$  for  $(M_i, M_j) \in E(G^L[\tilde{\mathcal{D}}])$  are  $i^l$  and  $i^u$ , respectively. Denote by

$$\bar{x} = (x_1, x_2, \dots) = (\mathcal{L}_{\mathcal{D}_1}, \mathcal{L}_{\mathcal{D}_2}, \dots, \mathcal{L}_{\mathcal{D}_n}, \mathcal{I}_{11^l}, \dots, \mathcal{I}_{11^u}, \dots, \mathcal{I}_{22^l}, \dots) .$$

If  $\mathcal{L}_{GL}[\tilde{\mathcal{D}}]$  is  $k + 1$  differentiable,  $k \geq 0$ , by Taylor’s formula we know that

$$\begin{aligned} \mathcal{L}_{GL}[\tilde{\mathcal{D}}] &= \mathcal{L}_{GL}[\tilde{\mathcal{D}}](\bar{0}) + \sum_{i=1}^n \left[ \frac{\partial \mathcal{L}_{GL}[\tilde{\mathcal{D}}]}{\partial x_i} \right]_{x_i=0} x_i + \frac{1}{2!} \sum_{i,j=1}^n \left[ \frac{\partial^2 \mathcal{L}_{GL}[\tilde{\mathcal{D}}]}{\partial x_i \partial x_j} \right]_{x_i, x_j=0} x_i x_j \\ &+ \dots + \frac{1}{k!} \sum_{i_1, i_2, \dots, i_k=1}^n \left[ \frac{\partial^k \mathcal{L}_{GL}[\tilde{\mathcal{D}}]}{\partial x_{i_1} \partial x_{i_2} \dots \partial x_{i_k}} \right]_{x_{i_j}=0, 1 \leq j \leq k} x_{i_1} x_{i_2} \dots x_{i_k} \\ &+ R(x_1, x_2, \dots), \end{aligned}$$

where

$$\lim_{\|\bar{x}\| \rightarrow 0} \frac{R(x_1, x_2, \dots)}{\|\bar{x}\|} = 0,$$

and choose the first  $k$  terms

$$\begin{aligned} & \mathcal{L}_{G^L[\tilde{\mathcal{D}}]}(\bar{0}) + \sum_{i=1}^n \left[ \frac{\partial \mathcal{L}_{G^L[\tilde{\mathcal{D}}]}}{\partial x_i} \right]_{x_i=0} x_i + \frac{1}{2!} \sum_{i,j=1}^n \left[ \frac{\partial^2 \mathcal{L}_{G^L[\tilde{\mathcal{D}}]}}{\partial x_i \partial x_j} \right]_{x_i, x_j=0} x_i x_j \\ & + \dots + \frac{1}{k!} \sum_{i_1, i_2, \dots, i_k=1}^n \left[ \frac{\partial^k \mathcal{L}_{G^L[\tilde{\mathcal{D}}]}}{\partial x_{i_1} \partial x_{i_2} \dots \partial x_{i_k}} \right]_{x_{i_j}=0, 1 \leq j \leq k} x_{i_1} x_{i_2} \dots x_{i_k} \end{aligned}$$

to be the asymptotic value of Lagrange density  $\mathcal{L}_{G^L[\tilde{\mathcal{D}}]}$ , particularly, the linear parts

$$\mathcal{L}_{G^L[\tilde{\mathcal{D}}]}(\bar{0}) + \sum_{i=1}^n \left[ \frac{\partial \mathcal{L}_{G^L[\tilde{\mathcal{D}}]}}{\partial \mathcal{L}_{\mathcal{D}_i}} \right]_{\mathcal{L}_{\mathcal{D}_i}=0} \mathcal{L}_{M_i} + \sum_{(M_i, M_j) \in E(G^L[\tilde{M}])} \left[ \frac{\partial \mathcal{L}_{G^L[\tilde{\mathcal{D}}]}}{\partial \mathcal{F}_{ij}} \right]_{\mathcal{F}_{ij}=0} \mathcal{F}_{ij}.$$

Notice that such a Lagrange density maybe intersects. We need to consider those of Lagrange densities without intersections. For example,

$$\mathcal{L}_{G^L[\tilde{\mathcal{D}}]} = \sum_{i=1}^4 \mathcal{L}_{C_i}^2 - \sum_{i=1}^4 \mathcal{L}_{\bar{C}_i} \bar{C}_{i+1}$$

for the combinatorial field shown in Fig.14.

Then, applying the Euler-Lagrange equations, i.e.,

$$\partial_\mu \frac{\partial \mathcal{L}_{G^L[\tilde{\mathcal{D}}]}}{\partial \partial_\mu \phi_{\tilde{\mathcal{D}}}} - \frac{\partial \mathcal{L}_{G^L[\tilde{\mathcal{D}}]}}{\partial \phi_{\tilde{\mathcal{D}}}} = 0,$$

where  $\phi_{\tilde{\mathcal{D}}}$  is the wave function of combinatorial field  $\tilde{\mathcal{D}}(t)$ , we are easily find the equations of combinatorial field  $\tilde{\mathcal{D}}$ .

For example, for a combinatorial scalar field  $\phi_{\tilde{\mathcal{D}}}$ , without loss of generality let

$$\begin{aligned} \phi_{\tilde{\mathcal{D}}} &= \sum_{i=1}^n c_i \phi_{\mathcal{D}_i} \\ \mathcal{L}_{G^L[\tilde{\mathcal{D}}]} &= \frac{1}{2} \sum_{i=1}^n (\partial_{\mu_i} \phi_{\mathcal{D}_i} \partial^{\mu_i} \phi_{\mathcal{D}_i} - m_i^2 \phi_{\mathcal{D}_i}^2) + \sum_{(\mathcal{D}_i, \mathcal{D}_j) \in E(G^L[\tilde{\mathcal{D}}])} b_{ij} \phi_{\mathcal{D}_i} \phi_{\mathcal{D}_j}, \end{aligned}$$

i.e., linear case

$$\mathcal{L}_{G^L[\tilde{\mathcal{D}}]} = \sum_{i=1}^n \mathcal{L}_{\mathcal{D}_i} + \sum_{(\mathcal{D}_i, \mathcal{D}_j) \in E(G^L[\tilde{\mathcal{D}}])} b_{ij} \mathcal{F}_{ij}$$

with  $\mathcal{L}_{\mathcal{D}_i} = \frac{1}{2} (\partial_{\mu_i} \phi_{\mathcal{D}_i} \partial^{\mu_i} \phi_{\mathcal{D}_i} - m_i^2 \phi_{\mathcal{D}_i}^2)$ ,  $\mathcal{F}_{ij} = \phi_{\mathcal{D}_i} \phi_{\mathcal{D}_j}$ ,  $\mu_i = \mu_{\mathcal{D}_i}$  and constants  $b_{ij}$ ,  $m_i$ ,  $c_i$  for

integers  $1 \leq i, j \leq n$ . Then the equation of combinatorial scalar field is

$$\sum_{i=1}^n \frac{1}{c_i} (\partial_\mu \partial^{\mu_i} + m_i^2) \phi_{M_i} - \sum_{(M_i, M_j) \in E(G^L[\widetilde{M}])} b_{ij} \left( \frac{\phi_{M_j}}{c_i} + \frac{\phi_{M_i}}{c_j} \right) = 0.$$

Similarly, we can determine the equations on combinatorial Maxwell field, Weyl field, Dirac field, Yang-Mills field and Einstein gravitational field in theory. For more such conclusions, the reader is refers to references [13], [18]-[20] in details.

Notice that the *string theory* even if arguing endlessly by physicists, it is in fact a combinatorial field  $\mathbb{R}^4 \times \mathbb{R}^7$  under supersymmetries, and the same also happens to the unified field theory such as those in the gauge field of Weinberg-Salam on Higgs mechanism. Even so, Notions 5.1 and 5.2 produce developing space for physics, merely with examining by experiment.

### §6. Conclusions

The role of CC conjecture to mathematical sciences has been shown in previous sections by examples of results. Actually, it is a mathematical machinery of philosophical notion: *there always exist universal connection between things  $\mathcal{S}$  with a disguise  $G^L[\mathcal{S}]$  on connections, which enables us converting a mathematical system with contradictions to a compatible one ([27]), and opens thoroughly new ways for developing mathematical sciences. However, is a topological graph an element of a mathematical system with measures, not only viewed as a geometrical figure?* The answer is YES!

Recently, the author introduces  $\vec{G}$ -flow in [29], i.e., an oriented graph  $\vec{G}$  embedded in a topological space  $\mathcal{S}$  associated with an injective mappings  $L : (u, v) \rightarrow L(u, v) \in \mathcal{V}$  such that  $L(u, v) = -L(v, u)$  for  $\forall (u, v) \in X(\vec{G})$  holding with conservation laws

$$\sum_{u \in N_G(v)} L(v, u) = \mathbf{0} \quad \text{for } \forall v \in V(\vec{G}),$$

where  $V$  is a Banach space over a field  $\mathcal{F}$  and showed all these  $\vec{G}$ -flows  $\vec{G}^\mathcal{V}$  form a Banach space by defining

$$\|\vec{G}^L\| = \sum_{(u,v) \in X(\vec{G})} \|L(u, v)\|$$

for  $\forall \vec{G}^L \in \vec{G}^\mathcal{V}$ , and furthermore, Hilbert space by introducing inner product similarly, where  $\|L(u, v)\|$  denotes the norm of  $F(u^v)$  in  $\mathcal{V}$ , which enables us to get  $\vec{G}$ -flow solutions, i.e., combinatorial solutions on differential equations.

### References

- [1] G.Birkhoff and S.MacLane, *A Survey of Modern Algebra* (4th edition), Macmillan Publishing Co., Inc, 1977.

- [2] H.Everett, Relative state formulation of quantum mechanics, *Rev.Mod.Phys.*, 29(1957), 454-462.
- [3] J.L.Gross and T.W.Tucker, *Topological Graph Theory*, John Wiley & Sons, 1987.
- [4] Fritz John. *Partial Differential Equations*(4th Edition). New York, USA: Springer-Verlag, 1982.
- [5] John M.Lee, *Introduction to Topological Manifolds*, Springer-Verlag New York, Inc., 2000.
- [6] Tian Ma and Shouhong Wang, Unified field equations coupling four forces and principle of interaction dynamics, *arXiv*: 1210.0448.
- [7] Tian Ma and Shouhong Wang, Unified field theory and principle of representation invariance, *arXiv*: 1212.4893.
- [8] P.L.Maggu, On introduction of bigroup concept with its applications industry, *Pure Appl. Math. Sic.*, 39(1994), 171-173.
- [9] Linfan Mao, *On the Automorphisms of Maps & Klein Surfaces*, a post doctoral report for Chinese Academy of Sciences, 2005.
- [10] Linfan Mao, On Automorphisms groups of Maps, Surfaces and Smarandache geometries, *Sientia Magna*, Vol.1, No.2(2005), 55-73.
- [11] Linfan Mao, *Automorphism Groups of Maps, Surfaces and Smarandache Geometries*, First edition published by American Research Press in 2005, Second edition is as a Graduate Textbook in Mathematics, Published by The Education Publisher Inc., USA, 2011.
- [12] Linfan Mao, *Smarandache Multi-Space Theory*(Second edition), First edition published by Hexis, Phoenix in 2006, Second edition is as a Graduate Textbook in Mathematics, Published by The Education Publisher Inc., USA, 2011.
- [13] Linfan Mao, *Combinatorial Geometry with Applications to Field Theory*, First edition published by InfoQuest in 2009, Second edition is as a Graduate Textbook in Mathematics, Published by The Education Publisher Inc., USA, 2011.
- [14] Linfan Mao, Combinatorial speculation and combinatorial conjecture for mathematics, *International J.Math. Combin.* Vol.1(2007), No.1, 1-19.
- [15] Linfan Mao, Geometrical theory on combinatorial manifolds, *JP J.Geometry and Topology*, Vol.7, No.1(2007),65-114.
- [16] Linfan Mao, Extending homomorphism theorem to multi-systems, *International J.Math. Combin.*, Vol.3(2008), 1-27.
- [17] Linfan Mao, Action of multi-groups on finite multi-sets, *International J.Math. Combin.*, Vol.3(2008), 111-121.
- [18] Linfan Mao, Curvature equations on combinatorial manifolds with applications to theoretical physics, *International J.Math. Combin.*, Vol.1 (2008), 16-35
- [19] Linfan Mao, Combinatorial fields-an introduction, *International J. Math. Combin.*, Vol.1(2009), Vol.3, 1-22.
- [20] Linfan Mao, Relativity in combinatorial gravitational fields, *Progress in Physics*, Vol.3(2010), 39-50.
- [21] Linfan Mao, A combinatorial decomposition of Euclidean space  $\mathbb{R}^n$  with contribution to visibility, *International J.Math. Combin.*, Vol.1(2010), 47-64.

- [22] Linfan Mao, Graph structure of manifolds with listing, *International J. Contemp. Math. Sciences*, Vol.5, 2011, No.2,71-85.
- [23] Linfan Mao, A generalization of Seifert-Van Kampen theorem for fundamental groups, *Far East Journal of Math. Sciences*, Vol.61 No.2 (2012), 141-160.
- [24] Linfan Mao, Non-solvable spaces of linear equation systems, *International J. Math. Combin.*, Vol.2 (2012), 9-23.
- [25] Linfan Mao, Global stability of non-solvable ordinary differential equations with applications, *International J. Math. Combin.*, Vol.1 (2013), 1-37.
- [26] Linfan Mao, Geometry on  $G^L$ -systems of homogenous polynomials, *International J. Contemp. Math. Sciences*, Vol.9 (2014), No.6, 287-308.
- [27] Linfan Mao, Mathematics on non-mathematics - A combinatorial contribution, *International J. Math. Combin.*, Vol.3(2014), 1-34.
- [28] Linfan Mao, Cauchy problem on non-solvable system of first order partial differential equations with applications, *Methods and Applications of Analysis*, Vol.22, 2(2015), 171-200.
- [29] Linfan Mao, Extended Banach  $\overrightarrow{G}$ -flow spaces on differential equations with applications, *Electronic J. Mathematical Analysis and Applications*, Vol.3, No.2 (2015), 59-90.
- [30] F.Smarandache, *Paradoxist Geometry*, State Archives from Valcea, Rm. Valcea, Romania, 1969, and in *Paradoxist Mathematics*, Collected Papers (Vol. II), Kishinev University Press, Kishinev, 5-28, 1997.
- [31] F.Smarandache, Multi-space and multi-structure, in *Neutrosophy. Neutrosophic Logic, Set, Probability and Statistics*, American Research Press, 1998.
- [32] J.Stillwell, *Classical Topology and Combinatorial Group Theory*, Springer-Verlag New York Inc., 1980.
- [33] W.B.Vasantha Kandasmy, *Bialgebraic Structure and Smarandache Bialgebraic Structure*, American Research Press, 2003.
- [34] Wolfgang Walter, *Ordinary Differential Equations*, Springer-Verlag New York, Inc., 1998.
- [35] A.Yu.Kamenshchil and O.V.Teryaev, Many-worlds interpretation of quantum theory and mesoscopic anthropic principle, *Concepts of Physics*, Vol.V, 4(2008), 575-592.

## Chapter 4 Envelope Mathematics on Reality

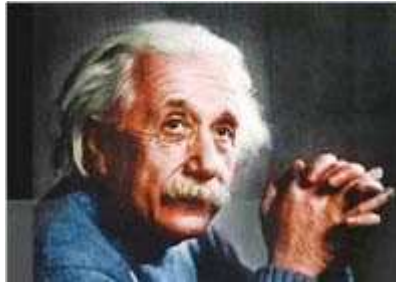

*Thinking the development of the world, in a sense, is constantly out of marvel.*

By Albert Einstein, an American theoretical physicist.

## Extended Banach $\vec{G}$ -Flow Spaces on Differential Equations with Applications

**Abstract:** Let  $\mathcal{V}$  be a Banach space over a field  $\mathcal{F}$ . A  $\vec{G}$ -flow is a graph  $\vec{G}$  embedded in a topological space  $\mathcal{S}$  associated with an injective mappings  $L : u^v \rightarrow L(u^v) \in \mathcal{V}$  such that  $L(u^v) = -L(v^u)$  for  $\forall (u, v) \in X(\vec{G})$  holding with conservation laws

$$\sum_{u \in N_G(v)} L(v^u) = \mathbf{0} \quad \text{for } \forall v \in V(\vec{G}),$$

where  $u^v$  denotes the semi-arc of  $(u, v) \in X(\vec{G})$ , which is a mathematical object for things embedded in a topological space. The main purpose of this paper is to extend Banach spaces on topological graphs with operator actions and show all of these extensions are also Banach space with a bijection with a bijection between linear continuous functionals and elements, which enables one to solve linear functional equations in such extended space, particularly, solve algebraic, differential or integral equations on a topological graph, find multi-space solutions on equations, for instance, the Einstein’s gravitational equations. A few well-known results in classical mathematics are generalized such as those of the fundamental theorem in algebra, Hilbert and Schmidt’s result on integral equations, and the stability of such  $\vec{G}$ -flow solutions with applications to ecologically industrial systems are also discussed in this paper.

**Key Words:** Banach space, topological graph, conservation flow, topological graph, differential flow, multispace solution of equation, system control.

**AMS(2010):** 05C78,34A26,35A08,46B25,46E22,51D20

### §1. Introduction

Let  $\mathcal{V}$  be a Banach space over a field  $\mathcal{F}$ . All graphs  $\vec{G}$ , denoted by  $(V(\vec{G}), X(\vec{G}))$  considered in this paper are strong-connected without loops. A *topological graph*  $\vec{G}$  is an embedding of an oriented graph  $\vec{G}$  in a topological space  $\mathcal{C}$ . All elements in  $V(\vec{G})$  or  $X(\vec{G})$  are respectively called vertices or arcs of  $\vec{G}$ . An arc  $e = (u, v) \in X(\vec{G})$  can be divided into 2 semi-arcs, i.e., initial semi-arc  $u^v$  and end semi-arc  $v^u$ , such as those shown in Fig.1 following.

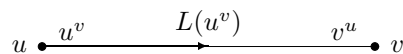

**Fig.1**

---

<sup>1</sup>*Electronic Journal of Mathematical Analysis and Applications*, Vol. 3(2) July 2015, pp. 59-91.



All these semi-arcs of a topological graph  $\vec{G}$  are denoted by  $X_{\frac{1}{2}}(\vec{G})$ .

A vector labeling  $\vec{G}^L$  on  $\vec{G}$  is a 1-1 mapping  $L : \vec{G} \rightarrow \mathcal{V}$  such that  $L : u^v \rightarrow L(u^v) \in \mathcal{V}$  for  $\forall u^v \in X_{\frac{1}{2}}(\vec{G})$ , such as those shown in Fig.1. For all labelings  $\vec{G}^L$  on  $\vec{G}$ , define

$$\vec{G}^{L_1} + \vec{G}^{L_2} = \vec{G}^{L_1+L_2} \quad \text{and} \quad \lambda \vec{G}^L = \vec{G}^{\lambda L}.$$

Then, all these vector labelings on  $\vec{G}$  naturally form a vector space. Particularly, a  $\vec{G}$ -flow on  $\vec{G}$  is such a labeling  $L : u^v \rightarrow \mathcal{V}$  for  $\forall u^v \in X_{\frac{1}{2}}(\vec{G})$  hold with  $L(u^v) = -L(v^u)$  and conservation laws

$$\sum_{u \in N_G(v)} L(v^u) = \mathbf{0}$$

for  $\forall v \in V(\vec{G})$ , where  $\mathbf{0}$  is the zero-vector in  $\mathcal{V}$ . For example, a conservation law for vertex  $v$  in Fig.2 is  $-L(v^{u_1}) - L(v^{u_2}) - L(v^{u_3}) + L(v^{u_4}) + L(v^{u_5}) + L(v^{u_6}) = \mathbf{0}$ .

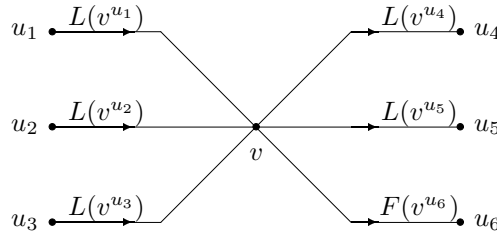

Fig.2

Clearly, if  $\mathcal{V} = \mathbb{Z}$  and  $\mathcal{O} = \{1\}$ , then the  $\vec{G}$ -flow  $\vec{G}^L$  is nothing else but the network flow  $X(\vec{G}) \rightarrow \mathbb{Z}$  on  $\vec{G}$ .

Let  $\vec{G}^L, \vec{G}^{L_1}, \vec{G}^{L_2}$  be  $\vec{G}$ -flows on a topological graph  $\vec{G}$  and  $\xi \in \mathcal{F}$  a scalar. It is clear that  $\vec{G}^{L_1} + \vec{G}^{L_2}$  and  $\xi \cdot \vec{G}^L$  are also  $\vec{G}$ -flows, which implies that all conservation  $\vec{G}$ -flows on  $\vec{G}$  also form a linear space over  $\mathcal{F}$  with unit  $\vec{G}^{\mathbf{0}}$  under operations  $+$  and  $\cdot$ , denoted by  $\vec{G}^{\mathcal{V}}$ , where  $\vec{G}^{\mathbf{0}}$  is such a  $\vec{G}$ -flow with vector  $\mathbf{0}$  on  $u^v$  for  $(u, v) \in X(\vec{G})$ , denoted by  $\mathbf{0}$  if  $\vec{G}$  is clear by in the context.

The flow representation for graphs are first discussed in [5], and then applied to differential operators in [6], which has shown its important role both in mathematics and applied sciences. It should be noted that a conservation law naturally determines an autonomous systems in the world. We can also find  $\vec{G}$ -flows by solving conservation equations

$$\sum_{u \in N_G(v)} L(v^u) = \mathbf{0}, \quad v \in V(\vec{G}).$$

Such a system of equations is non-solvable in general, only with  $\vec{G}$ -flow solutions such as those discussions in references [10]-[19]. Thus we can also introduce  $\vec{G}$ -flows by Smarandache multisystem ([21]-[22]). In fact, for any integer  $m \geq 1$  let  $(\vec{\Sigma}; \vec{\mathcal{R}})$  be a Smarandache multisystem consisting of  $m$  mathematical systems  $(\Sigma_1; \mathcal{R}_1), (\Sigma_2; \mathcal{R}_2), \dots, (\Sigma_m; \mathcal{R}_m)$ , different two by two.

A topological structure  $G^L \left[ \tilde{\Sigma}; \tilde{\mathcal{R}} \right]$  on  $(\tilde{\Sigma}; \tilde{\mathcal{R}})$  is inherited by

$$\begin{aligned} V \left( G^L \left[ \tilde{\Sigma}; \tilde{\mathcal{R}} \right] \right) &= \{ \Sigma_1, \Sigma_2, \dots, \Sigma_m \}, \\ E \left( G^L \left[ \tilde{\Sigma}; \tilde{\mathcal{R}} \right] \right) &= \{ (\Sigma_i, \Sigma_j) \mid \Sigma_i \cap \Sigma_j \neq \emptyset, 1 \leq i \neq j \leq m \} \text{ with labeling} \\ L : \Sigma_i &\rightarrow L(\Sigma_i) = \Sigma_i \quad \text{and} \quad L : (\Sigma_i, \Sigma_j) \rightarrow L(\Sigma_i, \Sigma_j) = \Sigma_i \cap \Sigma_j \end{aligned}$$

for integers  $1 \leq i \neq j \leq m$ , i.e., a topological vertex-edge labeled graph. Clearly,  $G^L \left[ \tilde{\Sigma}; \tilde{\mathcal{R}} \right]$  is a  $\vec{G}$ -flow if  $\Sigma_i \cap \Sigma_j = \mathbf{v} \in \mathcal{V}$  for integers  $1 \leq i, j \leq m$ .

The main purpose of this paper is to establish the theoretical foundation, i.e., extending Banach spaces, particularly, Hilbert spaces on topological graphs with operator actions and show all of these extensions are also Banach space with a bijection between linear continuous functionals and elements, which enables one to solve linear functional equations in such extended space, particularly, solve algebraic or differential equations on a topological graph, i.e., find multi-space solutions for equations, such as those of algebraic equations, the Einstein gravitational equations and integral equations with applications to controlling of ecologically industrial systems. All of these discussions provide new viewpoint for mathematical elements, i.e., mathematical combinatorics.

For terminologies and notations not mentioned in this section, we follow references [1] for functional analysis, [3] and [7] for topological graphs, [4] for linear spaces, [8]-[9], [21]-[22] for Smarandache multi-systems, [3], [20] and [23] for differential equations.

## §2. $\vec{G}$ -Flow Spaces

### 2.1 Existence

**Definition 2.1** Let  $\mathcal{V}$  be a Banach space. A family  $V$  of vectors  $\mathbf{v} \in \mathcal{V}$  is conservative if

$$\sum_{\mathbf{v} \in V} \mathbf{v} = \mathbf{0},$$

called a conservative family.

Let  $\mathcal{V}$  be a Banach space over a field  $\mathcal{F}$  with a basis  $\{\alpha_1, \alpha_2, \dots, \alpha_{\dim \mathcal{V}}\}$ . Then, for  $\mathbf{v} \in V$  there are scalars  $x_1^{\mathbf{v}}, x_2^{\mathbf{v}}, \dots, x_{\dim \mathcal{V}}^{\mathbf{v}} \in \mathcal{F}$  such that

$$\mathbf{v} = \sum_{i=1}^{\dim \mathcal{V}} x_i^{\mathbf{v}} \alpha_i.$$

Consequently,

$$\sum_{\mathbf{v} \in V} \sum_{i=1}^{\dim \mathcal{V}} x_i^{\mathbf{v}} \alpha_i = \sum_{i=1}^{\dim \mathcal{V}} \left( \sum_{\mathbf{v} \in V} x_i^{\mathbf{v}} \right) \alpha_i = \mathbf{0}$$

implies that

$$\sum_{\mathbf{v} \in V} x_i^{\mathbf{v}} = 0$$

for integers  $1 \leq i \leq \dim \mathcal{V}$ .

Conversely, if

$$\sum_{\mathbf{v} \in V} x_i^{\mathbf{v}} = 0, \quad 1 \leq i \leq \dim \mathcal{V},$$

define

$$\mathbf{v}^i = \sum_{i=1}^{\dim \mathcal{V}} x_i^{\mathbf{v}} \alpha_i$$

and  $V = \{\mathbf{v}^i, 1 \leq i \leq \dim \mathcal{V}\}$ . Clearly,  $\sum_{\mathbf{v} \in V} \mathbf{v} = \mathbf{0}$ , i.e.,  $V$  is a family of conservation vectors.

Whence, if denoted by  $x_i^{\mathbf{v}} = (\mathbf{v}, \alpha_i)$  for  $\forall \mathbf{v} \in V$ , we therefore get a condition on families of conservation in  $\mathcal{V}$  following.

**Theorem 2.2** *Let  $\mathcal{V}$  be a Banach space with a basis  $\{\alpha_1, \alpha_2, \dots, \alpha_{\dim \mathcal{V}}\}$ . Then, a vector family  $V \subset \mathcal{V}$  is conservation if and only if*

$$\sum_{\mathbf{v} \in V} (\mathbf{v}, \alpha_i) = 0$$

for integers  $1 \leq i \leq \dim \mathcal{V}$ .

For example, let  $V = \{\mathbf{v}_1, \mathbf{v}_2, \mathbf{v}_3, \mathbf{v}_4\} \subset \mathbb{R}^3$  with

$$\begin{aligned} \mathbf{v}_1 &= (1, 1, 1), & \mathbf{v}_2 &= (-1, 1, 1), \\ \mathbf{v}_3 &= (1, -1, -1), & \mathbf{v}_4 &= (-1, -1, -1) \end{aligned}$$

Then it is a conservation family of vectors in  $\mathbb{R}^3$ .

Clearly, a conservation flow consists of conservation families. The following result establishes its inverse.

**Theorem 2.3.** *A  $\vec{G}$ -flow  $\vec{G}^L$  exists on  $\vec{G}$  if and only if there are conservation families  $L(v)$  in a Banach space  $\mathcal{V}$  associated an index set  $V$  with*

$$L(v) = \{L(v^u) \in \mathcal{V} \text{ for some } u \in V\}$$

such that  $L(v^u) = -L(u^v)$  and

$$L(v) \cap (-L(u)) = L(v^u) \text{ or } \emptyset.$$

*Proof* Notice that

$$\sum_{u \in N_G(v)} L(v^u) = \mathbf{0}$$

for  $\forall v \in V \left( \vec{G} \right)$  implies

$$L(v^u) = - \sum_{w \in N_G(v) \setminus \{u\}} L(v^w).$$

Whence, if there is an index set  $V$  associated conservation families  $L(v)$  with

$$L(v) = \{L(v^u) \in \mathcal{V} \text{ for some } u \in V\}$$

for  $\forall v \in V$  such that  $L(v^u) = -L(u^v)$  and  $L(v) \cap (-L(u)) = L(v^u)$  or  $\emptyset$ , define a topological graph  $\vec{G}$  by

$$V(\vec{G}) = V \text{ and } X(\vec{G}) = \bigcup_{v \in V} \{(v, u) | L(v^u) \in L(v)\}$$

with an orientation  $v \rightarrow u$  on its each arcs. Then, it is clear that  $\vec{G}^L$  is a  $\vec{G}$ -flow by definition.

Conversely, if  $\vec{G}^L$  is a  $\vec{G}$ -flow, let

$$L(v) = \{L(v^u) \in \mathcal{V} \text{ for } \forall (v, u) \in X(\vec{G})\}$$

for  $\forall v \in V(\vec{G})$ . Then, it is also clear that  $L(v)$ ,  $v \in V(\vec{G})$  are conservation families associated with an index set  $V = V(\vec{G})$  such that  $L(v, u) = -L(u, v)$  and

$$L(v) \cap (-L(u)) = \begin{cases} L(v^u) & \text{if } (v, u) \in X(\vec{G}) \\ \emptyset & \text{if } (v, u) \notin X(\vec{G}) \end{cases}$$

by definition. □

Theorems 2.2 and 2.3 enables one to get the following result.

**Corollary 2.4.** *There are always existing  $\vec{G}$ -flows on a topological graph  $\vec{G}$  with weights  $\lambda v$  for  $v \in \mathcal{V}$ , particularly,  $\lambda_e \alpha_i$  on  $\forall e \in X(\vec{G})$  if  $|X(\vec{G})| \geq |V(\vec{G})| + 1$ .*

*Proof* Let  $e = (u, v) \in X(\vec{G})$ . By Theorems 2.2 and 2.3, for an integer  $1 \leq i \leq \dim \mathcal{V}$ , such a  $\vec{G}$ -flow exists if and only if the system of linear equations

$$\sum_{u \in V(\vec{G})} \lambda_{(v,u)} = 0, \quad v \in V(\vec{G})$$

is solvable. However, if  $|X(\vec{G})| \geq |V(\vec{G})| + 1$ , such a system is indeed solvable by linear algebra. □

## 2.2 $\vec{G}$ -Flow Spaces

Define

$$\|\vec{G}^L\| = \sum_{(u,v) \in X(\vec{G})} \|L(u^v)\|$$

for  $\forall \vec{G}^L \in \vec{G}^{\mathcal{V}}$ , where  $\|L(u^v)\|$  is the norm of  $F(u^v)$  in  $\mathcal{V}$ . Then

$$(1) \quad \|\vec{G}^L\| \geq 0 \text{ and } \|\vec{G}^L\| = 0 \text{ if and only if } \vec{G}^L = \vec{G}^{\mathbf{0}} = \mathbf{O}.$$

$$(2) \quad \|\vec{G}^{\xi L}\| = \xi \|\vec{G}^L\| \text{ for any scalar } \xi.$$

$$(3) \quad \|\vec{G}^{L_1} + \vec{G}^{L_2}\| \leq \|\vec{G}^{L_1}\| + \|\vec{G}^{L_2}\| \text{ because of}$$

$$\begin{aligned} \|\vec{G}^{L_1} + \vec{G}^{L_2}\| &= \sum_{(u,v) \in X(\vec{G})} \|L_1(u^v) + L_2(u^v)\| \\ &\leq \sum_{(u,v) \in X(\vec{G})} \|L_1(u^v)\| + \sum_{(u,v) \in X(\vec{G})} \|L_2(u^v)\| = \|\vec{G}^{L_1}\| + \|\vec{G}^{L_2}\|. \end{aligned}$$

Whence,  $\|\cdot\|$  is a norm on linear space  $\vec{G}^{\mathcal{Y}}$ .

Furthermore, if  $\mathcal{Y}$  is an inner space with inner product  $\langle \cdot, \cdot \rangle$ , define

$$\langle \vec{G}^{L_1}, \vec{G}^{L_2} \rangle = \sum_{(u,v) \in X(\vec{G})} \langle L_1(u^v), L_2(u^v) \rangle.$$

Then we know that

$$(4) \quad \langle \vec{G}^L, \vec{G}^L \rangle = \sum_{(u,v) \in X(\vec{G})} \langle L(u^v), L(u^v) \rangle \geq 0 \text{ and } \langle \vec{G}^L, \vec{G}^L \rangle = 0 \text{ if and only if } L(u^v) = 0 \text{ for } \forall (u,v) \in X(\vec{G}), \text{ i.e., } \vec{G}^L = \mathbf{O}.$$

$$(5) \quad \langle \vec{G}^{L_1}, \vec{G}^{L_2} \rangle = \overline{\langle \vec{G}^{L_2}, \vec{G}^{L_1} \rangle} \text{ for } \forall \vec{G}^{L_1}, \vec{G}^{L_2} \in \vec{G}^{\mathcal{Y}} \text{ because of}$$

$$\begin{aligned} \langle \vec{G}^{L_1}, \vec{G}^{L_2} \rangle &= \sum_{(u,v) \in X(\vec{G})} \langle L_1(u^v), L_2(u^v) \rangle = \sum_{(u,v) \in X(\vec{G})} \overline{\langle L_2(u^v), L_1(u^v) \rangle} \\ &= \overline{\sum_{(u,v) \in X(\vec{G})} \langle L_2(u^v), L_1(u^v) \rangle} = \overline{\langle \vec{G}^{L_2}, \vec{G}^{L_1} \rangle} \end{aligned}$$

$$(6) \quad \text{For } \vec{G}^L, \vec{G}^{L_1}, \vec{G}^{L_2} \in \vec{G}^{\mathcal{Y}}, \text{ there is}$$

$$\begin{aligned} &\langle \lambda \vec{G}^{L_1} + \mu \vec{G}^{L_2}, \vec{G}^L \rangle \\ &= \lambda \langle \vec{G}^{L_1}, \vec{G}^L \rangle + \mu \langle \vec{G}^{L_2}, \vec{G}^L \rangle \end{aligned}$$

because of

$$\begin{aligned}
\langle \lambda \vec{G}^{L_1} + \mu \vec{G}^{L_2}, \vec{G}^L \rangle &= \langle \vec{G}^{\lambda L_1} + \vec{G}^{\mu L_2}, \vec{G}^L \rangle \\
&= \sum_{(u,v) \in X(\vec{G})} \langle \lambda L_1(u^v) + \mu L_2(u^v), L(u^v) \rangle \\
&= \sum_{(u,v) \in X(\vec{G})} \langle \lambda L_1(u^v), L(u^v) \rangle + \sum_{(u,v) \in X(\vec{G})} \langle \mu L_2(u^v), L(u^v) \rangle \\
&= \langle \vec{G}^{\lambda L_1}, \vec{G}^L \rangle + \langle \vec{G}^{\mu L_2}, \vec{G}^L \rangle \\
&= \lambda \langle \vec{G}^{L_1}, \vec{G}^L \rangle + \mu \langle \vec{G}^{L_2}, \vec{G}^L \rangle.
\end{aligned}$$

Thus,  $\vec{G}^\mathcal{V}$  is an inner space also and as the usual, let

$$\|\vec{G}^L\| = \sqrt{\langle \vec{G}^L, \vec{G}^L \rangle}$$

for  $\vec{G}^L \in \vec{G}^\mathcal{V}$ . Then it is a normed space. Furthermore, we know the following result.

**Theorem 2.5** *For any topological graph  $\vec{G}$ ,  $\vec{G}^\mathcal{V}$  is a Banach space, and furthermore, if  $\mathcal{V}$  is a Hilbert space,  $\vec{G}^\mathcal{V}$  is a Hilbert space also.*

*Proof* As shown in the previous,  $\vec{G}^\mathcal{V}$  is a linear normed space or inner space if  $\mathcal{V}$  is an inner space. We show that it is also complete, i.e., any Cauchy sequence in  $\vec{G}^\mathcal{V}$  is converges. In fact, let  $\{\vec{G}^{L_n}\}$  be a Cauchy sequence in  $\vec{G}^\mathcal{V}$ . Thus for any number  $\varepsilon > 0$ , there always exists an integer  $N(\varepsilon)$  such that

$$\|\vec{G}^{L_n} - \vec{G}^{L_m}\| < \varepsilon$$

if  $n, m \geq N(\varepsilon)$ . By definition,

$$\|L_n(u^v) - L_m(u^v)\| \leq \|\vec{G}^{L_n} - \vec{G}^{L_m}\| < \varepsilon$$

i.e.,  $\{L_n(u^v)\}$  is also a Cauchy sequence for  $\forall (u, v) \in X(\vec{G})$ , which is converges on in  $\mathcal{V}$  by definition.

Let  $L(u^v) = \lim_{n \rightarrow \infty} L_n(u^v)$  for  $\forall (u, v) \in X(\vec{G})$ . Then it is clear that

$$\lim_{n \rightarrow \infty} \vec{G}^{L_n} = \vec{G}^L.$$

However, we are needed to show  $\vec{G}^L \in \vec{G}^\mathcal{V}$ . By definition,

$$\sum_{v \in N_G(u)} L_n(u^v) = \mathbf{0}$$

for  $\forall u \in V(\vec{G})$  and integers  $n \geq 1$ . Let  $n \rightarrow \infty$  on its both sides. Then

$$\begin{aligned} \lim_{n \rightarrow \infty} \left( \sum_{v \in N_G(u)} L_n(u^v) \right) &= \sum_{v \in N_G(u)} \lim_{n \rightarrow \infty} L_n(u^v) \\ &= \sum_{v \in N_G(u)} L(u^v) = \mathbf{0}. \end{aligned}$$

Thus,  $\vec{G}^L \in \vec{G}^\mathcal{V}$ . □

Similarly, two conservation  $\vec{G}$ -flows  $\vec{G}^{L_1}$  and  $\vec{G}^{L_2}$  are said to be *orthogonal* if  $\langle \vec{G}^{L_1}, \vec{G}^{L_2} \rangle = 0$ . The following result characterizes those of orthogonal pairs of conservation  $\vec{G}$ -flows.

**Theorem 2.6** *Let  $\vec{G}^{L_1}, \vec{G}^{L_2} \in \vec{G}^\mathcal{V}$ . Then  $\vec{G}^{L_1}$  is orthogonal to  $\vec{G}^{L_2}$  if and only if  $\langle L_1(u^v), L_2(u^v) \rangle = 0$  for  $\forall (u, v) \in X(\vec{G})$ .*

*Proof* Clearly, if  $\langle L_1(u^v), L_2(u^v) \rangle = 0$  for  $\forall (u, v) \in X(\vec{G})$ , then,

$$\langle \vec{G}^{L_1}, \vec{G}^{L_2} \rangle = \sum_{(u,v) \in X(\vec{G})} \langle L_1(u^v), L_2(u^v) \rangle = 0,$$

i.e.,  $\vec{G}^{L_1}$  is orthogonal to  $\vec{G}^{L_2}$ .

Conversely, if  $\vec{G}^{L_1}$  is indeed orthogonal to  $\vec{G}^{L_2}$ , then

$$\langle \vec{G}^{L_1}, \vec{G}^{L_2} \rangle = \sum_{(u,v) \in X(\vec{G})} \langle L_1(u^v), L_2(u^v) \rangle = 0$$

by definition. We therefore know that  $\langle L_1(u^v), L_2(u^v) \rangle = 0$  for  $\forall (u, v) \in X(\vec{G})$  because of  $\langle L_1(u^v), L_2(u^v) \rangle \geq 0$ . □

**Theorem 2.7** *Let  $\mathcal{V}$  be a Hilbert space with an orthogonal decomposition  $\mathcal{V} = \mathbf{V} \oplus \mathbf{V}^\perp$  for a closed subspace  $\mathbf{V} \subset \mathcal{V}$ . Then there is a decomposition*

$$\vec{G}^\mathcal{V} = \tilde{\mathbf{V}} \oplus \tilde{\mathbf{V}}^\perp,$$

where,

$$\begin{aligned} \tilde{\mathbf{V}} &= \left\{ \vec{G}^{L_1} \in \vec{G}^\mathcal{V} \mid L_1 : X(\vec{G}) \rightarrow \mathbf{V} \right\} \\ \tilde{\mathbf{V}}^\perp &= \left\{ \vec{G}^{L_2} \in \vec{G}^\mathcal{V} \mid L_2 : X(\vec{G}) \rightarrow \mathbf{V}^\perp \right\}, \end{aligned}$$

i.e., for  $\forall \vec{G}^L \in \vec{G}^\mathcal{V}$ , there is a uniquely decomposition

$$\vec{G}^L = \vec{G}^{L_1} + \vec{G}^{L_2}$$

with  $L_1 : X(\vec{G}) \rightarrow \mathbf{V}$  and  $L_2 : X(\vec{G}) \rightarrow \mathbf{V}^\perp$ .

*Proof* By definition,  $L(u^v) \in \mathcal{V}$  for  $\forall(u, v) \in X(\vec{G})$ . Thus, there is a decomposition

$$L(u^v) = L_1(u^v) + L_2(u^v)$$

with uniquely determined  $L_1(u^v) \in \mathbf{V}$  but  $L_2(u^v) \in \mathbf{V}^\perp$ .

Let  $[\vec{G}^{L_1}]$  and  $[\vec{G}^{L_2}]$  be two labeled graphs on  $\vec{G}$  with  $L_1 : X_{\frac{1}{2}}(\vec{G}) \rightarrow \mathbf{V}$  and  $L_2 : X_{\frac{1}{2}}(\vec{G}) \rightarrow \mathbf{V}^\perp$ . We need to show that  $[\vec{G}^{L_1}], [\vec{G}^{L_2}] \in \langle \vec{G}, \mathcal{V} \rangle$ . In fact, the conservation laws show that

$$\sum_{v \in N_G(u)} L(u^v) = \mathbf{0}, \quad \text{i.e.,} \quad \sum_{v \in N_G(u)} (L_1(u^v) + L_2(u^v)) = \mathbf{0}$$

for  $\forall u \in V(\vec{G})$ . Consequently,

$$\sum_{v \in N_G(u)} L_1(u^v) + \sum_{v \in N_G(u)} L_2(u^v) = \mathbf{0}.$$

Whence,

$$\begin{aligned} 0 &= \left\langle \sum_{v \in N_G(u)} L_1(u^v) + \sum_{v \in N_G(u)} L_2(u^v), \sum_{v \in N_G(u)} L_1(u^v) + \sum_{v \in N_G(u)} L_2(u^v) \right\rangle \\ &= \left\langle \sum_{v \in N_G(u)} L_1(u^v), \sum_{v \in N_G(u)} L_1(u^v) \right\rangle + \left\langle \sum_{v \in N_G(u)} L_2(u^v), \sum_{v \in N_G(u)} L_2(u^v) \right\rangle \\ &+ \left\langle \sum_{v \in N_G(u)} L_1(u^v), \sum_{v \in N_G(u)} L_2(u^v) \right\rangle + \left\langle \sum_{v \in N_G(u)} L_2(u^v), \sum_{v \in N_G(u)} L_1(u^v) \right\rangle \\ &= \left\langle \sum_{v \in N_G(u)} L_1(u^v), \sum_{v \in N_G(u)} L_1(u^v) \right\rangle + \left\langle \sum_{v \in N_G(u)} L_2(u^v), \sum_{v \in N_G(u)} L_2(u^v) \right\rangle \\ &+ \sum_{v \in N_G(u)} \langle L_1(u^v), L_2(u^v) \rangle + \sum_{v \in N_G(u)} \langle L_2(u^v), L_1(u^v) \rangle \\ &= \left\langle \sum_{v \in N_G(u)} L_1(u^v), \sum_{v \in N_G(u)} L_1(u^v) \right\rangle + \left\langle \sum_{v \in N_G(u)} L_2(u^v), \sum_{v \in N_G(u)} L_2(u^v) \right\rangle. \end{aligned}$$

Notice that

$$\left\langle \sum_{v \in N_G(u)} L_1(u^v), \sum_{v \in N_G(u)} L_1(u^v) \right\rangle \geq 0, \quad \left\langle \sum_{v \in N_G(u)} L_2(u^v), \sum_{v \in N_G(u)} L_2(u^v) \right\rangle \geq 0.$$



We therefore get that

$$\left\langle \sum_{v \in N_G(u)} L_1(u^v), \sum_{v \in N_G(u)} L_1(u^v) \right\rangle = 0, \quad \left\langle \sum_{v \in N_G(u)} L_2(u^v), \sum_{v \in N_G(u)} L_2(u^v) \right\rangle = 0,$$

i.e.,

$$\sum_{v \in N_G(u)} L_1(u^v) = \mathbf{0} \quad \text{and} \quad \sum_{v \in N_G(u)} L_2(u^v) = \mathbf{0}.$$

Thus,  $[\vec{G}^{L_1}], [\vec{G}^{L_2}] \in \vec{G}^\mathcal{V}$ . This completes the proof. □

### 2.3 Solvable $\vec{G}$ -Flow Spaces

Let  $\vec{G}^L$  be a  $\vec{G}$ -flow. If for  $\forall v \in V(\vec{G})$ , all flows  $L(v^u), u \in N_G^+(v) \setminus \{u_0^+\}$  are determined by equations

$$\mathcal{F}_v(L(v^u); L(w^v), w \in N_G^-(v)) = 0$$

unless  $L(v^{u_0})$ , such a  $\vec{G}$ -flow is called *solvable*, and  $L(v^{u_0})$  the *co-flow* at vertex  $v$ . For example, a solvable  $\vec{G}$ -flow is shown in Fig.3.

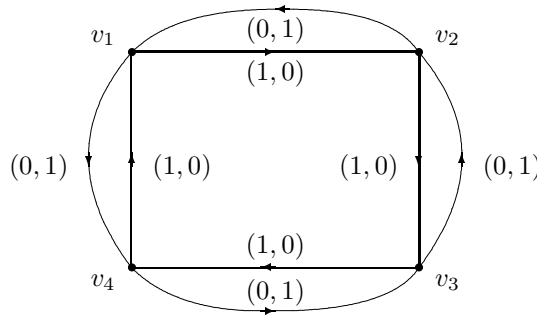

**Fig.3**

A  $\vec{G}$ -flow  $\vec{G}^L$  is *linear* if each  $L(v^{u^+}), u^+ \in N_G^+(v) \setminus \{u_0^+\}$  is determined by

$$L(v^{u^+}) = \sum_{u^- \in N_G^-(v)} a_{u^-} L(u^-v),$$

with scalars  $a_{u^-} \in \mathcal{F}$  for  $\forall v \in V(\vec{G})$  unless  $L(v^{u_0^+})$ , and is *ordinary* or *partial differential* if  $L(v^u)$  is determined by ordinary differential equations

$$L_v \left( \frac{d}{dx_i}; 1 \leq i \leq n \right) \left( L(v^{u^+}); L(u^-v), u^- \in N_G^-(v) \right) = \mathbf{0}$$

or

$$L_v \left( \frac{\partial}{\partial x_i}; 1 \leq i \leq n \right) \left( L(v^{u^+}); L(u^-v), u^- \in N_G^-(v) \right) = \mathbf{0}$$

unless  $L(v^{u_0^+})$  for  $\forall v \in V(\vec{G})$ , where,  $L_v\left(\frac{d}{dx_i}; 1 \leq i \leq n\right)$ ,  $L_v\left(\frac{\partial}{\partial x_i}; 1 \leq i \leq n\right)$  denote an ordinary or partial differential operators, respectively.

Notice that for a strong-connected graph  $\vec{G}$ , there must be a decomposition

$$\vec{G} = \left(\bigcup_{i=1}^{m_1} \vec{C}_i\right) \cup \left(\bigcup_{i=1}^{m_2} \vec{T}_i\right),$$

where  $\vec{C}_i, \vec{T}_j$  are respectively directed circuit or path in  $\vec{G}$  with  $m_1 \geq 1, m_2 \geq 0$ . The following result depends on the structure of  $\vec{G}$ .

**Theorem 2.8** For a strong-connected topological graph  $\vec{G}$  with decomposition

$$\vec{G} = \left(\bigcup_{i=1}^{m_1} \vec{C}_i\right) \cup \left(\bigcup_{i=1}^{m_2} \vec{T}_i\right), \quad m_1 \geq 1, m_2 \geq 0,$$

there always exist linear  $\vec{G}$ -flows  $\vec{G}^L$ , not all flows being zero on  $\vec{G}$ .

*Proof* For an integer  $1 \leq k \leq m_1$ , let  $\vec{C}_k = u_1^k u_2^k \cdots u_{s_k}^k$  and  $L(u_i^{u_{i+1}^k}) = \mathbf{v}_k$ , where  $i+1 \equiv (\text{mod } s_k)$ . Similarly, for integers  $1 \leq j \leq m_2$ , if  $\vec{T}_j = w_1^j w_2^j \cdots w_t^j$ , let  $L(w_j^{w_{j+1}^j}) = \mathbf{0}$ . Clearly, the conservation law hold at  $\forall v \in V(\vec{G})$  by definition, and each flow  $L(u_i^{u_{i+1}^k})$ ,  $i+1 \equiv (\text{mod } s_k)$  is linear determined by

$$\begin{aligned} L(u_i^{u_{i+1}^k}) &= L(u_{i-1}^k u_i^k) + 0 \times \sum_{j \neq i} \sum_{v \in N_{\vec{C}_j}(u_i^k)} L(v^{u_i^k}) + \sum_{j=1}^{m_2} \sum_{v \in N_{\vec{T}_j}(u_i^k)} L(v^{u_i^k}) \\ &= \mathbf{v}_k + \mathbf{0} + \sum_{j=1}^{m_2} \sum_{v \in N_{\vec{T}_j}(u_i^k)} \mathbf{0} = \mathbf{v}_k. \end{aligned}$$

Thus,  $\vec{G}^L$  is a linear solvable  $\vec{G}$ -flow and not all flows being zero on  $\vec{G}$ .  $\square$

All  $\vec{G}$ -flows constructed in Theorem 2.8 can be also replaced by vectors dependent on the time  $t$ , i.e.,  $\mathbf{v}(t)$ . Furthermore, if  $m_1 \geq 2$ , there is at least two circuits  $\vec{C}, \vec{C}'$  in the decomposition of  $\vec{G}$ . Let flows on  $\vec{C}$  and  $\vec{C}'$  be respectively  $\mathbf{x}$  and  $\mathbf{f}(\mathbf{x}, t)$ . We then know the conservation laws hold for vertices in  $\vec{G}$ , and similarly, there are indeed flows on  $\vec{G}$  determined by ordinary differential equations.

**Theorem 2.9** For a strong-connected topological graph  $\vec{G}$  with decomposition

$$\vec{G} = \left(\bigcup_{i=1}^{m_1} \vec{C}_i\right) \cup \left(\bigcup_{i=1}^{m_2} \vec{T}_i\right), \quad m_1 \geq 2, m_2 \geq 0,$$

there always exist ordinary differential  $\vec{G}$ -flows  $\vec{G}^L$ , not all flows being zero on  $\vec{G}$ .

For example, the  $\vec{G}$ -flow shown in Fig.4 is an ordinary differential  $\vec{G}$ -flow in a vector space if  $\dot{\mathbf{x}} = \mathbf{f}(\mathbf{x}, t)$  is solvable with  $\mathbf{x}|_{t=t_0} = \mathbf{x}_0$ .

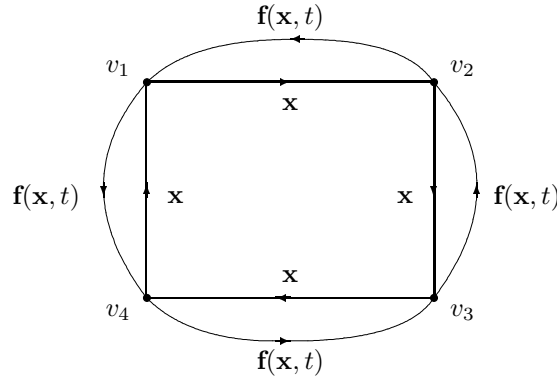

**Fig.4**

Similarly, we know the existence of non-trivial partial differential  $\vec{G}$ -flows. Let  $\mathbf{x} = (x_1, x_2, \dots, x_n)$ . If

$$\begin{cases} x_i = x_i(t, s_1, s_2, \dots, s_{n-1}) \\ u = u(t, s_1, s_2, \dots, s_{n-1}) \\ p_i = p_i(t, s_1, s_2, \dots, s_{n-1}), \quad i = 1, 2, \dots, n \end{cases}$$

is a solution of system

$$\begin{aligned} \frac{dx_1}{F_{p_1}} &= \frac{dx_2}{F_{p_2}} = \dots = \frac{dx_n}{F_{p_n}} = \frac{du}{\sum_{i=1}^n p_i F_{p_i}} \\ &= -\frac{dp_1}{F_{x_1} + p_1 F_u} = \dots = -\frac{dp_n}{F_{x_n} + p_n F_u} = dt \end{aligned}$$

with initial values

$$\begin{cases} x_{i_0} = x_{i_0}(s_1, s_2, \dots, s_{n-1}), \quad u_0 = u_0(s_1, s_2, \dots, s_{n-1}) \\ p_{i_0} = p_{i_0}(s_1, s_2, \dots, s_{n-1}), \quad i = 1, 2, \dots, n \end{cases}$$

such that

$$\begin{cases} F(x_{1_0}, x_{2_0}, \dots, x_{n_0}, u, p_{1_0}, p_{2_0}, \dots, p_{n_0}) = 0 \\ \frac{\partial u_0}{\partial s_j} - \sum_{i=0}^n p_{i_0} \frac{\partial x_{i_0}}{\partial s_j} = 0, \quad j = 1, 2, \dots, n-1, \end{cases}$$

then it is the solution of Cauchy problem

$$\begin{cases} F(x_1, x_2, \dots, x_n, u, p_1, p_2, \dots, p_n) = 0 \\ x_{i_0} = x_{i_0}(s_1, s_2, \dots, s_{n-1}), \quad u_0 = u_0(s_1, s_2, \dots, s_{n-1}) \\ p_{i_0} = p_{i_0}(s_1, s_2, \dots, s_{n-1}), \quad i = 1, 2, \dots, n \end{cases} ,$$

where  $p_i = \frac{\partial u}{\partial x_i}$  and  $F_{p_i} = \frac{\partial F}{\partial p_i}$  for integers  $1 \leq i \leq n$ .

For partial differential equations of second order, the solutions of Cauchy problem on heat or wave equations

$$\begin{cases} \frac{\partial u}{\partial t} = a^2 \sum_{i=1}^n \frac{\partial^2 u}{\partial x_i^2} \\ u|_{t=0} = \varphi(\mathbf{x}) \end{cases} , \quad \begin{cases} \frac{\partial^2 u}{\partial t^2} = a^2 \sum_{i=1}^n \frac{\partial^2 u}{\partial x_i^2} \\ u|_{t=0} = \varphi(\mathbf{x}), \quad \left. \frac{\partial u}{\partial t} \right|_{t=0} = \psi(\mathbf{x}) \end{cases}$$

are respectively known

$$u(\mathbf{x}, t) = \frac{1}{(4\pi t)^{\frac{n}{2}}} \int_{-\infty}^{+\infty} e^{-\frac{(x_1-y_1)^2 + \dots + (x_n-y_n)^2}{4t}} \varphi(y_1, \dots, y_n) dy_1 \cdots dy_n$$

for heat equation and

$$u(x_1, x_2, x_3, t) = \frac{\partial}{\partial t} \left( \frac{1}{4\pi a^2 t} \int_{S_{at}^M} \varphi dS \right) + \frac{1}{4\pi a^2 t} \int_{S_{at}^M} \psi dS$$

for wave equations in  $n = 3$ , where  $S_{at}^M$  denotes the sphere centered at  $M(x_1, x_2, x_3)$  with radius  $at$ . Then, the result following on partial  $\vec{G}$ -flows is similarly known to that of Theorem 2.9.

**Theorem 2.10** For a strong-connected topological graph  $\vec{G}$  with decomposition

$$\vec{G} = \left( \bigcup_{i=1}^{m_1} \vec{C}_i \right) \cup \left( \bigcup_{i=1}^{m_2} \vec{T}_i \right), \quad m_1 \geq 2, \quad m_2 \geq 0,$$

there always exist partial differential  $\vec{G}$ -flows  $\vec{G}^L$ , not all flows being zero on  $\vec{G}$ .

### §3. Operators on $\vec{G}$ -Flow Spaces

#### 3.1 Linear Continuous Operators

**Definition 3.1** Let  $\mathbf{T} \in \mathcal{O}$  be an operator on Banach space  $\mathcal{V}$  over a field  $\mathcal{F}$ . An operator  $\mathbf{T}: \vec{G}^{\mathcal{V}} \rightarrow \vec{G}^{\mathcal{V}}$  is bounded if

$$\|\mathbf{T}(\vec{G}^L)\| \leq \xi \|\vec{G}^L\|$$

for  $\forall \vec{G}^L \in \vec{G}^\mathcal{Y}$  with a constant  $\xi \in [0, \infty)$  and furthermore, is a contractor if

$$\left\| \mathbf{T}(\vec{G}^{L_1}) - \mathbf{T}(\vec{G}^{L_2}) \right\| \leq \xi \left\| \vec{G}^{L_1} - \vec{G}^{L_2} \right\|$$

for  $\forall \vec{G}^{L_1}, \vec{G}^{L_2} \in \vec{G}^\mathcal{Y}$  with  $\xi \in [0, 1)$ .

**Theorem 3.2** Let  $\mathbf{T} : \vec{G}^\mathcal{Y} \rightarrow \vec{G}^\mathcal{Y}$  be a contractor. Then there is a uniquely conservation  $G$ -flow  $\vec{G}^L \in \vec{G}^\mathcal{Y}$  such that

$$\mathbf{T}(\vec{G}^L) = \vec{G}^L.$$

*Proof* Let  $\vec{G}^{L_0} \in \vec{G}^\mathcal{Y}$  be a  $G$ -flow. Define a sequence  $\{\vec{G}^{L_n}\}$  by

$$\begin{aligned} \vec{G}^{L_1} &= \mathbf{T}(\vec{G}^{L_0}), \\ \vec{G}^{L_2} &= \mathbf{T}(\vec{G}^{L_1}) = \mathbf{T}^2(\vec{G}^{L_0}), \\ &\dots\dots\dots, \\ \vec{G}^{L_n} &= \mathbf{T}(\vec{G}^{L_{n-1}}) = \mathbf{T}^n(\vec{G}^{L_0}), \\ &\dots\dots\dots \end{aligned}$$

We prove  $\{\vec{G}^{L_n}\}$  is a Cauchy sequence in  $\vec{G}^\mathcal{Y}$ . Notice that  $\mathbf{T}$  is a contractor. For any integer  $m \geq 1$ , we know that

$$\begin{aligned} \left\| \vec{G}^{L_{m+1}} - \vec{G}^{L_m} \right\| &= \left\| \mathbf{T}(\vec{G}^{L_m}) - \mathbf{T}(\vec{G}^{L_{m-1}}) \right\| \\ &\leq \xi \left\| \vec{G}^{L_m} - \vec{G}^{L_{m-1}} \right\| = \left\| \mathbf{T}(\vec{G}^{L_{m-1}}) - \mathbf{T}(\vec{G}^{L_{m-2}}) \right\| \\ &\leq \xi^2 \left\| \vec{G}^{L_{m-1}} - \vec{G}^{L_{m-2}} \right\| \leq \dots \leq \xi^m \left\| \vec{G}^{L_1} - \vec{G}^{L_0} \right\|. \end{aligned}$$

Applying the triangle inequality, for integers  $m \geq n$  we therefore get that

$$\begin{aligned} &\left\| \vec{G}^{L_m} - \vec{G}^{L_n} \right\| \\ &\leq \left\| \vec{G}^{L_m} - \vec{G}^{L_{m-1}} \right\| + \dots + \left\| \vec{G}^{L_{n-1}} - \vec{G}^{L_n} \right\| \\ &\leq (\xi^m + \xi^{m-1} + \dots + \xi^{n-1}) \times \left\| \vec{G}^{L_1} - \vec{G}^{L_0} \right\| \\ &= \frac{\xi^{n-1} - \xi^m}{1 - \xi} \times \left\| \vec{G}^{L_1} - \vec{G}^{L_0} \right\| \\ &\leq \frac{\xi^{n-1}}{1 - \xi} \times \left\| \vec{G}^{L_1} - \vec{G}^{L_0} \right\| \quad \text{for } 0 < \xi < 1. \end{aligned}$$

Consequently,  $\left\| \vec{G}^{L_m} - \vec{G}^{L_n} \right\| \rightarrow 0$  if  $m \rightarrow \infty, n \rightarrow \infty$ . So the sequence  $\{\vec{G}^{L_n}\}$  is a Cauchy sequence and converges to  $\vec{G}^L$ . Similar to the proof of Theorem 2.5, we know it is a

$G$ -flow, i.e.,  $\vec{G}^L \in \vec{G}^\mathcal{Y}$ . Notice that

$$\begin{aligned} \left\| \vec{G}^L - \mathbf{T}(\vec{G}^L) \right\| &\leq \left\| \vec{G}^L - \vec{G}^{L_m} \right\| + \left\| \vec{G}^{L_m} - \mathbf{T}(\vec{G}^L) \right\| \\ &\leq \left\| \vec{G}^L - \vec{G}^{L_m} \right\| + \xi \left\| \vec{G}^{L_{m-1}} - \vec{G}^L \right\|. \end{aligned}$$

Let  $m \rightarrow \infty$ . For  $0 < \xi < 1$ , we therefore get that  $\left\| \vec{G}^L - \mathbf{T}(\vec{G}^L) \right\| = 0$ , i.e.,  $\mathbf{T}(\vec{G}^L) = \vec{G}^L$ .

For the uniqueness, if there is another conservation  $G$ -flow  $\vec{G}^{L'} \in \vec{G}^\mathcal{Y}$  holding with  $\mathbf{T}(\vec{G}^{L'}) = \vec{G}^L$ , by

$$\left\| \vec{G}^L - \vec{G}^{L'} \right\| = \left\| \mathbf{T}(\vec{G}^L) - \mathbf{T}(\vec{G}^{L'}) \right\| \leq \xi \left\| \vec{G}^L - \vec{G}^{L'} \right\|,$$

it can be only happened in the case of  $\vec{G}^L = \vec{G}^{L'}$  for  $0 < \xi < 1$ .  $\square$

**Definition 3.3** An operator  $\mathbf{T}: \vec{G}^\mathcal{Y} \rightarrow \vec{G}^\mathcal{Y}$  is linear if

$$\mathbf{T}(\lambda \vec{G}^{L_1} + \mu \vec{G}^{L_2}) = \lambda \mathbf{T}(\vec{G}^{L_1}) + \mu \mathbf{T}(\vec{G}^{L_2})$$

for  $\forall \vec{G}^{L_1}, \vec{G}^{L_2} \in \vec{G}^\mathcal{Y}$  and  $\lambda, \mu \in \mathcal{F}$ , and is continuous at a  $\vec{G}$ -flow  $\vec{G}^{L_0}$  if there always exist a number  $\delta(\varepsilon)$  for  $\forall \varepsilon > 0$  such that

$$\left\| \mathbf{T}(\vec{G}^L) - \mathbf{T}(\vec{G}^{L_0}) \right\| < \varepsilon \quad \text{if} \quad \left\| \vec{G}^L - \vec{G}^{L_0} \right\| < \delta(\varepsilon).$$

The following result reveals the relation between conceptions of linear continuous with that of linear bounded.

**Theorem 3.4** An operator  $\mathbf{T}: \vec{G}^\mathcal{Y} \rightarrow \vec{G}^\mathcal{Y}$  is linear continuous if and only if it is bounded.

*Proof* If  $\mathbf{T}$  is bounded, then

$$\left\| \mathbf{T}(\vec{G}^L) - \mathbf{T}(\vec{G}^{L_0}) \right\| = \left\| \mathbf{T}(\vec{G}^L - \vec{G}^{L_0}) \right\| \leq \xi (\vec{G}^L - \vec{G}^{L_0})$$

for an constant  $\xi \in [0, \infty)$  and  $\forall \vec{G}^L, \vec{G}^{L_0} \in \vec{G}^\mathcal{Y}$ . Whence, if

$$\left\| \vec{G}^L - \vec{G}^{L_0} \right\| < \delta(\varepsilon) \quad \text{with} \quad \delta(\varepsilon) = \frac{\varepsilon}{\xi}, \quad \xi \neq 0,$$

then there must be

$$\left\| \mathbf{T}(\vec{G}^L - \vec{G}^{L_0}) \right\| < \varepsilon,$$

i.e.,  $\mathbf{T}$  is linear continuous on  $\vec{G}^\mathcal{Y}$ . However, this is obvious for  $\xi = 0$ .

Now if  $\mathbf{T}$  is linear continuous but unbounded, there exists a sequence  $\{\vec{G}^{L_n}\}$  in  $\vec{G}^\mathcal{Y}$  such

that

$$\|\vec{G}^{L_n}\| \geq n \|\vec{G}^{L_n}\|.$$

Let

$$\vec{G}^{L_n^*} = \frac{1}{n \|\vec{G}^{L_n}\|} \times \vec{G}^{L_n}.$$

Then  $\|\vec{G}^{L_n^*}\| = \frac{1}{n} \rightarrow 0$ , i.e.,  $\|\mathbf{T}(\vec{G}^{L_n^*})\| \rightarrow 0$  if  $n \rightarrow \infty$ . However, by definition

$$\begin{aligned} \|\mathbf{T}(\vec{G}^{L_n^*})\| &= \left\| \mathbf{T} \left( \frac{\vec{G}^{L_n}}{n \|\vec{G}^{L_n}\|} \right) \right\| \\ &= \frac{\|\mathbf{T}(\vec{G}^{L_n})\|}{n \|\vec{G}^{L_n}\|} \geq \frac{n \|\vec{G}^{L_n}\|}{n \|\vec{G}^{L_n}\|} = 1, \end{aligned}$$

a contradiction. Thus,  $\mathbf{T}$  must be bounded.  $\square$

The following result is a generalization of the representation theorem of Fréchet and Riesz on linear continuous functionals, i.e.,  $\mathbf{T} : \vec{G}^{\mathcal{Y}} \rightarrow \mathbb{C}$  on  $\vec{G}$ -flow space  $\vec{G}^{\mathcal{Y}}$ , where  $\mathbb{C}$  is the complex field.

**Theorem 3.5** *Let  $\mathbf{T} : \vec{G}^{\mathcal{Y}} \rightarrow \mathbb{C}$  be a linear continuous functional. Then there is a unique  $\vec{G}^{\hat{L}} \in \vec{G}^{\mathcal{Y}}$  such that*

$$\mathbf{T}(\vec{G}^L) = \langle \vec{G}^L, \vec{G}^{\hat{L}} \rangle$$

for  $\forall \vec{G}^L \in \vec{G}^{\mathcal{Y}}$ .

*Proof* Define a closed subset of  $\vec{G}^{\mathcal{Y}}$  by

$$\mathcal{N}(\mathbf{T}) = \left\{ \vec{G}^L \in \vec{G}^{\mathcal{Y}} \mid \mathbf{T}(\vec{G}^L) = 0 \right\}$$

for the linear continuous functional  $\mathbf{T}$ . If  $\mathcal{N}(\mathbf{T}) = \vec{G}^{\mathcal{Y}}$ , i.e.,  $\mathbf{T}(\vec{G}^L) = 0$  for  $\forall \vec{G}^L \in \vec{G}^{\mathcal{Y}}$ , choose  $\vec{G}^{\hat{L}} = \mathbf{O}$ . We then easily obtain the identity

$$\mathbf{T}(\vec{G}^L) = \langle \vec{G}^L, \vec{G}^{\hat{L}} \rangle.$$

Whence, we assume that  $\mathcal{N}(\mathbf{T}) \neq \vec{G}^{\mathcal{Y}}$ . In this case, there is an orthogonal decomposition

$$\vec{G}^{\mathcal{Y}} = \mathcal{N}(\mathbf{T}) \oplus \mathcal{N}^\perp(\mathbf{T})$$

with  $\mathcal{N}(\mathbf{T}) \neq \{\mathbf{O}\}$  and  $\mathcal{N}^\perp(\mathbf{T}) \neq \{\mathbf{O}\}$ .

Choose a  $\vec{G}$ -flow  $\vec{G}^{L_0} \in \mathcal{N}^\perp(\mathbf{T})$  with  $\vec{G}^{L_0} \neq \mathbf{O}$  and define

$$\vec{G}^{L^*} = \left( \mathbf{T}(\vec{G}^L) \right) \vec{G}^{L_0} - \left( \mathbf{T}(\vec{G}^{L_0}) \right) \vec{G}^L$$

for  $\forall \vec{G}^L \in \vec{G}^{\mathcal{V}}$ . Calculation shows that

$$\mathbf{T}(\vec{G}^{L*}) = (\mathbf{T}(\vec{G}^L)) \mathbf{T}(\vec{G}^{L_0}) - (\mathbf{T}(\vec{G}^{L_0})) \mathbf{T}(\vec{G}^L) = 0,$$

i.e.,  $\vec{G}^{L*} \in \mathcal{N}(\mathbf{T})$ . We therefore get that

$$\begin{aligned} 0 &= \langle \vec{G}^{L*}, \vec{G}^{L_0} \rangle \\ &= \langle (\mathbf{T}(\vec{G}^L)) \vec{G}^{L_0} - (\mathbf{T}(\vec{G}^{L_0})) \vec{G}^L, \vec{G}^{L_0} \rangle \\ &= \mathbf{T}(\vec{G}^L) \langle \vec{G}^{L_0}, \vec{G}^{L_0} \rangle - \mathbf{T}(\vec{G}^{L_0}) \langle \vec{G}^L, \vec{G}^{L_0} \rangle. \end{aligned}$$

Notice that  $\langle \vec{G}^{L_0}, \vec{G}^{L_0} \rangle = \|\vec{G}^{L_0}\|^2 \neq 0$ . We find that

$$\mathbf{T}(\vec{G}^L) = \frac{\mathbf{T}(\vec{G}^{L_0})}{\|\vec{G}^{L_0}\|^2} \langle \vec{G}^L, \vec{G}^{L_0} \rangle = \left\langle \vec{G}^L, \frac{\overline{\mathbf{T}(\vec{G}^{L_0})}}{\|\vec{G}^{L_0}\|^2} \vec{G}^{L_0} \right\rangle.$$

Let

$$\vec{G}^{\hat{L}} = \frac{\overline{\mathbf{T}(\vec{G}^{L_0})}}{\|\vec{G}^{L_0}\|^2} \vec{G}^{L_0} = \vec{G}^{\lambda L_0},$$

where  $\lambda = \frac{\overline{\mathbf{T}(\vec{G}^{L_0})}}{\|\vec{G}^{L_0}\|^2}$ . We consequently get that  $\mathbf{T}(\vec{G}^L) = \langle \vec{G}^L, \vec{G}^{\hat{L}} \rangle$ .

Now if there is another  $\vec{G}^{\hat{L}'} \in \vec{G}^{\mathcal{V}}$  such that  $\mathbf{T}(\vec{G}^L) = \langle \vec{G}^L, \vec{G}^{\hat{L}'} \rangle$  for  $\forall \vec{G}^L \in \vec{G}^{\mathcal{V}}$ , there must be  $\langle \vec{G}^L, \vec{G}^{\hat{L}} - \vec{G}^{\hat{L}'} \rangle = 0$  by definition. Particularly, let  $\vec{G}^L = \vec{G}^{\hat{L}} - \vec{G}^{\hat{L}'}$ . We know that

$$\|\vec{G}^{\hat{L}} - \vec{G}^{\hat{L}'}\| = \langle \vec{G}^{\hat{L}} - \vec{G}^{\hat{L}'}, \vec{G}^{\hat{L}} - \vec{G}^{\hat{L}'} \rangle = 0,$$

which implies that  $\vec{G}^{\hat{L}} - \vec{G}^{\hat{L}'} = \mathbf{0}$ , i.e.,  $\vec{G}^{\hat{L}} = \vec{G}^{\hat{L}'}$ .  $\square$

### 3.2 Differential and Integral Operators

Let  $\mathcal{V}$  be Hilbert space consisting of measurable functions  $f(x_1, x_2, \dots, x_n)$  on a set

$$\Delta = \{\mathbf{x} = (x_1, x_2, \dots, x_n) \in \mathbb{R}^n \mid a_i \leq x_i \leq b_i, 1 \leq i \leq n\},$$

i.e., the functional space  $L^2[\Delta]$ , with inner product

$$\langle f(\mathbf{x}), g(\mathbf{x}) \rangle = \int_{\Delta} \overline{f(\mathbf{x})} g(\mathbf{x}) d\mathbf{x} \quad \text{for } f(\mathbf{x}), g(\mathbf{x}) \in L^2[\Delta]$$

and  $\vec{G}^{\mathcal{V}}$  its  $\vec{G}$ -extension on a topological graph  $\vec{G}$ . The *differential operator* and *integral*



operators

$$D = \sum_{i=1}^n a_i \frac{\partial}{\partial x_i} \quad \text{and} \quad \int_{\Delta}, \quad \overline{\int}_{\Delta}$$

on  $\overrightarrow{G}^{\mathcal{V}}$  are respectively defined by

$$D\overrightarrow{G}^L = \overrightarrow{G}^{DL(u^v)}$$

and

$$\begin{aligned} \int_{\Delta} \overrightarrow{G}^L &= \int_{\Delta} K(\mathbf{x}, \mathbf{y}) \overrightarrow{G}^{L[\mathbf{y}]} d\mathbf{y} = \overrightarrow{G}^{\int_{\Delta} K(\mathbf{x}, \mathbf{y}) L(u^v)[\mathbf{y}] d\mathbf{y}}, \\ \overline{\int}_{\Delta} \overrightarrow{G}^L &= \int_{\Delta} \overline{K(\mathbf{x}, \mathbf{y})} \overrightarrow{G}^{L[\mathbf{y}]} d\mathbf{y} = \overrightarrow{G}^{\int_{\Delta} \overline{K(\mathbf{x}, \mathbf{y})} L(u^v)[\mathbf{y}] d\mathbf{y}} \end{aligned}$$

for  $\forall(u, v) \in X(\overrightarrow{G})$ , where  $a_i, \frac{\partial a_i}{\partial x_j} \in \mathbb{C}^0(\Delta)$  for integers  $1 \leq i, j \leq n$  and  $K(\mathbf{x}, \mathbf{y}) : \Delta \times \Delta \rightarrow \mathbb{C} \in L^2(\Delta \times \Delta, \mathbb{C})$  with

$$\int_{\Delta \times \Delta} K(\mathbf{x}, \mathbf{y}) d\mathbf{x} d\mathbf{y} < \infty.$$

Such integral operators are usually called adjoint for  $\overline{\overline{\int}}_{\Delta} = \int_{\Delta}$  by  $\overline{\overline{K(\mathbf{x}, \mathbf{y})}} = K(\mathbf{x}, \mathbf{y})$ .

Clearly, for  $\overrightarrow{G}^{L_1}, \overrightarrow{G}^{L_2} \in \overrightarrow{G}^{\mathcal{V}}$  and  $\lambda, \mu \in \mathcal{F}$ ,

$$\begin{aligned} D\left(\lambda \overrightarrow{G}^{L_1(u^v)} + \mu \overrightarrow{G}^{L_2(u^v)}\right) &= D\left(\overrightarrow{G}^{\lambda L_1(u^v) + \mu L_2(u^v)}\right) = \overrightarrow{G}^{D(\lambda L_1(u^v) + \mu L_2(u^v))} \\ &= \overrightarrow{G}^{D(\lambda L_1(u^v)) + D(\mu L_2(u^v))} = \overrightarrow{G}^{D(\lambda L_1(u^v))} + \overrightarrow{G}^{D(\mu L_2(u^v))} \\ &= D\left(\overrightarrow{G}^{(\lambda L_1(u^v))} + \overrightarrow{G}^{(\mu L_2(u^v))}\right) = \lambda D\left(\overrightarrow{G}^{L_1(u^v)}\right) + D\left(\mu \overrightarrow{G}^{L_2(u^v)}\right) \end{aligned}$$

for  $\forall(u, v) \in X(\overrightarrow{G})$ , i.e.,

$$D\left(\lambda \overrightarrow{G}^{L_1} + \mu \overrightarrow{G}^{L_2}\right) = \lambda D\overrightarrow{G}^{L_1} + \mu D\overrightarrow{G}^{L_2}.$$

Similarly, we know also that

$$\begin{aligned} \int_{\Delta} \left(\lambda \overrightarrow{G}^{L_1} + \mu \overrightarrow{G}^{L_2}\right) &= \lambda \int_{\Delta} \overrightarrow{G}^{L_1} + \mu \int_{\Delta} \overrightarrow{G}^{L_2}, \\ \overline{\int}_{\Delta} \left(\lambda \overrightarrow{G}^{L_1} + \mu \overrightarrow{G}^{L_2}\right) &= \lambda \overline{\int}_{\Delta} \overrightarrow{G}^{L_1} + \mu \overline{\int}_{\Delta} \overrightarrow{G}^{L_2}. \end{aligned}$$

Thus, operators  $D, \int_{\Delta}$  and  $\overline{\int}_{\Delta}$  are all linear on  $\overrightarrow{G}^{\mathcal{V}}$ .

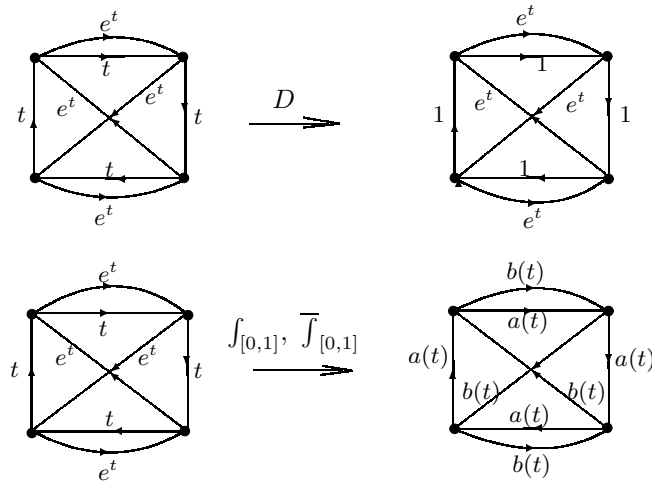

Fig.5

For example, let  $f(t) = t$ ,  $g(t) = e^t$ ,  $K(t, \tau) = t^2 + \tau^2$  for  $\Delta = [0, 1]$  and let  $\vec{G}^L$  be the  $\vec{G}$ -flow shown on the left in Fig.6. Then, we know that  $Df = 1, Dg = e^t$ ,

$$\int_0^1 K(t, \tau)f(\tau)d\tau = \int_0^1 \overline{K(t, \tau)}f(\tau)d\tau = \int_0^1 (t^2 + \tau^2) \tau d\tau = \frac{t^2}{2} + \frac{1}{4} = a(t),$$

$$\int_0^1 K(t, \tau)g(\tau)d\tau = \int_0^1 \overline{K(t, \tau)}g(\tau)d\tau = \int_0^1 (t^2 + \tau^2) e^\tau d\tau = (e - 1)t^2 + e - 2 = b(t)$$

and the actions  $D\vec{G}^L, \int_{[0,1]} \vec{G}^L$  and  $\overline{\int_{[0,1]} \vec{G}^L}$  are shown on the right in Fig.5.

Furthermore, we know that both of them are injections on  $\vec{G}^\mathcal{V}$ .

**Theorem 3.6**  $D : \vec{G}^\mathcal{V} \rightarrow \vec{G}^\mathcal{V}$  and  $\int_\Delta : \vec{G}^\mathcal{V} \rightarrow \vec{G}^\mathcal{V}$ .

*Proof* For  $\forall \vec{G}^L \in \vec{G}^\mathcal{V}$ , we are needed to show that  $D\vec{G}^L$  and  $\int_\Delta \vec{G}^L \in \vec{G}^\mathcal{V}$ , i.e., the conservation laws

$$\sum_{v \in N_G(u)} DL(u^v) = \mathbf{0} \quad \text{and} \quad \sum_{v \in N_G(u)} \int_\Delta L(u^v) = \mathbf{0}$$

hold with  $\forall v \in V(\vec{G})$ .

However, because of  $\vec{G}^{L(u^v)} \in \vec{G}^\mathcal{V}$ , there must be

$$\sum_{v \in N_G(u)} L(u^v) = \mathbf{0} \quad \text{for} \quad \forall v \in V(\vec{G}),$$

we immediately know that

$$\mathbf{0} = D \left( \sum_{v \in N_G(u)} L(u^v) \right) = \sum_{v \in N_G(u)} DL(u^v)$$

and

$$\mathbf{0} = \int_{\Delta} \left( \sum_{v \in N_G(u)} L(u^v) \right) = \sum_{v \in N_G(u)} \int_{\Delta} L(u^v)$$

for  $\forall v \in V(\vec{G})$ . □

#### §4. $\vec{G}$ -Flow Solutions of Equations

As we mentioned, all  $G$ -solutions of non-solvable systems on algebraic, ordinary or partial differential equations determined in [13]-[19] are in fact  $\vec{G}$ -flows. We show there are also  $\vec{G}$ -flow solutions for solvable equations, which implies that the  $\vec{G}$ -flow solutions are fundamental for equations.

##### 4.1 Linear Equations

Let  $\mathcal{V}$  be a field  $(\mathcal{F}; +, \cdot)$ . We can further define

$$\vec{G}^{L_1} \circ \vec{G}^{L_2} = \vec{G}^{L_1 \cdot L_2}$$

with  $L_1 \cdot L_2(u^v) = L_1(u^v) \cdot L_2(u^v)$  for  $\forall(u, v) \in X(\vec{G})$ . Then it can be verified easily that  $\vec{G}^{\mathcal{F}}$  is also a field  $(\vec{G}^{\mathcal{F}}; +, \circ)$  with a subfield  $\widehat{\mathcal{F}}$  isomorphic to  $\mathcal{F}$  if the conservation laws is not emphasized, where

$$\widehat{\mathcal{F}} = \left\{ \vec{G}^L \in \vec{G}^{\mathcal{F}} \mid L(u^v) \text{ is constant in } \mathcal{F} \text{ for } \forall(u, v) \in X(\vec{G}) \right\}.$$

Clearly,  $\vec{G}^{\mathcal{F}} \simeq \mathcal{F}^{|E(\vec{G})|}$ . Thus  $|\vec{G}^{\mathcal{F}}| = p^n |E(\vec{G})|$  if  $|\mathcal{F}| = p^n$ , where  $p$  is a prime number. For this  $\mathcal{F}$ -extension on  $\vec{G}$ , the linear equation

$$aX = \vec{G}^L$$

is uniquely solvable for  $X = \vec{G}^{a^{-1}L}$  in  $\vec{G}^{\mathcal{F}}$  if  $0 \neq a \in \mathcal{F}$ . Particularly, if one views an element  $b \in \mathcal{F}$  as  $b = \vec{G}^L$  if  $L(u^v) = b$  for  $(u, v) \in X(\vec{G})$  and  $0 \neq a \in \mathcal{F}$ , then an algebraic equation

$$ax = b$$

in  $\mathcal{F}$  also is an equation in  $\vec{G}^{\mathcal{F}}$  with a solution  $x = \vec{G}^{a^{-1}L}$  such as those shown in Fig.6 for  $\vec{G} = \vec{C}_4$ ,  $a = 3$ ,  $b = 5$  following.

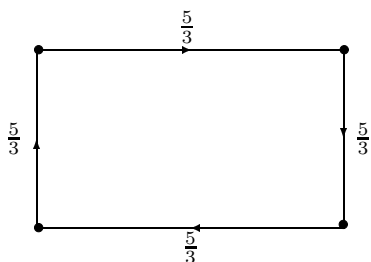

Fig.6

Let  $[L_{ij}]_{m \times n}$  be a matrix with entries  $L_{ij} : \mathcal{U} \rightarrow \mathcal{V}$ . Denoted by  $[L_{ij}]_{m \times n}(u^v)$  the matrix  $[L_{ij}(u^v)]_{m \times n}$ . Then, a general result on  $\vec{G}$ -flow solutions of linear systems is known following.

**Theorem 4.1** *A linear system  $(LES_m^n)$  of equations*

$$\begin{cases} a_{11}X_1 + a_{12}X_2 + \cdots + a_{1n}X_n = \vec{G}^{L_1} \\ a_{21}X_1 + a_{22}X_2 + \cdots + a_{2n}X_n = \vec{G}^{L_2} \\ \dots\dots\dots \\ a_{m1}X_1 + a_{m2}X_2 + \cdots + a_{mn}X_n = \vec{G}^{L_m} \end{cases} \quad (LES_m^n)$$

with  $a_{ij} \in \mathbb{C}$  and  $\vec{G}^{L_i} \in \vec{G}^{\mathcal{V}}$  for integers  $1 \leq i \leq n$  and  $1 \leq j \leq m$  is solvable for  $X_i \in \vec{G}^{\mathcal{U}}, 1 \leq i \leq m$  if and only if

$$\text{rank} [a_{ij}]_{m \times n} = \text{rank} [a_{ij}]_{m \times (n+1)}^+(u^v)$$

for  $\forall(u, v) \in \vec{G}$ , where

$$[a_{ij}]_{m \times (n+1)}^+ = \begin{bmatrix} a_{11} & a_{12} & \cdots & a_{1n} & L_1 \\ a_{21} & a_{22} & \cdots & a_{2n} & L_2 \\ \dots & \dots & \dots & \dots & \dots \\ a_{m1} & a_{m2} & \cdots & a_{mn} & L_m \end{bmatrix}.$$

*Proof* Let  $X_i = \vec{G}^{L_{x_i}}$  with  $L_{x_i}(u^v) \in \mathcal{V}$  on  $(u, v) \in X(\vec{G})$  for integers  $1 \leq i \leq n$ . For  $\forall(u, v) \in X(\vec{G})$ , the system  $(LES_m^n)$  appears as a common linear system

$$\begin{cases} a_{11}L_{x_1}(u^v) + a_{12}L_{x_2}(u^v) + \cdots + a_{1n}L_{x_n}(u^v) = L_1(u^v) \\ a_{21}L_{x_1}(u^v) + a_{22}L_{x_2}(u^v) + \cdots + a_{2n}L_{x_n}(u^v) = L_2(u^v) \\ \dots\dots\dots \\ a_{m1}L_{x_1}(u^v) + a_{m2}L_{x_2}(u^v) + \cdots + a_{mn}L_{x_n}(u^v) = L_m(u^v) \end{cases}$$

By linear algebra, such a system is solvable if and only if ([4])

$$\text{rank} [a_{ij}]_{m \times n} = \text{rank} [a_{ij}]_{m \times (n+1)}^+ (u^v)$$

for  $\forall (u, v) \in \vec{G}$ .

Labeling the semi-arc  $u^v$  respectively by solutions  $L_{x_1}(u^v), L_{x_2}(u^v), \dots, L_{x_n}(u^v)$  for  $\forall (u, v) \in X(\vec{G})$ , we get labeled graphs  $\vec{G}^{L_{x_1}}, \vec{G}^{L_{x_2}}, \dots, \vec{G}^{L_{x_n}}$ . We prove that  $\vec{G}^{L_{x_1}}, \vec{G}^{L_{x_2}}, \dots, \vec{G}^{L_{x_n}} \in \vec{G}^\psi$ .

Let  $\text{rank} [a_{ij}]_{m \times n} = r$ . Similar to that of linear algebra, we are easily know that

$$\left\{ \begin{aligned} X_{j_1} &= \sum_{i=1}^m c_{1i} \vec{G}^{L_i} + c_{1,r+1} X_{j_{r+1}} + \dots + c_{1n} X_{j_n} \\ X_{j_2} &= \sum_{i=1}^m c_{2i} \vec{G}^{L_i} + c_{2,r+1} X_{j_{r+1}} + \dots + c_{2n} X_{j_n} \\ \dots &\dots \dots \dots \dots \dots \dots \dots \dots \dots \dots \dots \dots \dots \\ X_{j_r} &= \sum_{i=1}^m c_{ri} \vec{G}^{L_i} + c_{r,r+1} X_{j_{r+1}} + \dots + c_{rn} X_{j_n} \end{aligned} \right. ,$$

where  $\{j_1, \dots, j_n\} = \{1, \dots, n\}$ . Whence, if  $\vec{G}^{L_{x_{j_{r+1}}}}, \dots, \vec{G}^{L_{x_{j_n}}} \in \vec{G}^\psi$ , then

$$\begin{aligned} \sum_{v \in N_G(u)} L_{x_k}(u^v) &= \sum_{v \in N_G(u)} \sum_{i=1}^m c_{ki} L_i(u^v) \\ &\quad + \sum_{v \in N_G(u)} c_{2,r+1} L_{x_{j_{r+1}}}(u^v) + \dots + \sum_{v \in N_G(u)} c_{2n} L_{x_{j_n}}(u^v) \\ &= \sum_{i=1}^m c_{ki} \left( \sum_{v \in N_G(u)} L_i(u^v) \right) \\ &\quad + c_{2,r+1} \sum_{v \in N_G(u)} L_{x_{j_{r+1}}}(u^v) + \dots + c_{2n} \sum_{v \in N_G(u)} L_{x_{j_n}}(u^v) = \mathbf{0} \end{aligned}$$

Whence, the system  $(LES_m^n)$  is solvable in  $\vec{G}^\psi$ . □

The following result is an immediate conclusion of Theorem 4.1.

**Corollary 4.2** *A linear system of equations*

$$\left\{ \begin{aligned} a_{11}x_1 + a_{12}x_2 + \dots + a_{1n}x_n &= b_1 \\ a_{21}x_1 + a_{22}x_2 + \dots + a_{2n}x_n &= b_2 \\ \dots &\dots \dots \dots \dots \dots \dots \dots \\ a_{m1}x_1 + a_{m2}x_2 + \dots + a_{mn}x_n &= b_m \end{aligned} \right.$$

with  $a_{ij}, b_j \in \mathcal{F}$  for integers  $1 \leq i \leq n, 1 \leq j \leq m$  holding with

$$\text{rank} [a_{ij}]_{m \times n} = \text{rank} [a_{ij}]_{m \times (n+1)}^+$$

has  $\overrightarrow{G}$ -flow solutions on infinitely many topological graphs  $\overrightarrow{G}$ .

Let the operator  $D$  and  $\Delta \subset \mathbb{R}^n$  be the same as in Subsection 3.2. We consider differential equations in  $\overrightarrow{G}^\mathcal{V}$  following.

**Theorem 4.3** For  $\forall G^L \in \overrightarrow{G}^\mathcal{V}$ , the Cauchy problem on differential equation

$$DG^X = G^L$$

is uniquely solvable prescribed with  $\overrightarrow{G}^{X|_{x_n=x_n^0}} = \overrightarrow{G}^{L_0}$ .

*Proof* For  $\forall(u, v) \in X(\overrightarrow{G})$ , denoted by  $F(u^v)$  the flow on the semi-arc  $u^v$ . Then the differential equation  $DG^X = G^L$  transforms into a linear partial differential equation

$$\sum_{i=1}^n a_i \frac{\partial F(u^v)}{\partial x_i} = L(u^v)$$

on the semi-arc  $u^v$ . By assumption,  $a_i \in \mathbb{C}^0(\Delta)$  and  $L(u^v) \in L^2[\Delta]$ , which implies that there is a uniquely solution  $F(u^v)$  with initial value  $L_0(u^v)$  by the characteristic theory of partial differential equation of first order. In fact, let  $\phi_i(x_1, x_2, \dots, x_n, F)$ ,  $1 \leq i \leq n$  be the  $n$  independent first integrals of its characteristic equations. Then

$$F(u^v) = F'(u^v) - L_0(x'_1, x'_2 \dots, x'_{n-1}) \in L^2[\Delta],$$

where,  $x'_1, x'_2, \dots, x'_{n-1}$  and  $F'$  are determined by system of equations

$$\left\{ \begin{array}{l} \phi_1(x_1, x_2, \dots, x_{n-1}, x_n^0, F) = \overline{\phi}_1 \\ \phi_2(x_1, x_2, \dots, x_{n-1}, x_n^0, F) = \overline{\phi}_2 \\ \dots\dots\dots \\ \phi_n(x_1, x_2, \dots, x_{n-1}, x_n^0, F) = \overline{\phi}_n \end{array} \right.$$

Clearly,

$$D\left(\sum_{v \in N_G(u)} F(u^v)\right) = \sum_{v \in N_G(u)} DF(u^v) = \sum_{v \in N_G(u)} L(u^v) = \mathbf{0}.$$

Notice that

$$\sum_{v \in N_G(u)} F(u^v) \bigg|_{x_n=x_n^0} = \sum_{v \in N_G(u)} L_0(u^v) = \mathbf{0}.$$

We therefore know that

$$\sum_{v \in N_G(u)} F(u^v) = \mathbf{0}.$$

Thus, we get a uniquely solution  $\vec{G}^X = \vec{G}^F \in \vec{G}^\mathcal{V}$  for the equation

$$DG^X = G^L$$

prescribed with initial data  $\vec{G}^X|_{x_n=x_n^0} = \vec{G}^{L_0}$ .  $\square$

We know that the Cauchy problem on heat equation

$$\frac{\partial u}{\partial t} = c^2 \sum_{i=1}^n \frac{\partial^2 u}{\partial x_i^2}$$

is solvable in  $\mathbb{R}^n \times \mathbb{R}$  if  $u(\mathbf{x}, t_0) = \varphi(\mathbf{x})$  is continuous and bounded in  $\mathbb{R}^n$ ,  $c$  a non-zero constant in  $\mathbb{R}$ . For  $\vec{G}^L \in \vec{G}^\mathcal{V}$  in Subsection 3.2, if we define

$$\frac{\partial \vec{G}^L}{\partial t} = \vec{G}^{\frac{\partial L}{\partial t}} \quad \text{and} \quad \frac{\partial \vec{G}^L}{\partial x_i} = \vec{G}^{\frac{\partial L}{\partial x_i}}, \quad 1 \leq i \leq n,$$

then we can also consider the Cauchy problem in  $\vec{G}^\mathcal{V}$ , i.e.,

$$\frac{\partial X}{\partial t} = c^2 \sum_{i=1}^n \frac{\partial^2 X}{\partial x_i^2}$$

with initial values  $X|_{t=t_0}$ , and know the result following.

**Theorem 4.4** For  $\forall \vec{G}^{L'} \in \vec{G}^\mathcal{V}$  and a non-zero constant  $c$  in  $\mathbb{R}$ , the Cauchy problems on differential equations

$$\frac{\partial X}{\partial t} = c^2 \sum_{i=1}^n \frac{\partial^2 X}{\partial x_i^2}$$

with initial value  $X|_{t=t_0} = \vec{G}^{L'} \in \vec{G}^\mathcal{V}$  is solvable in  $\vec{G}^\mathcal{V}$  if  $L'(u^v)$  is continuous and bounded in  $\mathbb{R}^n$  for  $\forall (u, v) \in X(\vec{G})$ .

*Proof* For  $(u, v) \in X(\vec{G})$ , the Cauchy problem on the semi-arc  $u^v$  appears as

$$\frac{\partial u}{\partial t} = c^2 \sum_{i=1}^n \frac{\partial^2 u}{\partial x_i^2}$$

with initial value  $u|_{t=0} = L'(u^v)(\mathbf{x})$  if  $X = \vec{G}^F$ . According to the theory of partial differential equations, we know that

$$F(u^v)(\mathbf{x}, t) = \frac{1}{(4\pi t)^{\frac{n}{2}}} \int_{-\infty}^{+\infty} e^{-\frac{(x_1-y_1)^2 + \dots + (x_n-y_n)^2}{4t}} L'(u^v)(y_1, \dots, y_n) dy_1 \cdots dy_n.$$

Labeling the semi-arc  $u^v$  by  $F(u^v)(\mathbf{x}, t)$  for  $\forall (u, v) \in X(\vec{G})$ , we get a labeled graph  $\vec{G}^F$  on  $\vec{G}$ . We prove  $\vec{G}^F \in \vec{G}^\mathcal{V}$ .

By assumption,  $\vec{G}^{L'} \in \vec{G}^{\mathcal{Y}}$ , i.e., for  $\forall u \in V(\vec{G})$ ,

$$\sum_{v \in N_G(u)} L'(u^v)(\mathbf{x}) = \mathbf{0},$$

we know that

$$\begin{aligned} & \sum_{v \in N_G(u)} F(u^v)(\mathbf{x}, t) \\ &= \sum_{v \in N_G(u)} \frac{1}{(4\pi t)^{\frac{n}{2}}} \int_{-\infty}^{+\infty} e^{-\frac{(x_1-y_1)^2+\dots+(x_n-y_n)^2}{4t}} L'(u^v)(y_1, \dots, y_n) dy_1 \cdots dy_n \\ &= \frac{1}{(4\pi t)^{\frac{n}{2}}} \int_{-\infty}^{+\infty} e^{-\frac{(x_1-y_1)^2+\dots+(x_n-y_n)^2}{4t}} \left( \sum_{v \in N_G(u)} L'(u^v)(y_1, \dots, y_n) \right) dy_1 \cdots dy_n \\ &= \frac{1}{(4\pi t)^{\frac{n}{2}}} \int_{-\infty}^{+\infty} e^{-\frac{(x_1-y_1)^2+\dots+(x_n-y_n)^2}{4t}} (\mathbf{0}) dy_1 \cdots dy_n = \mathbf{0} \end{aligned}$$

for  $\forall u \in V(\vec{G})$ . Therefore,  $\vec{G}^F \in \vec{G}^{\mathcal{Y}}$  and

$$\frac{\partial X}{\partial t} = c^2 \sum_{i=1}^n \frac{\partial^2 X}{\partial x_i^2}$$

with initial value  $X|_{t=t_0} = \vec{G}^{L'} \in \vec{G}^{\mathcal{Y}}$  is solvable in  $\vec{G}^{\mathcal{Y}}$ .  $\square$

Similarly, we can also get a result on Cauchy problem on 3-dimensional wave equation in  $\vec{G}^{\mathcal{Y}}$  following.

**Theorem 4.5** For  $\forall \vec{G}^{L'} \in \vec{G}^{\mathcal{Y}}$  and a non-zero constant  $c$  in  $\mathbb{R}$ , the Cauchy problems on differential equations

$$\frac{\partial^2 X}{\partial t^2} = c^2 \left( \frac{\partial^2 X}{\partial x_1^2} + \frac{\partial^2 X}{\partial x_2^2} + \frac{\partial^2 X}{\partial x_3^2} \right)$$

with initial value  $X|_{t=t_0} = \vec{G}^{L'} \in \vec{G}^{\mathcal{Y}}$  is solvable in  $\vec{G}^{\mathcal{Y}}$  if  $L'(u^v)$  is continuous and bounded in  $\mathbb{R}^n$  for  $\forall(u, v) \in X(\vec{G})$ .

For an integral kernel  $K(\mathbf{x}, \mathbf{y})$ , the two subspaces  $\mathcal{N}, \mathcal{N}^* \subset L^2[\Delta]$  are determined by

$$\begin{aligned} \mathcal{N} &= \left\{ \phi(\mathbf{x}) \in L^2[\Delta] \mid \int_{\Delta} K(\mathbf{x}, \mathbf{y}) \phi(\mathbf{y}) d\mathbf{y} = \phi(\mathbf{x}) \right\}, \\ \mathcal{N}^* &= \left\{ \varphi(\mathbf{x}) \in L^2[\Delta] \mid \int_{\Delta} \overline{K(\mathbf{x}, \mathbf{y})} \varphi(\mathbf{y}) d\mathbf{y} = \varphi(\mathbf{x}) \right\}. \end{aligned}$$

Then we know the result following.



**Theorem 4.6** For  $\forall G^L \in \vec{G}^{\mathcal{V}}$ , if  $\dim \mathcal{N} = 0$ , then the integral equation

$$\vec{G}^X - \int_{\Delta} \vec{G}^X = G^L$$

is solvable in  $\vec{G}^{\mathcal{V}}$  with  $\mathcal{V} = L^2[\Delta]$  if and only if

$$\langle \vec{G}^L, \vec{G}^{L'} \rangle = 0, \quad \forall \vec{G}^{L'} \in \mathcal{N}^*.$$

*Proof* For  $\forall (u, v) \in X(\vec{G})$

$$\vec{G}^X - \int_{\Delta} \vec{G}^X = G^L \quad \text{and} \quad \langle \vec{G}^L, \vec{G}^{L'} \rangle = 0, \quad \forall \vec{G}^{L'} \in \mathcal{N}^*$$

on the semi-arc  $u^v$  respectively appear as

$$F(\mathbf{x}) - \int_{\Delta} K(\mathbf{x}, \mathbf{y}) F(\mathbf{y}) d\mathbf{y} = L(u^v)[\mathbf{x}]$$

if  $X(u^v) = F(\mathbf{x})$  and

$$\int_{\Delta} \overline{L(u^v)[\mathbf{x}]} L'(u^v)[\mathbf{x}] d\mathbf{x} = \mathbf{0} \quad \text{for } \forall \vec{G}^{L'} \in \mathcal{N}^*.$$

Applying Hilbert and Schmidt's theorem ([20]) on integral equation, we know the integral equation

$$F(\mathbf{x}) - \int_{\Delta} K(\mathbf{x}, \mathbf{y}) F(\mathbf{y}) d\mathbf{y} = L(u^v)[\mathbf{x}]$$

is solvable in  $L^2[\Delta]$  if and only if

$$\int_{\Delta} \overline{L(u^v)[\mathbf{x}]} L'(u^v)[\mathbf{x}] d\mathbf{x} = \mathbf{0}$$

for  $\forall \vec{G}^{L'} \in \mathcal{N}^*$ . Thus, there are functions  $F(\mathbf{x}) \in L^2[\Delta]$  hold for the integral equation

$$F(\mathbf{x}) - \int_{\Delta} K(\mathbf{x}, \mathbf{y}) F(\mathbf{y}) d\mathbf{y} = L(u^v)[\mathbf{x}]$$

for  $\forall (u, v) \in X(\vec{G})$  in this case.

For  $\forall u \in V(\vec{G})$ , it is clear that

$$\sum_{v \in N_G(u)} \left( F(u^v)[\mathbf{x}] - \int_{\Delta} \mathbf{K}(\mathbf{x}, \mathbf{y}) \mathbf{F}(u^v)[\mathbf{x}] \right) = \sum_{v \in N_G(u)} L(u^v)[\mathbf{x}] = \mathbf{0},$$

which implies that,

$$\int_{\Delta} K(\mathbf{x}, \mathbf{y}) \left( \sum_{v \in N_G(u)} F(u^v)[\mathbf{x}] \right) = \sum_{v \in N_G(u)} F(u^v)[\mathbf{x}].$$

Thus,

$$\sum_{v \in N_G(u)} F(u^v)[\mathbf{x}] \in \mathcal{N}.$$

However, if  $\dim \mathcal{N} = 0$ , there must be

$$\sum_{v \in N_G(u)} F(u^v)[\mathbf{x}] = \mathbf{0}$$

for  $\forall u \in V(\vec{G})$ , i.e.,  $\vec{G}^F \in \vec{G}^{\mathcal{V}}$ . Whence, if  $\dim \mathcal{N} = 0$ , the integral equation

$$\vec{G}^X - \int_{\Delta} \vec{G}^X = G^L$$

is solvable in  $\vec{G}^{\mathcal{V}}$  with  $\mathcal{V} = L^2[\Delta]$  if and only if

$$\langle \vec{G}^L, \vec{G}^{L'} \rangle = 0, \quad \forall \vec{G}^{L'} \in \mathcal{N}^*.$$

This completes the proof. □

**Theorem 4.7** *Let the integral kernel  $K(\mathbf{x}, \mathbf{y}) : \Delta \times \Delta \rightarrow \mathbb{C} \in L^2(\Delta \times \Delta)$  be given with*

$$\int_{\Delta \times \Delta} |K(\mathbf{x}, \mathbf{y})|^2 d\mathbf{x}d\mathbf{y} > 0, \quad \dim \mathcal{N} = 0 \quad \text{and} \quad \overline{K(\mathbf{x}, \mathbf{y})} = K(\mathbf{x}, \mathbf{y})$$

*for almost all  $(\mathbf{x}, \mathbf{y}) \in \Delta \times \Delta$ . Then there is a finite or countably infinite system  $\vec{G}$ -flows  $\{\vec{G}^{L_i}\}_{i=1,2,\dots} \subset L^2(\Delta, \mathbb{C})$  with associate real numbers  $\{\lambda_i\}_{i=1,2,\dots} \subset \mathbb{R}$  such that the integral equations*

$$\int_{\Delta} K(\mathbf{x}, \mathbf{y}) \vec{G}^{L_i[\mathbf{y}]} d\mathbf{y} = \lambda_i \vec{G}^{L_i[\mathbf{x}]}$$

*hold with integers  $i = 1, 2, \dots$ , and furthermore,*

$$|\lambda_1| \geq |\lambda_2| \geq \dots \geq 0 \quad \text{and} \quad \lim_{i \rightarrow \infty} \lambda_i = 0.$$

*Proof* Notice that the integral equations

$$\int_{\Delta} K(\mathbf{x}, \mathbf{y}) \vec{G}^{L_i[\mathbf{y}]} d\mathbf{y} = \lambda_i \vec{G}^{L_i[\mathbf{x}]}$$

is appeared as

$$\int_{\Delta} K(\mathbf{x}, \mathbf{y}) L_i(u^v)[\mathbf{y}] d\mathbf{y} = \lambda_i \mathbf{L}_i(\mathbf{u}^v)[\mathbf{x}]$$

on  $(u, v) \in X(\vec{G})$ . By the spectral theorem of Hilbert and Schmidt ([20]), there is indeed a finite or countably system of functions  $\{L_i(u^v)[\mathbf{x}]\}_{i=1,2,\dots}$  hold with this integral equation, and furthermore,

$$|\lambda_1| \geq |\lambda_2| \geq \dots \geq 0 \quad \text{with} \quad \lim_{i \rightarrow \infty} \lambda_i = 0.$$

Similar to the proof of Theorem 4.5, if  $\dim \mathcal{N} = 0$ , we know that

$$\sum_{v \in N_G(u)} L_i(u^v)[\mathbf{x}] = \mathbf{0}$$

for  $\forall u \in V(\vec{G})$ , i.e.,  $\vec{G}^{L_i} \in \vec{G}^{\mathcal{V}}$  for integers  $i = 1, 2, \dots$ . □

## 4.2 Non-linear Equations

If  $\vec{G}$  is strong-connected with a special structure, we can get a general result on  $\vec{G}$ -solutions of equations, including non-linear equations following.

**Theorem 4.8** *If the topological graph  $\vec{G}$  is strong-connected with circuit decomposition*

$$\vec{G} = \bigcup_{i=1}^l \vec{C}_i$$

such that  $L(u^v) = L_i(\mathbf{x})$  for  $\forall (u, v) \in X(\vec{C}_i)$ ,  $1 \leq i \leq l$  and the Cauchy problem

$$\begin{cases} \mathcal{F}_i(\mathbf{x}, u, u_{x_1}, \dots, u_{x_n}, u_{x_1 x_2}, \dots) = 0 \\ u|_{x_0} = L_i(\mathbf{x}) \end{cases}$$

is solvable in a Hilbert space  $\mathcal{V}$  on domain  $\Delta \subset \mathbb{R}^n$  for integers  $1 \leq i \leq l$ , then the Cauchy problem

$$\begin{cases} \mathcal{F}_i(\mathbf{x}, X, X_{x_1}, \dots, X_{x_n}, X_{x_1 x_2}, \dots) = 0 \\ X|_{x_0} = \vec{G}^L \end{cases}$$

such that  $L(u^v) = L_i(\mathbf{x})$  for  $\forall (u, v) \in X(\vec{C}_i)$  is solvable for  $X \in \vec{G}^{\mathcal{V}}$ .

*Proof* Let  $X = \vec{G}^{L_{u(\mathbf{x})}}$  with  $L_{u(\mathbf{x})}(u^v) = u(\mathbf{x})$  for  $(u, v) \in X(\vec{G})$ . Notice that the Cauchy problem

$$\begin{cases} \mathcal{F}_i(\mathbf{x}, X, X_{x_1}, \dots, X_{x_n}, X_{x_1 x_2}, \dots) = 0 \\ X|_{x_0} = G^L \end{cases}$$

then appears as

$$\begin{cases} \mathcal{F}_i(\mathbf{x}, u, u_{x_1}, \dots, u_{x_n}, u_{x_1 x_2}, \dots) = 0 \\ u|_{\mathbf{x}_0} = L_i(\mathbf{x}) \end{cases}$$

on the semi-arc  $u^v$  for  $(u, v) \in X(\vec{G})$ , which is solvable by assumption. Whence, there exists solution  $u(u^v)(\mathbf{x})$  holding with

$$\begin{cases} \mathcal{F}_i(\mathbf{x}, u, u_{x_1}, \dots, u_{x_n}, u_{x_1 x_2}, \dots) = 0 \\ u|_{\mathbf{x}_0} = L_i(\mathbf{x}) \end{cases}$$

Let  $\vec{G}^{L_{u(\mathbf{x})}}$  be a labeling on  $\vec{G}$  with  $u(u^v)(\mathbf{x})$  on  $u^v$  for  $\forall (u, v) \in X(\vec{G})$ . We show that  $\vec{G}^{L_{u(\mathbf{x})}} \in \vec{G}^{\mathcal{V}}$ . Notice that

$$\vec{G} = \bigcup_{i=1}^l \vec{C}_i$$

and all flows on  $\vec{C}_i$  is the same, i.e., the solution  $u(u^v)(\mathbf{x})$ . Clearly, it is holden with conservation on each vertex in  $\vec{C}_i$  for integers  $1 \leq i \leq l$ . We therefore know that

$$\sum_{v \in N_G(u)} L_{x_0}(u^v) = 0, \quad u \in V(\vec{G}).$$

Thus,  $\vec{G}^{L_{u(\mathbf{x})}} \in \vec{G}^{\mathcal{V}}$ . This completes the proof. □

There are many interesting conclusions on  $\vec{G}$ -flow solutions of equations by Theorem 4.8. For example, if  $\mathcal{F}_i$  is nothing else but polynomials of degree  $n$  in one variable  $x$ , we get a conclusion following, which generalizes the fundamental theorem in algebra.

**Corollary 4.9** (Generalized Fundamental Theorem in Algebra) *If  $\vec{G}$  is strong-connected with circuit decomposition*

$$\vec{G} = \bigcup_{i=1}^l \vec{C}_i$$

and  $L_i(u^v) = a_i \in \mathbb{C}$  for  $\forall (u, v) \in X(\vec{C}_i)$  and integers  $1 \leq i \leq l$ , then the polynomial

$$F(X) = \vec{G}^{L_1} \circ X^n + \vec{G}^{L_2} \circ X^{n-1} + \dots + \vec{G}^{L_n} \circ X + \vec{G}^{L_{n+1}}$$

always has roots, i.e.,  $X_0 \in \vec{G}^{\mathbb{C}}$  such that  $F(X_0) = \mathbf{0}$  if  $\vec{G}^{L_1} \neq \mathbf{0}$  and  $n \geq 1$ .

Particularly, an algebraic equation

$$a_1 x^n + a_2 x^{n-1} + \dots + a_n x + a_{n+1} = 0$$

with  $a_1 \neq 0$  has infinite many  $\vec{G}$ -flow solutions in  $\vec{G}^{\mathbb{C}}$  on those topological graphs  $\vec{G}$  with

$$\vec{G} = \bigcup_{i=1}^l \vec{C}_i.$$

Notice that Theorem 4.8 enables one to get  $\vec{G}$ -flow solutions both on those linear and non-linear equations in physics. For example, we know the spherical solution

$$ds^2 = f(t) \left(1 - \frac{r_g}{r}\right) dt^2 - \frac{1}{1 - \frac{r_g}{r}} dr^2 - r^2(d\theta^2 + \sin^2 \theta d\phi^2)$$

for the Einstein's gravitational equations ([9])

$$R^{\mu\nu} - \frac{1}{2}Rg^{\mu\nu} = -8\pi GT^{\mu\nu}$$

with  $R^{\mu\nu} = R_{\alpha}^{\mu\alpha\nu} = g_{\alpha\beta}R^{\alpha\mu\beta\nu}$ ,  $R = g_{\mu\nu}R^{\mu\nu}$ ,  $G = 6.673 \times 10^{-8} cm^3/gs^2$ ,  $\kappa = 8\pi G/c^4 = 2.08 \times 10^{-48} cm^{-1} \cdot g^{-1} \cdot s^2$ . By Theorem 4.8, we get their  $\vec{G}$ -flow solutions following.

**Corollary 4.10** *The Einstein's gravitational equations*

$$R^{\mu\nu} - \frac{1}{2}Rg^{\mu\nu} = -8\pi GT^{\mu\nu},$$

has infinite many  $\vec{G}$ -flow solutions in  $\vec{G}^{\mathbb{C}}$ , particularly on those topological graphs  $\vec{G} = \bigcup_{i=1}^l \vec{C}_i$  with spherical solutions of the equations on their arcs.

For example, let  $\vec{G} = \vec{C}_4$ . We are easily find  $\vec{C}_4$ -flow solution of Einstein's gravitational equations, such as those shown in Fig.7.

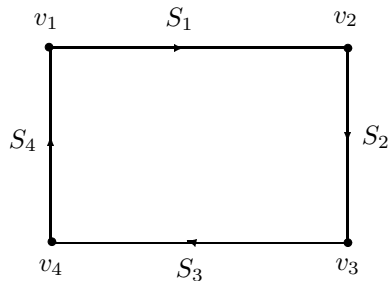

**Fig.7**

where, each  $S_i$  is a spherical solution

$$ds^2 = f(t) \left(1 - \frac{r_s}{r}\right) dt^2 - \frac{1}{1 - \frac{r_s}{r}} dr^2 - r^2(d\theta^2 + \sin^2 \theta d\phi^2)$$

of Einstein's gravitational equations for integers  $1 \leq i \leq 4$ .

As a by-product, Theorems 4.5-4.6 can be also generalized on those topological graphs with circuit-decomposition following.

**Corollary 4.11** *Let the integral kernel  $K(\mathbf{x}, \mathbf{y}) : \Delta \times \Delta \rightarrow \mathbb{C} \in L^2(\Delta \times \Delta)$  be given with*

$$\int_{\Delta \times \Delta} |K(\mathbf{x}, \mathbf{y})|^2 dx dy > 0, \quad \overline{K(\mathbf{x}, \mathbf{y})} = K(\mathbf{x}, \mathbf{y})$$

for almost all  $(\mathbf{x}, \mathbf{y}) \in \Delta \times \Delta$ , and

$$\vec{G}^L = \bigcup_{i=1}^l \vec{C}_i$$

such that  $L(u^v) = L_{[i]}(\mathbf{x})$  for  $\forall(u, v) \in X(\vec{C}_i)$  and integers  $1 \leq i \leq l$ . Then, the integral equation

$$\vec{G}^X - \int_{\Delta} \vec{G}^X = G^L$$

is solvable in  $\vec{G}^{\mathcal{V}}$  with  $\mathcal{V} = L^2[\Delta]$  if and only if

$$\langle \vec{G}^L, \vec{G}^{L'} \rangle = 0, \quad \forall \vec{G}^{L'} \in \mathcal{N}^*.$$

**Corollary 4.12** Let the integral kernel  $K(\mathbf{x}, \mathbf{y}) : \Delta \times \Delta \rightarrow \mathbb{C} \in L^2(\Delta \times \Delta)$  be given with

$$\int_{\Delta \times \Delta} |K(\mathbf{x}, \mathbf{y})|^2 d\mathbf{x}d\mathbf{y} > 0, \quad \overline{K(\mathbf{x}, \mathbf{y})} = K(\mathbf{x}, \mathbf{y})$$

for almost all  $(\mathbf{x}, \mathbf{y}) \in \Delta \times \Delta$ , and

$$\vec{G}^L = \bigcup_{i=1}^l \vec{C}_i$$

such that  $L(u^v) = L_{[i]}(\mathbf{x})$  for  $\forall(u, v) \in X(\vec{C}_i)$  and integers  $1 \leq i \leq l$ . Then, there is a finite or countably infinite system  $\vec{G}$ -flows  $\{\vec{G}^{L_i}\}_{i=1,2,\dots} \subset L^2(\Delta, \mathbb{C})$  with associate real numbers  $\{\lambda_i\}_{i=1,2,\dots} \subset \mathbb{R}$  such that the integral equations

$$\int_{\Delta} K(\mathbf{x}, \mathbf{y}) \vec{G}^{L_i[\mathbf{y}]} d\mathbf{y} = \lambda_i \vec{G}^{L_i[\mathbf{x}]}$$

hold with integers  $i = 1, 2, \dots$ , and furthermore,

$$|\lambda_1| \geq |\lambda_2| \geq \dots \geq 0 \quad \text{and} \quad \lim_{i \rightarrow \infty} \lambda_i = 0.$$

## §5. Applications to System Control

### 5.1 Stability of $\vec{G}$ -Flow Solutions

Let  $X = \vec{G}^{L_{u(\mathbf{x})}}$  and  $X_2 = \vec{G}^{L_{u_1(\mathbf{x})}}$  be respectively solutions of

$$\mathcal{F}(\mathbf{x}, X_{x_1}, \dots, X_{x_n}, X_{x_1 x_2}, \dots) = 0$$

on the initial values  $X|_{\mathbf{x}_0} = \vec{G}^L$  or  $X|_{\mathbf{x}_0} = \vec{G}^{L_1}$  in  $\vec{G}^{\mathcal{V}}$  with  $\mathcal{V} = L^2[\Delta]$ , the Hilbert space. The  $\vec{G}$ -flow solution  $X$  is said to be *stable* if there exists a number  $\delta(\varepsilon)$  for any number  $\varepsilon > 0$

such that

$$\|X_1 - X_2\| = \left\| \vec{G}^{L_{u_1(\mathbf{x})}} - \vec{G}^{L_{u(\mathbf{x})}} \right\| < \varepsilon$$

if  $\left\| \vec{G}^{L_1} - \vec{G}^L \right\| \leq \delta(\varepsilon)$ . By definition,

$$\left\| \vec{G}^{L_1} - \vec{G}^L \right\| = \sum_{(u,v) \in X(\vec{G})} \|L_1(u^v) - L(u^v)\|$$

and

$$\left\| \vec{G}^{L_{u_1(\mathbf{x})}} - \vec{G}^{L_{u(\mathbf{x})}} \right\| = \sum_{(u,v) \in X(\vec{G})} \|u_1(u^v)(\mathbf{x}) - u(u^v)(\mathbf{x})\|.$$

Clearly, if these  $\vec{G}$ -flow solutions  $X$  are stable, then

$$\|u_1(u^v)(\mathbf{x}) - u(u^v)(\mathbf{x})\| \leq \sum_{(u,v) \in X(\vec{G})} \|u_1(u^v)(\mathbf{x}) - u(u^v)(\mathbf{x})\| < \varepsilon$$

if

$$\|L_1(u^v) - L(u^v)\| \leq \sum_{(u,v) \in X(\vec{G})} \|L_1(u^v) - L(u^v)\| \leq \delta(\varepsilon),$$

i.e.,  $u(u^v)(\mathbf{x})$  is stable on  $u^v$  for  $(u, v) \in X(\vec{G})$ .

Conversely, if  $u(u^v)(\mathbf{x})$  is stable on  $u^v$  for  $(u, v) \in X(\vec{G})$ , i.e., for any number  $\varepsilon/\varepsilon(\vec{G}) > 0$  there always is a number  $\delta(\varepsilon)(u^v)$  such that

$$\|u_1(u^v)(\mathbf{x}) - u(u^v)(\mathbf{x})\| < \frac{\varepsilon}{\varepsilon(\vec{G})}$$

if  $\|L_1(u^v) - L(u^v)\| \leq \delta(\varepsilon)(u^v)$ , then there must be

$$\sum_{(u,v) \in X(\vec{G})} \|u_1(u^v)(\mathbf{x}) - u(u^v)(\mathbf{x})\| < \varepsilon(\vec{G}) \times \frac{\varepsilon}{\varepsilon(\vec{G})} = \varepsilon$$

if

$$\|L_1(u^v) - L(u^v)\| \leq \frac{\delta(\varepsilon)}{\varepsilon(\vec{G})},$$

where  $\varepsilon(\vec{G})$  is the number of arcs of  $\vec{G}$  and

$$\delta(\varepsilon) = \min \left\{ \delta(\varepsilon)(u^v) \mid (u, v) \in X(\vec{G}) \right\}.$$

Whence, we get the result following.

**Theorem 5.1** Let  $\mathcal{V}$  be the Hilbert space  $L^2[\Delta]$ . The  $\vec{G}$ -flow solution  $X$  of equation

$$\begin{cases} \mathcal{F}(\mathbf{x}, X, X_{x_1}, \dots, X_{x_n}, X_{x_1 x_2}, \dots) = 0 \\ X|_{x_0} = \vec{G}^L \end{cases}$$

in  $\vec{G}^\mathcal{V}$  is stable if and only if the solution  $u(\mathbf{x}) (u^v)$  of equation

$$\begin{cases} \mathcal{F}(\mathbf{x}, u, u_{x_1}, \dots, u_{x_n}, u_{x_1 x_2}, \dots) = 0 \\ u|_{x_0} = \vec{G}^L \end{cases}$$

is stable on the semi-arc  $u^v$  for  $\forall(u, v) \in X(\vec{G})$ .

This conclusion enables one to find stable  $\vec{G}$ -flow solutions of equations. For example, we know that the stability of trivial solution  $\mathbf{y} = \mathbf{0}$  of an ordinary differential equation

$$\frac{d\mathbf{y}}{d\mathbf{x}} = [A]\mathbf{y}$$

with constant coefficients, is dependent on the number  $\gamma = \max\{\text{Re}\lambda : \lambda \in \sigma[A]\}$  ([23]), i.e., it is stable if and only if  $\gamma < 0$ , or  $\gamma = 0$  but  $m'(\lambda) = m(\lambda)$  for all eigenvalues  $\lambda$  with  $\text{Re}\lambda = 0$ , where  $\sigma[A]$  is the set of eigenvalue of the matrix  $[A]$ ,  $m(\lambda)$  the multiplicity and  $m'(\lambda)$  the dimension of corresponding eigenspace of  $\lambda$ .

**Corollary 5.2** Let  $[A]$  be a matrix with all eigenvalues  $\lambda < 0$ , or  $\gamma = 0$  but  $m'(\lambda) = m(\lambda)$  for all eigenvalues  $\lambda$  with  $\text{Re}\lambda = 0$ . Then the solution  $X = \mathbf{0}$  of differential equation

$$\frac{dX}{d\mathbf{x}} = [A]X$$

is stable in  $\vec{G}^\mathcal{V}$ , where  $\vec{G}$  is such a topological graph that there are  $\vec{G}$ -flows hold with the equation.

For example, the  $\vec{G}$ -flow shown in Fig.8 following

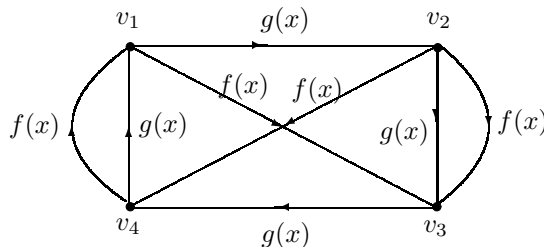

**Fig.8**

is a  $\vec{G}$ -flow solution of the differential equation

$$\frac{d^2 X}{dx^2} + 5 \frac{dX}{dx} + 6X = 0$$



with  $f(x) = C_1e^{-2x} + C_1'e^{-3x}$  and  $g(x) = C_2e^{-2x} + C_2'e^{-3x}$ , where  $C_1, C_1'$  and  $C_2, C_2'$  are constants.

Similarly, applying the stability of solutions of wave equations, heat equations and elliptic equations, the conclusion following is known by Theorem 5.1.

**Corollary 5.3** *Let  $\mathcal{V}$  be the Hilbert space  $L^2[\Delta]$ . Then, the  $\vec{G}$ -flow solutions  $X$  of equations following*

$$\left\{ \begin{array}{l} \frac{\partial^2 X}{\partial t^2} - c^2 \left( \frac{\partial^2 X}{\partial x_1^2} + \frac{\partial^2 X}{\partial x_2^2} \right) = \vec{G}^L \\ X|_{t_0} = \vec{G}^{L\phi(x_1, x_2)}, \quad \frac{\partial X}{\partial t} \Big|_{t_0} = \vec{G}^{L\varphi(x_1, x_2)}, \quad X|_{\partial\Delta} = \vec{G}^{L\mu(t, x_1, x_2)} \end{array} \right. ,$$

$$\left\{ \begin{array}{l} \frac{\partial^2 X}{\partial t^2} - c^2 \frac{\partial X}{\partial x_1} = \vec{G}^L \\ X|_{t_0} = \vec{G}^{L\phi(x_1, x_2)} \end{array} \right. \quad \text{and} \quad \left\{ \begin{array}{l} \frac{\partial^2 X}{\partial x_1^2} + \frac{\partial^2 X}{\partial x_2^2} + \frac{\partial^2 X}{\partial x_3^2} = \mathbf{O} \\ X|_{\partial\Delta} = \vec{G}^{Lg(x_1, x_2, x_3)} \end{array} \right.$$

are stable in  $\vec{G}^{\mathcal{V}}$ , where  $\vec{G}$  is such a topological graph that there are  $\vec{G}$ -flows hold with these equations.

### 5.2 Industrial System Control

An industrial system with raw materials  $M_1, M_2, \dots, M_n$ , products (including by-products)  $P_1, P_2, \dots, P_m$  but  $w_1, w_2, \dots, w_s$  wastes after a produce process, such as those shown in Fig.9 following,

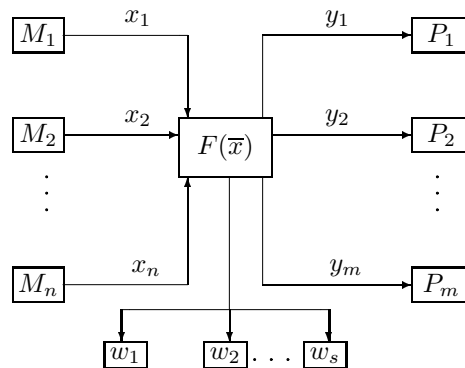

**Fig.9**

i.e., an input-output system, where,

$$(y_1, y_2, \dots, y_m) = F(x_1, x_2, \dots, x_n)$$

determined by differential equations, called the *production function* and constrained with the

conservation law of matter, i.e.,

$$\sum_{i=1}^m y_i + \sum_{i=1}^s w_i = \sum_{i=1}^n x_i.$$

Notice that such an industrial system is an opened system in general, which can be transferred into a closed one by letting the nature as an additional cell, i.e., all materials comes from and all wastes resolves by the nature, a classical one on human beings with the nature. However, the resolvability of nature is very limited. Such a classical system finally resulted in the environmental pollution accompanied with the developed production of human beings.

Different from those of classical industrial systems, an *ecologically industrial system* is a recycling system ([24]), i.e., all outputs of one of its subsystem, including products, by-products provide the inputs of other subsystems and all wastes are disposed harmless to the nature. Clearly, such a system is nothing else but a  $\vec{G}$ -flow because it is holding with conservation laws on each vertex in a topological graph  $\vec{G}$ , where  $\vec{G}$  is determined by the technological process for products, wastes disposal and recycle, and can be characterized by differential equations in Banach space  $\vec{G}^{\mathcal{V}}$ . Whence, we can determine such a system by  $\vec{G}^{L_u}$  with  $L_u : u^v \rightarrow u(u^v)(t, \mathbf{x})$  for  $(u, v) \in X(\vec{G})$ , or ordinary differential equations

$$\begin{cases} \vec{G}^{L_0} \circ \frac{d^k X}{dt^k} + \vec{G}^{L_1} \circ \frac{d^{k-1} X}{dt^{k-1}} + \dots + \vec{G}^{L_{u(t, \mathbf{x})}} = \mathbf{0} \\ X|_{t=t_0} = \vec{G}^{L_{h_0(\mathbf{x})}}, \frac{dX}{dt} \Big|_{t=t_0} = \vec{G}^{L_{h_1(\mathbf{x})}}, \dots, \frac{dX^{k-1}}{dt^{k-1}} \Big|_{t=t_0} = \vec{G}^{L_{h_{k-1}(\mathbf{x})}} \end{cases}$$

for an integer  $k \geq 1$ , or a partial differential equation

$$\begin{cases} \vec{G}^{L_0} \circ \frac{\partial X}{\partial t} + \vec{G}^{L_1} \circ \frac{\partial X}{\partial x_1} + \dots + \vec{G}^{L_n} \circ \frac{\partial X}{\partial x_n} = \vec{G}^{L_{u(t, \mathbf{x})}} \\ X|_{t=t_0} = \vec{G}^{L_{u(\mathbf{x})}} \end{cases}$$

and characterize its stability by Theorem 5.1, where, the coefficients  $\vec{G}^{L_i}, i \geq 0$  are determined by the technological process of production.

## References

- [1] John B.Conway, *A Course in Functional Analysis*, Springer-Verlag New York,Inc., 1990.
- [2] J.L.Gross and T.W.Tucker, *Topological Graph Theory*, John Wiley & Sons, 1987.
- [3] F.John, *Partial Differential Equations* (4th edition), Springer-Verlag New York,Inc., 1982.
- [4] Kenneth Hoffman and Ray Kunze, *Linear Algebra*(Second Edition), Prentice-Hall, Inc. Englewood Cliffs, New Jersey, 1971.
- [5] Linfan Mao, The simple flow representation for graph and its application, Reported at *The First International Symposium on Combinatorial Optimization of China*, Tianjing, 1988.
- [6] Linfan Mao, Analytic graph and its applications, Reported at *The 6<sup>th</sup> Conference on Graph Theory and Its Applications of China*, Qingdao, 1989.

- [7] Linfan Mao, *Automorphism Groups of Maps, Surfaces and Smarandache Geometries*, First edition published by American Research Press in 2005, Second edition is as a Graduate Textbook in Mathematics, Published by The Education Publisher Inc., USA, 2011.
- [8] Linfan Mao, *Smarandache Multi-Space Theory*(Second edition), First edition published by Hexis, Phoenix in 2006, Second edition is as a Graduate Textbook in Mathematics, Published by The Education Publisher Inc., USA, 2011.
- [9] Linfan Mao, *Combinatorial Geometry with Applications to Field Theory*, First edition published by InfoQuest in 2009, Second edition is as a Graduate Textbook in Mathematics, Published by The Education Publisher Inc., USA, 2011.
- [10] Linfan Mao, Non-solvable spaces of linear equation systems. *International J. Math. Combin.*, Vol.2 (2012), 9-23.
- [11] Linfan Mao, Graph structure of manifolds listing, *International J.Contemp. Math. Sciences*, Vol.5, 2011, No.2,71-85.
- [12] Linfan Mao, A generalization of Seifert-Van Kampen theorem for fundamental groups, Far East Journal of Math.Sciences, Vol.61 No.2 (2012), 141-160.
- [13] Linfan Mao, Global stability of non-solvable ordinary differential equations with applications, *International J.Math. Combin.*, Vol.1 (2013), 1-37.
- [14] Linfan Mao, Non-solvable equation systems with graphs embedded in  $\mathbf{R}^n$ , *International J.Math. Combin.*, Vol.2 (2013), 8-23.
- [15] Linfan Mao, Geometry on  $G^L$ -system of homogenous polynomials, *International J.Contemp. Math. Sciences* (Accepted, 2014).
- [16] Linfan Mao, A topological model for ecologically industrial systems, *International J.Math. Combin.*, Vol.1(2014), 109-117.
- [17] Linfan Mao, Cauchy problem on non-solvable system of first order partial differential equations with applications, *Methods and Applications of Analysis* (Accepted).
- [18] Linfan Mao, Mathematics on non-mathematics – a combinatorial contribution, *International J.Math.Combin.*, Vol.3, 2014, 1-34.
- [19] Linfan Mao, Geometry on non-solvable equations – A review on contradictory systems, Reported at the *International Conference on Geometry and Its Applications*, Jarpour University, October 16-18, 2014, Kolkata, India.
- [20] F.Sauvigny, *Partial Differential Equations* (Vol.1 and 2), Springer-Verlag Berlin Heidelberg, 2006.
- [21] F.Smarandache, *Paradoxist Geometry*, State Archives from Valcea, Rm. Valcea, Romania, 1969, and in *Paradoxist Mathematics*, Collected Papers (Vol. II), Kishinev University Press, Kishinev, 5-28, 1997.
- [22] F.Smarandache, Multi-space and multi-structure, in *Neutrosophy. Neutrosophic Logic, Set, Probability and Statistics*, American Research Press, 1998.
- [23] Wolfgang Walter, *Ordinary Differential Equations*, Springer-Verlag New York,Inc., 1998.
- [24] Zengjun Yuan and Jun Bi, *Industrial Ecology* (in Chinese), Science Press, Beijing, 2010.

## Hilbert Flow Spaces with Operators over Topological Graphs

**Abstract:** A complex system  $\mathcal{S}$  consists  $m$  components, maybe inconsistency with  $m \geq 2$ , such as those of biological systems or generally, interaction systems and usually, a system with contradictions, which implies that there are no a mathematical subfield applicable. Then, *how can we hold on its global and local behaviors or reality?* All of us know that there always exists universal connections between things in the world, i.e., a topological graph  $\vec{G}$  underlying components in  $\mathcal{S}$ . We can thereby establish mathematics over graphs  $\vec{G}_1, \vec{G}_2, \dots$  by viewing labeling graphs  $\vec{G}_1^{L_1}, \vec{G}_2^{L_2}, \dots$  to be globally mathematical elements, not only game objects or combinatorial structures, which can be applied to characterize dynamic behaviors of the system  $\mathcal{S}$  on time  $t$ . Formally, a continuity flow  $\vec{G}^L$  is a topological graph  $\vec{G}$  associated with a mapping  $L : (v, u) \rightarrow L(v, u)$ , 2 end-operators  $A_{vu}^+ : L(v, u) \rightarrow L^{A_{vu}^+}(v, u)$  and  $A_{uv}^+ : L(u, v) \rightarrow L^{A_{uv}^+}(u, v)$  on a Banach space  $\mathcal{B}$  over a field  $\mathcal{F}$  with  $L(v, u) = -L(u, v)$  and  $A_{vu}^+(-L(v, u)) = -L^{A_{vu}^+}(v, u)$  for  $\forall (v, u) \in E(\vec{G})$  holding with continuity equations

$$\sum_{u \in N_G(v)} L^{A_{vu}^+}(v, u) = L(v), \quad \forall v \in V(\vec{G}).$$

The main purpose of this paper is to extend Banach or Hilbert spaces to Banach or Hilbert continuity flow spaces over topological graphs  $\{\vec{G}_1, \vec{G}_2, \dots\}$  and establish differentials on continuity flows for characterizing their globally change rate. A few well-known results such as those of Taylor formula, L'Hospital's rule on limitation are generalized to continuity flows, and algebraic or differential flow equations are discussed in this paper. All of these results form the elementary differential theory on continuity flows, which contributes mathematical combinatorics and can be used to characterizing the behavior of complex systems, particularly, the synchronization.

**Key Words:** Complex system, Smarandache multispace, continuity flow, Banach space, Hilbert space, differential, Taylor formula, L'Hospital's rule, mathematical combinatorics.

**AMS(2010):** 34A26, 35A08, 46B25, 92B05, 05C10, 05C21, 34D43, 51D20.

### §1. Introduction

A *Banach* or *Hilbert space* is respectively a linear space  $\mathcal{A}$  over a field  $\mathbb{R}$  or  $\mathbb{C}$  equipped with a complete norm  $\|\cdot\|$  or inner product  $\langle \cdot, \cdot \rangle$ , i.e., for every Cauchy sequence  $\{x_n\}$  in  $\mathcal{A}$ , there

---

<sup>1</sup>An invited J.C.& K.L.Saha Memorial Lecture in the *International Conference on Geometry and Mathematical Models in Complex Phenomena*, December 05-07, 2017.

<sup>2</sup>*International J.Math.Combin.*, Vol.4(2017), 19-45.

exists an element  $x$  in  $\mathcal{A}$  such that

$$\lim_{n \rightarrow \infty} \|x_n - x\|_{\mathcal{A}} = 0 \quad \text{or} \quad \lim_{n \rightarrow \infty} \langle x_n - x, x_n - x \rangle_{\mathcal{A}} = 0$$

and a topological graph  $\varphi(G)$  is an embedding of a graph  $G$  with vertex set  $V(G)$ , edge set  $E(G)$  in a space  $\mathcal{S}$ , i.e., there is a 1 – 1 continuous mapping  $\varphi : G \rightarrow \varphi(G) \subset \mathcal{S}$  with  $\varphi(p) \neq \varphi(q)$  if  $p \neq q$  for  $\forall p, q \in G$ , i.e., edges of  $G$  only intersect at vertices in  $\mathcal{S}$ , an embedding of a topological space to another space. A well-known result on embedding of graphs without loops and multiple edges in  $\mathbb{R}^n$  concluded that *there always exists an embedding of  $G$  that all edges are straight segments in  $\mathbb{R}^n$  for  $n > 3$*  ([22]) such as those shown in Fig.1.

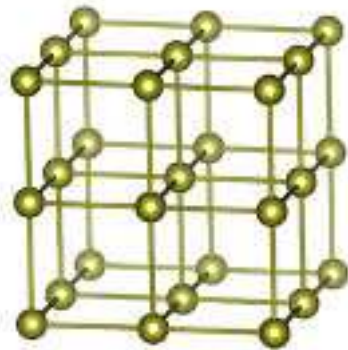

Fig.1

As we known, the purpose of science is hold on the reality of things in the world. However, the reality of a thing  $\mathcal{T}$  is complex and there are no a mathematical subfield applicable unless a system maybe with contradictions in general. *Is such a contradictory system meaningless to human beings?* Certain not because all of these contradictions are the result of human beings, not the nature of things themselves, particularly on those of contradictory systems in mathematics. Thus, holding on the reality of things motivates one to turn contradictory systems to compatible one by a combinatorial notion and establish an envelope theory on mathematics, i.e., mathematical combinatorics ([9]-[13]). Then, *Can we globally characterize the behavior of a system or a population with elements  $\geq 2$ , which maybe contradictory or compatible?* The answer is certainly YES by *continuity flows*, which needs one to establish an envelope mathematical theory over topological graphs, i.e., views labeling graphs  $G^L$  to be mathematical elements ([19]), not only a game object or a combinatorial structure with labels in the following sense.

**Definition 1.1** A continuity flow  $(\vec{G}; L, A)$  is an oriented embedded graph  $\vec{G}$  in a topological space  $\mathcal{S}$  associated with a mapping  $L : v \rightarrow L(v), (v, u) \rightarrow L(v, u)$ , 2 end-operators  $A_{vu}^+ : L(v, u) \rightarrow L^{A_{vu}^+}(v, u)$  and  $A_{uv}^+ : L(u, v) \rightarrow L^{A_{uv}^+}(u, v)$  on a Banach space  $\mathcal{B}$  over a field  $\mathcal{F}$

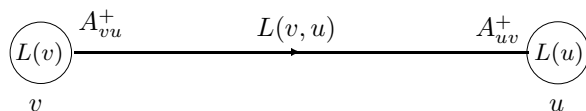

Fig.2

with  $L(v, u) = -L(u, v)$  and  $A_{vu}^+(-L(v, u)) = -L^{A_{vu}^+}(v, u)$  for  $\forall(v, u) \in E(\vec{G})$  holding with continuity equation

$$\sum_{u \in N_G(v)} L^{A_{vu}^+}(v, u) = L(v) \text{ for } \forall v \in V(\vec{G})$$

such as those shown for vertex  $v$  in Fig.3 following

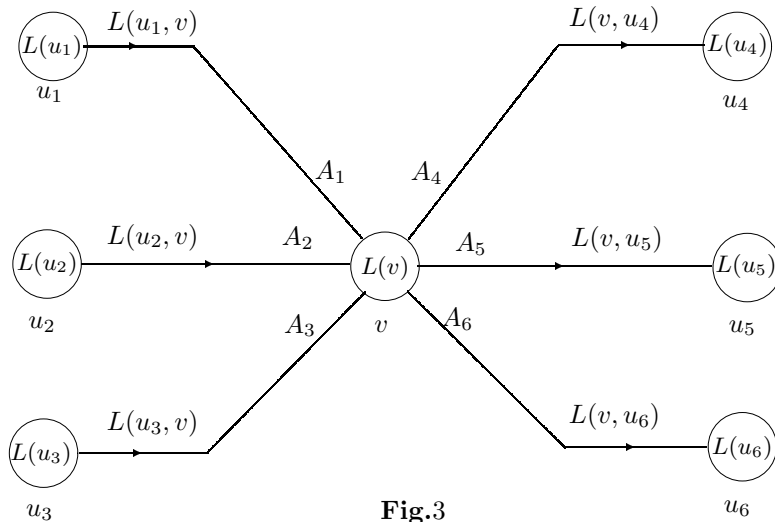

Fig.3

with a continuity equation

$$L^{A_1}(v, u_1) + L^{A_2}(v, u_2) + L^{A_3}(v, u_3) - L^{A_4}(v, u_4) - L^{A_5}(v, u_5) - L^{A_6}(v, u_6) = L(v),$$

where  $L(v)$  is the surplus flow on vertex  $v$ .

Particularly, if  $L(v) = \dot{x}_v$  or constants  $\mathbf{v}_v, v \in V(\vec{G})$ , the continuity flow  $(\vec{G}; L, A)$  is respectively said to be a complex flow or an action  $A$  flow, and  $\vec{G}$ -flow if  $A = \mathbf{1}_\gamma$ , where  $\dot{x}_v = dx_v/dt$ ,  $x_v$  is a variable on vertex  $v$  and  $\mathbf{v}$  is an element in  $\mathcal{B}$  for  $\forall v \in E(\vec{G})$ .

Clearly, an action flow is an equilibrium state of a continuity flow  $(\vec{G}; L, A)$ . We have shown that Banach or Hilbert space can be extended over topological graphs ([14],[17]), which can be applied to understanding the reality of things in [15]-[16], and we also shown that complex flows can be applied to hold on the global stability of biological  $n$ -system with  $n \geq 3$  in [19]. For further discussing continuity flows, we need conceptions following.

**Definition 1.2** Let  $\mathcal{B}_1, \mathcal{B}_2$  be Banach spaces over a field  $\mathbb{F}$  with norms  $\|\cdot\|_1$  and  $\|\cdot\|_2$ , respectively. An operator  $\mathbf{T} : \mathcal{B}_1 \rightarrow \mathcal{B}_2$  is linear if

$$\mathbf{T}(\lambda \mathbf{v}_1 + \mu \mathbf{v}_2) = \lambda \mathbf{T}(\mathbf{v}_1) + \mu \mathbf{T}(\mathbf{v}_2)$$

for  $\lambda, \mu \in \mathbb{F}$ , and  $\mathbf{T}$  is said to be continuous at a vector  $\mathbf{v}_0$  if there always exist such a number

$\delta(\varepsilon)$  for  $\forall \varepsilon > 0$  that

$$\|\mathbf{T}(\mathbf{v}) - \mathbf{T}(\mathbf{v}_0)\|_2 < \varepsilon$$

if  $\|\mathbf{v} - \mathbf{v}_0\|_1 < \delta(\varepsilon)$  for  $\forall \mathbf{v}, \mathbf{v}_0, \mathbf{v}_1, \mathbf{v}_2 \in \mathcal{B}_1$ .

**Definition 1.3** Let  $\mathcal{B}_1, \mathcal{B}_2$  be Banach spaces over a field  $\mathbb{F}$  with norms  $\|\cdot\|_1$  and  $\|\cdot\|_2$ , respectively. An operator  $\mathbf{T} : \mathcal{B}_1 \rightarrow \mathcal{B}_2$  is bounded if there is a constant  $M > 0$  such that

$$\|\mathbf{T}(\mathbf{v})\|_2 \leq M \|\mathbf{v}\|_1, \quad \text{i.e.,} \quad \frac{\|\mathbf{T}(\mathbf{v})\|_2}{\|\mathbf{v}\|_1} \leq M$$

for  $\forall \mathbf{v} \in \mathcal{B}$  and furthermore,  $\mathbf{T}$  is said to be a contractor if

$$\|\mathbf{T}(\mathbf{v}_1) - \mathbf{T}(\mathbf{v}_2)\| \leq c \|\mathbf{v}_1 - \mathbf{v}_2\|$$

for  $\forall \mathbf{v}_1, \mathbf{v}_2 \in \mathcal{B}$  with  $c \in [0, 1)$ .

We only discuss the case that all end-operators  $A_{vu}^+, A_{uv}^+$  are both linear and continuous. In this case, the result following on linear operators of Banach space is useful.

**Theorem 1.4** Let  $\mathcal{B}_1, \mathcal{B}_2$  be Banach spaces over a field  $\mathbb{F}$  with norms  $\|\cdot\|_1$  and  $\|\cdot\|_2$ , respectively. Then, a linear operator  $\mathbf{T} : \mathcal{B}_1 \rightarrow \mathcal{B}_2$  is continuous if and only if it is bounded, or equivalently,

$$\|\mathbf{T}\| := \sup_{\mathbf{0} \neq \mathbf{v} \in \mathcal{B}_1} \frac{\|\mathbf{T}(\mathbf{v})\|_2}{\|\mathbf{v}\|_1} < +\infty.$$

Let  $\{\vec{G}_1, \vec{G}_2, \dots\}$  be a graph family. The main purpose of this paper is to extend Banach or Hilbert spaces to Banach or Hilbert continuity flow spaces over topological graphs  $\{\vec{G}_1, \vec{G}_2, \dots\}$  and establish differentials on continuity flows, which enables one to characterize their globally change rate constraint on the combinatorial structure. A few well-known results such as those of Taylor formula, L'Hospital's rule on limitation are generalized to continuity flows, and algebraic or differential flow equations are discussed in this paper. All of these results form the elementary differential theory on continuity flows, which contributes mathematical combinatorics and can be used to characterizing the behavior of complex systems, particularly, the synchronization.

For terminologies and notations not defined in this paper, we follow references [1] for mechanics, [4] for functionals and linear operators, [22] for topology, [8] combinatorial geometry, [6]-[7],[25] for Smarandache systems, Smarandache geometries and Smaarandache multispaces and [2], [20] for biological mathematics.

## §2. Banach and Hilbert Flow Spaces

### 2.1 Linear Spaces over Graphs

Let  $\vec{G}_1, \vec{G}_2, \dots, \vec{G}_n$  be oriented graphs embedded in topological space  $\mathcal{S}$  with  $\vec{\mathcal{G}} = \bigcup_{i=1}^n \vec{G}_i$ ,

i.e.,  $\vec{G}_i$  is a subgraph of  $\vec{\mathcal{G}}$  for integers  $1 \leq i \leq n$ . In this case, there is naturally an embedding  $\iota: \vec{G}_i \rightarrow \vec{\mathcal{G}}$ .

Let  $\mathcal{V}$  be a linear space over a field  $\mathcal{F}$ . A vector labeling  $L: \vec{G} \rightarrow \mathcal{V}$  is a mapping with  $L(v), L(e) \in \mathcal{V}$  for  $\forall v \in V(\vec{G}), e \in E(\vec{G})$ . Define

$$\vec{G}_1^{L_1} + \vec{G}_2^{L_2} = \left(\vec{G}_1 \setminus \vec{G}_2\right)^{L_1} \cup \left(\vec{G}_1 \cap \vec{G}_2\right)^{L_1+L_2} \cup \left(\vec{G}_2 \setminus \vec{G}_1\right)^{L_2} \quad (2.1)$$

and

$$\lambda \cdot \vec{G}^L = \vec{G}^{\lambda \cdot L} \quad (2.2)$$

for  $\forall \lambda \in \mathcal{F}$ . Clearly, if  $\vec{G}^L, \vec{G}_1^{L_1}, \vec{G}_2^{L_2}$  are continuity flows with linear end-operators  $A_{vu}^+$  and  $A_{uv}^+$  for  $\forall (v, u) \in E(\vec{G})$ ,  $\vec{G}_1^{L_1} + \vec{G}_2^{L_2}$  and  $\lambda \cdot \vec{G}^L$  are continuity flows also. If we consider each continuity flow  $\vec{G}_i^L$  a continuity subflow of  $\vec{\mathcal{G}}^{\hat{L}}$ , where  $\hat{L}: \vec{G}_i = L(\vec{G}_i)$  but  $\hat{L}: \vec{\mathcal{G}} \setminus \vec{G}_i \rightarrow \mathbf{0}$  for integers  $1 \leq i \leq n$ , and define  $\mathbf{0}: \vec{\mathcal{G}} \rightarrow \mathbf{0}$ , then all continuity flows, particularly, all complex flows, or all action flows on oriented graphs  $\vec{G}_1, \vec{G}_2, \dots, \vec{G}_n$  naturally form a linear space, denoted by  $\left(\langle \vec{G}_i, 1 \leq i \leq n \rangle^{\mathcal{V}}; +, \cdot\right)$  over a field  $\mathcal{F}$  under operations (2.1) and (2.2) because it holds with:

(1) A field  $\mathcal{F}$  of scalars;

(2) A set  $\langle \vec{G}_i, 1 \leq i \leq n \rangle^{\mathcal{V}}$  of objects, called continuity flows;

(3) An operation “+”, called continuity flow addition, which associates with each pair of continuity flows  $\vec{G}_1^{L_1}, \vec{G}_2^{L_2}$  in  $\langle \vec{G}_i, 1 \leq i \leq n \rangle^{\mathcal{V}}$  a continuity flow  $\vec{G}_1^{L_1} + \vec{G}_2^{L_2}$  in  $\langle \vec{G}_i, 1 \leq i \leq n \rangle^{\mathcal{V}}$ , called the sum of  $\vec{G}_1^{L_1}$  and  $\vec{G}_2^{L_2}$ , in such a way that

(a) Addition is commutative,  $\vec{G}_1^{L_1} + \vec{G}_2^{L_2} = \vec{G}_2^{L_2} + \vec{G}_1^{L_1}$  because of

$$\begin{aligned} \vec{G}_1^{L_1} + \vec{G}_2^{L_2} &= \left(\vec{G}_1 \setminus \vec{G}_2\right)^{L_1} \cup \left(\vec{G}_1 \cap \vec{G}_2\right)^{L_1+L_2} \cup \left(\vec{G}_2 \setminus \vec{G}_1\right)^{L_2} \\ &= \left(\vec{G}_2 \setminus \vec{G}_1\right)^{L_2} \cup \left(\vec{G}_1 \cap \vec{G}_2\right)^{L_2+L_1} \cup \left(\vec{G}_1 \setminus \vec{G}_2\right)^{L_1} \\ &= \vec{G}_2^{L_2} + \vec{G}_1^{L_1}; \end{aligned}$$

(b) Addition is associative,  $\left(\vec{G}_1^{L_1} + \vec{G}_2^{L_2}\right) + \vec{G}_3^{L_3} = \vec{G}_1^{L_1} + \left(\vec{G}_2^{L_2} + \vec{G}_3^{L_3}\right)$  because if we let

$$L_{ijk}^+(x) = \begin{cases} L_i(x), & \text{if } x \in \vec{G}_i \setminus \left(\vec{G}_j \cup \vec{G}_k\right) \\ L_j(x), & \text{if } x \in \vec{G}_j \setminus \left(\vec{G}_i \cup \vec{G}_k\right) \\ L_k(x), & \text{if } x \in \vec{G}_k \setminus \left(\vec{G}_i \cup \vec{G}_j\right) \\ L_{ij}^+(x), & \text{if } x \in \left(\vec{G}_i \cap \vec{G}_j\right) \setminus \vec{G}_k \\ L_{ik}^+(x), & \text{if } x \in \left(\vec{G}_i \cap \vec{G}_k\right) \setminus \vec{G}_j \\ L_{jk}^+(x), & \text{if } x \in \left(\vec{G}_j \cap \vec{G}_k\right) \setminus \vec{G}_i \\ L_i(x) + L_j(x) + L_k(x) & \text{if } x \in \vec{G}_i \cap \vec{G}_j \cap \vec{G}_k \end{cases} \quad (2.3)$$



and

$$L_{ij}^+(x) = \begin{cases} L_i(x), & \text{if } x \in \vec{G}_i \setminus \vec{G}_j \\ L_j(x), & \text{if } x \in \vec{G}_j \setminus \vec{G}_i \\ L_i(x) + L_j(x), & \text{if } x \in \vec{G}_i \cap \vec{G}_j \end{cases} \quad (2.4)$$

for integers  $1 \leq i, j, k \leq n$ , then

$$\begin{aligned} (\vec{G}_1^{L_1} + \vec{G}_2^{L_2}) + \vec{G}_3^{L_3} &= (\vec{G}_1 \cup \vec{G}_2)^{L_{12}^+} + \vec{G}_3^{L_3} = (\vec{G}_1 \cup \vec{G}_2 \cup \vec{G}_3)^{L_{123}^+} \\ &= \vec{G}_1^{L_1} + (\vec{G}_2 \cup \vec{G}_3)^{L_{23}^+} = \vec{G}_1^{L_1} + (\vec{G}_2^{L_2} + \vec{G}_3^{L_3}); \end{aligned}$$

(c) There is a unique continuity flow  $\mathbf{O}$  on  $\vec{\mathcal{G}}$  hold with  $\mathbf{O}(v, u) = \mathbf{0}$  for  $\forall(v, u) \in E(\vec{\mathcal{G}})$  and  $V(\vec{\mathcal{G}})$  in  $\langle \vec{G}_i, 1 \leq i \leq n \rangle^{\mathcal{Y}}$ , called zero such that  $\vec{G}^L + \mathbf{O} = \vec{G}^L$  for  $\vec{G}^L \in \langle \vec{G}_i, 1 \leq i \leq n \rangle^{\mathcal{Y}}$ ;

(d) For each continuity flow  $\vec{G}^L \in \langle \vec{G}_i, 1 \leq i \leq n \rangle^{\mathcal{Y}}$  there is a unique continuity flow  $\vec{G}^{-L}$  such that  $\vec{G}^L + \vec{G}^{-L} = \mathbf{O}$ ;

(4) An operation “ $\cdot$ ”, called scalar multiplication, which associates with each scalar  $k$  in  $F$  and a continuity flow  $\vec{G}^L$  in  $\langle \vec{G}_i, 1 \leq i \leq n \rangle^{\mathcal{Y}}$  a continuity flow  $k \cdot \vec{G}^L$  in  $\mathcal{Y}$ , called the product of  $k$  with  $\vec{G}^L$ , in such a way that

- (a)  $1 \cdot \vec{G}^L = \vec{G}^L$  for every  $\vec{G}^L$  in  $\langle \vec{G}_i, 1 \leq i \leq n \rangle^{\mathcal{Y}}$ ;
- (b)  $(k_1 k_2) \cdot \vec{G}^L = k_1 (k_2 \cdot \vec{G}^L)$ ;
- (c)  $k \cdot (\vec{G}_1^{L_1} + \vec{G}_2^{L_2}) = k \cdot \vec{G}_1^{L_1} + k \cdot \vec{G}_2^{L_2}$ ;
- (d)  $(k_1 + k_2) \cdot \vec{G}^L = k_1 \cdot \vec{G}^L + k_2 \cdot \vec{G}^L$ .

Usually, we abbreviate  $(\langle \vec{G}_i, 1 \leq i \leq n \rangle^{\mathcal{Y}}; +, \cdot)$  to  $\langle \vec{G}_i, 1 \leq i \leq n \rangle^{\mathcal{Y}}$  if these operations  $+$  and  $\cdot$  are clear in the context.

By operation (1.1),  $\vec{G}_1^{L_1} + \vec{G}_2^{L_2} \neq \vec{G}_1^{L_1}$  if and only if  $\vec{G}_1 \not\subseteq \vec{G}_2$  with  $L_1 : \vec{G}_1 \setminus \vec{G}_2 \not\rightarrow \mathbf{0}$  and  $\vec{G}_1^{L_1} + \vec{G}_2^{L_2} \neq \vec{G}_2^{L_2}$  if and only if  $\vec{G}_2 \not\subseteq \vec{G}_1$  with  $L_2 : \vec{G}_2 \setminus \vec{G}_1 \not\rightarrow \mathbf{0}$ , which allows us to introduce the conception of linear irreducible. Generally, a continuity flow family  $\{\vec{G}_1^{L_1}, \vec{G}_2^{L_2}, \dots, \vec{G}_n^{L_n}\}$  is *linear irreducible* if for any integer  $i$ ,

$$\vec{G}_i \not\subseteq \bigcup_{l \neq i} \vec{G}_l \quad \text{with} \quad L_i : \vec{G}_i \setminus \bigcup_{l \neq i} \vec{G}_l \not\rightarrow \mathbf{0}, \quad (2.5)$$

where  $1 \leq i \leq n$ . We know the following result on linear generated sets.

**Theorem 2.1** *Let  $\mathcal{V}$  be a linear space over a field  $\mathcal{F}$  and let  $\{\vec{G}_1^{L_1}, \vec{G}_2^{L_2}, \dots, \vec{G}_n^{L_n}\}$  be an linear irreducible family,  $L_i : \vec{G}_i \rightarrow \mathcal{V}$  for integers  $1 \leq i \leq n$  with linear operators  $A_{vu}^+$ ,  $A_{uv}^+$  for  $\forall(v, u) \in E(\vec{G})$ . Then,  $\{\vec{G}_1^{L_1}, \vec{G}_2^{L_2}, \dots, \vec{G}_n^{L_n}\}$  is an independent generated set of*

$\langle \vec{G}_i, 1 \leq i \leq n \rangle^{\mathcal{V}}$ , called basis, i.e.,

$$\dim \langle \vec{G}_i, 1 \leq i \leq n \rangle^{\mathcal{V}} = n.$$

*Proof* By definition,  $\vec{G}_i^{L_i}, 1 \leq i \leq n$  is a linear generated of  $\langle \vec{G}_i, 1 \leq i \leq n \rangle^{\mathcal{V}}$  with  $L_i: \vec{G}_i \rightarrow \mathcal{V}$ , i.e.,

$$\dim \langle \vec{G}_i, 1 \leq i \leq n \rangle^{\mathcal{V}} \leq n.$$

We only need to show that  $\vec{G}_i^{L_i}, 1 \leq i \leq n$  is linear independent, i.e.,

$$\dim \langle \vec{G}_i, 1 \leq i \leq n \rangle^{\mathcal{V}} \geq n,$$

which implies that if there are  $n$  scalars  $c_1, c_2, \dots, c_n$  holding with

$$c_1 \vec{G}_1^{L_1} + c_2 \vec{G}_2^{L_2} + \dots + c_n \vec{G}_n^{L_n} = \mathbf{0},$$

then  $c_1 = c_2 = \dots = c_n = 0$ . Notice that  $\{\vec{G}_1, \vec{G}_2, \dots, \vec{G}_n\}$  is linear irreducible. We are easily know  $\vec{G}_i \setminus \bigcup_{l \neq i} \vec{G}_l \neq \emptyset$  and find an element  $x \in E(\vec{G}_i \setminus \bigcup_{l \neq i} \vec{G}_l)$  such that  $c_i L_i(x) = \mathbf{0}$  for integer  $i, 1 \leq i \leq n$ . However,  $L_i(x) \neq \mathbf{0}$  by (1.5). We get that  $c_i = 0$  for integers  $1 \leq i \leq n$ .  $\square$

A subspace of  $\langle \vec{G}_i, 1 \leq i \leq n \rangle^{\mathcal{V}}$  is called an  $A_0$ -flow space if its elements are all continuity flows  $\vec{G}^L$  with  $L(v), v \in V(\vec{G})$  are constant  $\mathbf{v}$ . The result following is an immediately conclusion of Theorem 2.1.

**Theorem 2.2** Let  $\vec{G}, \vec{G}_1, \vec{G}_2, \dots, \vec{G}_n$  be oriented graphs embedded in a space  $\mathcal{S}$  and  $\mathcal{V}$  a linear space over a field  $\mathcal{F}$ . If  $\vec{G}^{\mathbf{v}}, \vec{G}_1^{\mathbf{v}_1}, \vec{G}_2^{\mathbf{v}_2}, \dots, \vec{G}_n^{\mathbf{v}_n}$  are continuity flows with  $\mathbf{v}(v) = \mathbf{v}, \mathbf{v}_i(v) = \mathbf{v}_i \in \mathcal{V}$  for  $\forall v \in V(\vec{G}), 1 \leq i \leq n$ , then

(1)  $\langle \vec{G}^{\mathbf{v}} \rangle$  is an  $A_0$ -flow space;

(2)  $\langle \vec{G}_1^{\mathbf{v}_1}, \vec{G}_2^{\mathbf{v}_2}, \dots, \vec{G}_n^{\mathbf{v}_n} \rangle$  is an  $A_0$ -flow space if and only if  $\vec{G}_1 = \vec{G}_2 = \dots = \vec{G}_n$  or  $\mathbf{v}_1 = \mathbf{v}_2 = \dots = \mathbf{v}_n = \mathbf{0}$ .

*Proof* By definition,  $\vec{G}_1^{\mathbf{v}_1} + \vec{G}_2^{\mathbf{v}_2}$  and  $\lambda \vec{G}^{\mathbf{v}}$  are  $A_0$ -flows if and only if  $\vec{G}_1 = \vec{G}_2$  or  $\mathbf{v}_1 = \mathbf{v}_2 = \mathbf{0}$  by definition. We therefore know this result.  $\square$

## 2.2 Commutative Rings over Graphs

Furthermore, if  $\mathcal{V}$  is a commutative ring  $(\mathcal{R}; +, \cdot)$ , we can extend it over oriented graph family  $\{\vec{G}_1, \vec{G}_2, \dots, \vec{G}_n\}$  by introducing operation  $+$  with (2.1) and operation  $\cdot$  following:

$$\vec{G}_1^{L_1} \cdot \vec{G}_2^{L_2} = (\vec{G}_1 \setminus \vec{G}_2)^{L_1} \cup (\vec{G}_1 \cap \vec{G}_2)^{L_1 \cdot L_2} \cup (\vec{G}_2 \setminus \vec{G}_1)^{L_2}, \quad (2.6)$$

where  $L_1 \cdot L_2 : x \rightarrow L_1(x) \cdot L_2(x)$ , and particularly, the scalar product for  $\mathbb{R}^n, n \geq 2$  for  $x \in \vec{G}_1 \cap \vec{G}_2$ .

As we shown in Subsection 2.1,  $\left(\langle \vec{G}_i, 1 \leq i \leq n \rangle^{\mathcal{R}} ; +\right)$  is an Abelian group. We show  $\left(\langle \vec{G}_i, 1 \leq i \leq n \rangle^{\mathcal{R}} ; +, \cdot\right)$  is a commutative semigroup also.

In fact, define

$$L_{ij}^{\times}(x) = \begin{cases} L_i(x), & \text{if } x \in \vec{G}_i \setminus \vec{G}_j \\ L_j(x), & \text{if } x \in \vec{G}_j \setminus \vec{G}_i \\ L_i(x) \cdot L_j(x), & \text{if } x \in \vec{G}_i \cap \vec{G}_j \end{cases}$$

Then, we are easily known that  $\vec{G}_1^{L_1} \cdot \vec{G}_2^{L_2} = \left(\vec{G}_1 \cup \vec{G}_2\right)^{L_{12}^{\times}} = \left(\vec{G}_1 \cup \vec{G}_2\right)^{L_{21}^{\times}} = \vec{G}_2^{L_2} \cdot \vec{G}_1^{L_1}$  for  $\forall \vec{G}_1^{L_1}, \vec{G}_2^{L_2} \in \left(\langle \vec{G}_i, 1 \leq i \leq n \rangle^{\mathcal{R}} ; \cdot\right)$  by definition (2.6), i.e., it is commutative.

Let

$$L_{ijk}^{\times}(x) = \begin{cases} L_i(x), & \text{if } x \in \vec{G}_i \setminus \left(\vec{G}_j \cup \vec{G}_k\right) \\ L_j(x), & \text{if } x \in \vec{G}_j \setminus \left(\vec{G}_i \cup \vec{G}_k\right) \\ L_k(x), & \text{if } x \in \vec{G}_k \setminus \left(\vec{G}_i \cup \vec{G}_j\right) \\ L_{ij}(x), & \text{if } x \in \left(\vec{G}_i \cap \vec{G}_j\right) \setminus \vec{G}_k \\ L_{ik}(x), & \text{if } x \in \left(\vec{G}_i \cap \vec{G}_k\right) \setminus \vec{G}_j \\ L_{jk}(x), & \text{if } x \in \left(\vec{G}_j \cap \vec{G}_k\right) \setminus \vec{G}_i \\ L_i(x) \cdot L_j(x) \cdot L_k(x) & \text{if } x \in \vec{G}_i \cap \vec{G}_j \cap \vec{G}_k \end{cases}$$

Then,

$$\begin{aligned} \left(\vec{G}_1^{L_1} \cdot \vec{G}_2^{L_2}\right) \cdot \vec{G}_3^{L_3} &= \left(\vec{G}_1 \cup \vec{G}_2\right)^{L_{12}^{\times}} \cdot \vec{G}_3^{L_3} = \left(\vec{G}_1 \cup \vec{G}_2 \cup \vec{G}_3\right)^{L_{123}^{\times}} \\ &= \vec{G}_1^{L_1} \cdot \left(\vec{G}_2 \cup \vec{G}_3\right)^{L_{23}^{\times}} = \vec{G}_1^{L_1} \cdot \left(\vec{G}_2^{L_2} \cdot \vec{G}_3^{L_3}\right). \end{aligned}$$

Thus,

$$\left(\vec{G}_1^{L_1} \cdot \vec{G}_2^{L_2}\right) \cdot \vec{G}_3^{L_3} = \vec{G}_1^{L_1} \cdot \left(\vec{G}_2^{L_2} \cdot \vec{G}_3^{L_3}\right)$$

for  $\forall \vec{G}^L, \vec{G}_1^{L_1}, \vec{G}_2^{L_2} \in \left(\langle \vec{G}_i, 1 \leq i \leq n \rangle^{\mathcal{R}} ; \cdot\right)$ , which implies that it is a semigroup.

We are also need to verify the distributive laws, i.e.,

$$\vec{G}_3^{L_3} \cdot \left(\vec{G}_1^{L_1} + \vec{G}_2^{L_2}\right) = \vec{G}_3^{L_3} \cdot \vec{G}_1^{L_1} + \vec{G}_3^{L_3} \cdot \vec{G}_2^{L_2} \quad (2.7)$$

and

$$\left(\vec{G}_1^{L_1} + \vec{G}_2^{L_2}\right) \cdot \vec{G}_3^{L_3} = \vec{G}_1^{L_1} \cdot \vec{G}_3^{L_3} + \vec{G}_2^{L_2} \cdot \vec{G}_3^{L_3} \quad (2.8)$$

for  $\forall \vec{G}_3, \vec{G}_1, \vec{G}_2 \in \left( \left\langle \vec{G}_i, 1 \leq i \leq n \right\rangle^{\mathcal{R}} ; +, \cdot \right)$ . Clearly,

$$\begin{aligned} \vec{G}_3^{L_3} \cdot (\vec{G}_1^{L_1} + \vec{G}_2^{L_2}) &= \vec{G}_3^{L_3} \cdot (\vec{G}_1 \cup \vec{G}_2)^{L_{12}^+} = (\vec{G}_3 (\vec{G}_1 \cup \vec{G}_2))^{L_{3(21)}^\times} \\ &= (\vec{G}_3 \cup \vec{G}_1)^{L_{31}^\times} \cup (\vec{G}_3 \cup \vec{G}_2)^{L_{32}^\times} = \vec{G}_3^{L_3} \cdot \vec{G}_1^{L_1} + \vec{G}_3^{L_3} \cdot \vec{G}_2^{L_2}, \end{aligned}$$

which is the (2.7). The proof for (2.8) is similar. Thus, we get the following result.

**Theorem 2.3** *Let  $(\mathcal{R}; +, \cdot)$  be a commutative ring and let  $\{\vec{G}_1^{L_1}, \vec{G}_2^{L_2}, \dots, \vec{G}_n^{L_n}\}$  be a linear irreducible family,  $L_i : \vec{G}_i \rightarrow \mathcal{R}$  for integers  $1 \leq i \leq n$  with linear operators  $A_{vu}^+, A_{uv}^+$  for  $\forall (v, u) \in E(\vec{G})$ . Then,  $\left( \left\langle \vec{G}_i, 1 \leq i \leq n \right\rangle^{\mathcal{R}} ; +, \cdot \right)$  is a commutative ring.*

### 2.3 Banach or Hilbert Flow Spaces

Let  $\{\vec{G}_1^{L_1}, \vec{G}_2^{L_2}, \dots, \vec{G}_n^{L_n}\}$  be a basis of  $\left\langle \vec{G}_i, 1 \leq i \leq n \right\rangle^{\mathcal{V}}$ , where  $\mathcal{V}$  is a Banach space with a norm  $\|\cdot\|$ . For  $\forall \vec{G}^L \in \left\langle \vec{G}_i, 1 \leq i \leq n \right\rangle^{\mathcal{V}}$ , define

$$\|\vec{G}^L\| = \sum_{e \in E(\vec{G})} \|L(e)\|. \quad (2.9)$$

Then, for  $\forall \vec{G}, \vec{G}_1^{L_1}, \vec{G}_2^{L_2} \in \left\langle \vec{G}_i, 1 \leq i \leq n \right\rangle^{\mathcal{V}}$  we are easily know that

- (1)  $\|\vec{G}^L\| \geq 0$  and  $\|\vec{G}^L\| = 0$  if and only if  $\vec{G}^L = \mathbf{0}$ ;
- (2)  $\|\vec{G}^{\xi L}\| = \xi \|\vec{G}^L\|$  for any scalar  $\xi$ ;
- (3)  $\|\vec{G}_1^{L_1} + \vec{G}_2^{L_2}\| \leq \|\vec{G}_1^{L_1}\| + \|\vec{G}_2^{L_2}\|$  because of

$$\begin{aligned} \|\vec{G}_1^{L_1} + \vec{G}_2^{L_2}\| &= \sum_{e \in E(\vec{G}_1 \setminus \vec{G}_2)} \|L_1(e)\| \\ &\quad + \sum_{e \in E(\vec{G}_1 \cap \vec{G}_2)} \|L_1(e) + L_2(e)\| + \sum_{e \in E(\vec{G}_2 \setminus \vec{G}_1)} \|L_2(e)\| \\ &\leq \left( \sum_{e \in E(\vec{G}_1 \setminus \vec{G}_2)} \|L_1(e)\| + \sum_{e \in E(\vec{G}_1 \cap \vec{G}_2)} \|L_1(e)\| \right) \\ &\quad + \left( \sum_{e \in E(\vec{G}_2 \setminus \vec{G}_1)} \|L_2(e)\| + \sum_{e \in E(\vec{G}_1 \cap \vec{G}_2)} \|L_2(e)\| \right) = \|\vec{G}_1^{L_1}\| + \|\vec{G}_2^{L_2}\|. \end{aligned}$$

for  $\|L_1(e) + L_2(e)\| \leq \|L_1(e)\| + \|L_2(e)\|$  in Banach space  $\mathcal{V}$ . Therefore,  $\|\cdot\|$  is also a norm

on  $\langle \vec{G}_i, 1 \leq i \leq n \rangle^{\mathcal{V}}$ .

Furthermore, if  $\mathcal{V}$  is a Hilbert space with an inner product  $\langle \cdot, \cdot \rangle$ , for  $\forall \vec{G}_1^{L_1}, \vec{G}_2^{L_2} \in \langle \vec{G}_i, 1 \leq i \leq n \rangle^{\mathcal{V}}$ , define

$$\begin{aligned} \langle \vec{G}_1^{L_1}, \vec{G}_2^{L_2} \rangle &= \sum_{e \in E(\vec{G}_1 \setminus \vec{G}_2)} \langle L_1(e), L_1(e) \rangle \\ &+ \sum_{e \in E(\vec{G}_1 \cap \vec{G}_2)} \langle L_1(e), L_2(e) \rangle + \sum_{e \in E(\vec{G}_2 \setminus \vec{G}_1)} \langle L_2(e), L_2(e) \rangle. \end{aligned} \quad (2.10)$$

Then we are easily know also that

(1) For  $\forall \vec{G}^L \in \langle \vec{G}_i, 1 \leq i \leq n \rangle^{\mathcal{V}}$ ,

$$\langle \vec{G}^L, \vec{G}^L \rangle = \sum_{e \in E(\vec{G})} \langle L(e), L(e) \rangle \geq 0$$

and  $\langle \vec{G}^L, \vec{G}^L \rangle = 0$  if and only if  $\vec{G}^L = \mathbf{0}$ .

(2) For  $\forall \vec{G}_1^{L_1}, \vec{G}_2^{L_2} \in \langle \vec{G}_i, 1 \leq i \leq n \rangle^{\mathcal{V}}$ ,

$$\langle \vec{G}_1^{L_1}, \vec{G}_2^{L_2} \rangle = \overline{\langle \vec{G}_2^{L_2}, \vec{G}_1^{L_1} \rangle}$$

because of

$$\begin{aligned} \langle \vec{G}_1^{L_1}, \vec{G}_2^{L_2} \rangle &= \sum_{e \in E(\vec{G}_1 \setminus \vec{G}_2)} \langle L_1(e), L_1(e) \rangle + \sum_{e \in E(\vec{G}_1 \cap \vec{G}_2)} \langle L_1(e), L_2(e) \rangle \\ &+ \sum_{e \in E(\vec{G}_2 \setminus \vec{G}_1)} \langle L_2(e), L_2(e) \rangle \\ &= \sum_{e \in E(\vec{G}_1 \setminus \vec{G}_2)} \overline{\langle L_1(e), L_1(e) \rangle} + \sum_{e \in E(\vec{G}_1 \cap \vec{G}_2)} \overline{\langle L_2(e), L_1(e) \rangle} \\ &+ \sum_{e \in E(\vec{G}_2 \setminus \vec{G}_1)} \overline{\langle L_2(e), L_2(e) \rangle} = \overline{\langle \vec{G}_2^{L_2}, \vec{G}_1^{L_1} \rangle} \end{aligned}$$

for  $\langle L_1(e), L_2(e) \rangle = \overline{\langle L_2(e), L_1(e) \rangle}$  in Hilbert space  $\mathcal{V}$ .

(3) For  $\vec{G}^L, \vec{G}_1^{L_1}, \vec{G}_2^{L_2} \in \langle \vec{G}_i, 1 \leq i \leq n \rangle^{\mathcal{V}}$  and  $\lambda, \mu \in \mathcal{F}$ , there is

$$\langle \lambda \vec{G}_1^{L_1} + \mu \vec{G}_2^{L_2}, \vec{G}^L \rangle = \lambda \langle \vec{G}_1^{L_1}, \vec{G}^L \rangle + \mu \langle \vec{G}_2^{L_2}, \vec{G}^L \rangle$$

because of

$$\begin{aligned} & \langle \lambda \vec{G}_1^{L_1} + \mu \vec{G}_2^{L_2}, \vec{G}^L \rangle = \langle \vec{G}_1^{\lambda L_1} + \vec{G}_2^{\mu L_2}, \vec{G}^L \rangle \\ & = \left\langle (\vec{G}_1 \setminus \vec{G}_2)^{\lambda L_1} \cup (\vec{G}_1 \cap \vec{G}_2)^{\lambda L_1 + \mu L_2} \cup (\vec{G}_2 \setminus \vec{G}_1)^{\mu L_2}, \vec{G}^L \right\rangle. \end{aligned}$$

Define  $L_{1\lambda 2\mu} : \vec{G}_1 \cup \vec{G}_2 \rightarrow \mathcal{V}$  by

$$L_{1\lambda 2\mu}(x) = \begin{cases} \lambda L_1(x), & \text{if } x \in \vec{G}_1 \setminus \vec{G}_2 \\ \mu L_2(x), & \text{if } x \in \vec{G}_2 \setminus \vec{G}_1 \\ \lambda L_1(x) + \mu L_2(x), & \text{if } x \in \vec{G}_2 \cap \vec{G}_1 \end{cases}$$

Then, we know that

$$\begin{aligned} \langle \lambda \vec{G}_1^{L_1} + \mu \vec{G}_2^{L_2}, \vec{G}^L \rangle & = \sum_{e \in E((\vec{G}_1 \cup \vec{G}_2) \setminus \vec{G})} \langle L_{1\lambda 2\mu}(e), L_{1\lambda 2\mu}(e) \rangle \\ & + \sum_{e \in E((\vec{G}_1 \cup \vec{G}_2) \cap \vec{G})} \langle L_{1\lambda 2\mu}(e), L(e) \rangle \\ & + \sum_{e \in E(\vec{G} \setminus (\vec{G}_1 \cup \vec{G}_2))} \langle L(e), L(e) \rangle. \end{aligned}$$

and

$$\begin{aligned} & \lambda \langle \vec{G}_1^{L_1}, \vec{G}^L \rangle + \mu \langle \vec{G}_2^{L_2}, \vec{G}^L \rangle \\ & = \sum_{e \in E(\vec{G}_1 \setminus \vec{G})} \langle \lambda L_1(e), \lambda L_1(e) \rangle + \sum_{e \in E(\vec{G}_1 \cap \vec{G})} \langle \lambda L_1(e), L(e) \rangle \\ & + \sum_{e \in E(\vec{G} \setminus \vec{G}_1)} \langle L(e), L(e) \rangle + \sum_{e \in E(\vec{G}_2 \setminus \vec{G})} \langle \mu L_2(e), \mu L_2(e) \rangle \\ & + \sum_{e \in E(\vec{G}_2 \cap \vec{G})} \langle \mu L_2(e), L(e) \rangle + \sum_{e \in E(\vec{G} \setminus \vec{G}_2)} \langle L(e), L(e) \rangle. \end{aligned}$$

Notice that

$$\begin{aligned} & \sum_{e \in E((\vec{G}_1 \cup \vec{G}_2) \setminus \vec{G})} \langle L_{1\lambda 2\mu}(e), L_{1\lambda 2\mu}(e) \rangle \\ & = \sum_{e \in E(\vec{G}_1 \setminus \vec{G})} \langle \lambda L_1(e), \lambda L_1(e) \rangle + \sum_{e \in E(\vec{G}_2 \setminus \vec{G})} \langle \mu L_2(e), \mu L_2(e) \rangle \\ & + \sum_{e \in E((\vec{G}_1 \cup \vec{G}_2) \cap \vec{G})} \langle L_{1\lambda 2\mu}(e), L(e) \rangle \end{aligned}$$

$$\begin{aligned}
&= \sum_{e \in E(\vec{G}_1 \cap \vec{G})} \langle \lambda L_1(e), L(e) \rangle + \sum_{e \in E(\vec{G}_2 \cap \vec{G})} \langle \mu L_2(e), L(e) \rangle \\
&+ \sum_{e \in E(\vec{G} \setminus \vec{G}_2)} \langle L(e), L(e) \rangle \\
&= \sum_{e \in E(\vec{G} \setminus \vec{G}_1)} \langle L(e), L(e) \rangle + \sum_{e \in E(\vec{G} \setminus \vec{G}_2)} \langle L(e), L(e) \rangle.
\end{aligned}$$

We therefore know that

$$\langle \lambda \vec{G}_1^{L_1} + \mu \vec{G}_2^{L_2}, \vec{G}^L \rangle = \lambda \langle \vec{G}_1^{L_1}, \vec{G}^L \rangle + \mu \langle \vec{G}_2^{L_2}, \vec{G}^L \rangle.$$

Thus,  $\vec{G}^{\mathcal{V}}$  is an inner space

If  $\{\vec{G}_1^{L_1}, \vec{G}_2^{L_2}, \dots, \vec{G}_n^{L_n}\}$  is a basis of space  $\langle \vec{G}_i, 1 \leq i \leq n \rangle^{\mathcal{V}}$ , we are easily find the exact formula on  $L$  by  $L_1, L_2, \dots, L_n$ . In fact, let

$$\vec{G}^L = \lambda_1 \vec{G}_1^{L_1} + \lambda_2 \vec{G}_2^{L_2} + \dots + \lambda_n \vec{G}_n^{L_n},$$

where  $(\lambda_1, \lambda_2, \dots, \lambda_n) \neq (0, 0, \dots, 0)$ , and let

$$\hat{L} : \left( \bigcap_{l=1}^i \vec{G}_{k_l} \right) \setminus \left( \bigcup_{s \neq k_1, \dots, k_i} \vec{G}_s \right) \rightarrow \sum_{l=1}^i \lambda_{k_l} L_{k_l}$$

for integers  $1 \leq i \leq n$ . Then, we are easily knowing that  $\hat{L}$  is nothing else but the labeling  $L$  on  $\vec{G}$  by operation (2.1), a generation of (2.3) and (2.4) with

$$\|\vec{G}^L\| = \sum_{i=1}^n \sum_{e \in E(\vec{G}_i)} \left\| \sum_{l=1}^i \lambda_{k_l} L_{k_l}(e) \right\|, \quad (2.11)$$

$$\langle \vec{G}^L, \vec{G}^{L'} \rangle = \sum_{i=1}^n \sum_{e \in E(\vec{G}_i)} \left\langle \sum_{l=1}^i \lambda_{k_l} L_{k_l}^1(e), \sum_{s=1}^i \lambda'_{k_s} L_{k_s}^2(e) \right\rangle, \quad (2.12)$$

where  $\vec{G}^{L'} = \lambda'_1 \vec{G}_1^{L_1} + \lambda'_2 \vec{G}_2^{L_2} + \dots + \lambda'_n \vec{G}_n^{L_n}$  and  $\vec{G}_i = \left( \bigcap_{l=1}^i \vec{G}_{k_l} \right) \setminus \left( \bigcup_{s \neq k_1, \dots, k_i} \vec{G}_s \right)$ .

We therefore extend the Banach or Hilbert space  $\mathcal{V}$  over graphs  $\vec{G}_1, \vec{G}_2, \dots, \vec{G}_n$  following.

**Theorem 2.4** *Let  $\vec{G}_1, \vec{G}_2, \dots, \vec{G}_n$  be oriented graphs embedded in a space  $\mathcal{S}$  and  $\mathcal{V}$  a Banach space over a field  $\mathcal{F}$ . Then  $\langle \vec{G}_i, 1 \leq i \leq n \rangle^{\mathcal{V}}$  with linear operators  $A_{vu}^+, A_{uv}^+$  for  $\forall (v, u) \in E(\vec{G})$  is a Banach space, and furthermore, if  $\mathcal{V}$  is a Hilbert space,  $\langle \vec{G}_i, 1 \leq i \leq n \rangle^{\mathcal{V}}$  is a Hilbert space too.*

*Proof* We have shown,  $\langle \vec{G}_i, 1 \leq i \leq n \rangle^{\mathcal{V}}$  is a linear normed space or inner space if  $\mathcal{V}$  is a linear normed space or inner space, and for the later, let

$$\|\vec{G}^L\| = \sqrt{\langle \vec{G}^L, \vec{G}^L \rangle}$$

for  $\vec{G}^L \in \langle \vec{G}_i, 1 \leq i \leq n \rangle^{\mathcal{V}}$ . Then  $\langle \vec{G}_i, 1 \leq i \leq n \rangle^{\mathcal{V}}$  is a normed space and furthermore, it is a Hilbert space if it is complete. Thus, we are only need to show that any Cauchy sequence is converges in  $\langle \vec{G}_i, 1 \leq i \leq n \rangle^{\mathcal{V}}$ .

In fact, let  $\{\vec{H}_n^{L_n}\}$  be a Cauchy sequence in  $\langle \vec{G}_i, 1 \leq i \leq n \rangle^{\mathcal{V}}$ , i.e., for any number  $\varepsilon > 0$ , there always exists an integer  $N(\varepsilon)$  such that

$$\|\vec{H}_n^{L_n} - \vec{H}_m^{L_m}\| < \varepsilon$$

if  $n, m \geq N(\varepsilon)$ . Let  $\mathcal{G}^{\mathcal{V}}$  be the continuity flow space on  $\vec{\mathcal{G}} = \bigcup_{i=1}^n \vec{G}_i$ . We embed each  $\vec{H}_n^{L_n}$  to a  $\vec{\mathcal{G}}\hat{L} \in \vec{\mathcal{G}}^{\mathcal{V}}$  by letting

$$\hat{L}_n(e) = \begin{cases} L_n(e), & \text{if } e \in E(H_n) \\ \mathbf{0}, & \text{if } e \in E(\vec{\mathcal{G}} \setminus \vec{H}_n). \end{cases}$$

Then

$$\begin{aligned} \|\vec{\mathcal{G}}\hat{L}_n - \vec{\mathcal{G}}\hat{L}_m\| &= \sum_{e \in E(\vec{G}_n \setminus \vec{G}_m)} \|L_n(e)\| + \sum_{e \in E(\vec{G}_n \cap \vec{G}_m)} \|L_n(e) - L_m(e)\| \\ &+ \sum_{e \in E(\vec{G}_m \setminus \vec{G}_n)} \|-L_m(e)\| = \|\vec{H}_n^{L_n} - \vec{H}_m^{L_m}\| \leq \varepsilon. \end{aligned}$$

Thus,  $\{\vec{\mathcal{G}}\hat{L}_n\}$  is a Cauchy sequence also in  $\vec{\mathcal{G}}^{\mathcal{V}}$ . By definition,

$$\|\hat{L}_n(e) - \hat{L}_m(e)\| \leq \|\vec{\mathcal{G}}\hat{L}_n - \vec{\mathcal{G}}\hat{L}_m\| < \varepsilon,$$

i.e.,  $\{L_n(e)\}$  is a Cauchy sequence for  $\forall e \in E(\vec{\mathcal{G}})$ , which is converges on in  $\mathcal{V}$  by definition.

Let

$$\hat{L}(e) = \lim_{n \rightarrow \infty} \hat{L}_n(e)$$

for  $\forall e \in E(\vec{\mathcal{G}})$ . Then it is clear that  $\lim_{n \rightarrow \infty} \vec{\mathcal{G}}\hat{L}_n = \vec{\mathcal{G}}\hat{L}$ , which implies that  $\{\vec{\mathcal{G}}\hat{L}_n\}$ , i.e.,  $\{\vec{H}_n^{L_n}\}$  is converges to  $\vec{\mathcal{G}}\hat{L} \in \vec{\mathcal{G}}^{\mathcal{V}}$ , an element in  $\langle \vec{G}_i, 1 \leq i \leq n \rangle^{\mathcal{V}}$  because of  $\hat{L}(e) \in \mathcal{V}$  for  $\forall e \in E(\vec{\mathcal{G}})$  and  $\vec{\mathcal{G}} = \bigcup_{i=1}^n \vec{G}_i$ .  $\square$



### §3. Differential on Continuity Flows

#### 3.1 Continuity Flow Expansion

Theorem 2.4 enables one to establish differentials and generalizes results in classical calculus in space  $\langle \vec{G}_i, 1 \leq i \leq n \rangle^{\mathcal{Y}}$ . Let  $L$  be  $k$ th differentiable to  $t$  on a domain  $\mathcal{D} \subset \mathbb{R}$ , where  $k \geq 1$ . Define

$$\frac{d\vec{G}^L}{dt} = \vec{G} \frac{dL}{dt} \quad \text{and} \quad \int_0^t \vec{G}^L dt = \vec{G}_0^{\int_0^t L dt}.$$

Then, we are easily to generalize Taylor formula in  $\langle \vec{G}_i, 1 \leq i \leq n \rangle^{\mathcal{Y}}$  following.

**Theorem 3.1**(Taylor) *Let  $\vec{G}^L \in \langle \vec{G}_i, 1 \leq i \leq n \rangle^{\mathbb{R} \times \mathbb{R}^n}$  and there exist  $k$ th order derivative of  $L$  to  $t$  on a domain  $\mathcal{D} \subset \mathbb{R}$ , where  $k \geq 1$ . If  $A_{vu}^+, A_{uv}^+$  are linear for  $\forall (v, u) \in E(\vec{G})$ , then*

$$\vec{G}^L = \vec{G}^{L(t_0)} + \frac{t-t_0}{1!} \vec{G}^{L'(t_0)} + \dots + \frac{(t-t_0)^k}{k!} \vec{G}^{L^{(k)}(t_0)} + o\left((t-t_0)^{-k} \vec{G}\right), \quad (3.1)$$

for  $\forall t_0 \in \mathcal{D}$ , where  $o\left((t-t_0)^{-k} \vec{G}\right)$  denotes such an infinitesimal term  $\widehat{L}$  of  $L$  that

$$\lim_{t \rightarrow t_0} \frac{\widehat{L}(v, u)}{(t-t_0)^k} = 0 \quad \text{for} \quad \forall (v, u) \in E(\vec{G}).$$

Particularly, if  $L(v, u) = f(t)c_{vu}$ , where  $c_{vu}$  is a constant, denoted by  $f(t)\vec{G}^{L_C}$  with  $L_C : (v, u) \rightarrow c_{vu}$  for  $\forall (v, u) \in E(\vec{G})$  and

$$f(t) = f(t_0) + \frac{(t-t_0)}{1!} f'(t_0) + \frac{(t-t_0)^2}{2!} f''(t_0) + \dots + \frac{(t-t_0)^k}{k!} f^{(k)}(t_0) + o\left((t-t_0)^k\right),$$

then

$$f(t)\vec{G}^{L_C} = f(t) \cdot \vec{G}^{L_C}.$$

*Proof* Notice that  $L(v, u)$  has  $k$ th order derivative to  $t$  on  $\mathcal{D}$  for  $\forall (v, u) \in E(\vec{G})$ . By applying Taylor formula on  $t_0$ , we know that

$$L(v, u) = L(v, u)(t_0) + \frac{L'(v, u)(t_0)}{1!} (t-t_0) + \dots + \frac{L^{(k)}(v, u)(t_0)}{k!} + o\left((t-t_0)^k\right)$$

if  $t \rightarrow t_0$ , where  $o\left((t-t_0)^k\right)$  is an infinitesimal term  $\widehat{L}(v, u)$  of  $L(v, u)$  hold with

$$\lim_{t \rightarrow t_0} \frac{\widehat{L}(v, u)}{(t-t_0)^k} = 0$$

for  $\forall(v, u) \in E(\vec{G})$ . By operations (2.1) and (2.2),

$$\vec{G}^{L_1} + \vec{G}^{L_2} = \vec{G}^{L_1+L_2} \quad \text{and} \quad \lambda \vec{G}^L = \vec{G}^{\lambda \vec{L}}$$

because  $A_{vu}^+, A_{uv}^+$  are linear for  $\forall(v, u) \in E(\vec{G})$ . We therefore get

$$\vec{G}^L = \vec{G}^{L(t_0)} + \frac{(t-t_0)}{1!} \vec{G}^{L'(t_0)} + \dots + \frac{(t-t_0)^k}{k!} \vec{G}^{L^{(k)}(t_0)} + o\left((t-t_0)^{-k} \vec{G}\right)$$

for  $t_0 \in \mathcal{D}$ , where  $o\left((t-t_0)^{-k} \vec{G}\right)$  is an infinitesimal term  $\widehat{L}$  of  $L$ , i.e.,

$$\lim_{t \rightarrow t_0} \frac{\widehat{L}(v, u)}{(t-t_0)^t} = 0$$

for  $\forall(v, u) \in E(\vec{G})$ . Calculation also shows that

$$\begin{aligned} f(t) \vec{G}^{L_C(v, u)} &= \vec{G}^{f(t)L_C(v, u)} = \vec{G}^{\left(f(t_0) + \frac{(t-t_0)}{1!} f'(t_0) \dots + \frac{(t-t_0)^k}{k!} f^{(k)}(t_0) + o\left((t-t_0)^k\right)\right) c_{vu}} \\ &= f(t_0) c_{vu} \vec{G} + \frac{f'(t_0)(t-t_0)}{1!} c_{vu} \vec{G} + \frac{f''(t_0)(t-t_0)^2}{2!} c_{vu} \vec{G} \\ &\quad + \dots + \frac{f^{(k)}(t_0)(t-t_0)^k}{k!} c_{vu} \vec{G} + o\left((t-t_0)^k\right) \vec{G} \\ &= \left(f(t_0) + \frac{(t-t_0)}{1!} f'(t_0) \dots + \frac{(t-t_0)^k}{k!} f^{(k)}(t_0) + o\left((t-t_0)^k\right)\right) c_{vu} \vec{G} \\ &= f(t) c_{vu} \vec{G} = f(t) \cdot \vec{G}^{L_C(v, u)}, \end{aligned}$$

i.e.,

$$f(t) \vec{G}^{L_C} = f(t) \cdot \vec{G}^{L_C}.$$

This completes the proof.  $\square$

Taylor expansion formula for continuity flow  $\vec{G}^L$  enables one to find interesting results on  $\vec{G}^L$  such as those of the following.

**Theorem 3.2** *Let  $f(t)$  be a  $k$  differentiable function to  $t$  on a domain  $\mathcal{D} \subset \mathbb{R}$  with  $0 \in \mathcal{D}$  and  $f(0\vec{G}) = f(0)\vec{G}$ . If  $A_{vu}^+, A_{uv}^+$  are linear for  $\forall(v, u) \in E(\vec{G})$ , then*

$$f(t)\vec{G} = f\left(t\vec{G}\right). \quad (3.2)$$

*Proof* Let  $t_0 = 0$  in the Taylor formula. We know that

$$f(t) = f(0) + \frac{f'(0)}{1!}t + \frac{f''(0)}{2!}t^2 + \dots + \frac{f^{(k)}(0)}{k!}t^k + o(t^k).$$

Notice that

$$\begin{aligned} f(t)\vec{G} &= \left( f(0) + \frac{f'(0)}{1!}t + \frac{f''(0)}{2!}t^2 + \cdots + \frac{f^{(k)}(0)}{k!}t^k + o(t^k) \right) \vec{G} \\ &= \vec{G}f(0) + \frac{f'(0)}{1!}t\vec{G} + \frac{f''(0)}{2!}t^2\vec{G} + \cdots + \frac{f^{(k)}(0)}{k!}t^k\vec{G} + o(t^k) \\ &= f(0)\vec{G} + \frac{f'(0)t}{1!}\vec{G} + \cdots + \frac{f^{(k)}(0)t^k}{k!}\vec{G} + o(t^k)\vec{G} \end{aligned}$$

and by definition,

$$\begin{aligned} f(t\vec{G}) &= f(0\vec{G}) + \frac{f'(0)}{1!}(t\vec{G}) + \frac{f''(0)}{2!}(t\vec{G})^2 \\ &\quad + \cdots + \frac{f^{(k)}(0)}{k!}(t\vec{G})^k + o\left((t\vec{G})^k\right) \\ &= f(0\vec{G}) + \frac{f'(0)}{1!}t\vec{G} + \frac{f''(0)}{2!}t^2\vec{G} + \cdots + \frac{f^{(k)}(0)}{k!}t^k\vec{G} + o(t^k)\vec{G} \end{aligned}$$

because of  $(t\vec{G})^i = \vec{G}^{t^i} = t^i\vec{G}$  for any integer  $1 \leq i \leq k$ . Notice that  $f(0\vec{G}) = f(0)\vec{G}$ . We therefore get that

$$f(t)\vec{G} = f(t\vec{G}). \quad \square$$

Theorem 3.2 enables one easily getting Taylor expansion formulas by  $f(t\vec{G})$ . For example, let  $f(t) = e^t$ . Then

$$e^t\vec{G} = e^{t\vec{G}} \quad (3.3)$$

by Theorem 3.5. Notice that  $(e^t)' = e^t$  and  $e^0 = 1$ . We know that

$$e^t\vec{G} = e^t\vec{G} = \vec{G} + \frac{t}{1!}\vec{G} + \frac{t^2}{2!}\vec{G} + \cdots + \frac{t^k}{k!}\vec{G} + \cdots \quad (3.4)$$

and

$$e^t\vec{G} \cdot e^s\vec{G} = \vec{G}e^t \cdot \vec{G}e^s = \vec{G}e^t \cdot e^s = \vec{G}e^{t+s} = e^{(t+s)}\vec{G}, \quad (3.5)$$

where  $t$  and  $s$  are variables, and similarly, for a real number  $\alpha$  if  $|t| < 1$ ,

$$\left(\vec{G} + t\vec{G}\right)^\alpha = \vec{G} + \frac{\alpha t}{1!}\vec{G} + \cdots + \frac{\alpha(\alpha-1)\cdots(\alpha-n+1)t^n}{n!}\vec{G} + \cdots \quad (3.6)$$

### 3.2 Limitation

**Definition 3.3** Let  $\vec{G}^L, \vec{G}_1^{L_1} \in \langle \vec{G}_i, 1 \leq i \leq n \rangle^\gamma$  with  $L, L_1$  dependent on a variable  $t \in [a, b] \subset (-\infty, +\infty)$  and linear continuous end-operators  $A_{vu}^+$  for  $\forall (v, u) \in E(\vec{G})$ . For  $t_0 \in [a, b]$  and any number  $\varepsilon > 0$ , if there is always a number  $\delta(\varepsilon)$  such that if  $|t - t_0| \leq \delta(\varepsilon)$  then  $\|\vec{G}_1^{L_1} - \vec{G}^L\| < \varepsilon$ , then,  $\vec{G}_1^{L_1}$  is said to be converged to  $\vec{G}^L$  as  $t \rightarrow t_0$ , denoted by  $\lim_{t \rightarrow t_0} \vec{G}_1^{L_1} = \vec{G}^L$ . Particularly, if  $\vec{G}^L$  is a continuity flow with a constant  $L(v)$  for  $\forall v \in V(\vec{G})$  and  $t_0 = +\infty$ ,  $\vec{G}_1^{L_1}$  is said to be  $\vec{G}$ -synchronized.

Applying Theorem 1.4, we know that there are positive constants  $c_{vu} \in \mathbb{R}$  such that  $\|A_{vu}^+\| \leq c_{vu}^+$  for  $\forall (v, u) \in E(\vec{G})$ .

By definition, it is clear that

$$\begin{aligned} & \left\| \vec{G}_1^{L_1} - \vec{G}^L \right\| \\ &= \left\| (\vec{G}_1 \setminus \vec{G})^{L_1} \right\| + \left\| (\vec{G}_1 \cap \vec{G})^{L_1 - L} \right\| + \left\| (\vec{G} \setminus \vec{G}_1)^{-L} \right\| \\ &= \sum_{u \in N_{\vec{G}_1 \setminus \vec{G}}(v)} \left\| L_1^{A'_{vu}+}(v, u) \right\| + \sum_{u \in N_{\vec{G}_1 \cap \vec{G}}(v)} \left\| (L_1^{A'_{vu}+} - L_{vu}^{A'_{vu}+})(v, u) \right\| + \sum_{u \in N_{\vec{G} \setminus \vec{G}_1}(v)} \left\| -L^{A'_{vu}+}(v, u) \right\| \\ &\leq \sum_{u \in N_{\vec{G}_1 \setminus \vec{G}}(v)} c_{vu}^+ \|L_1(v, u)\| + \sum_{u \in N_{\vec{G}_1 \cap \vec{G}}(v)} c_{vu}^+ \|(L_1 - L)(v, u)\| + \sum_{u \in N_{\vec{G} \setminus \vec{G}_1}(v)} c_{vu}^+ \|-L(v, u)\|. \end{aligned}$$

and  $\|L(v, u)\| \geq 0$  for  $(v, u) \in E(\vec{G})$  and  $E(\vec{G}_1)$ . Let

$$c_{\vec{G}_1 \vec{G}}^{\max} = \left\{ \max_{(v, u) \in E(\vec{G}_1)} c_{vu}^+, \max_{(v, u) \in E(\vec{G}_1)} c_{vu}^+ \right\}.$$

If  $\left\| \vec{G}_1^{L_1} - \vec{G}^L \right\| < \varepsilon$ , we easily get that  $\|L_1(v, u)\| < c_{\vec{G}_1 \vec{G}}^{\max} \varepsilon$  for  $(v, u) \in E(\vec{G}_1 \setminus \vec{G})$ ,  $\|(L_1 - L)(v, u)\| < c_{\vec{G}_1 \vec{G}}^{\max} \varepsilon$  for  $(v, u) \in E(\vec{G}_1 \cap \vec{G})$  and  $\|-L(v, u)\| < c_{\vec{G}_1 \vec{G}}^{\max} \varepsilon$  for  $(v, u) \in E(\vec{G} \setminus \vec{G}_1)$ .

Conversely, if  $\|L_1(v, u)\| < \varepsilon$  for  $(v, u) \in E(\vec{G}_1 \setminus \vec{G})$ ,  $\|(L_1 - L)(v, u)\| < \varepsilon$  for  $(v, u) \in E(\vec{G}_1 \cap \vec{G})$  and  $\|-L(v, u)\| < \varepsilon$  for  $(v, u) \in E(\vec{G} \setminus \vec{G}_1)$ , we easily know that

$$\begin{aligned} \left\| \vec{G}_1^{L_1} - \vec{G}^L \right\| &= \sum_{u \in N_{\vec{G}_1 \setminus \vec{G}}(v)} \left\| L_1^{A'_{vu}+}(v, u) \right\| + \sum_{u \in N_{\vec{G}_1 \cap \vec{G}}(v)} \left\| (L_1^{A'_{vu}+} - L_{vu}^{A'_{vu}+})(v, u) \right\| \\ &+ \sum_{u \in N_{\vec{G} \setminus \vec{G}_1}(v)} \left\| -L^{A'_{vu}+}(v, u) \right\| \\ &\leq \sum_{u \in N_{\vec{G}_1 \setminus \vec{G}}(v)} c_{vu}^+ \|L_1(v, u)\| + \sum_{u \in N_{\vec{G}_1 \cap \vec{G}}(v)} c_{vu}^+ \|(L_1 - L)(v, u)\| \\ &+ \sum_{u \in N_{\vec{G} \setminus \vec{G}_1}(v)} c_{vu}^+ \|-L(v, u)\| \\ &< \left| \vec{G}_1 \setminus \vec{G} \right| c_{\vec{G}_1 \vec{G}}^{\max} \varepsilon + \left| \vec{G}_1 \cap \vec{G} \right| c_{\vec{G}_1 \vec{G}}^{\max} \varepsilon + \left| \vec{G} \setminus \vec{G}_1 \right| c_{\vec{G}_1 \vec{G}}^{\max} \varepsilon = \left| \vec{G}_1 \cup \vec{G} \right| c_{\vec{G}_1 \vec{G}}^{\max} \varepsilon. \end{aligned}$$

Thus, we get an equivalent condition for  $\lim_{t \rightarrow t_0} \vec{G}_1^{L_1} = \vec{G}^L$  following.

**Theorem 3.4**  $\lim_{t \rightarrow t_0} \vec{G}_1^{L_1} = \vec{G}^L$  if and only if for any number  $\varepsilon > 0$  there is always a number  $\delta(\varepsilon)$  such that if  $|t - t_0| \leq \delta(\varepsilon)$  then  $\|L_1(v, u)\| < \varepsilon$  for  $(v, u) \in E(\vec{G}_1 \setminus \vec{G})$ ,  $\|(L_1 - L)(v, u)\| < \varepsilon$  for  $(v, u) \in E(\vec{G}_1 \cap \vec{G})$  and  $\|-L(v, u)\| < \varepsilon$  for  $(v, u) \in E(\vec{G} \setminus \vec{G}_1)$ , i.e.,  $\vec{G}_1^{L_1} - \vec{G}^L$  is an infinitesimal or  $\lim_{t \rightarrow t_0} (\vec{G}_1^{L_1} - \vec{G}^L) = \mathbf{O}$ .

If  $\lim_{t \rightarrow t_0} \vec{G}^L$ ,  $\lim_{t \rightarrow t_0} \vec{G}_1^{L_1}$  and  $\lim_{t \rightarrow t_0} \vec{G}_2^{L_2}$  exist, the formulas following are clearly true by definition:

$$\begin{aligned}\lim_{t \rightarrow t_0} \left( \vec{G}_1^{L_1} + \vec{G}_2^{L_2} \right) &= \lim_{t \rightarrow t_0} \vec{G}_1^{L_1} + \lim_{t \rightarrow t_0} \vec{G}_2^{L_2}, \\ \lim_{t \rightarrow t_0} \left( \vec{G}_1^{L_1} \cdot \vec{G}_2^{L_2} \right) &= \lim_{t \rightarrow t_0} \vec{G}_1^{L_1} \cdot \lim_{t \rightarrow t_0} \vec{G}_2^{L_2}, \\ \lim_{t \rightarrow t_0} \left( \vec{G}^L \cdot \left( \vec{G}_1^{L_1} + \vec{G}_2^{L_2} \right) \right) &= \lim_{t \rightarrow t_0} \vec{G}^L \cdot \lim_{t \rightarrow t_0} \vec{G}_1^{L_1} + \lim_{t \rightarrow t_0} \vec{G}^L \cdot \lim_{t \rightarrow t_0} \vec{G}_2^{L_2}, \\ \lim_{t \rightarrow t_0} \left( \left( \vec{G}_1^{L_1} + \vec{G}_2^{L_2} \right) \cdot \vec{G}^L \right) &= \lim_{t \rightarrow t_0} \vec{G}_1^{L_1} \cdot \lim_{t \rightarrow t_0} \vec{G}^L + \lim_{t \rightarrow t_0} \vec{G}_2^{L_2} \cdot \lim_{t \rightarrow t_0} \vec{G}^L\end{aligned}$$

and furthermore, if  $\lim_{t \rightarrow t_0} \vec{G}_2^{L_2} \neq \mathbf{O}$ , then

$$\lim_{t \rightarrow t_0} \left( \frac{\vec{G}_1^{L_1}}{\vec{G}_2^{L_2}} \right) = \lim_{t \rightarrow t_0} \left( \vec{G}_1^{L_1} \cdot \vec{G}_2^{L_2^{-1}} \right) = \frac{\lim_{t \rightarrow t_0} \vec{G}_1^{L_1}}{\lim_{t \rightarrow t_0} \vec{G}_2^{L_2}}.$$

**Theorem 3.5**(L'Hospital's rule) *If  $\lim_{t \rightarrow t_0} \vec{G}_1^{L_1} = \mathbf{O}$ ,  $\lim_{t \rightarrow t_0} \vec{G}_2^{L_2} = \mathbf{O}$  and  $L_1, L_2$  are differentiable respect to  $t$  with  $\lim_{t \rightarrow t_0} L'_1(v, u) = 0$  for  $(v, u) \in E(\vec{G}_1 \setminus \vec{G}_2)$ ,  $\lim_{t \rightarrow t_0} L'_2(v, u) \neq 0$  for  $(v, u) \in E(\vec{G}_1 \cap \vec{G}_2)$  and  $\lim_{t \rightarrow t_0} L'_2(v, u) = 0$  for  $(v, u) \in E(\vec{G}_2 \setminus \vec{G}_1)$ , then,*

$$\lim_{t \rightarrow t_0} \left( \frac{\vec{G}_1^{L_1}}{\vec{G}_2^{L_2}} \right) = \frac{\lim_{t \rightarrow t_0} \vec{G}_1^{L'_1}}{\lim_{t \rightarrow t_0} \vec{G}_2^{L'_2}}.$$

*Proof* By definition, we know that

$$\begin{aligned}\lim_{t \rightarrow t_0} \left( \frac{\vec{G}_1^{L_1}}{\vec{G}_2^{L_2}} \right) &= \lim_{t \rightarrow t_0} \left( \vec{G}_1^{L_1} \cdot \vec{G}_2^{L_2^{-1}} \right) \\ &= \lim_{t \rightarrow t_0} \left( \vec{G}_1 \setminus \vec{G}_2 \right)^{L_1} \left( \vec{G}_1 \cap \vec{G}_2 \right)^{L_1 \cdot L_2^{-1}} \left( \vec{G}_2 \setminus \vec{G}_1 \right)^{L_2} \\ &= \lim_{t \rightarrow t_0} \left( \vec{G}_1 \cap \vec{G}_2 \right)^{L_1 \cdot L_2^{-1}} = \lim_{t \rightarrow t_0} \left( \vec{G}_1 \cap \vec{G}_2 \right)^{\frac{L_1}{L_2^{-1}}} \\ &= \left( \vec{G}_1 \cap \vec{G}_2 \right)^{\lim_{t \rightarrow t_0} \frac{L_1}{L_2^{-1}}} = \left( \vec{G}_1 \cap \vec{G}_2 \right)^{\frac{\lim_{t \rightarrow t_0} L'_1}{\lim_{t \rightarrow t_0} L'_2^{-1}}} \\ &= \left( \vec{G}_1 \setminus \vec{G}_2 \right)^{\lim_{t \rightarrow t_0} L'_1} \left( \vec{G}_1 \cap \vec{G}_2 \right)^{\lim_{t \rightarrow t_0} L'_1} \cdot \lim_{t \rightarrow t_0} L'_2^{-1} \left( \vec{G}_2 \setminus \vec{G}_1 \right)^{\lim_{t \rightarrow t_0} L'_2} \\ &= \vec{G}_1^{\lim_{t \rightarrow t_0} L'_1} \cdot \vec{G}_2^{\lim_{t \rightarrow t_0} L'_2^{-1}} = \frac{\lim_{t \rightarrow t_0} \vec{G}_1^{L'_1}}{\lim_{t \rightarrow t_0} \vec{G}_2^{L'_2}}.\end{aligned}$$

This completes the proof.  $\square$

**Corollary 3.6** *If  $\lim_{t \rightarrow t_0} \vec{G}^{L_1} = \mathbf{O}$ ,  $\lim_{t \rightarrow t_0} \vec{G}^{L_2} = \mathbf{O}$  and  $L_1, L_2$  are differentiable respect to  $t$  with  $\lim_{t \rightarrow t_0} L'_2(v, u) \neq 0$  for  $(v, u) \in E(\vec{G})$ , then*

$$\lim_{t \rightarrow t_0} \left( \frac{\vec{G}^{L_1}}{\vec{G}^{L_2}} \right) = \frac{\lim_{t \rightarrow t_0} \vec{G}^{L'_1}}{\lim_{t \rightarrow t_0} \vec{G}^{L'_2}}.$$

Generally, by Taylor formula

$$\vec{G}^L = \vec{G}^{L(t_0)} + \frac{t - t_0}{1!} \vec{G}^{L'(t_0)} + \dots + \frac{(t - t_0)^k}{k!} \vec{G}^{L^{(k)}(t_0)} + o\left((t - t_0)^{-k} \vec{G}\right),$$

if  $L_1(t_0) = L'_1(t_0) = \dots = L_1^{(k-1)}(t_0) = 0$  and  $L_2(t_0) = L'_2(t_0) = \dots = L_2^{(k-1)}(t_0) = 0$  but  $L_2^{(k)}(t_0) \neq 0$ , then

$$\begin{aligned} \vec{G}_1^{L_1} &= \frac{(t - t_0)^k}{k!} \vec{G}_1^{L_1^{(k)}(t_0)} + o\left((t - t_0)^{-k} \vec{G}_1\right), \\ \vec{G}_2^{L_2} &= \frac{(t - t_0)^k}{k!} \vec{G}_2^{L_2^{(k)}(t_0)} + o\left((t - t_0)^{-k} \vec{G}_2\right). \end{aligned}$$

We are easily know the following result.

**Theorem 3.7** *If  $\lim_{t \rightarrow t_0} \vec{G}_1^{L_1} = \mathbf{O}$ ,  $\lim_{t \rightarrow t_0} \vec{G}_2^{L_2} = \mathbf{O}$  and  $L_1(t_0) = L'_1(t_0) = \dots = L_1^{(k-1)}(t_0) = 0$  and  $L_2(t_0) = L'_2(t_0) = \dots = L_2^{(k-1)}(t_0) = 0$  but  $L_2^{(k)}(t_0) \neq 0$ , then*

$$\lim_{t \rightarrow t_0} \frac{\vec{G}_1^{L_1}}{\vec{G}_2^{L_2}} = \frac{\lim_{t \rightarrow t_0} \vec{G}_1^{L_1^{(k)}(t_0)}}{\lim_{t \rightarrow t_0} \vec{G}_2^{L_2^{(k)}(t_0)}}.$$

**Example 3.8** Let  $\vec{G}_1 = \vec{G}_2 = \vec{C}_n$ ,  $A_{v_i v_{i+1}}^+ = 1$ ,  $A_{v_i v_{i-1}}^+ = 2$  and

$$f_i = \frac{f_1 + (2^{i-1} - 1) F(\bar{x})}{2^{i-1}} + \frac{n!}{(2n + 1)e^t}$$

for integers  $1 \leq i \leq n$  in Fig.4.

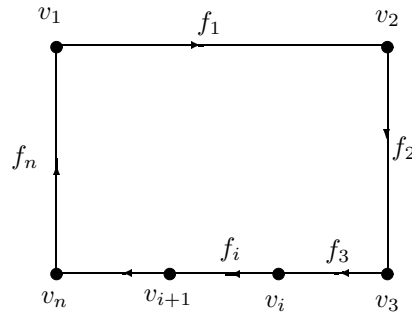

**Fig.4**



*Proof* Clearly, if (4.1) is solvable, then for  $\forall(v, u) \in E(\vec{G})$ , the linear equations

$$\begin{cases} x_1L_{11}(v, u) + x_2L_{12}(v, u) + \cdots + x_nL_{n1}(v, u) = L_1(v, u) \\ x_1L_{21}(v, u) + x_2L_{22}(v, u) + \cdots + x_nL_{2n}(v, u) = L_2(v, u) \\ \dots\dots\dots \\ x_1L_{n1}(v, u) + x_2L_{n2}(v, u) + \cdots + x_nL_{nn}(v, u) = L_n(v, u) \end{cases}$$

is solvable. By linear algebra, there must be

$$\text{Rank} \begin{pmatrix} L_{11}(v, u) & L_{12}(v, u) & \cdots & L_{1n}(v, u) \\ L_{21}(v, u) & L_{22}(v, u) & \cdots & L_{2n}(v, u) \\ \dots & \dots & \dots & \dots \\ L_{n1}(v, u) & L_{n2}(v, u) & \cdots & L_{nn}(v, u) \end{pmatrix} = \text{Rank} \begin{pmatrix} L_{11}(v, u) & L_{12}(v, u) & \cdots & L_{1n}(v, u) & L_1(v, u) \\ L_{21}(v, u) & L_{22}(v, u) & \cdots & L_{2n}(v, u) & L_2(v, u) \\ \dots & \dots & \dots & \dots & \dots \\ L_{n1}(v, u) & L_{n2}(v, u) & \cdots & L_{nn}(v, u) & L_n(v, u) \end{pmatrix},$$

which implies that

$$\vec{G}\text{Rank}[L] = \vec{G}\text{Rank}[L].$$

Conversely, if the (4.2) is hold, then for  $\forall(v, u) \in E(\vec{G})$ , the linear equations

$$\begin{cases} x_1L_{11}(v, u) + x_2L_{12}(v, u) + \cdots + x_nL_{n1}(v, u) = L_1(v, u) \\ x_1L_{21}(v, u) + x_2L_{22}(v, u) + \cdots + x_nL_{2n}(v, u) = L_2(v, u) \\ \dots\dots\dots \\ x_1L_{n1}(v, u) + x_2L_{n2}(v, u) + \cdots + x_nL_{nn}(v, u) = L_n(v, u) \end{cases}$$

is solvable, i.e., the equations (4.1) is solvable. □

**Theorem 4.2** *A continuity flow equation*

$$\lambda^s \vec{G}^{L_s} + \lambda^{s-1} \vec{G}^{L_{s-1}} + \cdots + \vec{G}^{L_0} = \mathbf{0} \tag{4.3}$$

always has solutions  $\vec{G}^{L_\lambda}$  with  $L_\lambda : (v, u) \in E(\vec{G}) \rightarrow \{\lambda_1^{vu}, \lambda_2^{vu}, \dots, \lambda_s^{vu}\}$ , where  $\lambda_i^{vu}, 1 \leq i \leq s$  are roots of the equation

$$\alpha_s^{vu} \lambda^s + \alpha_{s-1}^{vu} \lambda^{s-1} + \cdots + \alpha_0^{vu} = 0 \tag{4.4}$$

with  $L_i : (v, u) \rightarrow \alpha_i^{vu}$ ,  $\alpha_s^{vu} \neq 0$  a constant for  $(v, u) \in E(\vec{G})$  and  $1 \leq i \leq s$ .

For  $(v, u) \in E(\vec{G})$ , if  $n^{vu}$  is the maximum number  $i$  with  $L_i(v, u) \neq 0$ , then there are



$\prod_{(v,u) \in E(\vec{G})} n^{vu}$  solutions  $\vec{G}^{L_\lambda}$ , and particularly, if  $L_s(v, u) \neq 0$  for  $\forall (v, u) \in E(\vec{G})$ , there are  $s^{|E(\vec{G})|}$  solutions  $\vec{G}^{L_\lambda}$  of equation (4.3).

*Proof* By the fundamental theorem of algebra, we know there are  $s$  roots  $\lambda_1^{vu}, \lambda_2^{vu}, \dots, \lambda_s^{vu}$  for the equation (4.3). Whence,  $L_\lambda \vec{G}$  is a solution of equation (4.2) because of

$$\begin{aligned} & (\lambda \vec{G})^s \cdot \vec{G}^{L_s} + (\lambda \vec{G})^{s-1} \cdot \vec{G}^{L_{s-1}} + \dots + (\lambda \vec{G})^0 \cdot \vec{G}^{L_0} \\ &= \vec{G}^{\lambda^s L_s} + \vec{G}^{\lambda^{s-1} L_{s-1}} + \dots + \vec{G}^{\lambda^0 L_0} = \vec{G}^{\lambda^s L_s + \lambda^{s-1} L_{s-1} + \dots + L_0} \end{aligned}$$

and

$$\lambda^s L_s + \lambda^{s-1} L_{s-1} + \dots + L_0 : (v, u) \rightarrow \alpha_s^{vu} \lambda^s + \alpha_{s-1}^{vu} \lambda^{s-1} + \dots + \alpha_0^{vu} = 0,$$

for  $\forall (v, u) \in E(\vec{G})$ , i.e.,

$$(\lambda \vec{G})^s \cdot \vec{G}^{L_s} + (\lambda \vec{G})^{s-1} \cdot \vec{G}^{L_{s-1}} + \dots + (\lambda \vec{G})^0 \cdot \vec{G}^{L_0} = 0 \vec{G} = \mathbf{O}.$$

Count the number of different  $L_\lambda$  for  $(v, u) \in E(\vec{G})$ . It is nothing else but just  $n^{vu}$ . Therefore, the number of solutions of equation (4.3) is  $\prod_{(v,u) \in E(\vec{G})} n^{vu}$ .  $\square$

**Theorem 4.3** *A continuity flow equation*

$$\frac{d\vec{G}^L}{dt} = \vec{G}^{L_\alpha} \cdot \vec{G}^L \quad (4.5)$$

with initial values  $\vec{G}^L \Big|_{t=0} = \vec{G}^{L_\beta}$  always has a solution

$$\vec{G}^L = \vec{G}^{L_\beta} \cdot \left( e^{tL_\alpha} \vec{G} \right),$$

where  $L_\alpha : (v, u) \rightarrow \alpha_{vu}$ ,  $L_\beta : (v, u) \rightarrow \beta_{vu}$  are constants for  $\forall (v, u) \in E(\vec{G})$ .

*Proof* A calculation shows that

$$\vec{G} \frac{dL}{dt} = \frac{d\vec{G}^L}{dt} = \vec{G}^{L_\alpha} \cdot \vec{G}^L = \vec{G}^{L_\alpha \cdot L},$$

which implies that

$$\frac{dL}{dt} = \alpha_{vu} L \quad (4.6)$$

for  $\forall (v, u) \in E(\vec{G})$ .

Solving equation (4.6) enables one knowing that  $L(v, u) = \beta_{vu} e^{t\alpha_{vu}}$  for  $\forall (v, u) \in E(\vec{G})$ .

Whence, the solution of (4.5) is

$$\vec{G}^L = \vec{G}^{L_\beta} e^{tL_\alpha} = \vec{G}^{L_\beta} \cdot \left( e^{tL_\alpha} \vec{G} \right)$$

and conversely, by Theorem 3.2,

$$\begin{aligned} \frac{d\vec{G}^{L_\beta} e^{tL_\alpha}}{dt} &= \vec{G}^{L_\beta} \frac{d(L_\beta e^{tL_\alpha})}{dt} = \vec{G}^{L_\beta} L_\alpha L_\beta e^{tL_\alpha} \\ &= \vec{G}^{L_\alpha} \cdot \vec{G}^{L_\beta} e^{tL_\alpha}, \end{aligned}$$

i.e.,

$$\frac{d\vec{G}^L}{dt} = \vec{G}^{L_\alpha} \cdot \vec{G}^L$$

if  $\vec{G}^L = \vec{G}^{L_\beta} \cdot \left( e^{tL_\alpha} \vec{G} \right)$ . This completes the proof.  $\square$

Theorem 4.3 can be generalized to the case of  $L : (v, u) \rightarrow \mathbb{R}^n, n \geq 2$  for  $\forall (v, u) \in E(\vec{G})$ .

**Theorem 4.4** *A complex flow equation*

$$\frac{d\vec{G}^L}{dt} = \vec{G}^{L_\alpha} \cdot \vec{G}^L \quad (4.7)$$

with initial values  $\vec{G}^L|_{t=0} = \vec{G}^{L_\beta}$  always has a solution

$$\vec{G}^L = \vec{G}^{L_\beta} \cdot \left( e^{tL_\alpha} \vec{G} \right),$$

where  $L_\alpha : (v, u) \rightarrow (\alpha_{vu}^1, \alpha_{vu}^2, \dots, \alpha_{vu}^n)$ ,  $L_\beta : (v, u) \rightarrow (\beta_{vu}^1, \beta_{vu}^2, \dots, \beta_{vu}^n)$  with constants  $\alpha_{vu}^i, \beta_{vu}^i, 1 \leq i \leq n$  for  $\forall (v, u) \in E(\vec{G})$ .

**Theorem 4.5** *A complex flow equation*

$$\vec{G}^{L_{\alpha_n}} \cdot \frac{d^n \vec{G}^L}{dt^n} + \vec{G}^{L_{\alpha_{n-1}}} \cdot \frac{d^{n-1} \vec{G}^L}{dt^{n-1}} + \dots + \vec{G}^{L_{\alpha_0}} \cdot \vec{G}^L = \mathbf{0} \quad (4.8)$$

with  $L_{\alpha_i} : (v, u) \rightarrow \alpha_i^{vu}$  constants for  $\forall (v, u) \in E(\vec{G})$  and integers  $0 \leq i \leq n$  always has a general solution  $\vec{G}^{L_\lambda}$  with

$$L_\lambda : (v, u) \rightarrow \left\{ 0, \sum_{i=1}^s h_i(t) e^{\lambda_i^{vu} t} \right\}$$

for  $(v, u) \in E(\vec{G})$ , where  $h_{m_i}(t)$  is a polynomial of degree  $\leq m_i - 1$  on  $t$ ,  $m_1 + m_2 + \dots + m_s = n$  and  $\lambda_1^{vu}, \lambda_2^{vu}, \dots, \lambda_s^{vu}$  are the distinct roots of characteristic equation

$$\alpha_n^{vu} \lambda^n + \alpha_{n-1}^{vu} \lambda^{n-1} + \dots + \alpha_0^{vu} = 0$$

with  $\alpha_n^{vu} \neq 0$  for  $(v, u) \in E(\vec{G})$ .

*Proof* Clearly, the equation (4.8) on an edge  $(v, u) \in E(\vec{G})$  is

$$\alpha_n^{vu} \frac{d^n L(v, u)}{dt^n} + \alpha_{n-1}^{vu} \frac{d^{n-1} L(v, u)}{dt^{n-1}} + \dots + \alpha_0 = 0. \tag{4.9}$$

As usual, assuming the solution of (4.6) has the form  $\vec{G}^L = e^{\lambda t} \vec{G}$ . Calculation shows that

$$\begin{aligned} \frac{d\vec{G}^L}{dt} &= \lambda e^{\lambda t} \vec{G} = \lambda \vec{G}, \\ \frac{d^2 \vec{G}^L}{dt^2} &= \lambda^2 e^{\lambda t} \vec{G} = \lambda^2 \vec{G}, \\ &\dots \dots \dots, \\ \frac{d^n \vec{G}^L}{dt^n} &= \lambda^n e^{\lambda t} \vec{G} = \lambda^n \vec{G}. \end{aligned}$$

Substituting these calculation results into (4.8), we get that

$$\left( \lambda^n \vec{G}^{L\alpha_n} + \lambda^{n-1} \vec{G}^{L\alpha_{n-1}} + \dots + \vec{G}^{L\alpha_0} \right) \cdot \vec{G}^L = \mathbf{0},$$

i.e.,

$$\vec{G}^{(\lambda^n \cdot L\alpha_n + \lambda^{n-1} \cdot L\alpha_{n-1} + \dots + L\alpha_0) \cdot L} = \mathbf{0},$$

which implies that for  $\forall (v, u) \in E(\vec{G})$ ,

$$\lambda^n \alpha_n^{vu} + \lambda^{n-1} \alpha_{n-1}^{vu} + \dots + \alpha_0 = 0 \tag{4.10}$$

or

$$L(v, u) = 0.$$

Let  $\lambda_1^{vu}, \lambda_2^{vu}, \dots, \lambda_s^{vu}$  be the distinct roots with respective multiplicities  $m_1^{vu}, m_2^{vu}, \dots, m_s^{vu}$  of equation (4.8). We know the general solution of (4.9) is

$$L(v, u) = \sum_{i=1}^s h_i(t) e^{\lambda_i^{vu} t}$$

with  $h_{m_i}(t)$  a polynomial of degree  $\leq m_i - 1$  on  $t$  by the theory of ordinary differential equations. Therefore, the general solution of (4.8) is  $\vec{G}^{L\lambda}$  with

$$L_\lambda : (v, u) \rightarrow \left\{ 0, \sum_{i=1}^s h_i(t) e^{\lambda_i^{vu} t} \right\}$$

for  $(v, u) \in E(\vec{G})$ . □

### §5. Complex Flow with Continuity Flows

The difference of a complex flow  $\vec{G}^L$  with that of a continuity flow  $\vec{G}^L$  is the labeling  $L$  on a vertex is  $L(v) = \dot{x}_v$  or  $x_v$ . Notice that

$$\frac{d}{dt} \left( \sum_{u \in N_G(v)} L^{A_{vu}^+}(v, u) \right) = \sum_{u \in N_G(v)} \frac{d}{dt} L^{A_{vu}^+}(v, u)$$

for  $\forall v \in V(\vec{G})$ . There must be relations between complex flows  $\vec{G}^L$  and continuity flows  $\vec{G}^L$ . We get a general result following.

**Theorem 5.1** *If end-operators  $A_{vu}^+$ ,  $A_{uv}^+$  are linear with  $\left[ \int_0^t, A_{vu}^+ \right] = \left[ \int_0^t, A_{uv}^+ \right] = \mathbf{0}$  and  $\left[ \frac{d}{dt}, A_{vu}^+ \right] = \left[ \frac{d}{dt}, A_{uv}^+ \right] = \mathbf{0}$  for  $\forall (v, u) \in E(\vec{G})$ , and particularly,  $A_{vu}^+ = \mathbf{1}_\gamma$ , then  $\vec{G}^L \in \langle \vec{G}_i, 1 \leq i \leq n \rangle_{\mathbb{R} \times \mathbb{R}^n}$  is a continuity flow with a constant  $L(v)$  for  $\forall v \in V(\vec{G})$  if and only if  $\int_0^t \vec{G}^L dt$  is such a continuity flow with a constant one each vertex  $v$ ,  $v \in V(\vec{G})$ .*

*Proof* Notice that if  $A_{vu}^+ = \mathbf{1}_\gamma$ , there always is  $\left[ \int_0^t, A_{vu}^+ \right] = \mathbf{0}$  and  $\left[ \frac{d}{dt}, A_{vu}^+ \right] = \mathbf{0}$ , and by definition, we know that

$$\begin{aligned} \left[ \int_0^t, A_{vu}^+ \right] = \mathbf{0} &\Leftrightarrow \int_0^t \circ A_{vu}^+ = A_{vu}^+ \circ \int_0^t, \\ \left[ \frac{d}{dt}, A_{vu}^+ \right] = \mathbf{0} &\Leftrightarrow \frac{d}{dt} \circ A_{vu}^+ = A_{vu}^+ \circ \frac{d}{dt}. \end{aligned}$$

If  $\vec{G}^L$  is a continuity flow with a constant  $L(v)$  for  $\forall v \in V(\vec{G})$ , i.e.,

$$\sum_{u \in N_G(v)} L^{A_{vu}^+}(v, u) = \mathbf{v} \quad \text{for } \forall v \in V(\vec{G}),$$

we are easily know that

$$\begin{aligned} \int_0^t \left( \sum_{u \in N_G(v)} L^{A_{vu}^+}(v, u) \right) dt &= \sum_{u \in N_G(v)} \left( \int_0^t \circ A_{vu}^+ \right) L(v, u) dt = \sum_{u \in N_G(v)} \left( A_{vu}^+ \circ \int_0^t \right) L(v, u) dt \\ &= \sum_{u \in N_G(v)} A_{vu}^+ \left( \int_0^t L(v, u) dt \right) = \int_0^t \mathbf{v} dt \end{aligned}$$

for  $\forall v \in V(\vec{G})$  with a constant vector  $\int_0^t \mathbf{v} dt$ , i.e.,  $\int_0^t \vec{G}^L dt$  is a continuity flow with a constant flow on each vertex  $v$ ,  $v \in V(\vec{G})$ .

Conversely, if  $\int_0^t \vec{G}^L dt$  is a continuity flow with a constant flow on each vertex  $v$ ,  $v \in$

$V(\vec{G})$ , i.e.,

$$\sum_{u \in N_G(v)} A_{vu}^+ \circ \int_0^t L(v, u) dt = \mathbf{v} \quad \text{for } \forall v \in V(\vec{G}),$$

then

$$\vec{G}^L = \frac{d \left( \int_0^t \vec{G}^L dt \right)}{dt}$$

is such a continuity flow with a constant flow on vertices in  $\vec{G}$  because of

$$\begin{aligned} \frac{d \left( \sum_{u \in N_G(v)} L^{A_{vu}^+}(v, u) \right)}{dt} &= \sum_{u \in N_G(v)} \frac{d}{dt} \circ A_{vu}^+ \circ \int_0^t L(v, u) dt \\ &= \sum_{u \in N_G(v)} A_{vu}^+ \circ \frac{d}{dt} \circ \int_0^t L(v, u) dt = \sum_{u \in N_G(v)} L(v, u)^{A_{vu}^+} = \frac{d\mathbf{v}}{dt} \end{aligned}$$

with a constant flow  $\frac{d\mathbf{v}}{dt}$  on vertex  $v$ ,  $v \in V(\vec{G})$ . This completes the proof.  $\square$

If all end-operators  $A_{vu}^+$  and  $A_{uv}^+$  are constant for  $\forall(v, u) \in E(\vec{G})$ , the conditions  $\left[ \int_0^t, A_{vu}^+ \right] = \left[ \int_0^t, A_{uv}^+ \right] = \mathbf{0}$  and  $\left[ \frac{d}{dt}, A_{vu}^+ \right] = \left[ \frac{d}{dt}, A_{uv}^+ \right] = \mathbf{0}$  are clearly true. We immediately get a conclusion by Theorem 5.1 following.

**Corollary 5.2** For  $\forall(v, u) \in E(\vec{G})$ , if end-operators  $A_{vu}^+$  and  $A_{uv}^+$  are constant  $c_{vu}$ ,  $c_{uv}$  for  $\forall(v, u) \in E(\vec{G})$ , then  $\vec{G}^L \in \langle \vec{G}_i, 1 \leq i \leq n \rangle^{\mathbb{R} \times \mathbb{R}^n}$  is a continuity flow with a constant  $L(v)$  for  $\forall v \in V(\vec{G})$  if and only if  $\int_0^t \vec{G}^L dt$  is such a continuity flow with a constant flow on each vertex  $v$ ,  $v \in V(\vec{G})$ .

## References

- [1] R.Abraham and J.E.Marsden, *Foundation of Mechanics* (2nd edition), Addison-Wesley, Reading, Mass, 1978.
- [2] Fred Brauer and Carlos Castillo-Chaver, *Mathematical Models in Population Biology and Epidemiology*(2nd Edition), Springer, 2012.
- [3] G.R.Chen, X.F.Wang and X.Li, *Introduction to Complex Networks – Models, Structures and Dynamics* (2 Edition), Higher Education Press, Beijing, 2015.
- [4] John B.Conway, *A Course in Functional Analysis*, Springer-Verlag New York,Inc., 1990.
- [5] Y.Lou, Some reaction diffusion models in spatial ecology (in Chinese), *Sci.Sin. Math.*, Vol.45(2015), 1619-1634.
- [6] Linfan Mao, *Automorphism Groups of Maps, Surfaces and Smarandache Geometries*, The

- Education Publisher Inc., USA, 2011.
- [7] Linfan Mao, *Smarandache Multi-Space Theory*, The Education Publisher Inc., USA, 2011.
  - [8] Linfan Mao, *Combinatorial Geometry with Applications to Field Theory*, The Education Publisher Inc., USA, 2011.
  - [9] Linfan Mao, Global stability of non-solvable ordinary differential equations with applications, *International J.Math. Combin.*, Vol.1 (2013), 1-37.
  - [10] Linfan Mao, Non-solvable equation systems with graphs embedded in  $\mathbf{R}^n$ , *Proceedings of the First International Conference on Smarandache Multispace and Multistructure*, The Education Publisher Inc. July, 2013.
  - [11] Linfan Mao, Geometry on  $G^L$ -systems of homogenous polynomials, *International J.Contemp. Math. Sciences*, Vol.9 (2014), No.6, 287-308.
  - [12] Linfan Mao, Mathematics on non-mathematics - A combinatorial contribution, *International J.Math. Combin.*, Vol.3(2014), 1-34.
  - [13] Linfan Mao, Cauchy problem on non-solvable system of first order partial differential equations with applications, *Methods and Applications of Analysis*, Vol.22, 2(2015), 171-200.
  - [14] Linfan Mao, Extended Banach  $\vec{G}$ -flow spaces on differential equations with applications, *Electronic J.Mathematical Analysis and Applications*, Vol.3, No.2 (2015), 59-91.
  - [15] Linfan Mao, A new understanding of particles by  $\vec{G}$ -flow interpretation of differential equation, *Progress in Physics*, Vol.11(2015), 193-201.
  - [16] Linfan Mao, A review on natural reality with physical equation, *Progress in Physics*, Vol.11(2015), 276-282.
  - [17] Linfan Mao, Mathematics with natural reality-action flows, *Bull.Cal.Math.Soc.*, Vol.107, 6(2015), 443-474.
  - [18] Linfan Mao, Labeled graph – A mathematical element, *International J.Math. Combin.*, Vol.3(2016), 27-56.
  - [19] Linfan Mao, Biological  $n$ -system with global stability, *Bull.Cal.Math.Soc.*, Vol.108, 6(2016), 403-430.
  - [20] J.D.Murray, *Mathematical Biology I: An Introduction* (3rd Edition), Springer-Verlag Berlin Heidelberg, 2002.
  - [21] F.Smarandache, *Paradoxist Geometry*, State Archives from Valcea, Rm. Valcea, Romania, 1969, and in *Paradoxist Mathematics*, Collected Papers (Vol. II), Kishinev University Press, Kishinev, 5-28, 1997.
  - [22] J.Stillwell, *Classical Topology and Combinatorial Group Theory*, Springer-Verlag, New York, 1980.

## Labeled Graph – A Mathematical Element

**Abstract:** The universality of contradiction and connection of things in nature implies that a thing is nothing else but a labeled topological graph  $G^L$  with a labeling map  $L : V(G) \cup E(G) \rightarrow \mathcal{L}$  in space, which concludes also that labeled graph should be an element for understanding things in the world. This fact proposes 2 directions on labeled graphs: (1) verify a graph family  $\mathcal{G}$  whether or not they can be labeled by a labeling  $L$  constraint on special conditions, and (2) establish mathematical systems such as those of groups, rings, linear spaces or Banach spaces over graph  $G$ , i.e., view labeled graphs  $G^L$  as elements of that system. However, all results on labeled graphs are nearly concentrated on the first in past decades, which is in fact searching structure  $G$  of the labeling set  $\mathcal{L}$ . The main purpose of this survey is to show the role of labeled graphs in extending mathematical systems over graphs  $G$ , particularly graphical tensors and  $\vec{G}$ -flows with conservation laws and applications to physics and other sciences such as those of labeled graphs with sets or Euclidean spaces  $\mathbb{R}^n$  labeling, labeled graph solutions of non-solvable systems of differential equations with global stability and extended Banach or Hilbert  $\vec{G}$ -flow spaces. All of these makes it clear that holding on the reality of things by classical mathematics is partial or local, only on the coherent behaviors of things for itself homogenous without contradictions, but the mathematics over graphs  $G$  is applicable for contradictory systems over  $G$  because contradiction is universal in the nature, which can turn a contradictory system to a compatible one, i.e., mathematical combinatorics.

**Key Words:** Topological graph, labeling, group, linear space, Banach space, Smarandache multispace, non-solvable equation, graphical tensor,  $\vec{G}$ -flow, mathematical combinatorics.

**AMS(2010):** 03A10,05C15,20A05, 34A26,35A01,51A05,51D20,53A35.

### §1. Introduction

Just as the philosophical question on human beings: *where we come from, and where to go?* There is also a question on our world: *Is our world continuous or discrete?* Different peoples with different world views will answer this question differently, particularly for researchers on continuous or discrete sciences, for instance, the fluid mechanics or elementary particles with interactions. Actually, a natural thing  $T$  is complex, ever hybrid with other things on the eyes of human beings sometimes. Thus, holding on the true face of thing  $T$  is difficult, maybe result in disputation for persons standing on different views or positions for  $T$ , which also implies that all contradictions are man made, not the nature of things. For this fact, a typical example was

---

<sup>1</sup>A plenary report at the *4th International Conference on Discrete Mathematics and Graph Theory Day-XII*, June 10-11, 2016, Bangalore, India.

<sup>2</sup>*International J.Math.Combin*, Vol.3(2016), 27-56.

shown once by the famous fable “the blind men with an elephant”. In this fable, there are six blind men were asked to determine what an elephant looked like by feeling different parts of the elephant’s body. The man touched the elephant’s leg, tail, trunk, ear, belly or tusk respectively claims it’s like a pillar, a rope, a tree branch, a hand fan, a wall or a solid pipe, such as those shown in Fig.1 following. Each of them insisted on his own and not accepted others. They then entered into an endless argument.



Fig.1

All of you are right! A wise man explains to them: *why are you telling it differently is because each one of you touched the different part of the elephant. So, actually the elephant has all those features what you all said.*

Thus, the best result on an elephant for these blind men is

$$\begin{aligned} \text{An elephant} &= \{4 \text{ pillars}\} \cup \{1 \text{ rope}\} \cup \{1 \text{ tree branch}\} \\ &\cup \{2 \text{ hand fans}\} \cup \{1 \text{ wall}\} \cup \{1 \text{ solid pipe}\} \end{aligned}$$

A thing  $T$  is usually identified with known characters on it at one time, and this process is advanced gradually by ours. For example, let  $\mu_1, \mu_2, \dots, \mu_n$  be the known and  $\nu_i, i \geq 1$  the unknown characters at time  $t$ . Then, the thing  $T$  is understood by

$$T = \left( \bigcup_{i=1}^n \{\mu_i\} \right) \cup \left( \bigcup_{k \geq 1} \{\nu_k\} \right) \quad (1.1)$$

in logic and with an approximation  $T^\circ = \bigcup_{i=1}^n \{\mu_i\}$  at time  $t$ . Particularly, *how can the wise man tell these blind men the visual image of an elephant in fable of the blind men with an elephant?* If the wise man is a discrete mathematician, he would tell the blind men that an elephant looks like nothing else but a labeled tree shown in Fig.2.



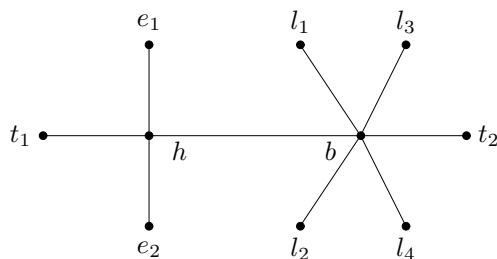

Fig.2

where,  $\{t_1\}$  =tusk,  $\{e_1, e_2\}$  =ears,  $\{h\}$  =head,  $\{b\}$  =belly,  $\{l_1, l_2, l_3, l_4\}$  =legs and  $\{t_2\}$  =tail. Hence, labeled graphs are elements for understanding things of the world in our daily life. *What is the philosophical meaning of this fable for understanding things in the world?* It lies in that the situation of human beings knowing things in the world is analogous to these blind men. We can only hold on things by canonical model (1.1), or the labeled tree in Fig.2.

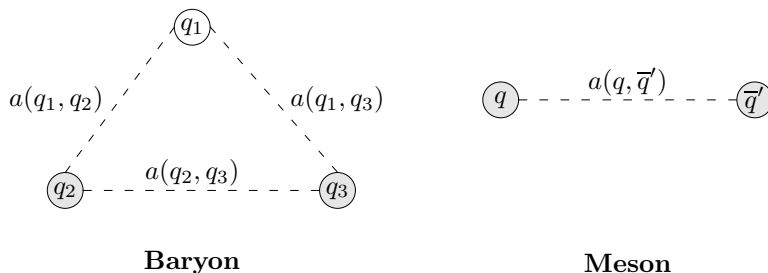

Fig.3

Notice that the elementary particle theory is indeed a discrete notion on matters in the nature. For example, a baryon is predominantly formed from three quarks, and a meson is mainly composed of a quark and an antiquark in the quark models of Sakata, or Gell-Mann and Ne’eman ([27], [32]) such as those shown in Fig.3, which are nothing else but both multiverses ([3]), or graphs labeled by quark  $q_i \in \{\mathbf{u}, \mathbf{d}, \mathbf{c}, \mathbf{s}, \mathbf{t}, \mathbf{b}\}$  for  $i = 1, 2, 3$  and antiquark  $\bar{q}' \in \{\bar{\mathbf{u}}, \bar{\mathbf{d}}, \bar{\mathbf{c}}, \bar{\mathbf{s}}, \bar{\mathbf{t}}, \bar{\mathbf{b}}\}$ , where  $a(q, q')$  denotes the strength between quarks  $q$  and  $q'$ .

Certainly, a natural thing can not exist out of the live space, the universe. Thus, the labeled graphs in Fig.2 and 3 are actually embedded in the Euclidean space  $\mathbb{R}^3$ , i.e. a labeled topological graph. Generally, a topological graph  $\varphi(G)$  in a space  $\mathcal{S}$  is an embedding of  $\varphi : G \rightarrow \varphi(G) \subset \mathcal{S}$  with  $\varphi(p) \neq \varphi(q)$  if  $p \neq q$  for  $\forall p, q \in G$ , i.e., edges of  $G$  only intersect at vertices in  $\mathcal{S}$ . There is a well-known result on embedding of graphs without loops and multiple edges in  $\mathbb{R}^n$  for  $n \geq 3$  ([10]), i.e., *there always exists an embedding of  $G$  that all edges are straight segments in  $\mathbb{R}^n$ .*

Mathematically, a labeling on a graph  $G$  is a mapping  $L : V(G) \cup E(G) \rightarrow \mathcal{L}$  with a labeling set  $\mathcal{L}$  such as two labeled graphs on  $K_4$  with integers in  $\{1, 2, 3, 4\}$  shown in Fig.4, and they have been concentrated more attentions of researchers, particularly, the dynamical survey paper [4] first published in 1998. Usually,  $\mathcal{L}$  is chosen to be a segment of integers  $\mathbb{Z}$  and a labeling  $L : V(G) \rightarrow \mathcal{L}$  with constraints on edges in  $E(G)$ . Only on the journal: *International*

*Journal of Mathematical Combinatorics* in the past 9 years, we searched many papers on labeled graphs. For examples, the graceful, harmonic, Smarandache edge  $m$ -mean labeling ([29]) and quotient cordial labeling ([28]) are respectively with edge labeling  $|L(u) - L(v)|$ ,  $|L(u) + L(v)|$ ,  $\left\lceil \frac{f(u) + f(v)}{m} \right\rceil$  for  $m \geq 2$ ,  $\left\lceil \frac{f(u)}{f(v)} \right\rceil$  or  $\left\lceil \frac{f(v)}{f(u)} \right\rceil$  according  $f(u) \geq f(v)$  or  $f(v) > f(u)$  for  $\forall uv \in E(G)$ , and a Smarandache-Fibonacci or Lucas graceful labeling is such a labeling  $L : V(G) \rightarrow \{S(0), S(1), S(2), \dots, S(q)\}$  that the induced edge labeling is  $\{S(1), S(2), \dots, S(q)\}$  by  $L(uv) = |L(u) - L(v)|$  for  $\forall uv \in E(G)$  for a Smarandache-Fibonacci or Lucas sequence  $\{S(i), i \geq 1\}$  ([23]).

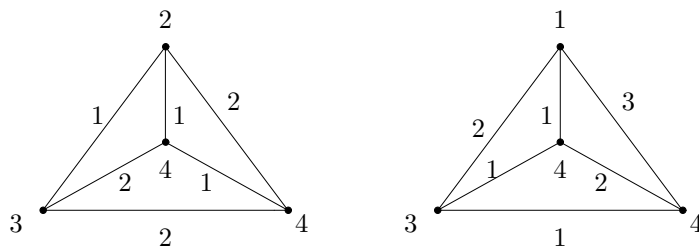

Fig.4

Similarly, an  $n$ -signed labeling is a  $n$ -tuple of  $\{-1, +1\}^n$  or  $\{0, 1\}$ -vector labeling on edges of graph  $G$  with  $|e_f(0) - e_f(1)| \leq 1$ , where  $e_f(0)$  and  $e_f(1)$  respectively denote the number of edges labeled with even integer or odd integer([26]), and a graceful set labeling is a labeling  $L : V(G) \rightarrow 2^X$  on vertices of  $G$  by subsets of a finite set  $X$  with induced edge labeling  $L(uv) = L(u) \oplus L(v)$  for  $\forall uv \in E(G)$ , where “ $\oplus$ ” denotes the binary operation of taking the symmetric difference of the sets in  $2^X$  ([30]). As a result, the combinatorial structures on  $\mathcal{L}$  were partially characterized.

However, for understanding things in the world we should ask ourself: *what are labels on a labeled graph, is it just different symbols? And are such labeled graphs a mechanism for understanding the reality of things, or only a labeling game?* Clearly, labeled graphs  $G$  considered by researchers are graphs mainly with number labeling, vector symbolic labeling without operation, or finite set labeling, and with an additional assumption that *each vertex of  $G$  is mapped exactly into one point of space  $\mathcal{S}$*  in topology. However, labels all are space objects in Fig.2 and 3. If we put off this assumption, i.e., labeling a topological graph by geometrical spaces, or elements with operations in a linear space, *what will happens? Are these resultants important for understanding things in the world?* The answer is certainly YES because this step will enable one to pullback more characters of things, characterize more precisely and then hold on the reality of things in the world, i.e., combines continuous mathematics with the discrete, which is nothing else but the *mathematical combinatorics*.

The main purpose of this report is to survey the role of labeled graphs in extending mathematical systems over graphs  $G$ , particularly graphical tensors and  $\vec{G}$ -flows with conservation laws and applications to mathematics, physics and other sciences such as those of labeled graphs with sets or Euclidean spaces  $\mathbb{R}^n$  labeling, labeled graph solutions of non-solvable systems of

differential equations with global stability, labeled graph with elements in a linear space, and extended Banach or Hilbert  $\vec{G}$ -flow spaces,  $\dots$ , etc. All of these makes it clear that holding on the reality of things by classical mathematics is partial, only on the coherent behaviors of things for itself homogenous without contradictions but the extended mathematics over graphs  $G$  can characterize contradictory systems, and accordingly can be applied to hold on the reality of things because contradiction is universal in the nature.

For terminologies and notations not mentioned here, we follow references [5] for functional analysis, [9]-[11] for graphs and combinatorial geometry, [2] for differential equations, [27] for elementary particles, and [1],[10] for Smarandache multispaces or multisystems.

**§2. Graphs Labeled by Sets**

Notice that the understanding form (1.1) of things is in fact a Smarandache multisystem following, which shows the importance of labeled graphs for things.

**Definition 2.1**([1],[10]) *Let  $(\Sigma_1; \mathcal{R}_1), (\Sigma_2; \mathcal{R}_2), \dots, (\Sigma_m; \mathcal{R}_m)$  be  $m$  mathematical systems, different two by two. A Smarandache multisystem  $\tilde{\Sigma}$  is a union  $\bigcup_{i=1}^m \Sigma_i$  with rules  $\tilde{\mathcal{R}} = \bigcup_{i=1}^m \mathcal{R}_i$  on  $\tilde{\Sigma}$ , denoted by  $(\tilde{\Sigma}; \tilde{\mathcal{R}})$ .*

**Definition 2.2**([9]-[11]) *For an integer  $m \geq 1$ , let  $(\tilde{\Sigma}; \tilde{\mathcal{R}})$  be a Smarandache multisystem consisting of  $m$  mathematical systems  $(\Sigma_1; \mathcal{R}_1), (\Sigma_2; \mathcal{R}_2), \dots, (\Sigma_m; \mathcal{R}_m)$ . An inherited combinatorial structure  $G^L[\tilde{\Sigma}; \tilde{\mathcal{R}}]$  of  $(\tilde{\Sigma}; \tilde{\mathcal{R}})$  is a labeled topological graph defined following:*

$$V(G^L[\tilde{\Sigma}; \tilde{\mathcal{R}}]) = \{\Sigma_1, \Sigma_2, \dots, \Sigma_m\},$$

$$E(G^L[\tilde{\Sigma}; \tilde{\mathcal{R}}]) = \{(\Sigma_i, \Sigma_j) | \Sigma_i \cap \Sigma_j \neq \emptyset, 1 \leq i \neq j \leq m\} \text{ with labeling}$$

$$L : \Sigma_i \rightarrow L(\Sigma_i) = \Sigma_i \quad \text{and} \quad L : (\Sigma_i, \Sigma_j) \rightarrow L(\Sigma_i, \Sigma_j) = \Sigma_i \cap \Sigma_j$$

for integers  $1 \leq i \neq j \leq m$ .

For example, let  $\Sigma_1 = \{a, b, c\}, \Sigma_2 = \{a, b, e\}, \Sigma_3 = \{b, c, e\}, \Sigma_4 = \{a, c, e\}$  and  $\mathcal{R}_i = \emptyset$  for integers  $1 \leq i \leq 4$ . The multisystem  $(\tilde{\Sigma}; \tilde{\mathcal{R}})$  with  $\tilde{\Sigma} = \bigcup_{i=1}^4 \Sigma_i = \{a, b, c, d, e\}$  and  $\tilde{\mathcal{R}} = \emptyset$  is characterized by the labeled topological graph  $G^L[\tilde{\Sigma}; \tilde{\mathcal{R}}]$  shown in Fig.5.

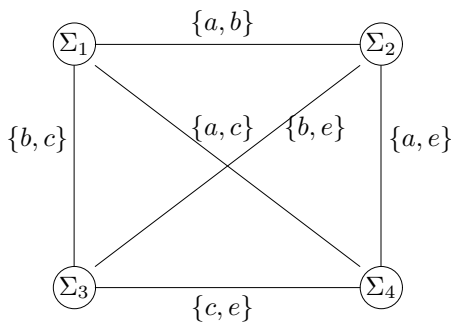

**Fig.5**

### 2.1 Exact Labeling

A multiset  $\tilde{S} = \bigcup_{i=1}^m S_i$  is *exact* if  $S_i = \bigcup_{j=1, j \neq i}^m (S_j \cap S_i)$  for any integer  $1 \leq i \leq m$ , i.e., for any vertex  $v \in V(G^L[\tilde{S}; \tilde{\mathcal{R}}])$ ,  $S_v = \bigcup_{u \in N_{G^L}(v)} (S_v \cap S_u)$  such as those shown in Fig.5. Clearly, a multiset  $\tilde{S}$  uniquely determines a labeled graph  $G^L$  by Definition 2.2, and conversely, if  $G^L$  is a graph labeled by sets, we are easily get an exact multiset

$$\tilde{S} = \bigcup_{v \in V(G^L)} S_v \quad \text{with} \quad S_v = \bigcup_{u \in N_{G^L}(v)} (S_v \cap S_u).$$

This concludes the following result.

**Theorem 2.3**([10]) *A multiset  $\tilde{S}$  uniquely determine a labeled graph  $G^L[\tilde{S}]$ , and conversely, any graph  $G^L$  labeled by sets uniquely determines an exact multiset  $\tilde{S}$ .*

All labeling sets on edges of graph in Fig.4 are 2-sets. Generally, we know

**Theorem 2.4** *For any graph  $G$ , if  $|S| \geq k\chi(G) \geq \Delta(G)\chi(G)$  or  $\binom{|S|}{k} \geq \chi'(G)$ , there is a labeling  $L$  with  $k$ -subset labels of  $S$  on all vertices or edges on  $G$ , where  $\varepsilon(G)$ ,  $\Delta(G)$ ,  $\chi(G)$  and  $\chi'(G)$  are respectively the size, the maximum valence, the chromatic number and the edge chromatic number of  $G$ .*

*Furthermore, if  $G$  is an  $s$ -regular graph, there exist integers  $k, l$  such that there is a labeling  $L$  on  $G$  with  $k$ -set,  $l$ -set labels on its vertices and edges, respectively.*

*Proof* Clearly, if  $\binom{|S|}{k} \geq \chi'(G)$ , we are easily find  $\chi'(G)$  different  $k$ -subsets  $C_1, C_2, \dots, C_{\chi'(G)}$  of  $S$  labeled on edges in  $G$ , and if  $|S| \geq k\chi(G) \geq \Delta(G)\chi(G)$ , there are  $\chi(G)$  different  $k$ -subsets  $C_1, C_2, \dots, C_{\chi(G)}$  of  $S$  labeled on vertices in  $G$  such that  $S_i \cap S_j = \emptyset$  or not if and only if  $uv \notin E(G)$  or not, where  $u$  and  $v$  are labeled by  $S_i$  and  $S_j$ , respectively.

Furthermore, if  $G$  is an  $s$ -regular graph, we can always allocate  $\chi'(G)$   $l$ -sets  $\{C_1, C_2, \dots, C_{\chi'(G)}\}$  with  $C_i \cap C_j = \emptyset$  for integers  $1 \leq i \neq j \leq \chi'(G)$  on edges in  $E(G)$  such that colors on adjacent edges are different, and then label vertices  $v$  in  $G$  by  $\bigcup_{u \in N_G(v)} C(vu)$ , which is a  $sl$ -set. The proof is complete for integer  $k = sl$ . □

### 2.2 Linear Space Labeling

Let  $(\tilde{V}; F)$  be a multilinear space consisting of subspaces  $V_i$ ,  $1 \leq i \leq |G|$  of linear space  $V$  over a field  $F$ . Such a multilinear space  $(\tilde{V}; F)$  is said to be *exact* if  $V_i = \bigoplus_{j \neq i} (V_i \cap V_j)$  holds for integers  $1 \leq i \leq n$ . According to linear algebra, two linear spaces  $V$  and  $V'$  over a field  $F$  are isomorphic if and only if  $\dim V = \dim V'$ , which enables one to characterize a vector  $V$  space by its basis  $\mathcal{B}(V)$  and label edges of  $G[\tilde{V}; F]$  by  $L : V_u V_v \rightarrow \mathcal{B}(V_u \cap V_v)$  for  $\forall V_u V_v \in E(G[\tilde{V}; F])$

in Definition 2.2 such as those shown in Fig.6.

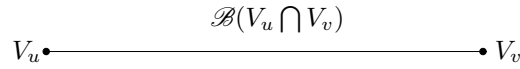

Fig.6

Clearly, if  $(\tilde{V}; F)$  is exact, i.e.,  $V_i = \bigoplus_{j \neq i} (V_i \cap V_j)$ , then it is clear that

$$\mathcal{B}(V) = \bigcup_{VV' \in E(G[\tilde{V}; F])} \mathcal{B}(V \cap V') \quad \text{and} \quad (\mathcal{B}(V \cap V')) \cap (\mathcal{B}(V \cap V'')) = \emptyset$$

by definition. Conversely, if

$$\mathcal{B}(V) = \bigcup_{VV' \in E(G[\tilde{V}; F])} \mathcal{B}(V \cap V') \quad \text{and} \quad \mathcal{B}(V \cap V') \cap \mathcal{B}(V \cap V'') = \emptyset$$

for  $V', V'' \in N_{G[\tilde{V}; F]}(V)$ . Notice also that  $VV' \in E(G[\tilde{V}; F])$  if and only if  $V \cap V' \neq \emptyset$ , we know that

$$V_i = \bigoplus_{j \neq i} (V_i \cap V_j)$$

for integers  $1 \leq i \leq n$ . This concludes the following result.

**Theorem 2.5**([10]) *Let  $(\tilde{V}; F)$  be a multilinear space with  $\tilde{V} = \bigcup_{i=1}^n V_i$ . Then it is exact if and only if*

$$\mathcal{B}(V) = \bigcup_{VV' \in E(G[\tilde{V}; F])} \mathcal{B}(V \cap V') \quad \text{and} \quad \mathcal{B}(V \cap V') \cap \mathcal{B}(V \cap V'') = \emptyset$$

for  $V', V'' \in N_{G[\tilde{V}; F]}(V)$ .

### 2.3 Euclidean Space Labeling

Let  $\mathbf{R}^n$  be a Euclidean space with normal basis  $\mathcal{B}(\mathbf{R}^n) = \{\bar{\epsilon}_1, \bar{\epsilon}_2, \dots, \bar{\epsilon}_n\}$ , where  $\bar{\epsilon}_1 = (1, 0, \dots, 0)$ ,  $\bar{\epsilon}_2 = (0, 1, 0, \dots, 0)$ ,  $\dots$ ,  $\bar{\epsilon}_n = (0, \dots, 0, 1)$  and let  $(\tilde{V}; F)$  be a multilinear space with  $\tilde{V} = \bigcup_{i=1}^m \mathbb{R}^{n_i}$  in Theorem 2.5, where  $\mathbb{R}^{n_i} \cap \mathbb{R}^{n_j} \neq \mathbb{R}^{\min\{i, j\}}$  for integers  $1 \leq i \neq j \leq m$ . If the labeled graph  $G[\tilde{V}; F]$  is known, we are easily determine the dimension of  $\dim \tilde{V}$ . For example, let  $G^L$  be a labeled graph shown in Fig.7. We are easily finding that  $\mathcal{B}(\tilde{\mathbf{R}}) = \{\bar{\epsilon}_1, \bar{\epsilon}_2, \bar{\epsilon}_3, \bar{\epsilon}_4, \bar{\epsilon}_5, \bar{\epsilon}_6\}$ , i.e.,  $\dim \tilde{V} = 6$ .

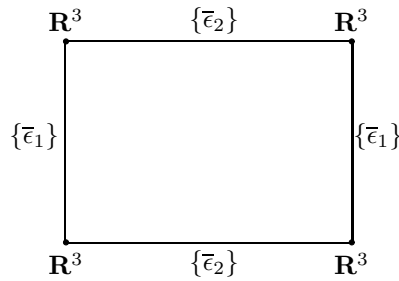

Fig.7

Notice that  $\tilde{V}$  is not exact in Fig.7 because basis  $\bar{\epsilon}_3, \bar{\epsilon}_4, \bar{\epsilon}_5, \bar{\epsilon}_6$  are additional. Generally, we are easily know the result by the inclusion-exclusion principle.

**Theorem 2.6**([8]) *Let  $G^L$  be a graph labeled by  $\mathbf{R}^{n_{v_1}}, \mathbf{R}^{n_{v_2}}, \dots, \mathbf{R}^{n_{|G|}}$ . Then*

$$\dim G^L = \sum_{\langle v_i \in V(G) | 1 \leq i \leq s \rangle \in CL_s(G)} (-1)^{s+1} \dim(\mathbf{R}^{n_{v_1}} \cap \mathbf{R}^{n_{v_2}} \cap \dots \cap \mathbf{R}^{n_{v_s}}),$$

where  $CL_s(G)$  consists of all complete graphs of order  $s$  in  $G^L$ .

However, if edge labelings  $\mathcal{B}(\mathbf{R}^{n_u} \cap \mathbf{R}^{n_v})$  are not known for  $uv \in E(G^L)$ , can we still determine the dimension  $\dim G^L$ ? In fact, we only get the maximum and minimum dimensions  $\dim_{max} G^L, \dim_{min} G^L$  in case.

**Theorem 2.7**([8]) *Let  $G^L$  be a graph labeled by  $\mathbf{R}^{n_{v_1}}, \mathbf{R}^{n_{v_2}}, \dots, \mathbf{R}^{n_{|G|}}$  on vertices. Then its maximum dimension  $\dim_{max} G^L$  is*

$$\dim_{max} G^L = 1 - m + \sum_{v \in V(G^L)} n_v$$

with conditions  $\dim(\mathbf{R}^{n_u} \cap \mathbf{R}^{n_v}) = 1$  for  $\forall uv \in E(G^L)$ .

However, for determining the minimum value  $\dim_{min} G^L$  of graph  $G^L$  labeled by Euclidean spaces is a difficult problem in general. We only know the following result on labeled complete graphs  $K_m, m \geq 3$ .

**Theorem 2.8**([8]) *For any integer  $r \geq 2$ , let  $K_m^L(r)$  be a complete graph  $K_m$  labeled by Euclidean space  $\mathbf{R}^r$  on its vertices, and there exists an integer  $s, 0 \leq s \leq r - 1$  such that*

$$\binom{r+s-1}{r} < m \leq \binom{r+s}{r}.$$

Then

$$\dim_{min} K_m^L(r) = r + s.$$

Particularly,

$$\dim_{\min} K_m^L(3) = \begin{cases} 3, & \text{if } m = 1, \\ 4, & \text{if } 2 \leq m \leq 4, \\ 5, & \text{if } 5 \leq m \leq 10, \\ 2 + \lceil \sqrt{m} \rceil, & \text{if } m \geq 11. \end{cases}$$

All of these results presents a combinatorial model for characterizing things in the space  $\mathbb{R}^n, n \geq 4$ , particularly, the  $G^L$  solution of equations in the next subsection.

### 2.4 $G^L$ -Solution of Equations

Let  $\mathbb{R}^m, \mathbb{R}^n$  be Euclidean spaces of dimensional  $m, n \geq 1$  and let  $T : \mathbb{R}^n \times \mathbb{R}^m \rightarrow \mathbb{R}^m$  be a  $\mathbb{C}^k, 1 \leq k \leq \infty$  mapping such that  $T(\bar{x}_0, \bar{y}_0) = \bar{0}$  for  $\bar{x}_0 \in \mathbb{R}^n, \bar{y}_0 \in \mathbb{R}^m$  and the  $m \times m$  matrix  $\partial T^j / \partial y^i(\bar{x}_0, \bar{y}_0)$  is non-singular, i.e.,

$$\det\left(\frac{\partial T^j}{\partial y^i}\right) \Big|_{(\bar{x}_0, \bar{y}_0)} \neq 0, \text{ where } 1 \leq i, j \leq m.$$

Then the implicit mapping theorem concludes that there exist opened neighborhoods  $V \subset \mathbb{R}^n$  of  $\bar{x}_0, W \subset \mathbb{R}^m$  of  $\bar{y}_0$  and a  $\mathbb{C}^k$  mapping  $\phi : V \rightarrow W$  such that  $T(\bar{x}, \phi(\bar{x})) = \bar{0}$ . Thus there always exists solution  $\bar{y}$  for the equation  $T(\bar{x}, \bar{y}) = \bar{0}$  in case.

By the implicit function theorem, we can always choose mappings  $T_1, T_2, \dots, T_m$  and subsets  $S_{T_i} \subset \mathbb{R}^n$  where  $S_{T_i} \neq \emptyset$  such that  $T_i : S_{T_i} \rightarrow 0$  for integers  $1 \leq i \leq m$ . Consider the system of equations

$$\begin{cases} T_1(x_1, x_2, \dots, x_n) = 0 \\ T_2(x_1, x_2, \dots, x_n) = 0 \\ \dots\dots\dots \\ T_m(x_1, x_2, \dots, x_n) = 0 \end{cases} \quad (ES_m)$$

in Euclidean space  $\mathbb{R}^n, n \geq 1$ . Clearly, the system  $(ES_m)$  is non-solvable or not dependent on

$$\bigcap_{i=1}^m S_{T_i} = \emptyset \text{ or } \neq \emptyset.$$

This fact implies the following interesting result.

**Theorem 2.9** *A system  $(ES_m)$  of equations is solvable if and only if  $\bigcap_{i=1}^m S_{T_i} \neq \emptyset$ .*

Furthermore, if  $(ES_m)$  is solvable, it is obvious that  $G^L[ES_m] \simeq K_m^L$ . We conclude that  $(ES_m)$  is non-solvable if  $G^L[ES_m] \not\simeq K_m^L$ . Thus the case of solvable is special respect to the general case, non-solvable. However, the understanding on non-solvable case was abandoned in classical for a wrongly thinking, i.e., meaningless for hold on the reality of things.

By Definition 2.2, all spaces  $S_{T_i}, 1 \leq i \leq m$  exist for the system  $(ES_m)$  and we are easily get a labeled graph  $G^L[ES_m]$ , which is in fact a combinatorial space, a really geometrical figure

in  $\mathbb{R}^n$ . For example, in cases of linear algebraic equations, we can further determine  $G^L[ES_m]$  whatever the system  $(ES_m)$  is solvable or not as follows.

A *parallel family*  $\mathcal{C}$  of system  $(ES_m)$  of linear equations consists of linear equations in  $(ES_m)$  such that they are parallel two by two but there are no other linear equations parallel to any one in  $\mathcal{C}$ . We know a conclusion following on  $G^L[ES_m]$  for linear algebraic systems.

**Theorem 2.10**([12]) *Let  $(ES_m)$  be a linear equation system for integers  $m, n \geq 1$ . Then*

$$G^L[ES_m] \simeq K_{n_1, n_2, \dots, n_s}^L$$

with  $n_1 + n_2 + \dots + n_s = m$ , where  $\mathcal{C}_i$  is the parallel family with  $n_i = |\mathcal{C}_i|$  for integers  $1 \leq i \leq s$  in  $(ES_m)$  and it is non-solvable if  $s \geq 2$ .

Similarly, let

$$\dot{X} = A_1X, \dots, \dot{X} = A_kX, \dots, \dot{X} = A_mX \tag{LDES_m^1}$$

be a linear ordinary differential equation system of first order with

$$A_k = \begin{bmatrix} a_{11}^{[k]} & a_{12}^{[k]} & \dots & a_{1n}^{[k]} \\ a_{21}^{[k]} & a_{22}^{[k]} & \dots & a_{2n}^{[k]} \\ \dots & \dots & \dots & \dots \\ a_{n1}^{[k]} & a_{n2}^{[k]} & \dots & a_{nn}^{[k]} \end{bmatrix} \quad \text{and} \quad X = \begin{bmatrix} x_1(t) \\ x_2(t) \\ \dots \\ x_n(t) \end{bmatrix}$$

where each  $a_{ij}^{[k]}$  is a real number for integers  $0 \leq k \leq m, 1 \leq i, j \leq n$ .

Notice that the solution space of the  $i$ th in  $(LDES_m^1)$  is a linear space. We know the result following.

**Theorem 2.11**([13], [14]) *Every linear system  $(LDES_m^1)$  of homogeneous differential equations uniquely determines a labeled graph  $G^L[LDES_m^1]$ , and conversely, every graph  $G^L$  labeled by basis of linear spaces uniquely determines a homogeneous differential equation system  $(LDES_m^1)$  such that  $G^L[LDES_m^1] \simeq G^L$ .*

For example, let  $(LDES_m^1)$  be the system of linear homogeneous differential equations

$$\begin{cases} \ddot{x} - 3\dot{x} + 2x = 0 & (1) \\ \ddot{x} - 5\dot{x} + 6x = 0 & (2) \\ \ddot{x} - 7\dot{x} + 12x = 0 & (3) \\ \ddot{x} - 9\dot{x} + 20x = 0 & (4) \\ \ddot{x} - 11\dot{x} + 30x = 0 & (5) \\ \ddot{x} - 7\dot{x} + 6x = 0 & (6) \end{cases}$$

where  $\ddot{x} = \frac{d^2x}{dt^2}$  and  $\dot{x} = \frac{dx}{dt}$ . Then the solution basis of equations (1) – (6) are respectively  $\{e^t, e^{2t}\}, \{e^{2t}, e^{3t}\}, \{e^{3t}, e^{4t}\}, \{e^{4t}, e^{5t}\}, \{e^{5t}, e^{6t}\}, \{e^{6t}, e^t\}$  with a labeled graph shown in Fig.8.



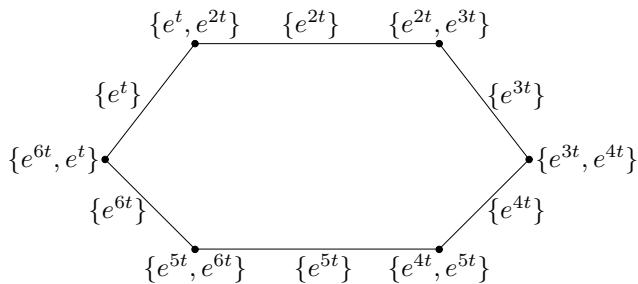

Fig.8

An integral labeled graph  $G^{L^I}$  is such a labeling  $L^I : G \rightarrow \mathbb{Z}^+$  that  $L^I(uv) \leq \min\{L^I(u), L^I(v)\}$  for  $\forall uv \in E(G)$ , and two integral labeled graphs  $G_1^{L^I}$  and  $G_2^{L^I}$  are said to be identical, denoted by  $G_1^{L^I} = G_2^{L^I}$  if  $G_1 \cong G_2$  and  $L_1^I(x) = L_2^I(\varphi(x))$  for graph isomorphisms  $\varphi$  and  $\forall x \in V(G_1) \cup E(G_1)$ . For example, these labeled graphs shown in Fig.9 are all integral on  $K_4 - e$ , we know  $G_1^{L^I} = G_2^{L^I}$  but  $G_1^{L^I} \neq G_3^{L^I}$  by definition.

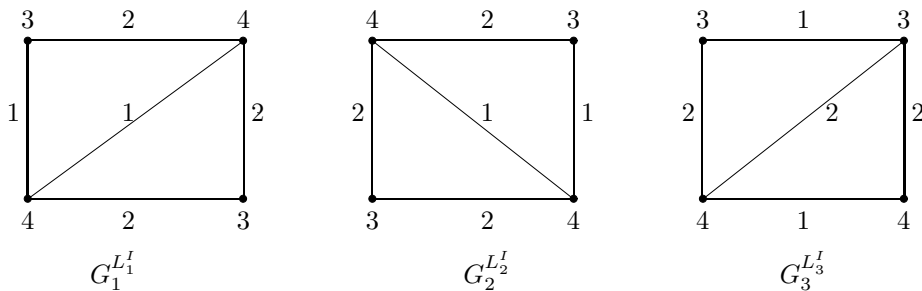

Fig.9

For 2 linear systems  $(LDES_m^1)$ ,  $(LDES_m^1)'$  of ordinary differential equations, they are called *combinatorially equivalent*, denoted by  $(LDES_m^1) \cong (LDES_m^1)'$  if there is an isomorphism  $\varphi : G^L[LDES_m^1] \rightarrow G^{L'}[LDES_m^1]'$  of graph, linear isomorphisms  $\xi : x \rightarrow \xi(x)$  of spaces and labelings  $L_1, L_2$  such that  $\varphi L_1(x) = L_2 \varphi(\xi(x))$  for  $\forall x \in V(G^L[LDES_m^1]) \cup E(G^L[LDES_m^1])$ , which are completely characterized by the integral labeled graphs.

**Theorem 2.12**([13], [14]) *Let  $(LDES_m^1)$ ,  $(LDES_m^1)'$  be two linear system of ordinary differential equations with integral labeled graphs  $G^{L^I}[LDES_m^1]$ ,  $G^{L^I'}[LDES_m^1]'$ . Then  $(LDES_m^1) \cong (LDES_m^1)'$  if and only if  $G^{L^I}[LDES_m^1] = G^{L^I'}[LDES_m^1]'$ .*

### §3. Graphical Tensors

As shown in last section, labeled graphs by sets, particularly, geometrical sets such as those of Euclidean spaces  $\mathbb{R}^n, n \geq 1$  are useful for holding on things characterized by non-solvable systems of equations. A further question on labeled graphs is

For labeled graphs  $G_1^L, G_2^L, G_3^L$ , is there a binary operation  $o : (G_1^L, G_2^L) \rightarrow G_3^L$ ? And can we established algebra on labeled graphs?

Answer these questions enables one to extend linear spaces over graphs  $G$  hold with conservation laws on its each vertex and establish tensors underlying graphs.

### 3.1 Action Flows

Let  $(\mathcal{V}; +, \cdot)$  be a linear space over a field  $\mathcal{F}$ . An *action flow*  $(\vec{G}; L, A)$  is an oriented embedded graph  $\vec{G}$  in a topological space  $\mathcal{S}$  associated with a mapping  $L : (v, u) \rightarrow L(v, u)$ , 2 end-operators  $A_{vu}^+ : L(v, u) \rightarrow L^{A_{vu}^+}(v, u)$  and  $A_{uv}^+ : L(u, v) \rightarrow L^{A_{uv}^+}(u, v)$  on  $\mathcal{V}$  with  $L(v, u) = -L(u, v)$  and  $A_{vu}^+(-L(v, u)) = -L^{A_{vu}^+}(v, u)$  for  $\forall (v, u) \in E(\vec{G})$

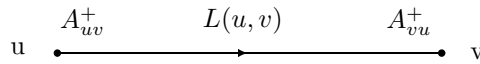

Fig.10

holding with conservation laws

$$\sum_{u \in N_G(v)} L^{A_{vu}^+}(v, u) = \mathbf{0} \text{ for } \forall v \in V(\vec{G})$$

such as those shown for vertex  $v$  in Fig.11 following

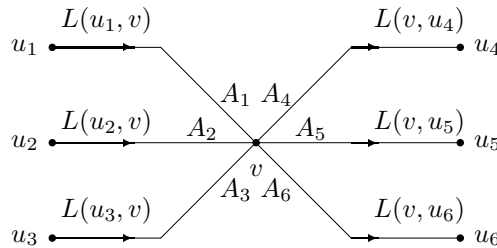

Fig.11

with a conservation law

$$-L^{A_1}(v, u_1) - L^{A_2}(v, u_2) - L^{A_3}(v, u_3) + L^{A_4}(v, u_4) + L^{A_5}(v, u_5) + L^{A_6}(v, u_6) = \mathbf{0},$$

and such a set  $\{-L^{A_i}(v, u_i), 1 \leq i \leq 3\} \cup \{L^{A_j}, 4 \leq j \leq 6\}$  is called a conservation family at vertex  $v$ .

Action flow is a useful model for holding on natural things. It combines the discrete with that of analytical mathematics and therefore, it can help human beings understanding the nature.

For example, let  $L : (v, u) \rightarrow L(v, u) \in \mathbb{R}^n \times \mathbb{R}^+$  with action operators  $A_{vu}^+ = a_{vu} \frac{\partial}{\partial t}$  and  $a_{vu} : \mathbb{R}^n \rightarrow \mathbb{R}$  for any edge  $(v, u) \in E(\vec{G})$  in Fig.12.

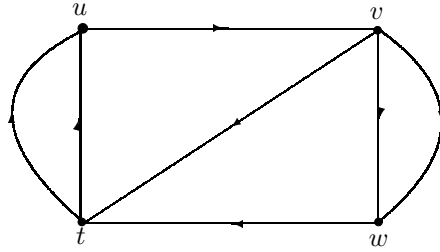

Fig.12

Then the conservation laws are partial differential equations

$$\left\{ \begin{array}{l} a_{tu^1} \frac{\partial L(t, u)^1}{\partial t} + a_{tu^2} \frac{\partial L(t, u)^2}{\partial t} = a_{uv} \frac{\partial L(u, v)}{\partial t} \\ a_{uv} \frac{\partial L(u, v)}{\partial t} = a_{vw^1} \frac{\partial L(v, w)^1}{\partial t} + a_{vw^2} \frac{\partial L(v, w)^2}{\partial t} + a_{vt} \frac{\partial L(v, t)}{\partial t} \\ a_{vw^1} \frac{\partial L(v, w)^1}{\partial t} + a_{vw^2} \frac{\partial L(v, w)^2}{\partial t} = a_{wt} \frac{\partial L(w, t)}{\partial t} \\ a_{wt} \frac{\partial L(w, t)}{\partial t} + a_{vt} \frac{\partial L(v, t)}{\partial t} = a_{tu^1} \frac{\partial L(t, u)^1}{\partial t} + a_{tu^2} \frac{\partial L(t, u)^2}{\partial t} \end{array} \right. ,$$

which maybe solvable or not but characterizes behavior of natural things.

If  $A = \mathbf{1}_\mathcal{V}$ , an action flows  $(\vec{G}; L, \mathbf{1}_\mathcal{V})$  is called  $\vec{G}$ -flow and denoted by  $\vec{G}^L$  for simplicity. We naturally define

$$\vec{G}^{L_1} + \vec{G}^{L_2} = \vec{G}^{L_1+L_2} \quad \text{and} \quad \lambda \cdot \vec{G}^L = \vec{G}^{\lambda \cdot L}$$

for  $\forall \lambda \in \mathcal{F}$ . All  $\vec{G}$ -flows  $\vec{G}^\mathcal{V}$  on  $\vec{G}$  naturally form a linear space  $(\vec{G}^\mathcal{V}; +, \cdot)$  because it hold with:

- (1) A field  $\mathcal{F}$  of scalars;
- (2) A set  $\vec{G}^\mathcal{V}$  of objects, called extended vectors;
- (3) An operation “+”, called extended vector addition, which associates with each pair of vectors  $\vec{G}^{L_1}, \vec{G}^{L_2}$  in  $\vec{G}^\mathcal{V}$  a extended vector  $\vec{G}^{L_1+L_2}$  in  $\vec{G}^\mathcal{V}$ , called the sum of  $\vec{G}^{L_1}$  and  $\vec{G}^{L_2}$ , in such a way that

- (a) Addition is commutative,  $\vec{G}^{L_1} + \vec{G}^{L_2} = \vec{G}^{L_2} + \vec{G}^{L_1}$ ;
- (b) Addition is associative,  $(\vec{G}^{L_1} + \vec{G}^{L_2}) + \vec{G}^{L_3} = \vec{G}^{L_1} + (\vec{G}^{L_2} + \vec{G}^{L_3})$ ;

(c) There is a unique extended vector  $\vec{G}^{\mathbf{0}}$ , i.e.,  $\mathbf{0}(v, u) = \mathbf{0}$  for  $\forall (v, u) \in E(\vec{G})$  in  $\vec{G}^\mathcal{V}$ , called zero vector such that  $\vec{G}^L + \vec{G}^{\mathbf{0}} = \vec{G}^L$  for all  $\vec{G}^L$  in  $\vec{G}^\mathcal{V}$ ;

(d) For each extended vector  $\vec{G}^L$  there is a unique extended vector  $\vec{G}^{-L}$  such that  $\vec{G}^L + \vec{G}^{-L} = \vec{G}^{\mathbf{0}}$  in  $\vec{G}^\mathcal{V}$ ;

(4) An operation “ $\cdot$ ”, called scalar multiplication, which associates with each scalar  $k$  in  $F$  and an extended vector  $\vec{G}^L$  in  $\vec{G}^\mathcal{V}$  an extended vector  $k \cdot \vec{G}^L$  in  $\mathcal{V}$ , called the product of  $k$  with  $\vec{G}^L$ , in such a way that

- (a)  $1 \cdot \vec{G}^L = \vec{G}^L$  for every  $\vec{G}^L$  in  $\vec{G}^\mathcal{V}$ ;
- (b)  $(k_1 k_2) \cdot \vec{G}^L = k_1(k_2 \cdot \vec{G}^L)$ ;

- (c)  $k \cdot (\vec{G}^{L_1} + \vec{G}^{L_2}) = k \cdot \vec{G}^{L_1} + k \cdot \vec{G}^{L_2};$
- (d)  $(k_1 + k_2) \cdot \vec{G}^L = k_1 \cdot \vec{G}^L + k_2 \cdot \vec{G}^L.$

### 3.2 Dimension of Action Flow Space

**Theorem 3.1** *Let  $\mathcal{G}$  be all action flows  $(\vec{G}; L, A)$  with  $A \in \mathbf{O}(\mathcal{V})$ . Then*

$$\dim \mathcal{G} = (\dim \mathbf{O}(\mathcal{V}) \times \dim \mathcal{V})^{\beta(\vec{G})}$$

*if both  $\mathcal{V}$  and  $\mathbf{O}(\mathcal{V})$  are finite. Otherwise,  $\dim \mathcal{G}$  is infinite.*

*Particularly, if operators  $A \in \mathcal{V}^*$ , the dual space of  $\mathcal{V}$  on graph  $\vec{G}$ , then*

$$\dim \mathcal{G} = (\dim \mathcal{V})^{2\beta(\vec{G})},$$

*where  $\beta(\vec{G}) = \varepsilon(\vec{G}) - |\vec{G}| + 1$  is the Betti number of  $\vec{G}$ .*

*Proof* The infinite case is obvious. Without loss of generality, we assume  $\vec{G}$  is connected with dimensions of  $\mathcal{V}$  and  $\mathbf{O}(\mathcal{V})$  both finite. Let  $L(v) = \{L^{A_{vu}^+}(v, u) \in \mathcal{V} \text{ for some } u \in V(\vec{G})\}$ ,  $v \in V(\vec{G})$  be the conservation families in  $\mathcal{V}$  associated with  $(\vec{G}; L, A)$  such that  $L^{A_{vu}^+}(v, u) = -A_{uv}^+(L(u, v))$  and  $L(v) \cap (-L(u)) = L^{A_{vu}^+}(v, u)$  or  $\emptyset$ . An edge  $(v, u) \in E(\vec{G})$  is *flow freely* or not in  $\vec{G}^{\mathcal{V}}$  if  $L^{A_{vu}^+}(v, u)$  can be any vector in  $\mathcal{V}$  or not. Notice that  $L(v) = \{L^{A_{vu}^+}(v, u) \in \mathcal{V} \text{ for some } u \in V(\vec{G})\}$ ,  $v \in V(\vec{G})$  are the conservation families associated with action flow  $(\vec{G}; L, A)$ . There is one flow non-freely edges for any vertex in  $\vec{G}$  at least and  $\dim \mathcal{G}$  is nothing else but the number of independent vectors  $L(v, u)$  and independent end-operators  $A_{vu}^+$  on edges in  $\vec{G}$  which can be chosen freely in  $\mathcal{V}$ .

We claim that all flow non-freely edges form a connected subgraph  $T$  in  $\vec{G}$ . If not, there are two components  $C_1(T)$  and  $C_2(T)$  in  $T$  such as those shown in Fig.13.

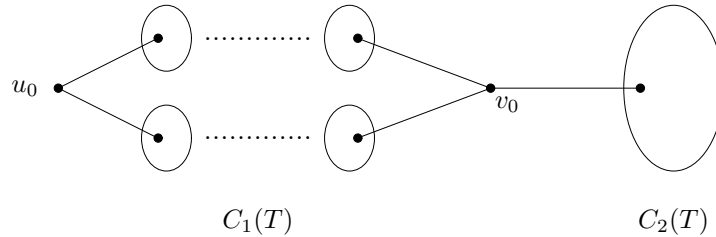

**Fig.13**

In this case, all edges between  $C_1(T)$  and  $C_2(T)$  are flow freely in  $\vec{G}$ . Let  $v_0$  be such a vertex in  $C_1(T)$  adjacent to a vertex in  $C_2(T)$ . Beginning from the vertex  $v_0$  in  $C_1(T)$ , we

choose vectors on edges in

$$\begin{aligned}
 & E_G(v_0, N_G(v_0)) \cap \langle C_1(T) \rangle_G, \\
 & E_G(N_G(v_0) \setminus \{v_0\}, N_G(N_G(v_0)) \setminus N_G(v_0)) \cap \langle C_1(T) \rangle_G, \\
 & \dots\dots\dots
 \end{aligned}$$

in  $\langle C_1(T) \rangle_G$  by conservation laws, and then finally arrive at a vertex  $u_0 \in V(C_2(T))$  such that all flows from  $V(C_1(T)) \setminus \{u_0\}$  to  $u_0$  are fixed by conservation laws of vertices  $N_G(u_0)$ , which result in that there are no conservation law of flows on the vertex  $u_0$ , a contradiction. Hence, all flow freely edges form a connected subgraph in  $\vec{G}$ . Hence, we get that

$$\begin{aligned}
 \dim \mathcal{G} & \leq \dim \mathbf{O}(\mathcal{V})^{|E(\vec{G})-E(T)|} \times (\dim \mathcal{V})^{|E(\vec{G})-E(T)|} \\
 & = (\dim \mathbf{O}(\mathcal{V}) \times \dim \mathcal{V})^{\beta(\vec{G})}.
 \end{aligned}$$

We can indeed determine a flow non-freely tree  $T$  in  $\vec{G}$  by programming following:

STEP 1. Define  $X_1 = \{v_1\}$  for  $\forall v_1 \in V(\vec{G})$ ;

STEP 2. If  $V(\vec{G}) \setminus X_1 \neq \emptyset$ , choose  $v_2 \in N_G(v_1) \setminus X_1$  and let  $(v_1, v_2)$  be a flow non-freely edge by conservation law on  $v_1$  and define  $X_2 = \{v_1, v_2\}$ . Otherwise,  $T = v_0$ .

STEP 3. If  $V(\vec{G}) \setminus X_2 \neq \emptyset$ , choose  $v_3 \in N_G(X_1) \setminus X_2$ . Without loss of generality, assume  $v_3$  adjacent with  $v_2$  and let  $(v_2, v_3)$  be a flow non-freely edge by conservation law on  $v_2$  with  $X_3 = \{v_1, v_2, v_3\}$ . Otherwise,  $T = v_1 v_2$ .

STEP 4. For any integer  $k \geq 2$ , if  $X_k$  has been defined and  $V(\vec{G}) \setminus X_k \neq \emptyset$ , choose  $v_{k+1} \in N_G(X_k) \setminus X_k$ . Assume  $v_{k+1}$  adjacent with  $v^k \in X_k$  and let  $(v^k, v_{k+1})$  be a flow non-freely edge by conservation law on  $v^k$  with  $X_{k+1} = X_k \cup \{v_{k+1}\}$ . Otherwise,  $T$  is the flow non-freely tree spanned by  $\langle X_k \rangle$  in  $\vec{G}$ .

STEP 5. The procedure is ended if  $X_{|\vec{G}|}$  has been defined which enable one get a spanning flow non-freely tree  $T$  of  $\vec{G}$ .

Clearly, all edges in  $E(\vec{G}) \setminus E(T)$  are flow freely in  $\mathcal{V}$ . We therefore know

$$\begin{aligned}
 \dim \mathcal{G} & \geq (\dim \mathbf{O}(\mathcal{V}))^{\varepsilon(\vec{G})-\varepsilon(T)} \times (\dim \mathcal{V})^{\varepsilon(\vec{G})-\varepsilon(T)} \\
 & = (\dim \mathbf{O}(\mathcal{V}) \times \dim \mathcal{V})^{\varepsilon(\vec{G})-|\vec{G}|+1} = (\dim \mathbf{O}(\mathcal{V}) \times \dim \mathcal{V})^{2\beta(\vec{G})}.
 \end{aligned}$$

Thus,

$$\dim \mathcal{G} = (\dim \mathbf{O}(\mathcal{V}) \times \dim \mathcal{V})^{2\beta(\vec{G})}. \tag{3.1}$$

If operators  $A \in \mathcal{V}^*$ ,  $\dim \mathcal{V}^* = \dim \mathcal{V}$ . We are easily get

$$\dim \mathcal{G} = (\dim \mathcal{V})^{2\beta(\vec{G})}$$

by the equation (3.1). This completes the proof. □

Particularly, for action flows  $(\vec{G}; L, \mathbf{1}_{\mathcal{V}})$ , i.e.,  $\vec{G}$ -flow space we have a conclusion on its dimension following

**Corollary 3.2**  $\dim \vec{G}^{\mathcal{V}} = (\dim \mathcal{V})^{\beta(\vec{G})}$  if  $\mathcal{V}$  is finite. Otherwise,  $\dim \mathcal{H}$  is infinite.

### 3.3 Graphical Tensors

**Definition 3.3** Let  $(\vec{G}_1; L_1, A_1)$  and  $(\vec{G}_2; L_2, A_2)$  be action flows on linear space  $\mathcal{V}$ . Their tensor product  $(\vec{G}_1; L_1, A_1) \otimes (\vec{G}_2; L_2, A_2)$  is defined on graph  $\vec{G}_1 \otimes \vec{G}_2$  with mapping

$$L : ((v_1, u_1), (v_2, u_2)) \rightarrow (L_1(v_1, u_1), L_2(v_2, u_2))$$

on edge  $((v_1, u_1), (v_2, u_2)) \in E(\vec{G}_1 \otimes \vec{G}_2)$  and end-operators  $A_{(v_1, u_1)(v_2, u_2)}^+ = A_{v_1 u_1}^+ \otimes A_{v_2 u_2}^+$ ,  $A_{(v_2, u_2)(v_1, u_1)}^+ = A_{u_1 v_1}^+ \otimes A_{u_2 v_2}^+$ , such as those shown in Fig.14.

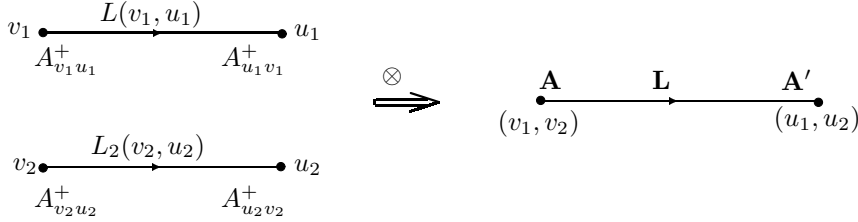

**Fig.14**

with  $\mathbf{L} = (L_1(v_1, u_1), L_2(v_2, u_2))$  and  $\mathbf{A} = A_{v_1 u_1}^+ \otimes A_{v_2 u_2}^+$ ,  $\mathbf{A}' = A_{u_1 v_1}^+ \otimes A_{u_2 v_2}^+$ , where  $\vec{G}_1 \otimes \vec{G}_2$  is the tensor product of  $\vec{G}_1$  and  $\vec{G}_2$  with

$$V(\vec{G}_1 \otimes \vec{G}_2) = V(\vec{G}_1) \times V(\vec{G}_2)$$

and

$$E(\vec{G}_1 \otimes \vec{G}_2) = \{((v_1, v_2), (u_1, u_2)) \mid \text{if and only if} \\ (v_1, u_1) \in E(\vec{G}_1) \text{ and } (v_2, u_2) \in E(\vec{G}_2)\}$$

with an orientation  $O^+ : (v_1, v_2) \rightarrow (u_1, u_2)$  on  $((v_1, v_2), (u_1, u_2)) \in E(\vec{G}_1 \otimes \vec{G}_2)$ .

Indeed,  $(\vec{G}_1; L_1, A_1) \otimes (\vec{G}_2; L_2, A_2)$  is an action flow with conservation laws on each vertex in  $\vec{G}_1 \otimes \vec{G}_2$  because

$$\begin{aligned} & \sum_{(u_1, u_2) \in N_{\vec{G}_1 \otimes \vec{G}_2}(v_1, v_2)} A_{v_1 u_1}^+ \otimes A_{v_2 u_2}^+ (L_1(v_1, u_1), L_2(v_2, u_2)) \\ &= \sum_{(u_1, u_2) \in N_{\vec{G}_1 \otimes \vec{G}_2}(v_1, v_2)} A_{v_1 u_1}^+ (L_1(v_1, u_1)) A_{v_2 u_2}^+ (L_2(v_2, u_2)) \\ &= \left( \sum_{u_1 \in N_{\vec{G}_1}(v_1)} (L_1(v_1, u_1))^{A_{v_1 u_1}^+} \right) \times \left( \sum_{u_2 \in N_{\vec{G}_2}(v_2)} (L_2(v_2, u_2))^{A_{v_2 u_2}^+} \right) = \mathbf{0} \end{aligned}$$

for  $\forall (v_1, v_2) \in V(\vec{G}_1 \otimes \vec{G}_2)$  by definition.

**Theorem 3.4** *The tensor operation is associative, i.e.,*

$$\begin{aligned} & \left( (\vec{G}_1; L_1, A_1) \otimes (\vec{G}_2; L_2, A_2) \right) \otimes (\vec{G}_3; L_3, A_3) \\ &= (\vec{G}_1; L_1, A_1) \otimes \left( (\vec{G}_2; L_2, A_2) \otimes (\vec{G}_3; L_3, A_3) \right). \end{aligned}$$

*Proof* By definition,  $(\vec{G}_1 \otimes \vec{G}_2) \otimes \vec{G}_3 = \vec{G}_1 \otimes (\vec{G}_2 \otimes \vec{G}_3)$ . Let  $(v_1, u_1) \in E(\vec{G}_1)$ ,  $(v_2, u_2) \in E(\vec{G}_2)$  and  $(v_3, u_3) \in E(\vec{G}_3)$ . Then,  $((v_1, v_2, v_3), (u_1, u_2, u_3)) \in E(\vec{G}_1 \otimes \vec{G}_2 \otimes \vec{G}_3)$  with flows  $(L_1(v_1, u_1), L_2(v_2, u_2), L_3(v_3, u_3))$ , and end-operators  $(A_{v_1 u_1}^+ \otimes A_{v_2, u_2}^+ \otimes A_{v_3 u_3}^+)$  in  $\left( (\vec{G}_1; L_1, A_1) \otimes (\vec{G}_2; L_2, A_2) \right) \otimes (\vec{G}_3; L_3, A_3)$  but  $A_{v_1 u_1}^+ \otimes (A_{v_2, u_2}^+ \otimes A_{v_3 u_3}^+)$  in  $(\vec{G}_1; L_1, A_1) \otimes \left( (\vec{G}_2; L_2, A_2) \otimes (\vec{G}_3; L_3, A_3) \right)$  on the vertex  $(v_1, v_2, v_3)$ . However,

$$(A_{v_1 u_1}^+ \otimes A_{v_2, u_2}^+) \otimes A_{v_3 u_3}^+ = A_{v_1 u_1}^+ \otimes (A_{v_2, u_2}^+ \otimes A_{v_3 u_3}^+)$$

for tensors. This completes the proof. □

Theorem 3.4 enables one to define the product  $\bigotimes_{i=1}^n (\vec{G}_i; L_i, A_i)$ . Clearly, if  $\{\vec{G}_i^{L_{i1}}, \vec{G}_i^{L_{i2}}, \dots, \vec{G}_i^{L_{in_i}}\}$  is a base of  $\vec{G}_i^{\mathcal{Y}}$ , then  $\vec{G}_1^{L_{1i_1}} \otimes \vec{G}_2^{L_{2i_2}} \otimes \dots \otimes \vec{G}_n^{L_{ni_n}}$ ,  $1 \leq i_j \leq n_i, 1 \leq i \leq n$  form a base of  $\vec{G}_1^{\mathcal{Y}_1} \otimes \vec{G}_2^{\mathcal{Y}_2} \otimes \dots \otimes \vec{G}_n^{\mathcal{Y}_n}$ . This implies a result by Theorem 3.1 and Corollary 3.2.

**Theorem 3.5** 
$$\dim \left( \bigotimes_{i=1}^m (\vec{G}_i; L_i, A_i) \right) = \prod_{i=1}^m \dim \mathcal{Y}_i^{2\beta(\vec{G}_i)}.$$

Particularly,  $\dim \left( \bigotimes_{i=1}^m \vec{G}_i^{\mathcal{Y}_i} \right) = \prod_{i=1}^m \dim \mathcal{Y}_i^{\beta(\vec{G}_i)}$  and furthermore, if  $\mathcal{Y}_i = \mathcal{Y}$  for integers  $1 \leq i \leq m$ , then

$$\dim \left( \bigotimes_{i=1}^m \vec{G}_i^{\mathcal{Y}} \right) = \dim \mathcal{Y}^{\sum_{i=1}^m \beta(\vec{G}_i)},$$

and if each  $\vec{G}_i$  is a circuit  $\vec{C}_{n_i}$ , or each  $\vec{G}_i$  is a bouquet  $\vec{B}_{n_i}$  for integers  $1 \leq i \leq m$ , then

$$\dim \left( \bigotimes_{i=1}^n \vec{G}_i^{\mathcal{Y}} \right) = \dim \mathcal{Y}^n \quad \text{or} \quad \dim \left( \bigotimes_{i=1}^n \vec{G}_i^{\mathcal{Y}} \right) = \dim \mathcal{Y}^{n_1+n_2+\dots+n_m}.$$

#### §4. Banach $\vec{G}$ -Flow Spaces

The Banach and Hilbert spaces are linear space  $\mathcal{Y}$  over a field  $\mathbb{R}$  or  $\mathbb{C}$  respectively equipped with a complete norm  $\|\cdot\|$  or inner product  $\langle \cdot, \cdot \rangle$ , i.e., for every Cauchy sequence  $\{x_n\}$  in  $\mathcal{Y}$ , there exists an element  $x$  in  $\mathcal{Y}$  such that

$$\lim_{n \rightarrow \infty} \|x_n - x\|_{\mathcal{Y}} = 0 \quad \text{or} \quad \lim_{n \rightarrow \infty} \langle x_n - x, x_n - x \rangle_{\mathcal{Y}} = 0.$$

We extend Banach or Hilbert spaces over graph  $\vec{G}$  by a kind of edge labeled graphs, i.e.,  $\vec{G}$ -flows in this section.

#### 4.1 Banach $\vec{G}$ -Flow Spaces

Let  $\mathcal{V}$  be a Banach space over a field  $\mathcal{F}$  with  $\mathcal{F} = \mathbb{R}$  or  $\mathbb{C}$ . For any  $\vec{G}$ -flow  $\vec{G}^L \in \vec{G}^{\mathcal{V}}$ , define

$$\|\vec{G}^L\| = \sum_{(v,u) \in E(\vec{G})} \|L(v,u)\|,$$

where  $\|L(v,u)\|$  is the norm of  $L(v,u)$  in  $\mathcal{V}$ . Then it is easily to check that

- (1)  $\|\vec{G}^L\| \geq 0$  and  $\|\vec{G}^L\| = 0$  if and only if  $\vec{G}^L = \vec{G}^{\mathbf{0}}$ .
- (2)  $\|\vec{G}^{\xi L}\| = \xi \|\vec{G}^L\|$  for any scalar  $\xi$ .
- (3)  $\|\vec{G}^{L_1} + \vec{G}^{L_2}\| \leq \|\vec{G}^{L_1}\| + \|\vec{G}^{L_2}\|$ .

Whence,  $\|\cdot\|$  is a norm on linear space  $\vec{G}^{\mathcal{V}}$ . Furthermore, if  $\mathcal{V}$  is an inner space, define

$$\langle \vec{G}^{L_1}, \vec{G}^{L_2} \rangle = \sum_{(v,u) \in E(\vec{G})} \langle L_1(v,u), L_2(v,u) \rangle.$$

Then

- (4)  $\langle \vec{G}^L, \vec{G}^L \rangle \geq 0$  and  $\langle \vec{G}^L, \vec{G}^L \rangle = 0$  if and only if  $L(v,u) = \mathbf{0}$  for  $\forall (v,u) \in E(\vec{G})$ , i.e.,  $\vec{G}^L = \vec{G}^{\mathbf{0}}$ .
- (5)  $\langle \vec{G}^{L_1}, \vec{G}^{L_2} \rangle = \overline{\langle \vec{G}^{L_2}, \vec{G}^{L_1} \rangle}$  for  $\forall \vec{G}^{L_1}, \vec{G}^{L_2} \in \vec{G}^{\mathcal{V}}$ .
- (6) For  $\vec{G}^L, \vec{G}^{L_1}, \vec{G}^{L_2} \in \vec{G}^{\mathcal{V}}$ , there is

$$\begin{aligned} & \langle \lambda \vec{G}^{L_1} + \mu \vec{G}^{L_2}, \vec{G}^L \rangle \\ &= \lambda \langle \vec{G}^{L_1}, \vec{G}^L \rangle + \mu \langle \vec{G}^{L_2}, \vec{G}^L \rangle. \end{aligned}$$

Thus,  $\vec{G}^{\mathcal{V}}$  is an inner space. As the usual, let

$$\|\vec{G}^L\| = \sqrt{\langle \vec{G}^L, \vec{G}^L \rangle}$$

for  $\vec{G}^L \in \vec{G}^{\mathcal{V}}$ . Then it is also a normed space.

If the norm  $\|\cdot\|$  and inner product  $\langle \cdot, \cdot \rangle$  are complete, then  $\|\vec{G}^L\|$  and  $\langle \vec{G}^L, \vec{G}^L \rangle$  are too also, i.e., any Cauchy sequence in  $\vec{G}^{\mathcal{V}}$  is converges. In fact, let  $\{\vec{G}^{L_n}\}$  be a Cauchy sequence in  $\vec{G}^{\mathcal{V}}$ . Then for any number  $\varepsilon > 0$ , there exists an integer  $N(\varepsilon)$  such that

$$\|\vec{G}^{L_n} - \vec{G}^{L_m}\| < \varepsilon$$



if  $n, m \geq N(\varepsilon)$ . By definition,

$$\|L_n(v, u) - L_m(v, u)\| \leq \|\vec{G}^{L_n} - \vec{G}^{L_m}\| < \varepsilon$$

i.e.,  $\{L_n(v, u)\}$  is also a Cauchy sequence for  $\forall(v, u) \in E(\vec{G})$ , which is converges in  $\mathcal{V}$  by definition.

Now let  $L(v, u) = \lim_{n \rightarrow \infty} L_n(v, u)$  for  $\forall(v, u) \in E(\vec{G})$ . Clearly,

$$\lim_{n \rightarrow \infty} \vec{G}^{L_n} = \vec{G}^L.$$

Even so, we are needed to show that  $\vec{G}^L \in \vec{G}^\mathcal{V}$ . By definition,

$$\sum_{u \in N_G(v)} L_n(v, u) = \mathbf{0}, \quad v \in V(\vec{G})$$

for any integer  $n \geq 1$ . If  $n \rightarrow \infty$  on both sides, we are easily knowing that

$$\begin{aligned} \lim_{n \rightarrow \infty} \left( \sum_{u \in N_G(v)} L_n(v, u) \right) &= \sum_{u \in N_G(v)} \lim_{n \rightarrow \infty} L_n(v, u) \\ &= \sum_{u \in N_G(v)} L(v, u) = \mathbf{0}. \end{aligned}$$

Thus,  $\vec{G}^L \in \vec{G}^\mathcal{V}$ , which implies that the norm is complete, which can be also applied to the case of Hilbert space. Thus we get the following result.

**Theorem 4.1**([18], [22]) *For any graph  $\vec{G}$ ,  $\vec{G}^\mathcal{V}$  is a Banach space, and furthermore, if  $\mathcal{V}$  is a Hilbert space,  $\vec{G}^\mathcal{V}$  is a Hilbert space also.*

An operator  $\mathbf{T} : \vec{G}^\mathcal{V} \rightarrow \vec{G}^\mathcal{V}$  is a *contractor* if

$$\|\mathbf{T}(\vec{G}^{L_1}) - \mathbf{T}(\vec{G}^{L_2})\| \leq \xi \|\vec{G}^{L_1} - \vec{G}^{L_2}\|$$

for  $\forall \vec{G}^{L_1}, \vec{G}^{L_2} \in \vec{G}^\mathcal{V}$  with  $\xi \in [0, 1)$ . The next result generalizes the fixed point theorem of Banach to Banach  $\vec{G}$ -flow space.

**Theorem 4.2**([18]) *Let  $\mathbf{T} : \vec{G}^\mathcal{V} \rightarrow \vec{G}^\mathcal{V}$  be a contractor. Then there is a uniquely  $G$ -flow  $\vec{G}^L \in \vec{G}^\mathcal{V}$  such that  $\mathbf{T}(\vec{G}^L) = \vec{G}^L$ .*

An operator  $\mathbf{T} : \vec{G}^\mathcal{V} \rightarrow \vec{G}^\mathcal{V}$  is *linear* if

$$\mathbf{T}(\lambda \vec{G}^{L_1} + \mu \vec{G}^{L_2}) = \lambda \mathbf{T}(\vec{G}^{L_1}) + \mu \mathbf{T}(\vec{G}^{L_2})$$

for  $\forall \vec{G}^{L_1}, \vec{G}^{L_2} \in \vec{G}^\mathcal{V}$  and  $\lambda, \mu \in \mathcal{F}$ . The following result generalizes the representation theorem of Fréchet and Riesz on linear continuous functionals to Hilbert  $\vec{G}$ -flow space  $\vec{G}^\mathcal{V}$ .

**Theorem 4.3**([18], [22]) *Let  $\mathbf{T} : \vec{G}^{\mathcal{Y}} \rightarrow \mathbb{C}$  be a linear continuous functional. Then there is a unique  $\vec{G}^{\hat{L}} \in \vec{G}^{\mathcal{Y}}$  such that  $\mathbf{T}(\vec{G}^L) = \langle \vec{G}^L, \vec{G}^{\hat{L}} \rangle$  for  $\forall \vec{G}^L \in \vec{G}^{\mathcal{Y}}$ .*

### 4.3 Examples of Linear Operator on Banach $\vec{G}$ -Flow Spaces

Let  $\mathcal{H}$  be a Hilbert space consisting of measurable functions  $f(x_1, x_2, \dots, x_n)$  on a set

$$\Delta = \{(x_1, x_2, \dots, x_n) \in \mathbb{R}^n | a_i \leq x_i \leq b_i, 1 \leq i \leq n\},$$

which is a functional space  $L^2[\Delta]$ , with inner product

$$\langle f(\mathbf{x}), g(\mathbf{x}) \rangle = \int_{\Delta} \overline{f(\mathbf{x})}g(\mathbf{x})d\mathbf{x} \text{ for } f(\mathbf{x}), g(\mathbf{x}) \in L^2[\Delta],$$

where  $\mathbf{x} = (x_1, x_2, \dots, x_n)$  and  $\vec{G}$  an oriented graph embedded in a topological space. As we shown in last section, we can extended  $\mathcal{H}$  on graph  $\vec{G}$  to get Hilbert  $\vec{G}$ -flow space  $\vec{G}^{\mathcal{H}}$ .

The *differential* and *integral operators*

$$D = \sum_{i=1}^n a_i \frac{\partial}{\partial x_i} \quad \text{and} \quad \int_{\Delta}$$

on  $\mathcal{H}$  are extended respectively by

$$D\vec{G}^L = \vec{G}^{DL(u^v)}$$

and

$$\int_{\Delta} \vec{G}^L = \int_{\Delta} K(\mathbf{x}, \mathbf{y})\vec{G}^{L[\mathbf{y}]}d\mathbf{y} = \vec{G}^{\int_{\Delta} K(\mathbf{x}, \mathbf{y})L(u^v)[\mathbf{y}]d\mathbf{y}},$$

for  $\forall (u, v) \in E(\vec{G})$ , where  $a_i, \frac{\partial a_i}{\partial x_j} \in \mathbb{C}^0(\Delta)$  for integers  $1 \leq i, j \leq n$  and  $K(\mathbf{x}, \mathbf{y}) : \Delta \times \Delta \rightarrow \mathbb{C} \in L^2(\Delta \times \Delta, \mathbb{C})$  with

$$\int_{\Delta \times \Delta} K(\mathbf{x}, \mathbf{y})d\mathbf{x}d\mathbf{y} < \infty.$$

Clearly,

$$\begin{aligned} D(\lambda \vec{G}^{L_1(v,u)} + \mu \vec{G}^{L_2(v,u)}) &= D(\vec{G}^{\lambda L_1(v,u) + \mu L_2(v,u)}) \\ &= \vec{G}^{D(\lambda L_1(v,u) + \mu L_2(v,u))} = \vec{G}^{D(\lambda L_1(v,u)) + D(\mu L_2(v,u))} \\ &= \vec{G}^{D(\lambda L_1(v,u))} + \vec{G}^{D(\mu L_2(v,u))} = D(\vec{G}^{(\lambda L_1(v,u))} + \vec{G}^{(\mu L_2(v,u))}) \\ &= \lambda D(\vec{G}^{L_1(v,u)}) + D(\mu \vec{G}^{L_2(v,u)}) \end{aligned}$$

for  $\vec{G}^{L_1}, \vec{G}^{L_2} \in \vec{G}^{\mathcal{H}}$  and  $\lambda, \mu \in \mathbb{R}$ , i.e.,

$$D \left( \lambda \vec{G}^{L_1} + \mu \vec{G}^{L_2} \right) = \lambda D \vec{G}^{L_1} + \mu D \vec{G}^{L_2}.$$

Similarly, we can show also that

$$\int_{\Delta} \left( \lambda \vec{G}^{L_1} + \mu \vec{G}^{L_2} \right) = \lambda \int_{\Delta} \vec{G}^{L_1} + \mu \int_{\Delta} \vec{G}^{L_2},$$

i.e., the operators  $D$  and  $\int_{\Delta}$  are linear.

Notice that  $\vec{G}^{L(v,u)} \in \vec{G}^{\mathcal{H}}$ , there must be

$$\sum_{u \in N_G(v)} L(v, u) = \mathbf{0} \quad \text{for } \forall v \in V(\vec{G}),$$

We therefore know that

$$\mathbf{0} = D \left( \sum_{u \in N_G(v)} L(v, u) \right) = \sum_{u \in N_G(v)} DL(v, u)$$

and

$$\mathbf{0} = \int_{\Delta} \left( \sum_{u \in N_G(v)} L(v, u) \right) = \sum_{u \in N_G(v)} \int_{\Delta} L(v, u)$$

for  $\forall v \in V(\vec{G})$ . Consequently,

$$D : \vec{G}^{\mathcal{H}} \rightarrow \vec{G}^{\mathcal{H}}, \quad \text{and} \quad \int_{\Delta} : \vec{G}^{\mathcal{H}} \rightarrow \vec{G}^{\mathcal{H}}$$

are linear operators on  $\vec{G}^{\mathcal{H}}$ .

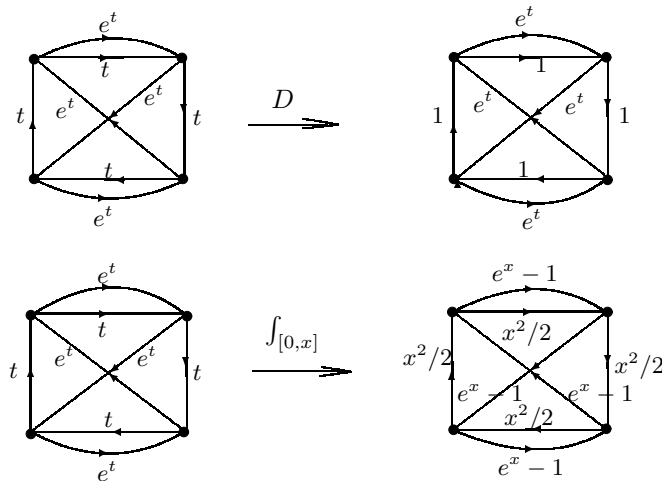

Fig.15

For example, let  $f(t) = t$ ,  $g(t) = e^t$ ,  $K(t, \tau) = 1$  on  $\Delta = [0, x]$  and let  $\vec{G}^L$  be the  $\vec{G}$ -flow shown on the left side in Fig.15. Calculation shows that  $Df = 1$ ,  $Dg = e^t$ ,

$$\int_0^x K(t, \tau) f(\tau) d\tau = \int_0^x \tau d\tau = \frac{x^2}{2}, \quad \int_0^x K(t, \tau) g(\tau) d\tau = \int_0^x e^\tau d\tau = e^x - 1$$

and the actions  $D\vec{G}^L$ ,  $\int_{[0,1]} \vec{G}^L$  are shown on the right in Fig.15.

Particularly, the Cauchy problem on heat equation

$$\frac{\partial u}{\partial t} = c^2 \sum_{i=1}^n \frac{\partial^2 u}{\partial x_i^2}$$

is solvable in  $\mathbb{R}^n \times \mathbb{R}$  if  $u(\mathbf{x}, t_0) = \varphi(\mathbf{x})$  is continuous and bounded in  $\mathbb{R}^n$ , and  $c$  is a non-zero constant in  $\mathbb{R}$ . Certainly, we can also consider the Cauchy problem in  $\vec{G}^{\mathcal{H}}$ , i.e.,

$$\frac{\partial X}{\partial t} = c^2 \sum_{i=1}^n \frac{\partial^2 X}{\partial x_i^2}$$

with initial values  $X|_{t=t_0}$ , and get the following result.

**Theorem 4.4**([18]) For  $\forall \vec{G}^{L'} \in \vec{G}^{\mathbb{R}^n \times \mathbb{R}}$  and a non-zero constant  $c$  in  $\mathbb{R}$ , the Cauchy problems on differential equations

$$\frac{\partial X}{\partial t} = c^2 \sum_{i=1}^n \frac{\partial^2 X}{\partial x_i^2}$$

with initial value  $X|_{t=t_0} = \vec{G}^{L'} \in \vec{G}^{\mathbb{R}^n \times \mathbb{R}}$  is solvable in  $\vec{G}^{\mathbb{R}^n \times \mathbb{R}}$  if  $L'(v, u)$  is continuous and bounded in  $\mathbb{R}^n$  for  $\forall (v, u) \in E(\vec{G})$ .

Fortunately, if the graph  $\vec{G}$  is prescribed with special structures, for instance the circuit decomposable, we can always solve the Cauchy problem on an equation in Hilbert  $\vec{G}$ -flow space  $\vec{G}^{\mathcal{H}}$  if this equation is solvable in  $\mathcal{H}$ .

**Theorem 4.5**([18], [22]) If the graph  $\vec{G}$  is strong-connected with circuit decomposition

$$\vec{G} = \bigcup_{i=1}^l \vec{C}_i$$

such that  $L(v, u) = L_i(\mathbf{x})$  for  $\forall (v, u) \in E(\vec{C}_i)$ ,  $1 \leq i \leq l$  and the Cauchy problem

$$\begin{cases} \mathcal{F}_i(\mathbf{x}, u, u_{x_1}, \dots, u_{x_n}, u_{x_1 x_2}, \dots) = 0 \\ u|_{\mathbf{x}_0} = L_i(\mathbf{x}) \end{cases}$$

is solvable in a Hilbert space  $\mathcal{H}$  on domain  $\Delta \subset \mathbb{R}^n$  for integers  $1 \leq i \leq l$ , then the Cauchy

problem

$$\begin{cases} \mathcal{F}_i(\mathbf{x}, X, X_{x_1}, \dots, X_{x_n}, X_{x_1x_2}, \dots) = 0 \\ X|_{\mathbf{x}_0} = \vec{G}^L \end{cases}$$

such that  $L(v, u) = L_i(\mathbf{x})$  for  $\forall(v, u) \in X(\vec{C}_i)$  is solvable for  $X \in \vec{G}^{\mathcal{H}}$ .

### §5. Applications

Notice that labeled graph combines the discrete with that of analytic mathematics. This character implies that it can be used as a model for living things in the nature and contributes to system control, gravitational field, interaction fields, economics, traffic flows, ecology, epidemiology and other sciences. But we only mention 2 applications of labeled graphs for limitation of the space, i.e., global stability and spacetime in this section. More its applications can be found in references [6]-[7], [13]-[23].

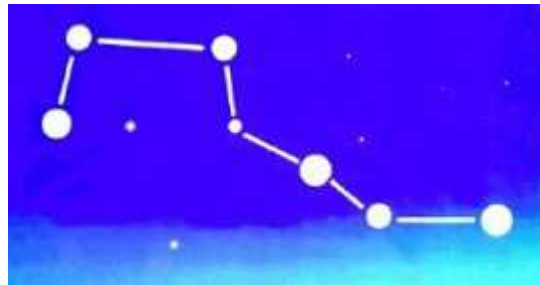

Fig.16

#### 5.1 Global Stability

The stability of systems characterized by differential equations ( $ES_m$ ) addresses the stability of solutions of ( $ES_m$ ) and the trajectories of systems with small perturbations on initial values, such as those shown for Big Dipper in Fig.16.

In mathematics, a solution of system ( $ES_m$ ) of differential equations is called stable or asymptotically stable ([25]) if for all solutions  $Y(t)$  of the differential equations ( $ES_m$ ) with

$$|Y(0) - X(0)| < \delta(\varepsilon),$$

exists for all  $t \geq 0$ ,

$$|Y(t) - X(t)| < \varepsilon$$

for  $\forall \varepsilon > 0$  or furthermore,

$$\lim_{t \rightarrow 0} |Y(t) - X(t)| = 0.$$

However, by Theorem 2.9 if  $\bigcap_{i=1}^m S_{T_i} = \emptyset$  there are no solutions of ( $ES_m$ ). Thus, the classical theory of stability is failed to apply. Then *how can one characterizes the stability of system*

$(ES_m)$ ? As we have shown in Subsection 2.4, we always get a labeled graph solution  $G^L[ES_m]$  of system  $(ES_m)$  whenever it is solvable or not, which can be applied to characterize the stability of system  $(ES_m)$ .

Without loss of generality, assume  $G^L(t)$  be a solution of  $(ES_m)$  with initial values  $G^L(t_0)$  and let  $\omega : V(G^L[ES_m]) \rightarrow \mathbb{R}$  be an index function. It is said to be  $\omega$ -stable if there exists a number  $\delta(\varepsilon)$  for any number  $\varepsilon > 0$  such that

$$\left\| \omega \left( G^{L_1(t) - L_2(t)} \right) \right\| < \varepsilon,$$

or furthermore, *asymptotically  $\omega$ -stable* if

$$\lim_{t \rightarrow \infty} \left\| \omega \left( G^{L_1(t) - L_2(t)} \right) \right\| = 0$$

if initial values hold with

$$\|L_1(t_0)(v) - L_2(t_0)(v)\| < \delta(\varepsilon)$$

for  $\forall v \in V(\vec{G})$ . If there is a Liapunov  $\omega$ -function  $L(\omega(t)) : \mathcal{O} \rightarrow \mathbb{R}, n \geq 1$  on  $\vec{G}$  with  $\mathcal{O} \subset \mathbb{R}^n$  open such that  $L(\omega(t)) \geq 0$  with equality hold only if  $(x_1, x_2, \dots, x_n) = (0, 0, \dots, 0)$  and if  $t \geq t_0, \frac{dL(\omega)}{dt} \leq 0$ , for the  $\omega$ -stability of  $\vec{G}$ -flow, we then know a result on  $\omega$ -stability of  $(ES_m)$  following.

**Theorem 5.1**([22]) *If there is a Liapunov  $\omega$ -function  $L(\omega(t)) : \mathcal{O} \rightarrow \mathbf{R}$  on  $G^L[ES_m]$  of system  $(ES_m)$ , then  $G^L[ES_m]$  is  $\omega$ -stable, and furthermore, if  $\dot{L}(\omega(t)) < 0$  for  $G^L[ES_m] \neq G^0[ES_m]$ , then  $G^L[ES_m]$  is asymptotically  $\omega$ -stable.*

For linear differential equations  $(LDES_m^1)$ , we can further introduce the sum-table subgraph following.

**Definition 5.2** *Let  $H^L$  be a spanning subgraph of  $G^L[LDES_m^1]$  of systems  $(LDES_m^1)$  with initial value  $X_v(0), v \in V(G[LDES_m^1])$ . Then  $G^L[LDES_m^1]$  is called sum-stable or asymptotically sum-stable on  $H^L$  if for all solutions  $Y_v(t), v \in V(H^L)$  of the linear differential equations of  $(LDES_m^1)$  with  $|Y_v(0) - X_v(0)| < \delta_v$  exists for all  $t \geq 0$ ,*

$$\left| \sum_{v \in V(H^L)} Y_v(t) - \sum_{v \in V(H^L)} X_v(t) \right| < \varepsilon,$$

or furthermore,

$$\lim_{t \rightarrow 0} \left| \sum_{v \in V(H^L)} Y_v(t) - \sum_{v \in V(H^L)} X_v(t) \right| = 0.$$

We get a result on the global stability for  $G$ -solutions of  $(LDES_m^1)$  following.

**Theorem 5.3**([13]) *A labeled graph solution  $G^0[LDES_m^1]$  of linear homogenous differential equation systems  $(LDES_m^1)$  is asymptotically sum-stable on a spanning subgraph  $H^L$  of*

$G^L[LDES_m^1]$  if and only if  $\text{Re}\alpha_v < 0$  for each  $\bar{\beta}_v(t)e^{\alpha_v t} \in \mathcal{B}_v, \forall v \in V(H^L)$  in  $G^L[LDES_m^1]$ .

**Example 5.4** Let a labeled graph solution  $G^L[LDES_m^1]$  of  $(LDES_m^1)$  be shown in Fig.17, where  $v_1 = \{e^{-2t}, e^{-3t}, e^{3t}\}, v_2 = \{e^{-3t}, e^{-4t}\}, v_3 = \{e^{-4t}, e^{-5t}, e^{3t}\}, v_4 = \{e^{-5t}, e^{-6t}, e^{-8t}\}, v_5 = \{e^{-t}, e^{-6t}\}, v_6 = \{e^{-t}, e^{-2t}, e^{-8t}\}$ . Then the labeled graph solution  $G^0[LDES_m^1]$  is sum-stable on the labeled triangle  $v_4v_5v_6$  but not on the triangle  $v_1v_2v_3$ .

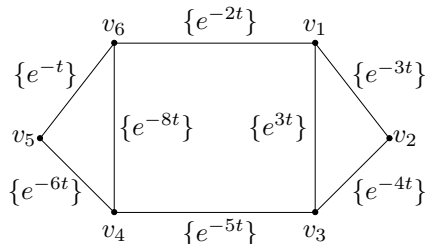

Fig.17

Similarly, let the system  $(PDES_m^C)$  of linear partial differential equations be

$$\left. \begin{aligned} \frac{\partial u}{\partial t} &= H_i(t, x_1, \dots, x_{n-1}, p_1, \dots, p_{n-1}) \\ u|_{t=t_0} &= u_0^{[i]}(x_1, x_2, \dots, x_{n-1}) \end{aligned} \right\} 1 \leq i \leq m \quad (APDES_m^C)$$

A point  $X_0^{[i]} = (t_0, x_{10}^{[i]}, \dots, x_{(n-1)0}^{[i]})$  with  $H_i(t_0, x_{10}^{[i]}, \dots, x_{(n-1)0}^{[i]}) = 0$  for  $1 \leq i \leq m$  is called an *equilibrium point* of the  $i$ th equation in  $(APDES_m^C)$ . Then we know the following result, which can be applied to the ecological mathematics for the number of species  $\geq 3$  ([31]).

**Theorem 5.5**([17]) *Let  $X_0^{[i]}$  be an equilibrium point of the  $i$ th equation in  $(APDES_m^C)$  for integers  $1 \leq i \leq m$ . If  $\sum_{i=1}^m H_i(X) > 0$  and  $\sum_{i=1}^m \frac{\partial H_i}{\partial t} \leq 0$  for  $X \neq \sum_{i=1}^m X_0^{[i]}$ , then the labeled graph solution  $G^L[APDES_m^C]$  of system  $(APDES_m^C)$  is sum-stable. Furthermore, if  $\sum_{i=1}^m \frac{\partial H_i}{\partial t} < 0$  for  $X \neq \sum_{i=1}^m X_0^{[i]}$ , then the labeled graph solution  $G^L[APDES_m^C]$  of system  $(APDES_m^C)$  is asymptotically sum-stable.*

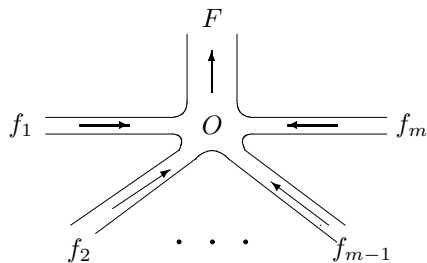

Fig.18

An immediately application of Theorem 5.5 is the control of traffic flows. For example, let  $O$  be a node in  $N$  incident with  $m$  in-flows and 1 out-flow such as those shown in Fig.18. Then,

what conditions will make sure the flow  $F$  being stable? Denote the density of flow  $F$  by  $\rho^{[F]}$  and  $f_i$  by  $\rho^{[i]}$  for integers  $1 \leq i \leq m$ , respectively. Then, by traffic theory,

$$\frac{\partial \rho^{[i]}}{\partial t} + \phi_i(\rho^{[i]}) \frac{\partial \rho^{[i]}}{\partial x} = 0, \quad 1 \leq i \leq m.$$

We prescribe the initial value of  $\rho^{[i]}$  by  $\rho^{[i]}(x, t_0)$  at time  $t_0$ . Replacing each  $\rho^{[i]}$  by  $\rho$  in these flow equations of  $f_i$ ,  $1 \leq i \leq m$ , we get a non-solvable system ( $PDES_m^C$ ) of partial differential equations

$$\left. \begin{aligned} \frac{\partial \rho}{\partial t} + \phi_i(\rho) \frac{\partial \rho}{\partial x} &= 0 \\ \rho|_{t=t_0} &= \rho^{[i]}(x, t_0) \end{aligned} \right\} 1 \leq i \leq m.$$

Denote an equilibrium point of the  $i$ th equation by  $\rho_0^{[i]}$ , i.e.,  $\phi_i(\rho_0^{[i]}) \frac{\partial \rho_0^{[i]}}{\partial x} = 0$ . By Theorem 5.5, if

$$\sum_{i=1}^m \phi_i(\rho) < 0 \quad \text{and} \quad \sum_{i=1}^m \phi_i(\rho) \left[ \frac{\partial^2 \rho}{\partial t \partial x} - \phi'(\rho) \left( \frac{\partial \rho}{\partial x} \right)^2 \right] \geq 0$$

for  $X \neq \sum_{k=1}^m \rho_0^{[k]}$ , then the flow  $F$  is stable, and furthermore, if

$$\sum_{i=1}^m \phi_i(\rho) \left[ \frac{\partial^2 \rho}{\partial t \partial x} - \phi'(\rho) \left( \frac{\partial \rho}{\partial x} \right)^2 \right] < 0$$

for  $X \neq \sum_{k=1}^m \rho_0^{[k]}$ , it is asymptotically stable.

### 5.2 Spacetime

Usually, different spacetime determine different structure of the universe, particularly for the solutions of Einstein's gravitational equations

$$R^{\mu\nu} - \frac{1}{2} R g^{\mu\nu} + \lambda g^{\mu\nu} = -8\pi G T^{\mu\nu},$$

where  $R^{\mu\nu} = R_{\alpha}^{\mu\alpha\nu} = g_{\alpha\beta} R^{\alpha\mu\beta\nu}$ ,  $R = g_{\mu\nu} R^{\mu\nu}$  are the respective Ricci tensor, Ricci scalar curvature,  $G = 6.673 \times 10^{-8} \text{cm}^3/\text{gs}^2$ ,  $\kappa = 8\pi G/c^4 = 2.08 \times 10^{-48} \text{cm}^{-1} \cdot \text{g}^{-1} \cdot \text{s}^2$  ([24]).

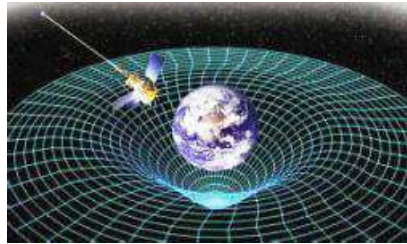

Fig.19

Certainly, Einstein's general relativity is suitable for use only in one spacetime  $\mathbb{R}^4$ , which



implies a curved spacetime shown in Fig.19. But, if the dimension of the universe  $> 4$ ,

*How can we characterize the structure of spacetime for the universe?*

Generally, we understand a thing by observation, i.e., the received information via hearing, sight, smell, taste or touch of our sensory organs and verify results on it in  $\mathbb{R}^3 \times \mathbb{R}$ . If the dimension of the universe  $> 4$ , all these observations are nothing else but a projection of the true faces on our six organs, a partially truth. As a discrete mathematician, the combinatorial notion should be his world view. A combinatorial spacetime  $(\mathcal{C}_G|\vec{t})$  ([7]) is in fact a graph  $G^L$  labeled by Euclidean spaces  $\mathbb{R}^n, n \geq 3$  evolving on a time vector  $\vec{t}$  under smooth conditions in geometry. We can characterize the spacetime of the universe by a complete graph  $K_m^L$  labeled by  $\mathbb{R}^4$  (See [9]-[11] for details).

For example, if  $m = 4$ , there are 4 Einstein's gravitational equations for  $\forall v \in V(K_4^L)$ . We solve it locally by spherically symmetric solutions in  $\mathbb{R}^4$  and construct a graph  $K_4^L$ -solution labeled by  $S_{f_1}, S_{f_2}, S_{f_3}$  and  $S_{f_4}$  of Einstein's gravitational equations, such as those shown in Fig.20,

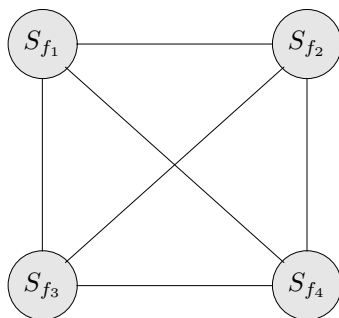

**Fig.20**

where, each  $S_{f_i}$  is a geometrical space determined by Schwarzschild spacetime

$$ds^2 = f(t) \left(1 - \frac{r_s}{r}\right) dt^2 - \frac{1}{1 - \frac{r_s}{r}} dr^2 - r^2(d\theta^2 + \sin^2 \theta d\phi^2)$$

for integers  $1 \leq i \leq 4$ . Certainly, its global behavior depends on the intersections  $S_{f_i} \cap S_{f_j}, 1 \leq i \neq j \leq 4$ .

Notice that  $m = 4$  is only an assumption. We do not know the exact value of  $m$  at present. Similarly, by Theorem 4.5, we also get a conclusion on spacetime of the Einstein's gravitational equations and we do not know also which labeled graph structure is the real spacetime of the universe.

**Theorem 5.6**([17]) *There are infinite many  $\vec{G}$ -flow solutions on Einstein's gravitational equations*

$$R^{\mu\nu} - \frac{1}{2}Rg^{\mu\nu} = -8\pi GT^{\mu\nu}$$

in  $\vec{G}^C$ , particularly on those graphs with circuit-decomposition  $\vec{G} = \bigcup_{i=1}^m \vec{C}_i$  with Schwarzschild spacetime on their edges.

For example, let  $\vec{G} = \vec{C}_4$ . We easily find  $\vec{C}_4$ -flow solution of Einstein’s gravitational equations such as those shown in Fig.21.

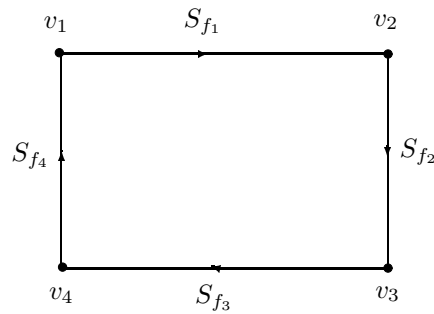

Fig.21

Then, the spacetime of the universe is nothing else but a curved ring such as those shown in Fig.22.

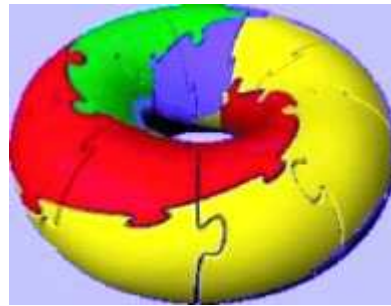

Fig.22

Generally, if  $\vec{G}$  can be decomposed into  $m$  orientated circuits  $\vec{C}_i$ ,  $1 \leq i \leq m$ , then Theorem 5.6 implies such a spacetime of Einstein’s gravitational equations consisting of  $m$  curved rings over graph  $\vec{G}$  in space.

**§6. Conclusion**

What are the elements of mathematics? Certainly, the mathematics consists of elements, include numbers  $1, 2, 3, \dots$ , maps, functions  $f(\mathbf{x})$ , vectors, matrices, points, lines, opened sets  $\dots$ , etc. with relations. However, these elements are not enough for understanding the reality of things because they must be a system without contradictions in its subfield of classical mathematics, i.e., a compatible system but contradictions exist everywhere, things are all in full of contradiction in the world. Thus, turn a systems with contradictions to mathematics is an important step for hold on the reality of things in the world. For such an objective, labeled

graphs  $G^L$  are elements because a non-mathematics in classical is in fact a mathematics over a graph  $G$  ([16]), i.e., mathematical combinatorics. Thus, we should pay more attentions to labeled graphs, not only as a labeling technique on graphs but also a really mathematical element.

## References

- [1] F.Smarandache, *Paradoxist Geometry*, State Archives from Valcea, Rm. Valcea, Romania, 1969, and in *Paradoxist Mathematics*, Collected Papers (Vol. II), Kishinev University Press, Kishinev, 5-28, 1997.
- [2] Fritz John, *Partial Differential Equations*, New York, USA: Springer-Verlag, 1982.
- [3] H.Everett, Relative state formulation of quantum mechanics, *Rev.Mod.Phys.*, 29(1957), 454-462.
- [4] G.J.Gallian, A dynamic survey of graph labeling, *The Electronic Journal of Combinatorics*, 12(2012), #DS6.
- [5] John B.Conway, *A Course in Functional Analysis*, Springer-Verlag New York,Inc., 1990.
- [6] Linfan Mao, Combinatorial fields – An introduction, *International J. Math. Combin.*, Vol.1(2009), Vol.3, 1-22.
- [7] Linfan Mao, Relativity in combinatorial gravitational fields, *Progress in Physics*, Vol.3(2010), 39-50.
- [8] Linfan Mao, A combinatorial decomposition of Euclidean spaces  $R^n$  with contribution to visibility, *International J. Math. Combin.*, Vol.1, 2010, 47-64.
- [9] Linfan Mao, *Automorphism Groups of Maps, Surfaces and Smarandache Geometries*, The Education Publisher Inc., USA, 2011.
- [10] Linfan Mao, *Smarandache Multi-Space Theory*, The Education Publisher Inc., USA, 2011.
- [11] Linfan Mao, *Combinatorial Geometry with Applications to Field Theory*, The Education Publisher Inc., USA, 2011.
- [12] Linfan Mao, Non-solvable spaces of linear equation systems, *International J.Math. Combin.*, Vol.2(2012), 9-23
- [13] Linfan Mao, Global stability of non-solvable ordinary differential equations with applications, *International J.Math. Combin.*, Vol.1 (2013), 1-37.
- [14] Linfan Mao, Non-solvable equation systems with graphs embedded in  $\mathbf{R}^n$ , *Proceedings of the First International Conference on Smarandache Multispace and Multistructure*, The Education Publisher Inc. July, 2013
- [15] Linfan Mao, Geometry on  $G^L$ -systems of homogenous polynomials, *International J.Contemp. Math. Sciences*, Vol.9 (2014), No.6, 287-308.
- [16] Linfan Mao, Mathematics on non-mathematics - A combinatorial contribution, *International J.Math. Combin.*, Vol.3(2014), 1-34.
- [17] Linfan Mao, Cauchy problem on non-solvable system of first order partial differential equations with applications, *Methods and Applications of Analysis*, Vol.22, 2(2015), 171-200.
- [18] Linfan Mao, Extended Banach  $\vec{G}$ -flow spaces on differential equations with applications, *Electronic J.Mathematical Analysis and Applications*, Vol.3, No.2 (2015), 59-91.

- [19] Linfan Mao, A new understanding of particles by  $\vec{G}$ -flow interpretation of differential equation, *Progress in Physics*, Vol.11(2015), 193-201.
- [20] Linfan Mao, A review on natural reality with physical equation, *Progress in Physics*, Vol.11(2015), 276-282.
- [21] Linfan Mao, Mathematics after CC conjecture – combinatorial notions and achievements, *International J.Math. Combin.*, Vol.2(2015), 1-31.
- [22] Linfan Mao, Mathematics with natural reality – Action Flows, *Bull.Cal.Math.Soc.*, Vol.107, 6(2015), 443-474.
- [23] M.A.Perumal, S.Navaneethakrishnan and A.Nagarajan, Lucas graceful labeling for some graphs, *International J.Math. Combin.*, Vol.1 (2011), 01-19.
- [24] M.Carmeli, *Classical Fields–General Relativity and Gauge Theory*, World Scientific, 2001.
- [25] Morris W.Hirsch, Stephen Smale and Robert L.Devaney, *Differential Equations, Dynamical Systems & An introduction to Chaos* (Second Edition), Elsevier (Singapore) Pte Ltd, 2006.
- [26] P.Siva Kota Reddy and M.S.Subramanya, Signed graph equation  $L^K(S) \sim \overline{S}$ , *International J.Math. Combin.*, Vol.4 (2009), 84-88.
- [27] Quang Ho-Kim and Pham Xuan Yem, *Elementary Particles and Their Interactions*, Springer-Verlag Berlin Heidelberg, 1998.
- [28] R.Ponraj, M.Maria Adaickalam and R.Kala, Quotient cordial labeling of graphs, *International J.Math. Combin.*, Vol.1(2016), 101-108.
- [29] Selvam Avadayappan and R.Vasuki, New families of mean graphs, *International J.Math. Combin.*, Vol.2 (2010), 68-80.
- [30] Ullas Thomas and Sunil C.Mathew, On set-semigraceful graphs, *International J.Math. Combin.*, Vol.2(2012), 59-70.
- [31] Y.Lou, Some reaction diffusion models in spatial ecology (in Chinese), *Sci.Sin. Math.*, Vol.45(2015), 1619-1634.
- [32] Y.Nambu, *Quarks: Frontiers in Elementary Particle Physics*, World Scientific Publishing Co.Pte.Ltd, 1985.

## Chapter 5 Combinatorial Models on Reality



*That is the essence of science: ask an impertinent question, and you are on the way to the pertinent answer.*

By Jacob Bronowski, a Polish-born British mathematician.

## **Combinatorial Field - An Introduction**

*Dedicated to Prof. Feng Tian on his 70th Birthday*

**Abstract:** A *combinatorial field*  $\mathcal{W}_G$  is a multifield underlying a graph  $G$ , established on a smoothly combinatorial manifold. This paper first presents a quick glance to its mathematical basis with motivation, such as those of *why the WORLD is combinatorial?* and *what is a topological or differentiable combinatorial manifold?* After then, we explain how to construct principal fiber bundles on combinatorial manifolds by the voltage assignment technique, and how to establish differential theory, for example, connections on combinatorial manifolds. We also show applications of combinatorial fields to other sciences in this paper.

**Key Words:** Combinatorial field, Smarandache multi-space, combinatorial manifold, WORLD, principal fiber bundle, gauge field.

**AMS(2000):** 51M15, 53B15, 53B40, 57N16, 83C05, 83F05.

### **§1. Why is the WORLD a Combinatorial One?**

The multiplicity of the WORLD results in modern sciences overlap and hybrid, also implies its combinatorial structure. To see more clear, we present two meaningful proverbs following.

#### **Proverb 1. Ames Room**

An Ames room is a distorted room constructed so that from the front it appears to be an ordinary cubic-shaped room, with a back wall and two side walls parallel to each other and perpendicular to the horizontally level floor and ceiling. As a result of the optical illusion, a person standing in one corner appears to the observer to be a giant, while a person standing in the other corner appears to be a dwarf. The illusion is convincing enough that a person walking back and forth from the left corner to the right corner appears to grow or shrink. For details, see Fig.1 below. This proverb means that it is not all right by our visual sense for the multiplicity of world.

---

<sup>1</sup>Reported at Nanjing Normal University, October 3-4, 2009.

<sup>2</sup>*International J.Math. Combin.*, Vol.3 (2009), 01-22

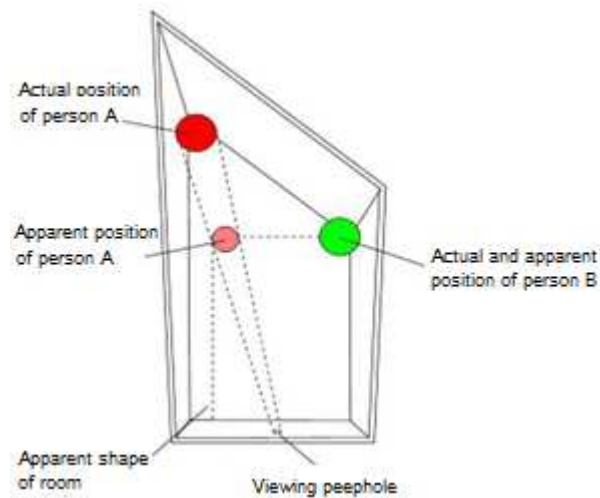

Fig.1

**Proverb 2.** *Blind men with an elephant*

In this proverb, there are six blind men were be asked to determine what an elephant looked like by feeling different parts of the elephant's body, seeing Fig.2 following. The man touched the elephant's leg, tail, trunk, ear, belly or tusk claims it's like a pillar, a rope, a tree branch, a hand fan, a wall or a solid pipe, respectively. They then entered into an endless argument and each of them insisted his view right.



Fig.2

*All of you are right!* A wise man explains to them: *Why are you telling it differently is because each one of you touched the different part of the elephant. So, actually the elephant has all those features what you all said.* Then

*What is the meaning of Proverbs 1 and 2 for understanding the structure of WORLD?*

The situation for one realizing behaviors of the WORLD is analogous to the observer in Ames room or these blind men in the second proverb. In fact, we can distinguish the WORLD by known or unknown parts simply, such as those shown in Fig.3.

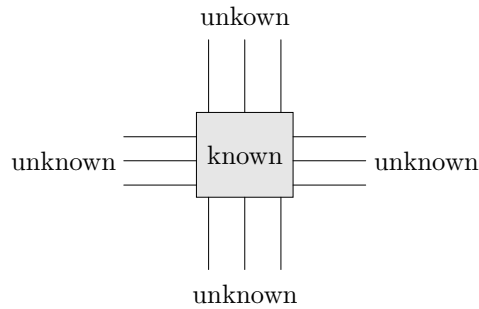

Fig.3

The laterality of human beings implies that one can only determines lateral feature of the WORLD by our technology. Whence, the WORLD should be the union of all characters determined by human beings, i.e., a Smarandache multi-space underlying a combinatorial structure in logic. Then *what can we say about the unknown part of the WORLD? Is it out order?* No! It must be in order for any thing having its own right for existing. Therefore, these is an underlying combinatorial structure in the WORLD by the *combinatorial notion*, shown in Fig.4.

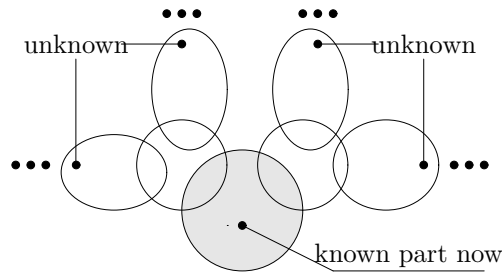

Fig.4

In fact, this combinatorial notion for the WORLD can be applied for all sciences. I presented this combinatorial notion in Chapter 5 of [8], then formally as the *CC conjecture for mathematics* in [11], which was reported at *the 2nd Conference on Combinatorics and Graph Theory of China* in 2006.

**Combinatorial Conjecture** *A mathematical science can be reconstructed from or made by combinatorialization.*

This conjecture opens an entirely way for advancing the modern sciences. It indeed means a deeply *combinatorial notion* on mathematical objects following for researchers.

- (i) There is a combinatorial structure and finite rules for a classical mathematical system, which means one can make combinatorialization for all classical mathematical subjects.
- (ii) One can generalizes a classical mathematical system by this combinatorial notion such



that it is a particular case in this generalization.

(iii) One can make one combination of different branches in mathematics and find new results after then.

(iv) One can understand our WORLD by this combinatorial notion, establish combinatorial models for it and then find its behavior, and so on.

This combinatorial notion enables ones to establish a combinatorial model for the WORLD and develop modern sciences combinatorially. Whence, a science can not be ended if its combinatorialization has not completed yet.

## §2. Topological Combinatorial Manifold

Now *how can we characterize these unknown parts in Fig.1.4 by mathematics?* Certainly, these unknown parts can be also considered to be fields. Today, we have known a best tool for understanding the known field, i.e., a topological or differentiable manifold in geometry ([1], [2]). So it is more natural to think each unknown part is itself a manifold. That is the motivation of combinatorial manifolds.

Loosely speaking, a combinatorial manifold is a combination of finite manifolds, such as those shown in Fig.5.

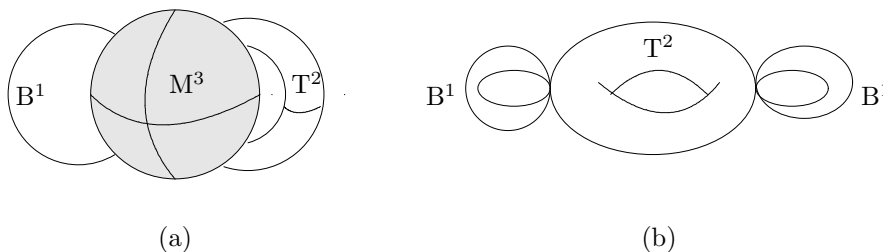

**Fig.5**

In where (a) represents a combination of a 3-manifold, a torus and 1-manifold, and (b) a torus with 4 bouquets of 1-manifolds.

### 2.1 Euclidean Fan-Space

A *combinatorial Euclidean space* is a combinatorial system  $\mathcal{C}_G$  of Euclidean spaces  $\mathbf{R}^{n_1}, \mathbf{R}^{n_2}, \dots, \mathbf{R}^{n_m}$  underlying a connected graph  $G$  defined by

$$V(G) = \{\mathbf{R}^{n_1}, \mathbf{R}^{n_2}, \dots, \mathbf{R}^{n_m}\},$$

$$E(G) = \{(\mathbf{R}^{n_i}, \mathbf{R}^{n_j}) \mid \mathbf{R}^{n_i} \cap \mathbf{R}^{n_j} \neq \emptyset, 1 \leq i, j \leq m\},$$

denoted by  $\mathcal{E}_G(n_1, \dots, n_m)$  and abbreviated to  $\mathcal{E}_G(r)$  if  $n_1 = \dots = n_m = r$ , which enables us to view an Euclidean space  $\mathbf{R}^n$  for  $n \geq 4$ . Whence it can be used for models of spacetime in physics.

A *combinatorial fan-space*  $\tilde{\mathbf{R}}(n_1, \dots, n_m)$  is the combinatorial Euclidean space  $\mathcal{E}_{K_m}(n_1, \dots, n_m)$

of  $\mathbf{R}^{n_1}, \mathbf{R}^{n_2}, \dots, \mathbf{R}^{n_m}$  such that for any integers  $i, j, 1 \leq i \neq j \leq m$ ,

$$\mathbf{R}^{n_i} \cap \mathbf{R}^{n_j} = \bigcap_{k=1}^m \mathbf{R}^{n_k}.$$

A combinatorial fan-space is in fact a  $p$ -brane with  $p = \dim \bigcap_{k=1}^m \mathbf{R}^{n_k}$  in *String Theory* ([21], [22]), seeing Fig.6 for details.

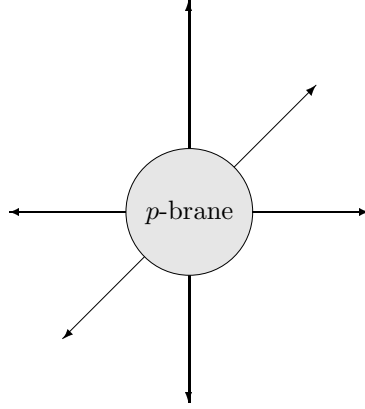

Fig.6

For  $\forall p \in \widetilde{\mathbf{R}}(n_1, \dots, n_m)$  we can present it by an  $m \times n_m$  coordinate matrix  $[\bar{x}]$  following with  $x_{il} = \frac{x_l}{m}$  for  $1 \leq i \leq m, 1 \leq l \leq \widehat{m}$ ,

$$[\bar{x}] = \begin{bmatrix} x_{11} & \cdots & x_{1\widehat{m}} & x_{1(\widehat{m}+1)} & \cdots & x_{1n_1} & \cdots & 0 \\ x_{21} & \cdots & x_{2\widehat{m}} & x_{2(\widehat{m}+1)} & \cdots & x_{2n_2} & \cdots & 0 \\ \cdots & \cdots & \cdots & \cdots & \cdots & \cdots & \cdots & \cdots \\ x_{m1} & \cdots & x_{m\widehat{m}} & x_{m(\widehat{m}+1)} & \cdots & \cdots & x_{mn_{m-1}} & x_{mn_m} \end{bmatrix}.$$

Let  $\mathcal{M}_{n \times s}$  denote all  $n \times s$  matrixes for integers  $n, s \geq 1$ . We introduce the *inner product*  $\langle\langle (A), (B) \rangle\rangle$  for  $(A), (B) \in \mathcal{M}_{n \times s}$  by

$$\langle\langle (A), (B) \rangle\rangle = \sum_{i,j} a_{ij} b_{ij}.$$

Then we easily know that  $\mathcal{M}_{n \times s}$  forms an Euclidean space under such product.

## 2.2 Topological Combinatorial Manifold

For a given integer sequence  $0 < n_1 < n_2 < \dots < n_m, m \geq 1$ , a *combinatorial manifold*  $\widetilde{M}$  is a *Hausdorff space* such that for any point  $p \in \widetilde{M}$ , there is a local chart  $(U_p, \varphi_p)$  of  $p$ , i.e., an open neighborhood  $U_p$  of  $p$  in  $\widetilde{M}$  and a homoeomorphism  $\varphi_p : U_p \rightarrow \widetilde{\mathbf{R}}(n_1(p), n_2(p), \dots, n_{s(p)}(p))$ , a combinatorial fan-space with

$$\begin{aligned} \{n_1(p), n_2(p), \dots, n_{s(p)}(p)\} &\subseteq \{n_1, n_2, \dots, n_m\}, \\ \bigcup_{p \in \widetilde{M}} \{n_1(p), n_2(p), \dots, n_{s(p)}(p)\} &= \{n_1, n_2, \dots, n_m\}, \end{aligned}$$

denoted by  $\widetilde{M}(n_1, n_2, \dots, n_m)$  or  $\widetilde{M}$  on the context and

$$\widetilde{\mathcal{A}} = \{(U_p, \varphi_p) | p \in \widetilde{M}(n_1, n_2, \dots, n_m)\}$$

an atlas on  $\widetilde{M}(n_1, n_2, \dots, n_m)$ .

A combinatorial manifold  $\widetilde{M}$  is *finite* if it is just combined by finite manifolds with an underlying combinatorial structure  $G$  without one manifold contained in the union of others. Certainly, a finitely combinatorial manifold is indeed a combinatorial manifold. Examples of combinatorial manifolds can be seen in Fig.2.1.

For characterizing topological properties of combinatorial manifolds, we need to introduced the vertex-edge labeled graph. A *vertex-edge labeled graph*  $G([1, k], [1, l])$  is a connected graph  $G = (V, E)$  with two mappings

$$\tau_1 : V \rightarrow \{1, 2, \dots, k\}, \quad \tau_2 : E \rightarrow \{1, 2, \dots, l\}$$

for integers  $k, l \geq 1$ . For example, two vertex-edge labeled graphs on  $K_4$  are shown in Fig.7.

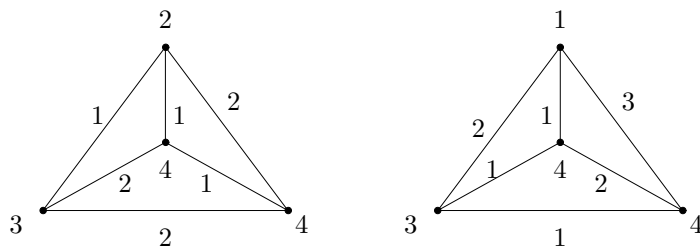

Fig.7

Let  $\widetilde{M}(n_1, n_2, \dots, n_m)$  be a finitely combinatorial manifold and  $d, d \geq 1$  an integer. We construct a vertex-edge labeled graph  $G^d[\widetilde{M}(n_1, n_2, \dots, n_m)]$  by

$$V(G^d[\widetilde{M}(n_1, n_2, \dots, n_m)]) = V_1 \cup V_2,$$

where  $V_1 = \{n_i - \text{manifolds } M^{n_i} \text{ in } \widetilde{M}(n_1, \dots, n_m) | 1 \leq i \leq m\}$  and  $V_2 = \{\text{isolated intersection points } O_{M^{n_i}, M^{n_j}} \text{ of } M^{n_i}, M^{n_j} \text{ in } \widetilde{M}(n_1, n_2, \dots, n_m) \text{ for } 1 \leq i, j \leq m\}$ . Label  $n_i$  for each  $n_i$ -manifold in  $V_1$  and 0 for each vertex in  $V_2$  and

$$E(G^d[\widetilde{M}(n_1, n_2, \dots, n_m)]) = E_1 \cup E_2,$$

where  $E_1 = \{(M^{n_i}, M^{n_j}) \text{ labeled with } \dim(M^{n_i} \cap M^{n_j}) \mid \dim(M^{n_i} \cap M^{n_j}) \geq d, 1 \leq i, j \leq m\}$  and  $E_2 = \{(O_{M^{n_i}, M^{n_j}}, M^{n_i}), (O_{M^{n_i}, M^{n_j}}, M^{n_j}) \text{ labeled with } 0 | M^{n_i} \text{ tangent } M^{n_j} \text{ at the point } O_{M^{n_i}, M^{n_j}} \text{ for } 1 \leq i, j \leq m\}$ .

Now denote by  $\mathcal{H}(n_1, n_2, \dots, n_m)$  all finitely combinatorial manifolds  $\widetilde{M}(n_1, n_2, \dots, n_m)$  and  $\mathcal{G}[0, n_m]$  all vertex-edge labeled graphs  $G^L$  with  $\theta_L : V(G^L) \cup E(G^L) \rightarrow \{0, 1, \dots, n_m\}$  with conditions following hold.

(1) Each induced subgraph by vertices labeled with 1 in  $G$  is a union of complete graphs and vertices labeled with 0 can only be adjacent to vertices labeled with 1.

(2) For each edge  $e = (u, v) \in E(G)$ ,  $\tau_2(e) \leq \min\{\tau_1(u), \tau_1(v)\}$ .

Then we know a relation between sets  $\mathcal{H}(n_1, n_2, \dots, n_m)$  and  $\mathcal{G}([0, n_m], [0, n_m])$  following.

**Theorem 2.1** *Let  $1 \leq n_1 < n_2 < \dots < n_m, m \geq 1$  be a given integer sequence. Then every finitely combinatorial manifold  $\widetilde{M} \in \mathcal{H}(n_1, n_2, \dots, n_m)$  defines a vertex-edge labeled graph  $G([0, n_m]) \in \mathcal{G}[0, n_m]$ . Conversely, every vertex-edge labeled graph  $G([0, n_m]) \in \mathcal{G}[0, n_m]$  defines a finitely combinatorial manifold  $\widetilde{M} \in \mathcal{H}(n_1, n_2, \dots, n_m)$  with a 1–1 mapping  $\theta : G([0, n_m]) \rightarrow \widetilde{M}$  such that  $\theta(u)$  is a  $\theta(u)$ -manifold in  $\widetilde{M}$ ,  $\tau_1(u) = \dim\theta(u)$  and  $\tau_2(v, w) = \dim(\theta(v) \cap \theta(w))$  for  $\forall u \in V(G([0, n_m]))$  and  $\forall (v, w) \in E(G([0, n_m]))$ .*

### 2.4 Fundamental d-Group

For two points  $p, q$  in a finitely combinatorial manifold  $\widetilde{M}(n_1, n_2, \dots, n_m)$ , if there is a sequence  $B_1, B_2, \dots, B_s$  of  $d$ -dimensional open balls with two conditions following hold.

- (1)  $B_i \subset \widetilde{M}(n_1, n_2, \dots, n_m)$  for any integer  $i, 1 \leq i \leq s$  and  $p \in B_1, q \in B_s$ ;
- (2) The dimensional number  $\dim(B_i \cap B_{i+1}) \geq d$  for  $\forall i, 1 \leq i \leq s - 1$ .

Then points  $p, q$  are called  $d$ -dimensional connected in  $\widetilde{M}(n_1, n_2, \dots, n_m)$  and the sequence  $B_1, B_2, \dots, B_s$  a  $d$ -dimensional path connecting  $p$  and  $q$ , denoted by  $P^d(p, q)$ . If each pair  $p, q$  of points in the finitely combinatorial manifold  $\widetilde{M}(n_1, n_2, \dots, n_m)$  is  $d$ -dimensional connected, then  $\widetilde{M}(n_1, n_2, \dots, n_m)$  is called  $d$ -pathwise connected and say its connectivity  $\geq d$ .

Choose a graph with vertex set being manifolds labeled by its dimension and two manifold adjacent with a label of the dimension of the intersection if there is a  $d$ -path in this combinatorial manifold. Such graph is denoted by  $G^d$ . For example, these correspondent labeled graphs gotten from finitely combinatorial manifolds in Fig.2.1 are shown in Fig.8, in where  $d = 1$  for (a) and (b),  $d = 2$  for (c) and (d).

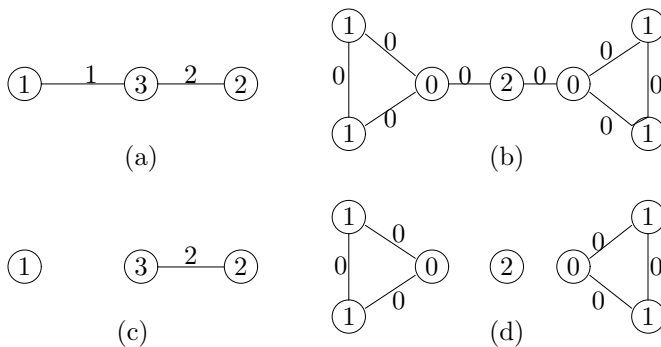

Fig.8

Let  $\widetilde{M}(n_1, n_2, \dots, n_m)$  be a finitely combinatorial manifold of  $d$ -arcwise connectedness for an integer  $d, 1 \leq d \leq n_1$  and  $\forall x_0 \in \widetilde{M}(n_1, n_2, \dots, n_m)$ , a *fundamental  $d$ -group* at the point  $x_0$ , denoted by  $\pi^d(\widetilde{M}(n_1, n_2, \dots, n_m), x_0)$  is defined to be a group generated by all homotopic classes of closed  $d$ -paths based at  $x_0$ . If  $d = 1$ , then it is obvious that  $\pi^d(\widetilde{M}(n_1, n_2, \dots, n_m), x_0)$  is the common fundamental group of  $\widetilde{M}(n_1, n_2, \dots, n_m)$  at the point  $x_0$  ([18]). For some special graphs, their fundamental  $d$ -groups can be immediately gotten, for example, the  $d$ -dimensional graphs following.

A combinatorial Euclidean space  $\mathcal{E}_G(\overbrace{d, d, \dots, d}^m)$  of  $\mathbf{R}^d$  underlying a combinatorial structure  $G, |G| = m$  is called a  *$d$ -dimensional graph*, denoted by  $\widetilde{M}^d[G]$  if

- (1)  $\widetilde{M}^d[G] \setminus V(\widetilde{M}^d[G])$  is a disjoint union of a finite number of open subsets  $e_1, e_2, \dots, e_m$ , each of which is homeomorphic to an open ball  $B^d$ ;
- (2) the boundary  $\bar{e}_i - e_i$  of  $e_i$  consists of one or two vertices  $B^d$ , and each pair  $(\bar{e}_i, e_i)$  is homeomorphic to the pair  $(\bar{B}^d, S^{d-1})$ .

Then we get the next result by definition.

**Theorem 2.2**  $\pi^d(\widetilde{M}^d[G], x_0) \cong \pi_1(G, x_0), x_0 \in G$ .

Generally, we know the following result for fundamental  $d$ -groups of combinatorial manifolds ([13], [17]).

**Theorem 2.3** *Let  $\widetilde{M}(n_1, n_2, \dots, n_m)$  be a  $d$ -connected finitely combinatorial manifold for an integer  $d, 1 \leq d \leq n_1$ . If  $\forall (M_1, M_2) \in E(G^L[\widetilde{M}(n_1, n_2, \dots, n_m)])$ ,  $M_1 \cap M_2$  is simply connected, then*

- (1) for  $\forall x_0 \in G^d, M \in V(G^L[\widetilde{M}(n_1, n_2, \dots, n_m)])$  and  $x_{0M} \in M$ ,

$$\pi^d(\widetilde{M}(n_1, n_2, \dots, n_m), x_0) \cong \left( \bigoplus_{M \in V(G^d)} \pi^d(M, x_{M0}) \right) \bigoplus \pi(G^d, x_0),$$

where  $G^d = G^d[\widetilde{M}(n_1, n_2, \dots, n_m)]$  in which each edge  $(M_1, M_2)$  passing through a given point  $x_{M_1 M_2} \in M_1 \cap M_2$ ,  $\pi^d(M, x_{M0}), \pi(G^d, x_0)$  denote the fundamental  $d$ -groups of a manifold  $M$  and the graph  $G^d$ , respectively and

- (2) for  $\forall x, y \in \widetilde{M}(n_1, n_2, \dots, n_m)$ ,

$$\pi^d(\widetilde{M}(n_1, n_2, \dots, n_m), x) \cong \pi^d(\widetilde{M}(n_1, n_2, \dots, n_m), y).$$

## 2.5 Homology Group

For a subspace  $A$  of a topological space  $S$  and an inclusion mapping  $i : A \hookrightarrow S$ , it is readily verified that the induced homomorphism  $i_{\#} : C_p(A) \rightarrow C_p(S)$  is a monomorphism. Let  $C_p(S, A)$  denote the quotient group  $C_p(S)/C_p(A)$ . Similarly, we define the  *$p$ -cycle group* and  *$p$ -boundary group* of  $(S, A)$  by ([19])

$$Z_p(S, A) = \text{Ker } \partial_p = \{ u \in C_p(S, A) \mid \partial_p(u) = 0 \},$$

$$B_p(S, A) = \text{Im} \partial_{p+1} = \partial_{p+1}(C_{p+1}(S, A)),$$

for any integer  $p \geq 0$ . It follows that  $B_p(S, A) \subset Z_p(S, A)$  and the  $p$ th relative homology group  $H_p(S, A)$  is defined to be

$$H_p(S, A) = Z_p(S, A) / B_p(S, A).$$

We know the following result.

**Theorem 2.4** *Let  $\widetilde{M}$  be a combinatorial manifold,  $\widetilde{M}^d(G) \prec \widetilde{M}$  a  $d$ -dimensional graph with  $E(\widetilde{M}^d(G)) = \{e_1, e_2, \dots, e_m\}$  such that*

$$\widetilde{M} \setminus \widetilde{M}^d(G) = \bigcup_{i=2}^k \bigcup_{j=1}^{l_i} B_{i,j}.$$

*Then the inclusion  $(e_l, \dot{e}_l) \hookrightarrow (\widetilde{M}, \widetilde{M}^d(G))$  induces a monomorphism  $H_p(e_l, \dot{e}_l) \rightarrow H_p(\widetilde{M}, \widetilde{M}^d(G))$  for  $l = 1, 2, \dots, m$  and*

$$H_p(\widetilde{M}, \widetilde{M}^d(G)) \cong \begin{cases} \underbrace{\mathbf{Z} \oplus \dots \oplus \mathbf{Z}}_m, & \text{if } p = d, \\ 0, & \text{if } p \neq d. \end{cases}$$

### §3. Differentiable Combinatorial Manifolds

#### 3.1 Definition

For a given integer sequence  $1 \leq n_1 < n_2 < \dots < n_m$ , a combinatorial  $C^h$ -differential manifold  $(\widetilde{M}(n_1, \dots, n_m); \widetilde{\mathcal{A}})$  is a finitely combinatorial manifold  $\widetilde{M}(n_1, \dots, n_m)$ ,  $\widetilde{M}(n_1, \dots, n_m) = \bigcup_{i \in I} U_i$ , endowed with an atlas  $\widetilde{\mathcal{A}} = \{(U_\alpha; \varphi_\alpha) | \alpha \in I\}$  on  $\widetilde{M}(n_1, n_2, \dots, n_m)$  for an integer  $h, h \geq 1$  with conditions following hold.

- (1)  $\{U_\alpha; \alpha \in I\}$  is an open covering of  $\widetilde{M}(n_1, n_2, \dots, n_m)$ .

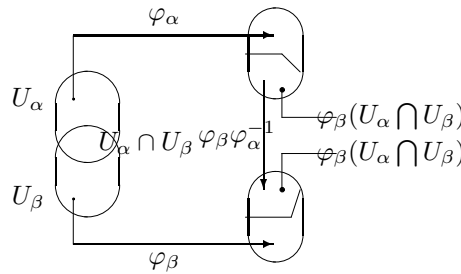

Fig.9

- (2) For  $\forall \alpha, \beta \in I$ , local charts  $(U_\alpha; \varphi_\alpha)$  and  $(U_\beta; \varphi_\beta)$  are *equivalent*, i.e.,  $U_\alpha \cap U_\beta = \emptyset$  or  $U_\alpha \cap U_\beta \neq \emptyset$  but the *overlap maps*

$$\varphi_\alpha \varphi_\beta^{-1} : \varphi_\beta(U_\alpha \cap U_\beta) \rightarrow \varphi_\beta(U_\beta) \quad \text{and} \quad \varphi_\beta \varphi_\alpha^{-1} : \varphi_\alpha(U_\alpha \cap U_\beta) \rightarrow \varphi_\alpha(U_\alpha)$$

are  $C^h$ -mappings, such as those shown in Fig.3.1.

(3)  $\tilde{\mathcal{A}}$  is maximal, i.e., if  $(U; \varphi)$  is a local chart of  $\tilde{M}(n_1, n_2, \dots, n_m)$  equivalent with one of local charts in  $\tilde{\mathcal{A}}$ , then  $(U; \varphi) \in \tilde{\mathcal{A}}$ .

Denote by  $(\tilde{M}(n_1, n_2, \dots, n_m); \tilde{\mathcal{A}})$  a combinatorial differential manifold. A finitely combinatorial manifold  $\tilde{M}(n_1, n_2, \dots, n_m)$  is said to be *smooth* if it is endowed with a  $C^\infty$ -differential structure. For the existence of combinatorial differential manifolds, we know the following result ([13],[17]).

**Theorem 3.1** *Let  $\tilde{M}(n_1, \dots, n_m)$  be a finitely combinatorial manifold and  $d, 1 \leq d \leq n_1$  an integer. If for  $\forall M \in V(G^d[\tilde{M}(n_1, \dots, n_m)])$  is  $C^h$ -differential and*

$$\forall (M_1, M_2) \in E(G^d[\tilde{M}(n_1, \dots, n_m)])$$

*there exist atlas*

$$\mathcal{A}_1 = \{(V_x; \varphi_x) | \forall x \in M_1\} \quad \mathcal{A}_2 = \{(W_y; \psi_y) | \forall y \in M_2\}$$

*such that  $\varphi_x|_{V_x \cap W_y} = \psi_y|_{V_x \cap W_y}$  for  $\forall x \in M_1, y \in M_2$ , then there is a differential structures*

$$\tilde{\mathcal{A}} = \{(U_p; [\varpi_p]) | \forall p \in \tilde{M}(n_1, \dots, n_m)\}$$

*such that  $(\tilde{M}(n_1, \dots, n_m); \tilde{\mathcal{A}})$  is a combinatorial  $C^h$ -differential manifold.*

### 3.2 Local Properties of Combinatorial Manifolds

Let  $\tilde{M}_1(n_1, \dots, n_m), \tilde{M}_2(k_1, \dots, k_l)$  be smoothly combinatorial manifolds and

$$f : \tilde{M}_1(n_1, \dots, n_m) \rightarrow \tilde{M}_2(k_1, \dots, k_l)$$

be a mapping,  $p \in \tilde{M}_1(n_1, n_2, \dots, n_m)$ . If there are local charts  $(U_p; [\varpi_p])$  of  $p$  on  $\tilde{M}_1(n_1, n_2, \dots, n_m)$  and  $(V_{f(p)}; [\omega_{f(p)}])$  of  $f(p)$  with  $f(U_p) \subset V_{f(p)}$  such that the composition mapping

$$\tilde{f} = [\omega_{f(p)}] \circ f \circ [\varpi_p]^{-1} : [\varpi_p](U_p) \rightarrow [\omega_{f(p)}](V_{f(p)})$$

is a  $C^h$ -mapping, then  $f$  is called a  $C^h$ -mapping at the point  $p$ . If  $f$  is  $C^h$  at any point  $p$  of  $\tilde{M}_1(n_1, \dots, n_m)$ , then  $f$  is called a  $C^h$ -mapping. Denote by  $\mathcal{X}_p$  all these  $C^\infty$ -functions at a point  $p \in \tilde{M}(n_1, \dots, n_m)$ .

Now let  $(\tilde{M}(n_1, \dots, n_m), \tilde{\mathcal{A}})$  be a smoothly combinatorial manifold and  $p \in \tilde{M}(n_1, \dots, n_m)$ . A tangent vector  $\bar{v}$  at  $p$  is a mapping  $\bar{v} : \mathcal{X}_p \rightarrow \mathbf{R}$  with conditions following hold.

- (1)  $\forall g, h \in \mathcal{X}_p, \forall \lambda \in \mathbf{R}, \bar{v}(h + \lambda h) = \bar{v}(g) + \lambda \bar{v}(h);$
- (2)  $\forall g, h \in \mathcal{X}_p, \bar{v}(gh) = \bar{v}(g)h(p) + g(p)\bar{v}(h).$

Let  $\gamma : (-\epsilon, \epsilon) \rightarrow \tilde{M}$  be a smooth curve on  $\tilde{M}$  and  $p = \gamma(0)$ . Then for  $\forall f \in \mathcal{X}_p$ , we usually define a mapping  $\bar{v} : \mathcal{X}_p \rightarrow \mathbf{R}$  by

$$\bar{v}(f) = \left. \frac{df(\gamma(t))}{dt} \right|_{t=0}.$$

We can easily verify such mappings  $\bar{v}$  are tangent vectors at  $p$ .

Denote all tangent vectors at  $p \in \widetilde{M}(n_1, n_2, \dots, n_m)$  by  $T_p \widetilde{M}(n_1, n_2, \dots, n_m)$  and define addition and scalar multiplication for  $\forall \bar{u}, \bar{v} \in T_p \widetilde{M}(n_1, n_2, \dots, n_m)$ ,  $\lambda \in \mathbf{R}$  and  $f \in \mathcal{X}_p$  by

$$(\bar{u} + \bar{v})(f) = \bar{u}(f) + \bar{v}(f), \quad (\lambda \bar{u})(f) = \lambda \cdot \bar{u}(f).$$

Then it can be shown immediately that  $T_p \widetilde{M}(n_1, n_2, \dots, n_m)$  is a vector space under these two operations. Let

$$\mathcal{X}(\widetilde{M}(n_1, n_2, \dots, n_m)) = \bigcup_{p \in \widetilde{M}} T_p \widetilde{M}(n_1, n_2, \dots, n_m).$$

A *vector field* on  $\widetilde{M}(n_1, n_2, \dots, n_m)$  is a mapping  $X : \widetilde{M} \rightarrow \mathcal{X}(\widetilde{M}(n_1, n_2, \dots, n_m))$ , i.e., chosen a vector at each point  $p \in \widetilde{M}(n_1, n_2, \dots, n_m)$ . Then the dimension and basis of the tangent space  $T_p \widetilde{M}(n_1, n_2, \dots, n_m)$  are determined in the next result.

**Theorem 3.2** For any point  $p \in \widetilde{M}(n_1, n_2, \dots, n_m)$  with a local chart  $(U_p; [\varphi_p])$ , the dimension of  $T_p \widetilde{M}(n_1, n_2, \dots, n_m)$  is

$$\dim T_p \widetilde{M}(n_1, n_2, \dots, n_m) = \widehat{s}(p) + \sum_{i=1}^{s(p)} (n_i - \widehat{s}(p))$$

with a basis matrix

$$\left[ \frac{\partial}{\partial \bar{x}} \right]_{s(p) \times n_{s(p)}} = \begin{bmatrix} \frac{1}{s(p)} \frac{\partial}{\partial x^{11}} & \cdots & \frac{1}{s(p)} \frac{\partial}{\partial x^{1s(p)}} & \frac{\partial}{\partial x^{1(\widehat{s}(p)+1)}} & \cdots & \frac{\partial}{\partial x^{1n_1}} & \cdots & 0 \\ \frac{1}{s(p)} \frac{\partial}{\partial x^{21}} & \cdots & \frac{1}{s(p)} \frac{\partial}{\partial x^{2s(p)}} & \frac{\partial}{\partial x^{2(\widehat{s}(p)+1)}} & \cdots & \frac{\partial}{\partial x^{2n_2}} & \cdots & 0 \\ \cdots & \cdots & \cdots & \cdots & \cdots & \cdots & \cdots & \cdots \\ \frac{1}{s(p)} \frac{\partial}{\partial x^{s(p)1}} & \cdots & \frac{1}{s(p)} \frac{\partial}{\partial x^{s(p)s(p)}} & \frac{\partial}{\partial x^{s(p)(\widehat{s}(p)+1)}} & \cdots & \cdots & \frac{\partial}{\partial x^{s(p)(n_{s(p)}-1)}} & \frac{\partial}{\partial x^{s(p)n_{s(p)}}} \end{bmatrix}$$

where  $x^{il} = x^{jl}$  for  $1 \leq i, j \leq s(p)$ ,  $1 \leq l \leq \widehat{s}(p)$ , namely there is a smoothly functional matrix  $[v_{ij}]_{s(p) \times n_{s(p)}}$  such that for any tangent vector  $\bar{v}$  at a point  $p$  of  $\widetilde{M}(n_1, n_2, \dots, n_m)$ ,

$$\bar{v} = \left\langle [v_{ij}]_{s(p) \times n_{s(p)}}, \left[ \frac{\partial}{\partial \bar{x}} \right]_{s(p) \times n_{s(p)}} \right\rangle,$$

where  $\langle [a_{ij}]_{k \times l}, [b_{ts}]_{k \times l} \rangle = \sum_{i=1}^k \sum_{j=1}^l a_{ij} b_{ij}$ , the inner product on matrixes.

For  $\forall p \in (\widetilde{M}(n_1, n_2, \dots, n_m); \widetilde{\mathcal{A}})$ , the dual space  $T_p^* \widetilde{M}(n_1, n_2, \dots, n_m)$  is called a *co-tangent vector space* at  $p$ . Let  $f \in \mathcal{X}_p$ ,  $d \in T_p^* \widetilde{M}(n_1, n_2, \dots, n_m)$  and  $\bar{v} \in T_p \widetilde{M}(n_1, n_2, \dots, n_m)$ . Then the action of  $d$  on  $f$ , called a *differential operator*  $d : \mathcal{X}_p \rightarrow \mathbf{R}$ , is defined by

$$df = \bar{v}(f).$$

We know the following result.



**Theorem 3.3** For  $\forall p \in (\widetilde{M}(n_1, n_2, \dots, n_m); \widetilde{A})$  with a local chart  $(U_p; [\varphi_p])$ , the dimension of  $T_p^* \widetilde{M}(n_1, n_2, \dots, n_m)$  is  $\dim T_p^* \widetilde{M}(n_1, n_2, \dots, n_m) = \dim T_p \widetilde{M}(n_1, n_2, \dots, n_m)$  with a basis matrix  $[d\bar{x}]_{s(p) \times n_{s(p)}} =$

$$\begin{bmatrix} \frac{dx^{11}}{s(p)} & \dots & \frac{dx^{1\widehat{s}(p)}}{s(p)} & dx^{1(\widehat{s}(p)+1)} & \dots & dx^{1n_1} & \dots & 0 \\ \frac{dx^{21}}{s(p)} & \dots & \frac{dx^{2\widehat{s}(p)}}{s(p)} & dx^{2(\widehat{s}(p)+1)} & \dots & dx^{2n_2} & \dots & 0 \\ \dots & \dots & \dots & \dots & \dots & \dots & \dots & \dots \\ \frac{dx^{s(p)1}}{s(p)} & \dots & \frac{dx^{s(p)\widehat{s}(p)}}{s(p)} & dx^{s(p)(\widehat{s}(p)+1)} & \dots & \dots & dx^{s(p)n_{s(p)}-1} & dx^{s(p)n_{s(p)}} \end{bmatrix}$$

where  $x^{il} = x^{jl}$  for  $1 \leq i, j \leq s(p), 1 \leq l \leq \widehat{s}(p)$ , namely for any co-tangent vector  $d$  at a point  $p$  of  $\widetilde{M}(n_1, n_2, \dots, n_m)$ , there is a smoothly functional matrix  $[u_{ij}]_{s(p) \times s(p)}$  such that,

$$d = \left\langle [u_{ij}]_{s(p) \times s(p)}, [d\bar{x}]_{s(p) \times n_{s(p)}} \right\rangle.$$

### 3.3 Tensor Field

Let  $\widetilde{M}(n_1, n_2, \dots, n_m)$  be a smoothly combinatorial manifold and  $p \in \widetilde{M}(n_1, n_2, \dots, n_m)$ . A tensor of type  $(r, s)$  at the point  $p$  on  $\widetilde{M}(n_1, n_2, \dots, n_m)$  is an  $(r + s)$ -multilinear function  $\tau$ ,

$$\tau : \underbrace{T_p^* \widetilde{M} \times \dots \times T_p^* \widetilde{M}}_r \times \underbrace{T_p \widetilde{M} \times \dots \times T_p \widetilde{M}}_s \rightarrow \mathbf{R},$$

where  $T_p \widetilde{M} = T_p \widetilde{M}(n_1, n_2, \dots, n_m)$  and  $T_p^* \widetilde{M} = T_p^* \widetilde{M}(n_1, n_2, \dots, n_m)$ . Denoted by  $T_s^r(p, \widetilde{M})$  all tensors of type  $(r, s)$  at a point  $p$  of  $\widetilde{M}(n_1, n_2, \dots, n_m)$ . We know its structure as follows.

**Theorem 3.4** Let  $\widetilde{M}(n_1, \dots, n_m)$  be a smoothly combinatorial manifold and  $p \in \widetilde{M}(n_1, \dots, n_m)$ . Then

$$T_s^r(p, \widetilde{M}) = \underbrace{T_p \widetilde{M} \otimes \dots \otimes T_p \widetilde{M}}_r \otimes \underbrace{T_p^* \widetilde{M} \otimes \dots \otimes T_p^* \widetilde{M}}_s,$$

where  $T_p \widetilde{M} = T_p \widetilde{M}(n_1, \dots, n_m)$  and  $T_p^* \widetilde{M} = T_p^* \widetilde{M}(n_1, \dots, n_m)$ , particularly,

$$\dim T_s^r(p, \widetilde{M}) = (\widehat{s}(p) + \sum_{i=1}^{s(p)} (n_i - \widehat{s}(p)))^{r+s}.$$

### 3.4 Curvature Tensor

A connection on tensors of a smoothly combinatorial manifold  $\widetilde{M}$  is a mapping  $\widetilde{D} : \mathcal{X}(\widetilde{M}) \times T_s^r \widetilde{M} \rightarrow T_s^r \widetilde{M}$  with  $\widetilde{D}_X \tau = \widetilde{D}(X, \tau)$  such that for  $\forall X, Y \in \mathcal{X} \widetilde{M}$ ,  $\tau, \pi \in T_s^r(\widetilde{M}), \lambda \in \mathbf{R}$  and  $f \in C^\infty(\widetilde{M})$ ,

- (1)  $\widetilde{D}_{X+fY} \tau = \widetilde{D}_X \tau + f \widetilde{D}_Y \tau$ ; and  $\widetilde{D}_X(\tau + \lambda \pi) = \widetilde{D}_X \tau + \lambda \widetilde{D}_X \pi$ ;
- (2)  $\widetilde{D}_X(\tau \otimes \pi) = \widetilde{D}_X \tau \otimes \pi + \sigma \otimes \widetilde{D}_X \pi$ ;
- (3) for any contraction  $C$  on  $T_s^r(\widetilde{M})$ ,

$$\widetilde{D}_X(C(\tau)) = C(\widetilde{D}_X \tau).$$

A *combinatorial connection space* is a 2-tuple  $(\widetilde{M}, \widetilde{D})$  consisting of a smoothly combinatorial manifold  $\widetilde{M}$  with a connection  $\widetilde{D}$  on its tensors. Let  $(\widetilde{M}, \widetilde{D})$  be a combinatorial connection space. For  $\forall X, Y \in \mathcal{X}(\widetilde{M})$ , a *combinatorial curvature operator*  $\widetilde{\mathcal{R}}(X, Y) : \mathcal{X}(\widetilde{M}) \rightarrow \mathcal{X}(\widetilde{M})$  is defined by

$$\widetilde{\mathcal{R}}(X, Y)Z = \widetilde{D}_X \widetilde{D}_Y Z - \widetilde{D}_Y \widetilde{D}_X Z - \widetilde{D}_{[X, Y]}Z$$

for  $\forall Z \in \mathcal{X}(\widetilde{M})$ .

Let  $\widetilde{M}$  be a smoothly combinatorial manifold and  $g \in A^2(\widetilde{M}) = \bigcup_{p \in \widetilde{M}} T_2^0(p, \widetilde{M})$ . If  $g$  is symmetrical and positive, then  $\widetilde{M}$  is called a *combinatorial Riemannian manifold*, denoted by  $(\widetilde{M}, g)$ . In this case, if there is a connection  $\widetilde{D}$  on  $(\widetilde{M}, g)$  with equality following hold

$$Z(g(X, Y)) = g(\widetilde{D}_Z, Y) + g(X, \widetilde{D}_Z Y)$$

then  $\widetilde{M}$  is called a *combinatorial Riemannian geometry*, denoted by  $(\widetilde{M}, g, \widetilde{D})$ . In this case, calculation shows that ([14])

$$\widetilde{R} = \widetilde{R}_{(\sigma\varsigma)(\eta\theta)(\mu\nu)(\kappa\lambda)} dx^{\sigma\varsigma} \otimes dx^{\eta\theta} \otimes dx^{\mu\nu} \otimes dx^{\kappa\lambda}$$

with

$$\begin{aligned} \widetilde{R}_{(\sigma\varsigma)(\eta\theta)(\mu\nu)(\kappa\lambda)} &= \frac{1}{2} \left( \frac{\partial^2 g_{(\mu\nu)(\sigma\varsigma)}}{\partial x^{\kappa\lambda} \partial x^{\eta\theta}} + \frac{\partial^2 g_{(\kappa\lambda)(\eta\theta)}}{\partial x^{\mu\nu} \partial x^{\sigma\varsigma}} - \frac{\partial^2 g_{(\mu\nu)(\eta\theta)}}{\partial x^{\kappa\lambda} \partial x^{\sigma\varsigma}} - \frac{\partial^2 g_{(\kappa\lambda)(\sigma\varsigma)}}{\partial x^{\mu\nu} \partial x^{\eta\theta}} \right) \\ &+ \Gamma_{(\mu\nu)(\sigma\varsigma)}^{\vartheta\iota} \Gamma_{(\kappa\lambda)(\eta\theta)}^{\xi\omicron} g_{(\xi\omicron)(\vartheta\iota)} - \Gamma_{(\mu\nu)(\eta\theta)}^{\xi\omicron} \Gamma_{(\kappa\lambda)(\sigma\varsigma)}^{\vartheta\iota} g_{(\xi\omicron)(\vartheta\iota)}, \end{aligned}$$

where  $g_{(\mu\nu)(\kappa\lambda)} = g(\frac{\partial}{\partial x^{\mu\nu}}, \frac{\partial}{\partial x^{\kappa\lambda}})$ .

#### §4. Principal Fiber Bundles

In classical differential geometry, a principal fiber bundle ([3]) is an application of covering space to smoothly manifolds. Topologically, a covering space ([18])  $S'$  of  $S$  consisting of a space  $S'$  with a continuous mapping  $\pi : S' \rightarrow S$  such that each point  $x \in S$  has an arcwise connected neighborhood  $U_x$  and each arcwise connected component of  $\pi^{-1}(U_x)$  is mapped homeomorphically onto  $U_x$  by  $\pi$ , such as those shown in Fig.10.

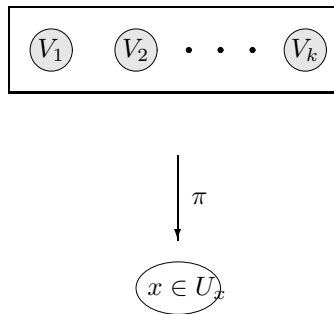

Fig.10

where  $V_i = \pi^{-1}(U_x)$  for integers  $1 \leq i \leq k$ .

A *principal fiber bundle* ([3]) consists of a manifold  $P$  action by a Lie group  $\mathcal{G}$ , which is a manifold with group operation  $\mathcal{G} \times \mathcal{G} \rightarrow \mathcal{G}$  given by  $(g, h) \rightarrow g \circ h$  being  $C^\infty$  mapping, a projection  $\pi : P \rightarrow M$ , a base pseudo-manifold  $M$ , denoted by  $(P, M, \mathcal{G})$ , seeing Fig.4.2 such that conditions (1), (2) and (3) following hold.

(1) there is a right freely action of  $\mathcal{G}$  on  $P$ , i.e., for  $\forall g \in \mathcal{G}$ , there is a diffeomorphism  $R_g : P \rightarrow P$  with  $R_g(p) = pg$  for  $\forall p \in P$  such that  $p(g_1g_2) = (pg_1)g_2$  for  $\forall p \in P, \forall g_1, g_2 \in \mathcal{G}$  and  $pe = p$  for some  $p \in P, e \in \mathcal{G}$  if and only if  $e$  is the identity element of  $\mathcal{G}$ .

(2) the map  $\pi : P \rightarrow M$  is onto with  $\pi^{-1}(\pi(p)) = \{pg | g \in \mathcal{G}\}$ .

(3) for  $\forall x \in M$  there is an open set  $U$  with  $x \in U$  and a diffeomorphism  $T_U : \pi^{-1}(U) \rightarrow U \times \mathcal{G}$  of the form  $T_U(p) = (\pi(p), s_U(p))$ , where  $s_U : \pi^{-1}(U) \rightarrow \mathcal{G}$  has the property  $s_U(pg) = s_U(p)g$  for  $\forall g \in \mathcal{G}, p \in \pi^{-1}(U)$ .

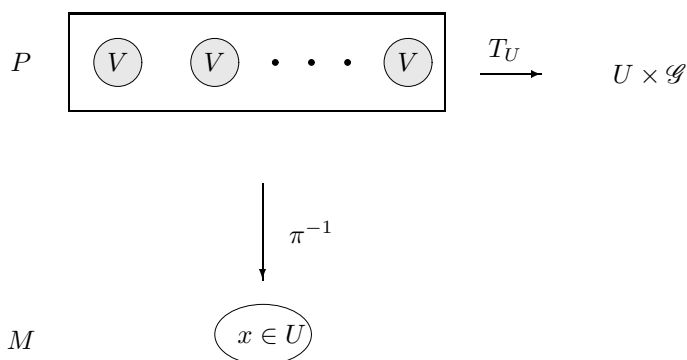

Fig.11

where  $V = \pi^{-1}(U)$ . Now can we establish principal fiber bundles on smoothly combinatorial manifolds? This question can be formally presented as follows:

**Question** For a family of  $k$  principal fiber bundles  $P_1(M_1, \mathcal{G}_1), P_2(M_2, \mathcal{G}_2), \dots, P_k(M_k, \mathcal{G}_k)$  over manifolds  $M_1, M_2, \dots, M_k$ , how can we construct principal fiber bundles on a smoothly combinatorial manifold consisting of  $M_1, M_2, \dots, M_k$  underlying a connected graph  $G$ ?

The answer is YES! For this object, we need some techniques in combinatorics.

### 4.1 Voltage Graph with Its Lifting

Let  $G$  be a connected graph and  $(\Gamma; \circ)$  a group. For each edge  $e \in E(G), e = uv$ , an *orientation* on  $e$  is an orientation on  $e$  from  $u$  to  $v$ , denoted by  $e = (u, v)$ , called *plus orientation* and its *minus orientation*, from  $v$  to  $u$ , denoted by  $e^{-1} = (v, u)$ . For a given graph  $G$  with plus and minus orientation on its edges, a *voltage assignment* on  $G$  is a mapping  $\alpha$  from the plus-edges of  $G$  into a group  $\Gamma$  satisfying  $\alpha(e^{-1}) = \alpha^{-1}(e), e \in E(G)$ . These elements  $\alpha(e), e \in E(G)$  are called voltages, and  $(G, \alpha)$  a *voltage graph* over the group  $(\Gamma; \circ)$ .

For a voltage graph  $(G, \alpha)$ , its lifting (See [6], [9] for details)  $G^\alpha = (V(G^\alpha), E(G^\alpha); I(G^\alpha))$  is defined by

$$V(G^\alpha) = V(G) \times \Gamma, \quad (u, a) \in V(G) \times \Gamma \text{ abbreviated to } u_a;$$

$$E(G^\alpha) = \{(u_a, v_{a\circ b}) \mid e^+ = (u, v) \in E(G), \alpha(e^+) = b\}.$$

For example, let  $G = K_3$  and  $\Gamma = Z_2$ . Then the voltage graph  $(K_3, \alpha)$  with  $\alpha : K_3 \rightarrow Z_2$  and its lifting are shown in Fig.12.

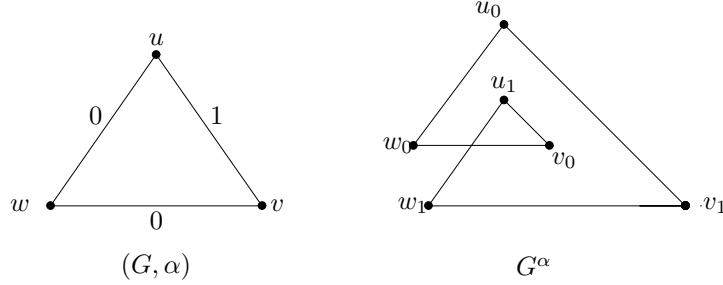

**Fig.12**

Similarly, let  $G^L$  be a connected vertex-edge labeled graph with  $\theta_L : V(G) \cup E(G) \rightarrow L$  of a label set and  $\Gamma$  a finite group. A *voltage labeled graph* on a vertex-edge labeled graph  $G^L$  is a 2-tuple  $(G^L; \alpha)$  with a voltage assignments  $\alpha : E(G^L) \rightarrow \Gamma$  such that

$$\alpha(u, v) = \alpha^{-1}(v, u), \quad \forall (u, v) \in E(G^L).$$

Similar to voltage graphs, the importance of voltage labeled graphs lies in their *labeled lifting*  $G^{L\alpha}$  defined by

$$V(G^{L\alpha}) = V(G^L) \times \Gamma, \quad (u, g) \in V(G^L) \times \Gamma \text{ abbreviated to } u_g;$$

$$E(G^{L\alpha}) = \{ (u_g, v_{g\circ h}) \mid \text{for } \forall (u, v) \in E(G^L) \text{ with } \alpha(u, v) = h \}$$

with labels  $\Theta_L : G^{L\alpha} \rightarrow L$  following:

$$\Theta_L(u_g) = \theta_L(u), \quad \text{and} \quad \Theta_L(u_g, v_{g\circ h}) = \theta_L(u, v)$$

for  $u, v \in V(G^L)$ ,  $(u, v) \in E(G^L)$  with  $\alpha(u, v) = h$  and  $g, h \in \Gamma$ .

For a voltage labeled graph  $(G^L, \alpha)$  with its lifting  $G^{L\alpha}$ , a *natural projection*  $\pi : G^{L\alpha} \rightarrow G^L$  is defined by  $\pi(u_g) = u$  and  $\pi(u_g, v_{g\circ h}) = (u, v)$  for  $\forall u, v \in V(G^L)$  and  $(u, v) \in E(G^L)$  with  $\alpha(u, v) = h$ . Whence,  $(G^{L\alpha}, \pi)$  is a covering space of the labeled graph  $G^L$ . In this covering, we can find

$$\pi^{-1}(u) = \{ u_g \mid \forall g \in \Gamma \}$$

for a vertex  $u \in V(G^L)$  and

$$\pi^{-1}(u, v) = \{ (u_g, v_{g\circ h}) \mid \forall g \in \Gamma \}$$

for an edge  $(u, v) \in E(G^L)$  with  $\alpha(u, v) = h$ . Such sets  $\pi^{-1}(u)$ ,  $\pi^{-1}(u, v)$  are called *fibres* over the vertex  $u \in V(G^L)$  or edge  $(u, v) \in E(G^L)$ , denoted by  $\text{fib}_u$  or  $\text{fib}_{(u,v)}$ , respectively. A voltage labeled graph with its labeled lifting are shown in Fig.13, in where,  $G^L = C_3^L$  and  $\Gamma = Z_2$ .

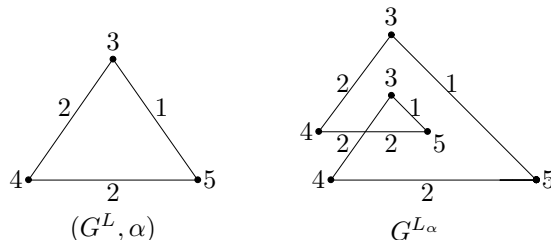

Fig.13

A mapping  $g : G^L \rightarrow G^L$  is *acting on a labeled graph*  $G^L$  with a labeling  $\theta_L : G^L \rightarrow L$  if  $g\theta_L(x) = \theta_L g(x)$  for  $\forall x \in V(G^L) \cup E(G^L)$ , and a group  $\Gamma$  is acting on a labeled graph  $G^L$  if each  $g \in \Gamma$  is acting on  $G^L$ . Clearly, if  $\Gamma$  is acting on a labeled graph  $G^L$ , then  $\Gamma \leq \text{Aut}G$ .

Now let  $A$  be a group of automorphisms of  $G^L$ . A voltage labeled graph  $(G^L, \alpha)$  is called *locally A-invariant* at a vertex  $u \in V(G^L)$  if for  $\forall f \in A$  and  $W \in \pi_1(G^L, u)$ , we have

$$\alpha(W) = \text{identity} \Rightarrow \alpha(f(W)) = \text{identity}$$

and *locally f-invariant* for an automorphism  $f \in \text{Aut}G^L$  if it is locally invariant with respect to the group  $\langle f \rangle$  in  $\text{Aut}G^L$ . Then we know a criterion for lifting automorphisms of voltage labeled graphs.

**Theorem 4.1** *Let  $(G^L, \alpha)$  be a voltage labeled graph with  $\alpha : E(G^L) \rightarrow \Gamma$  and  $f \in \text{Aut}G^L$ . Then  $f$  lifts to an automorphism of  $G^{L\alpha}$  if and only if  $(G^L, \alpha)$  is locally  $f$ -invariant.*

### 4.2 Combinatorial Principal Fiber Bundles

For construction principal fiber bundles on smoothly combinatorial manifolds, we need to introduce the conception of Lie multi-group. A *Lie multi-group*  $\mathcal{L}_G$  is a smoothly combinatorial manifold  $\widetilde{M}$  endowed with a multi-group  $(\widetilde{\mathcal{A}}(\mathcal{L}_G); \mathcal{O}(\mathcal{L}_G))$ , where  $\widetilde{\mathcal{A}}(\mathcal{L}_G) = \bigcup_{i=1}^m \mathcal{H}_i$  and

$$\mathcal{O}(\mathcal{L}_G) = \bigcup_{i=1}^m \{\circ_i\} \text{ such that}$$

(i)  $(\mathcal{H}_i; \circ_i)$  is a group for each integer  $i$ ,  $1 \leq i \leq m$ ;

(ii)  $G^L[\widetilde{M}] = G$ ;

(iii) the mapping  $(a, b) \rightarrow a \circ_i b^{-1}$  is  $C^\infty$ -differentiable for any integer  $i$ ,  $1 \leq i \leq m$  and  $\forall a, b \in \mathcal{H}_i$ .

Notice that if  $m = 1$ , then a Lie multi-group  $\mathcal{L}_G$  is nothing but just the Lie group ([24]) in classical differential geometry.

Now let  $\widetilde{P}$ ,  $\widetilde{M}$  be a differentially combinatorial manifolds and  $\mathcal{L}_G$  a Lie multi-group

$(\widetilde{\mathcal{A}}(\mathcal{L}_G); \mathcal{O}(\mathcal{L}_G))$  with

$$\widetilde{P} = \bigcup_{i=1}^m P_i, \quad \widetilde{M} = \bigcup_{i=1}^s M_i, \quad \widetilde{\mathcal{A}}(\mathcal{L}_G) = \bigcup_{i=1}^m \mathcal{H}_{\circ_i}, \quad \mathcal{O}(\mathcal{L}_G) = \bigcup_{i=1}^m \{\circ_i\}.$$

Then a *differentiable principal fiber bundle over  $\widetilde{M}$  with group  $\mathcal{L}_G$*  consists of a differentiable combinatorial manifold  $\widetilde{P}$ , an action of  $\mathcal{L}_G$  on  $\widetilde{P}$ , denoted by  $\widetilde{P}(\widetilde{M}, \mathcal{L}_G)$  satisfying following conditions PFB1-PFB3:

**PFB1.** For any integer  $i$ ,  $1 \leq i \leq m$ ,  $\mathcal{H}_{\circ_i}$  acts differentiably on  $P_i$  to the right without fixed point, i.e.,

$$(x, g) \in P_i \times \mathcal{H}_{\circ_i} \rightarrow x \circ_i g \in P_i \text{ and } x \circ_i g = x \text{ implies that } g = 1_{\circ_i};$$

**PFB2.** For any integer  $i$ ,  $1 \leq i \leq m$ ,  $M_{\circ_i}$  is the quotient space of a covering manifold  $P \in \Pi^{-1}(M_{\circ_i})$  by the equivalence relation  $R$  induced by  $\mathcal{H}_{\circ_i}$ :

$$R_i = \{(x, y) \in P_{\circ_i} \times P_{\circ_i} | \exists g \in \mathcal{H}_{\circ_i} \Rightarrow x \circ_i g = y\},$$

written by  $M_{\circ_i} = P_{\circ_i} / \mathcal{H}_{\circ_i}$ , i.e., an orbit space of  $P_{\circ_i}$  under the action of  $\mathcal{H}_{\circ_i}$ . These is a canonical projection  $\Pi : \widetilde{P} \rightarrow \widetilde{M}$  such that  $\Pi_i = \Pi|_{P_{\circ_i}} : P_{\circ_i} \rightarrow M_{\circ_i}$  is differentiable and each fiber  $\Pi_i^{-1}(x) = \{p \circ_i g | g \in \mathcal{H}_{\circ_i}, \Pi_i(p) = x\}$  is a closed submanifold of  $P_{\circ_i}$  and coincides with an equivalence class of  $R_i$ ;

**PFB3.** For any integer  $i$ ,  $1 \leq i \leq m$ ,  $P \in \Pi^{-1}(M_{\circ_i})$  is locally trivial over  $M_{\circ_i}$ , i.e., any  $x \in M_{\circ_i}$  has a neighborhood  $U_x$  and a diffeomorphism  $T : \Pi^{-1}(U_x) \rightarrow U_x \times \mathcal{L}_G$  with

$$T|_{\Pi^{-1}(U_x)} = T_i^x : \Pi_i^{-1}(U_x) \rightarrow U_x \times \mathcal{H}_{\circ_i}; \quad x \rightarrow T_i^x(x) = (\Pi_i(x), \epsilon(x)),$$

called a local trivialization (abbreviated to LT) such that  $\epsilon(x \circ_i g) = \epsilon(x) \circ_i g$  for  $\forall g \in \mathcal{H}_{\circ_i}$ ,  $\epsilon(x) \in \mathcal{H}_{\circ_i}$ .

Certainly, if  $m = 1$ , then  $\widetilde{P}(\widetilde{M}, \mathcal{L}_G) = P(M, \mathcal{H})$  is just the common principal fiber bundle over a manifold  $M$ .

### 4.3 Construction by Voltage Assignment

Now we show how to construct principal fiber bundles over a combinatorial manifold  $\widetilde{M}$ .

**Construction 4.1** For a family of principal fiber bundles over manifolds  $M_1, M_2, \dots, M_l$ , such as those shown in Fig.14, where  $\mathcal{H}_{\circ_i}$  is a Lie group acting on  $P_{M_i}$  for  $1 \leq i \leq l$  satisfying conditions PFB1-PFB3, let  $\widetilde{M}$  be a differentiable combinatorial manifold consisting of  $M_i$ ,  $1 \leq i \leq l$  and  $(G^L[\widetilde{M}], \alpha)$  a voltage graph with a voltage assignment  $\alpha : G^L[\widetilde{M}] \rightarrow \mathfrak{G}$  over a finite group  $\mathfrak{G}$ ,

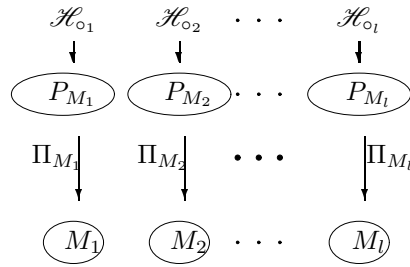

Fig.14

which naturally induced a projection  $\pi : G^L[\tilde{P}] \rightarrow G^L[\tilde{M}]$ . For  $\forall M \in V(G^L[\tilde{M}])$ , if  $\pi(P_M) = M$ , place  $P_M$  on each lifting vertex  $M^{L\alpha}$  in the fiber  $\pi^{-1}(M)$  of  $G^{L\alpha}[\tilde{M}]$ , such as those shown in Fig.15.

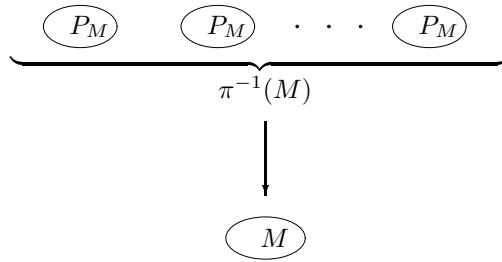

Fig.15

Let  $\Pi = \pi \Pi_M \pi^{-1}$  for  $\forall M \in V(G^L[\tilde{M}])$ . Then  $\tilde{P} = \bigcup_{M \in V(G^L[\tilde{M}])} P_M$  is a smoothly combinatorial manifold and  $\mathcal{L}_G = \bigcup_{M \in V(G^L[\tilde{M}])} \mathcal{H}_M$  a Lie multigroup by definition. Such a constructed combinatorial fiber bundle is denoted by  $\tilde{P}^{L\alpha}(\tilde{M}, \mathcal{L}_G)$ .

For example, let  $\mathfrak{G} = Z_2$  and  $G^L[\tilde{M}] = C_3$ . A voltage assignment  $\alpha : G^L[\tilde{M}] \rightarrow Z_2$  and its induced combinatorial fiber bundle are shown in Fig.16.

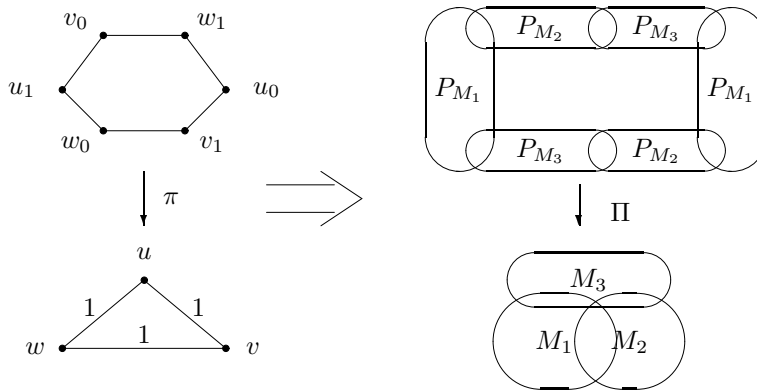

Fig.16

Then we know the existence result following.

**Theorem 4.2** *A combinatorial fiber bundle  $\tilde{P}^\alpha(\tilde{M}, \mathcal{L}_G)$  is a principal fiber bundle if and only if for  $\forall(M', M'') \in E(G^L[\tilde{M}])$  and  $(P_{M'}, P_{M''}) = (M', M'')^{L_\alpha} \in E(G^L[\tilde{P}])$ ,  $\Pi_{M'}|_{P_{M'} \cap P_{M''}} = \Pi_{M''}|_{P_{M'} \cap P_{M''}}$ .*

We assume  $\tilde{P}^\alpha(\tilde{M}, \mathcal{L}_G)$  satisfying conditions in Theorem 4.2, i.e., it is indeed a principal fiber bundle over  $\tilde{M}$ . An *automorphism* of  $\tilde{P}^\alpha(\tilde{M}, \mathcal{L}_G)$  is a diffeomorphism  $\omega : \tilde{P} \rightarrow \tilde{P}$  such that  $\omega(p \circ_i g) = \omega(p) \circ_i g$  for  $g \in \mathcal{H}_{\circ_i}$  and

$$p \in \bigcup_{P \in \pi^{-1}(M_i)} P, \quad \text{where } 1 \leq i \leq l.$$

**Theorem 4.3** *Let  $\tilde{P}^\alpha(\tilde{M}, \mathcal{L}_G)$  be a principal fiber bundle. Then*

$$\text{Aut}\tilde{P}^\alpha(\tilde{M}, \mathcal{L}_G) \geq \langle \mathfrak{L} \rangle,$$

where  $\mathfrak{L} = \{ \hat{h}\omega_i \mid \hat{h} : P_{M_i} \rightarrow P_{M_i} \text{ is } 1_{P_{M_i}} \text{ determined by } h((M_i)_g) = (M_i)_{g \circ_i h} \text{ for } h \in \mathfrak{G} \text{ and } g_i \in \text{Aut}P_{M_i}(M_i, \mathcal{H}_{\circ_i}), 1 \leq i \leq l \}$ .

A principal fiber bundle  $\tilde{P}(\tilde{M}, \mathcal{L}_G)$  is called to be *normal* if for  $\forall u, v \in \tilde{P}$ , there exists an  $\omega \in \text{Aut}\tilde{P}(\tilde{M}, \mathcal{L}_G)$  such that  $\omega(u) = v$ . We get the necessary and sufficient conditions of normally principal fiber bundles  $\tilde{P}^\alpha(\tilde{M}, \mathcal{L}_G)$  following.

**Theorem 4.4**  *$\tilde{P}^\alpha(\tilde{M}, \mathcal{L}_G)$  is normal if and only if  $P_{M_i}(M_i, \mathcal{H}_{\circ_i})$  is normal,  $(\mathcal{H}_{\circ_i}; \circ_i) = (\mathcal{H}; \circ)$  for  $1 \leq i \leq l$  and  $G^{L_\alpha}[\tilde{M}]$  is transitive by diffeomorphic automorphisms in  $\text{Aut}G^{L_\alpha}[\tilde{M}]$ .*

#### 4.4 Connection on Principal Fiber Bundles over Combinatorial Manifolds

A *local connection* on a principal fiber bundle  $\tilde{P}^\alpha(\tilde{M}, \mathcal{L}_G)$  is a linear mapping  ${}^i\Gamma_u : T_x(\tilde{M}) \rightarrow T_u(\tilde{P})$  for an integer  $i$ ,  $1 \leq i \leq l$  and  $u \in \Pi_i^{-1}(x) = {}^iF_x$ ,  $x \in M_i$ , enjoys with properties following:

- (i)  $(d\Pi_i){}^i\Gamma_u = \text{identity mapping on } T_x(\tilde{M});$
- (ii)  ${}^i\Gamma_{R_g \circ_i u} = d{}^iR_g \circ_i {}^i\Gamma_u$ , where  ${}^iR_g$  is the right translation on  $P_{M_i}$ ;
- (iii) the mapping  $u \rightarrow {}^i\Gamma_u$  is  $C^\infty$ .

Similarly, a *global connection* on a principal fiber bundle  $\tilde{P}^\alpha(\tilde{M}, \mathcal{L}_G)$  is a linear mapping  $\Gamma_u : T_x(\tilde{M}) \rightarrow T_u(\tilde{P})$  for a  $u \in \Pi^{-1}(x) = F_x$ ,  $x \in \tilde{M}$  with conditions following hold:

- (i)  $(d\Pi)\Gamma_u = \text{identity mapping on } T_x(\tilde{M});$
- (ii)  $\Gamma_{R_g \circ u} = dR_g \circ \Gamma_u$  for  $\forall g \in \mathcal{L}_G$ ,  $\forall \circ \in \mathcal{O}(\mathcal{L}_G)$ , where  $R_g$  is the right translation on  $\tilde{P}$ ;
- (iii) the mapping  $u \rightarrow \Gamma_u$  is  $C^\infty$ .

Local or global connections on combinatorial principal fiber bundles are characterized by results following.

**Theorem 4.5** *For an integer  $i$ ,  $1 \leq i \leq l$ , a local connection  ${}^i\Gamma$  in  $\tilde{P}$  is an assignment  ${}^iH : u \rightarrow {}^iH_u \subset T_u(\tilde{P})$ , of a subspace  ${}^iH_u$  of  $T_u(\tilde{P})$  to each  $u \in {}^iF_x$  with*

- (i)  $T_u(\tilde{P}) = {}^iH_u \oplus {}^iV_u$ ,  $u \in {}^iF_x$ ;



- (ii)  $(d {}^i R_g) {}^i H_u = {}^i H_{u \circ_i g}$  for  $\forall u \in {}^i F_x$  and  $\forall g \in \mathcal{H}_{\circ_i}$ ;
- (iii)  ${}^i H$  is a  $C^\infty$ -distribution on  $\tilde{P}$ .

**Theorem 4.6** A global connection  $\Gamma$  in  $\tilde{P}$  is an assignment  $H : u \rightarrow H_u \subset T_u(\tilde{P})$ , of a subspace  $H_u$  of  $T_u(\tilde{P})$  to each  $u \in F_x$  with

- (i)  $T_u(\tilde{P}) = H_u \oplus V_u$ ,  $u \in F_x$ ;
- (ii)  $(dR_g)H_u = H_{u \circ g}$  for  $\forall u \in F_x$ ,  $\forall g \in \mathcal{L}_G$  and  $\circ \in \mathcal{O}(\mathcal{L}_G)$ ;
- (iii)  $H$  is a  $C^\infty$ -distribution on  $\tilde{P}$ .

**Theorem 4.7** Let  ${}^i \Gamma$  be a local connections on  $\tilde{P}^\alpha(\tilde{M}, \mathcal{L}_G)$  for  $1 \leq i \leq l$ . Then a global connection on  $\tilde{P}^\alpha(\tilde{M}, \mathcal{L}_G)$  exists if and only if  $(\mathcal{H}_{\circ_i}; \circ_i) = (\mathcal{H}; \circ)$ , i.e.,  $\mathcal{L}_G$  is a group and  ${}^i \Gamma|_{M_i \cap M_j} = {}^j \Gamma|_{M_i \cap M_j}$  for  $(M_i, M_j) \in E(G^L[\tilde{M}])$ ,  $1 \leq i, j \leq l$ .

A curvature form of a local or global connection is a  $\mathfrak{Y}(\mathcal{H}_{\circ_i}, \circ_i)$  or  $\mathfrak{Y}(\mathcal{L}_G)$ -valued 2-form

$${}^i \Omega = (d {}^i \omega)h, \quad \text{or} \quad \Omega = (d\omega)h,$$

where  $(d {}^i \omega)h(X, Y) = d {}^i \omega(hX, hY)$ ,  $(d\omega)h(X, Y) = d\omega(hX, hY)$  for  $X, Y \in \mathcal{X}(P_{M_i})$  or  $X, Y \in \mathcal{X}(\tilde{P})$ . Notice that a 1-form  $\omega h(X_1, X_2) = 0$  if and only if  ${}^i h(X_1) = 0$  or  ${}^i h(X_2) = 0$ . We generalize classical structural equations and Bianchi's identity on principal fiber bundles following.

**Theorem 4.8(E.Cartan)** Let  ${}^i \omega$ ,  $1 \leq i \leq l$  and  $\omega$  be local or global connection forms on a principal fiber bundle  $\tilde{P}^\alpha(\tilde{M}, \mathcal{L}_G)$ . Then

$$(d {}^i \omega)(X, Y) = -[{}^i \omega(X), {}^i \omega(Y)] + {}^i \Omega(X, Y)$$

and

$$d\omega(X, Y) = -[\omega(X), \omega(Y)] + \Omega(X, Y)$$

for vector fields  $X, Y \in \mathcal{X}(P_{M_i})$  or  $\mathcal{X}(\tilde{P})$ .

**Theorem 4.9(Bianchi)** Let  ${}^i \omega$ ,  $1 \leq i \leq l$  and  $\omega$  be local or global connection forms on a principal fiber bundle  $\tilde{P}^\alpha(\tilde{M}, \mathcal{L}_G)$ . Then

$$(d {}^i \Omega)h = 0, \quad \text{and} \quad (d\Omega)h = 0.$$

## §5. Applications

A gauge field is such a mathematical model with local or global symmetries under a group, a finite-dimensional Lie group in most cases action on its gauge basis at an individual point in space and time, together with a set of techniques for making physical predictions consistent with the symmetries of the model, which is a generalization of Einstein's principle of covariance to that of internal field characterized by the following ([3],[23],[24]).

**Gauge Invariant Principle** *A gauge field equation, particularly, the Lagrange density of a gauge field is invariant under gauge transformations on this field.*

We wish to find gauge fields on combinatorial manifolds, and then to characterize WORLD by combinatorics. A *globally or locally combinatorial gauge field* is a combinatorial field  $\widetilde{M}$  under a gauge transformation  $\tau_{\widetilde{M}} : \widetilde{M} \rightarrow \widetilde{M}$  independent or dependent on the field variable  $\overline{x}$ . If a combinatorial gauge field  $\widetilde{M}$  is consisting of gauge fields  $M_1, M_2, \dots, M_m$ , we can easily find that  $\widetilde{M}$  is a globally combinatorial gauge field only if each gauge field is global.

Let  $M_i$ ,  $1 \leq i \leq m$  be gauge fields with a basis  $B_{M_i}$  and  $\tau_i : B_{M_i} \rightarrow B_{M_i}$  a gauge transformation, i.e.,  $\mathcal{L}_{M_i}(B_{M_i}^{\tau_i}) = \mathcal{L}_{M_i}(B_{M_i})$ . A gauge transformation  $\tau_{\widetilde{M}} : \bigcup_{i=1}^m B_{M_i} \rightarrow \bigcup_{i=1}^m B_{M_i}$  is such a transformation on the gauge multi-basis  $\bigcup_{i=1}^m B_{M_i}$  and Lagrange density  $\mathcal{L}_{\widetilde{M}}$  with  $\tau_{\widetilde{M}}|_{M_i} = \tau_i, \mathcal{L}_{\widetilde{M}}|_{M_i} = \mathcal{L}_{M_i}$  for integers  $1 \leq i \leq m$  such that

$$\mathcal{L}_{\widetilde{M}}\left(\bigcup_{i=1}^m B_{M_i}\right)^{\tau_{\widetilde{M}}} = \mathcal{L}_{\widetilde{M}}\left(\bigcup_{i=1}^m B_{M_i}\right).$$

A multibasis  $\bigcup_{i=1}^m B_{M_i}$  is a *combinatorial gauge basis* if for any automorphism  $g \in \text{Aut}G^L[\widetilde{M}]$ ,

$$\mathcal{L}_{\widetilde{M}}\left(\bigcup_{i=1}^m B_{M_i}\right)^{\tau_{\widetilde{M}} \circ g} = \mathcal{L}_{\widetilde{M}}\left(\bigcup_{i=1}^m B_{M_i}\right),$$

where  $\tau_{\widetilde{M}} \circ g$  means  $\tau_{\widetilde{M}}$  compositing with an automorphism  $g$ , a bijection on gauge multi-basis  $\bigcup_{i=1}^m B_{M_i}$ . Whence, a combinatorial field consisting of gauge fields  $M_1, M_2, \dots, M_m$  is a combinatorial gauge field if  $M_1^\alpha = M_2^\alpha$  for  $\forall M_1^\alpha, M_2^\alpha \in \Omega_\alpha$ , where  $\Omega_\alpha$ ,  $1 \leq \alpha \leq s$  are orbits of  $M_1, M_2, \dots, M_m$  under the action of  $\text{Aut}G^L[\widetilde{M}]$ . Therefore, combining existent gauge fields underlying a connected graph  $G$  in space enables us to find more combinatorial gauge fields. For example, combinatorial gravitational fields  $\widetilde{M}(t)$  determined by tensor equations

$$R_{(\mu\nu)(\sigma\tau)} - \frac{1}{2}g_{(\mu\nu)(\sigma\tau)}R = -8\pi G\mathcal{E}_{(\mu\nu)(\sigma\tau)}$$

in a combinatorial Riemannian manifold  $(\widetilde{M}, g, \widetilde{D})$  with  $\widetilde{M} = \widetilde{M}(n_1, n_2, \dots, n_m)$ .

Now let  $\overset{1}{\omega}$  be the local connection 1-form,  $\overset{2}{\Omega} = \widetilde{d}\overset{1}{\omega}$  the curvature 2-form of a local connection on  $\widetilde{P}^\alpha(\widetilde{M}, \mathcal{L}_G)$  and  $\Lambda : \widetilde{M} \rightarrow \widetilde{P}$ ,  $\Pi \circ \Lambda = \text{id}_{\widetilde{M}}$  be a local cross section of  $\widetilde{P}^\alpha(\widetilde{M}, \mathcal{L}_G)$ . Consider

$$\widetilde{A} = \Lambda^* \overset{1}{\omega} = \sum_{\mu\nu} A_{\mu\nu} dx^{\mu\nu},$$

$$\widetilde{F} = \Lambda^* \overset{2}{\Omega} = \sum F_{(\mu\nu)(\kappa\lambda)} dx^{\mu\nu} \wedge dx^{\kappa\lambda}, \quad \widetilde{d}\widetilde{F} = 0,$$

called the *combinatorial gauge potential* and *combinatorial field strength*, respectively. Let

$\gamma : \widetilde{M} \rightarrow \mathbf{R}$  and  $\Lambda' : \widetilde{M} \rightarrow \widetilde{P}$ ,  $\Lambda'(\overline{x}) = e^{i\gamma(\overline{x})}\Lambda(\overline{x})$ . If  $\widetilde{A}' = \Lambda'^* \overset{1}{\omega}$ , then we have

$$\overset{1}{\omega}'(X) = g^{-1} \overset{1}{\omega}(X')g + g^{-1}dg, \quad g \in \mathcal{L}_G,$$

for  $dg \in T_g(\mathcal{L}_G)$ ,  $X = \widetilde{d}R_g X'$  by properties of local connections on combinatorial principal fiber bundles discussed in Section 4.4, which finally yields equations following

$$\widetilde{A}' = \widetilde{A} + \widetilde{d} \widetilde{A}, \quad \widetilde{d} \widetilde{F}' = \widetilde{d} \widetilde{F},$$

i.e., the gauge transformation law on field. This equation enables one to obtain the local form of  $\widetilde{F}$  as they contributions to Maxwell or Yang-Mills fields in classical gauge fields theory.

Certainly, combinatorial fields can be applied to any many-body system in natural or social science, such as those in mechanics, cosmology, physical structure, economics, ..., etc..

## References

- [1] R.Abraham and J.E.Marsden, *Foundation of Mechanics*(2nd edition), Addison-Wesley, Reading, Mass, 1978.
- [2] R.Abraham, J.E.Marsden and T.Ratiu, *Manifolds, Tensors Analysis and Applications*, Addison-Wesley Publishing Company, Inc., 1983.
- [3] D.Bleecker, *Gauge Theory and Variational Principles*, Addison-Wesley Publishing Company, Inc, 1981.
- [4] M.Carmeli, *Classical Fields—General Relativity and Gauge Theory*, World Scientific, 2001.
- [5] W.H.Chern and X.X.Li, *Introduction to Riemannian Geometry* (in Chinese), Peking University Press, 2002.
- [6] J.L.Gross and T.W.Tucker, *Topological Graph Theory*, John Wiley & Sons, 1987.
- [7] H.Iseri, *Smarandache Manifolds*, American Research Press, Rehoboth, NM,2002.
- [8] Linfan Mao, *Automorphism Groups of Maps, Surfaces and Smarandache Geometries*, American Research Press, 2005.
- [9] Linfan Mao, *Smarandache Multi-Space Theory*, Hexis, Phoenix,American 2006.
- [10] Linfan Mao, Smarandache multi-spaces with related mathematical combinatorics, in Yi Yuan and Kang Xiaoyu ed. *Research on Smarandache Problems*, High American Press, 2006.
- [11] Linfan Mao, Combinatorial speculation and combinatorial conjecture for mathematics, *International J.Math. Combin.* Vol.1(2007), No.1, 1-19.
- [12] Linfan Mao, An introduction to Smarandache multi-spaces and mathematical combinatorics, *Scientia Magna*, Vol.3, No.1(2007), 54-80.
- [13] Linfan Mao, Geometrical theory on combinatorial manifolds, *JP J.Geometry and Topology*, Vol.7, No.1(2007),65-114.
- [14] Linfan Mao, Curvature equations on combinatorial manifolds with applications to theoretical physics, *International J.Math.Combin.*, Vol.1(2008), No.1, 16-35.
- [15] Linfan Mao, Combinatorially Riemannian Submanifolds, *International J. Math.Combin.*,

- Vol. 2(2008), No.1, 23-45.
- [16] Linfan Mao, Topological multi-groups and multi-fields, *International J.Math. Combin.* Vol.1 (2009), 08-17.
  - [17] Linfan Mao, *Combinatorial Geometry with applications to Field Theory*, InfoQuest, USA, 2009.
  - [18] W.S.Massey, *Algebraic topology: an introduction*, Springer-Verlag, New York, etc.(1977).
  - [19] W.S.Massey, *Singular Homology Theory*, Springer-Verlag, New York, etc.(1980).
  - [20] Michio Kaku, *Parallel Worlds*, Doubleday, An imprint of Random House, 2004.
  - [21] E.Papantonopoulos, Braneworld cosmological models, *arXiv: gr-qc/0410032*.
  - [22] E.Papantonopoulos, Cosmology in six dimensions, *arXiv: gr-qc/0601011*.
  - [23] T.M.Wang, *Concise Quantum Field Theory* (in Chinese), Peking University Press, 2008.
  - [24] C.Von Westenholz, *Differential Forms in Mathematical Physics* (Revised edition), North-Holland Publishing Company, 1981.

## Curvature Equations on Combinatorial Manifolds with Applications to Theoretical Physics

**Abstract** Curvature equations are very important in theoretical physics for describing various classical fields, particularly for gravitational field by Einstein. For applying Smarandache multispaces to *parallel universes*, the conception of combinatorial manifolds was introduced under a combinatorial speculation for mathematical sciences in [9], which are similar to manifolds in the local but different in the global. Similarly, we introduce curvatures on combinatorial manifolds and find their structural equations in this paper. These Einstein's equations for a gravitational field are established again by the choice of a combinatorial Riemannian manifold as its spacetime and some multi-space solutions for these new equations are also gotten by applying the *projective principle* on multi-spaces in this paper.

**Key Words:** curvature, combinatorial manifold, combinatorially Euclidean space, equations of gravitational field, multi-space solution.

**AMS(2000):** 51M15, 53B15, 53B40, 57N16, 83C05, 83F05.

### §1. Introduction

As an efficiently mathematical tool used by Einstein in his general relativity, tensor analysis mainly dealt with transformations on manifolds had gotten considerable developments by both mathematicians and physicists in last century. Among all of these, much concerns were concentrated on an important tensor called curvature tensor for understanding the behavior of curved spaces. For example, the famous Einstein's gravitational field equations

$$R_{\mu\nu} - \frac{1}{2}g_{\mu\nu}R = -8\pi GT_{\mu\nu}$$

are consisted of curvature tensors and energy-momentum tensors of the curved space.

Notice that all curved spaces considered in classical fields are homogenous. Achievements of physics had shown that the multiple behavior of the cosmos in last century, enables the model of parallel universe for the cosmos born([14]). Then *can we construct a new mathematical theory, or generalized manifolds usable for this multiple, non-homogenous physics appeared in 21st century?* The answer is YES in logic at least. That is the *Smarandache multi-space theory*, see [7] for details.

For applying Smarandache multispaces to *parallel universes*, combinatorial manifolds were introduced endowed with a topological or differential structure under a combinatorial speculation for mathematical sciences in [9], i.e. *mathematics can be reconstructed from or turned into combinatorization*([8]), which are similar to manifolds in the local but different in the

---

<sup>1</sup>*International J. Math. Combin.*, Vol.1 (2008), 16-35

global. Whence, geometries on combinatorial manifolds are nothing but these *Smarandache geometries* ([12]-[13]).

Now we introduce the conception of combinatorial manifolds in the following. For an integer  $s \geq 1$ , let  $n_1, n_2, \dots, n_s$  be an integer sequence with  $0 < n_1 < n_2 < \dots < n_s$ . Choose  $s$  open unit balls  $B_1^{n_1}, B_2^{n_2}, \dots, B_s^{n_s}$  with  $\bigcap_{i=1}^s B_i^{n_i} \neq \emptyset$  in  $\mathbf{R}^n$ , where  $n = n_1 + n_2 + \dots + n_s$ . A *unit open combinatorial ball of degree  $s$*  is a union

$$\tilde{B}(n_1, n_2, \dots, n_s) = \bigcup_{i=1}^s B_i^{n_i}.$$

A combinatorial manifold  $\tilde{M}$  is defined in the next.

**Definition 1.1** For a given integer sequence  $n_1, n_2, \dots, n_m, m \geq 1$  with  $0 < n_1 < n_2 < \dots < n_m$ , a combinatorial manifold  $\tilde{M}$  is a Hausdorff space such that for any point  $p \in \tilde{M}$ , there is a local chart  $(U_p, \varphi_p)$  of  $p$ , i.e., an open neighborhood  $U_p$  of  $p$  in  $\tilde{M}$  and a homoeomorphism  $\varphi_p : U_p \rightarrow \tilde{B}(n_1(p), n_2(p), \dots, n_{s(p)}(p))$  with  $\{n_1(p), n_2(p), \dots, n_{s(p)}(p)\} \subseteq \{n_1, n_2, \dots, n_m\}$  and  $\bigcup_{p \in \tilde{M}} \{n_1(p), n_2(p), \dots, n_{s(p)}(p)\} = \{n_1, n_2, \dots, n_m\}$ , denoted by  $\tilde{M}(n_1, n_2, \dots, n_m)$  or  $\tilde{M}$  on the context and

$$\tilde{\mathcal{A}} = \{(U_p, \varphi_p) | p \in \tilde{M}(n_1, n_2, \dots, n_m)\}$$

an atlas on  $\tilde{M}(n_1, n_2, \dots, n_m)$ . The maximum value of  $s(p)$  and the dimension  $\hat{s}(p)$  of  $\bigcap_{i=1}^{s(p)} B_i^{n_i}$  are called the *dimension* and the *intersectional dimension* of  $\tilde{M}(n_1, n_2, \dots, n_m)$  at the point  $p$ , denoted by  $d(p)$  and  $\hat{d}(p)$ , respectively.

A combinatorial manifold  $\tilde{M}$  is called *finite* if it is just combined by finite manifolds without one manifold contained in the union of others, is called *smooth* if it is finite endowed with a  $C^\infty$  differential structure. For a smoothly combinatorial manifold  $\tilde{M}$  and a point  $p \in \tilde{M}$ , it has been shown in [9] that  $\dim T_p \tilde{M}(n_1, n_2, \dots, n_m) = \hat{s}(p) + \sum_{i=1}^{s(p)} (n_i - \hat{s}(p))$  and

$\dim T_p^* \tilde{M}(n_1, n_2, \dots, n_m) = \hat{s}(p) + \sum_{i=1}^{s(p)} (n_i - \hat{s}(p))$  with a basis

$$\left\{ \frac{\partial}{\partial x^{hj}} \Big|_p \mid 1 \leq j \leq \hat{s}(p) \right\} \bigcup \left( \bigcup_{i=1}^{s(p)} \bigcup_{j=\hat{s}(p)+1}^{n_i} \left\{ \frac{\partial}{\partial x^{ij}} \Big|_p \mid 1 \leq j \leq s \right\} \right)$$

or

$$\left\{ dx^{hj} \Big|_p \mid 1 \leq j \leq \hat{s}(p) \right\} \bigcup \left( \bigcup_{i=1}^{s(p)} \bigcup_{j=\hat{s}(p)+1}^{n_i} \left\{ dx^{ij} \Big|_p \mid 1 \leq j \leq s \right\} \right)$$

for a given integer  $h, 1 \leq h \leq s(p)$ .

**Definition 1.2** A connection  $\tilde{D}$  on a smoothly combinatorial manifold  $\tilde{M}$  is a mapping  $\tilde{D} : \mathcal{X}(\tilde{M}) \times T_s^r \tilde{M} \rightarrow T_s^r \tilde{M}$  on tensors of  $\tilde{M}$  with  $\tilde{D}_X \tau = \tilde{D}(X, \tau)$  such that for  $\forall X, Y \in \mathcal{X} \tilde{M}$ ,

$\tau, \pi \in T_s^r(\widetilde{M}), \lambda \in \mathbf{R}$  and  $f \in C^\infty(\widetilde{M})$ ,

- (1)  $\widetilde{D}_{X+fY}\tau = \widetilde{D}_X\tau + f\widetilde{D}_Y\tau$ ; and  $\widetilde{D}_X(\tau + \lambda\pi) = \widetilde{D}_X\tau + \lambda\widetilde{D}_X\pi$ ;
- (2)  $\widetilde{D}_X(\tau \otimes \pi) = \widetilde{D}_X\tau \otimes \pi + \sigma \otimes \widetilde{D}_X\pi$ ;
- (3) for any contraction  $C$  on  $T_s^r(\widetilde{M})$ ,  $\widetilde{D}_X(C(\tau)) = C(\widetilde{D}_X\tau)$ .

A combinatorially connection space is a 2-tuple  $(\widetilde{M}, \widetilde{D})$  consisting of a smoothly combinatorial manifold  $\widetilde{M}$  with a connection  $\widetilde{D}$  and a torsion tensor  $\widetilde{T} : \mathcal{X}(\widetilde{M}) \times \mathcal{X}(\widetilde{M}) \rightarrow \mathcal{X}(\widetilde{M})$  on  $(\widetilde{M}, \widetilde{D})$  is defined by  $\widetilde{T}(X, Y) = \widetilde{D}_X Y - \widetilde{D}_Y X - [X, Y]$  for  $\forall X, Y \in \mathcal{X}(\widetilde{M})$ . If  $\widetilde{T}|_U(X, Y) \equiv 0$  in a local chart  $(U, [\varphi])$ , then  $\widetilde{D}$  is called torsion-free on  $(U, [\varphi])$ .

Similar to that of Riemannian geometry, metrics on a smoothly combinatorial manifold and the combinatorially Riemannian geometry are defined in next definition.

**Definition 1.3** Let  $\widetilde{M}$  be a smoothly combinatorial manifold and  $g \in A^2(\widetilde{M}) = \bigcup_{p \in \widetilde{M}} T_2^0(p, \widetilde{M})$ .

If  $g$  is symmetrical and positive, then  $\widetilde{M}$  is called a combinatorially Riemannian manifold, denoted by  $(\widetilde{M}, g)$ . In this case, if there is a connection  $\widetilde{D}$  on  $(\widetilde{M}, g)$  with equality following hold

$$Z(g(X, Y)) = g(\widetilde{D}_Z, Y) + g(X, \widetilde{D}_Z Y)$$

then  $\widetilde{M}$  is called a combinatorially Riemannian geometry, denoted by  $(\widetilde{M}, g, \widetilde{D})$ .

It has been showed that there exists a unique connection  $\widetilde{D}$  on  $(\widetilde{M}, g)$  such that  $(\widetilde{M}, g, \widetilde{D})$  is a combinatorially Riemannian geometry in [9].

We all known that curvature equations are very important in theoretical physics for describing various classical fields, particularly for gravitational field by Einstein. The main purpose of this paper is to establish curvature tensors with equations on combinatorial manifolds and apply them to describe the gravitational field. For this objective, we introduce the conception of curvatures on combinatorial manifolds and establish symmetrical relations for curvature tensors, particularly for combinatorially Riemannian manifolds in the next two sections. Structural equations of curvature tensors on combinatorial manifolds are also established. These generalized Einstein's equations of gravitational field on combinatorially Riemannian manifolds are constructed in Section 4. By applying the *projective principle* on multi-spaces, multi-space solutions for these new equations are gotten in Section 5.

Terminologies and notations used in this paper are standard and can be found in [1], [4] for those of manifolds [9] – [11] for combinatorial manifolds and [6] – [7] for graphs, respectively.

### §2. Curvatures on Combinatorially Connection Spaces

As a first step for introducing curvatures on combinatorial manifolds, we define combinatorially curvature operators on smoothly combinatorial manifolds in the next.

**Definition 2.1** Let  $(\widetilde{M}, \widetilde{D})$  be a combinatorially connection space. For  $\forall X, Y \in \mathcal{X}(\widetilde{M})$ , a

combinatorially curvature operator  $\tilde{\mathcal{R}}(X, Y) : \mathcal{X}(\tilde{M}) \rightarrow \mathcal{X}(\tilde{M})$  is defined by

$$\tilde{\mathcal{R}}(X, Y)Z = \tilde{D}_X \tilde{D}_Y Z - \tilde{D}_Y \tilde{D}_X Z - \tilde{D}_{[X, Y]}Z$$

for  $\forall Z \in \mathcal{X}(\tilde{M})$ .

For a given combinatorially connection space  $(\tilde{M}, \tilde{D})$ , we know properties following on combinatorially curvature operators similar to those of the Riemannian geometry.

**Theorem 2.1** *Let  $(\tilde{M}, \tilde{D})$  be a combinatorially connection space. Then for  $\forall X, Y, Z \in \mathcal{X}(\tilde{M})$ ,  $\forall f \in C^\infty(\tilde{M})$ ,*

- (1)  $\tilde{\mathcal{R}}(X, Y) = -\tilde{\mathcal{R}}(Y, X)$ ;
- (2)  $\tilde{\mathcal{R}}(fX, Y) = \tilde{\mathcal{R}}(X, fY) = f\tilde{\mathcal{R}}(X, Y)$ ;
- (3)  $\tilde{\mathcal{R}}(X, Y)(fZ) = f\tilde{\mathcal{R}}(X, Y)Z$ .

*Proof* For  $\forall X, Y, Z \in \mathcal{X}(\tilde{M})$ , we know that  $\tilde{\mathcal{R}}(X, Y)Z = -\tilde{\mathcal{R}}(Y, X)Z$  by definition. Whence,  $\tilde{\mathcal{R}}(X, Y) = -\tilde{\mathcal{R}}(Y, X)$ .

Now since

$$\begin{aligned} \tilde{\mathcal{R}}(fX, Y)Z &= \tilde{D}_{fX} \tilde{D}_Y Z - \tilde{D}_Y \tilde{D}_{fX} Z - \tilde{D}_{[fX, Y]}Z \\ &= f\tilde{D}_X \tilde{D}_Y Z - \tilde{D}_Y (f\tilde{D}_X Z) - \tilde{D}_{f[X, Y] - Y(f)X}Z \\ &= f\tilde{D}_X \tilde{D}_Y Z - Y(f)\tilde{D}_X Z - f\tilde{D}_Y \tilde{D}_X Z \\ &\quad - f\tilde{D}_{[X, Y]}Z + Y(f)\tilde{D}_X Z \\ &= f\tilde{\mathcal{R}}(X, Y)Z, \end{aligned}$$

we get that  $\tilde{\mathcal{R}}(fX, Y) = f\tilde{\mathcal{R}}(X, Y)$ . Applying the quality (1), we find that

$$\tilde{\mathcal{R}}(X, fY) = -\tilde{\mathcal{R}}(fY, X) = -f\tilde{\mathcal{R}}(Y, X) = f\tilde{\mathcal{R}}(X, Y).$$

This establishes (2). Now calculation shows that

$$\begin{aligned} \tilde{\mathcal{R}}(X, Y)(fZ) &= \tilde{D}_X \tilde{D}_Y (fZ) - \tilde{D}_Y \tilde{D}_X (fZ) - \tilde{D}_{[X, Y]}(fZ) \\ &= \tilde{D}_X (Y(f)Z + f\tilde{D}_Y Z) - \tilde{D}_Y (X(f)Z + f\tilde{D}_X Z) \\ &\quad - ([X, Y](f))Z - f\tilde{D}_{[X, Y]}Z \\ &= X(Y(f))Z + Y(f)\tilde{D}_X Z + X(f)\tilde{D}_Y Z \\ &\quad + f\tilde{D}_X \tilde{D}_Y Z - Y(X(f))Z - X(f)\tilde{D}_Y Z - Y(f)\tilde{D}_X Z \\ &\quad - f\tilde{D}_Y \tilde{D}_X Z - ([X, Y](f))Z - f\tilde{D}_{[X, Y]}Z \\ &= f\tilde{\mathcal{R}}(X, Y)Z. \end{aligned}$$

Whence, we know that

$$\tilde{\mathcal{R}}(X, Y)(fZ) = f\tilde{\mathcal{R}}(X, Y)Z. \quad \square$$



**Theorem 2.2** Let  $(\widetilde{M}, \widetilde{D})$  be a combinatorially connection space. If the torsion tensor  $\widetilde{T} \equiv 0$  on  $\widetilde{D}$ , then the first and second Bianchi equalities following hold.

$$\widetilde{\mathcal{R}}(X, Y)Z + \widetilde{\mathcal{R}}(Y, Z)X + \widetilde{\mathcal{R}}(Z, X)Y = 0$$

and

$$(\widetilde{D}_X \widetilde{R})(Y, Z)W + (\widetilde{D}_Y \widetilde{R})(Z, X)W + (\widetilde{D}_Z \widetilde{R})(X, Y)W = 0.$$

*Proof* Notice that  $\widetilde{T} \equiv 0$  is equal to  $\widetilde{D}_X Y - \widetilde{D}_Y X = [X, Y]$  for  $\forall X, Y \in \mathcal{X}(\widetilde{M})$ . Thereafter, we know that

$$\begin{aligned} & \widetilde{\mathcal{R}}(X, Y)Z + \widetilde{\mathcal{R}}(Y, Z)X + \widetilde{\mathcal{R}}(Z, X)Y \\ &= \widetilde{D}_X \widetilde{D}_Y Z - \widetilde{D}_Y \widetilde{D}_X Z - \widetilde{D}_{[X, Y]} Z + \widetilde{D}_Y \widetilde{D}_Z X - \widetilde{D}_Z \widetilde{D}_Y X \\ & - \widetilde{D}_{[Y, Z]} X + \widetilde{D}_Z \widetilde{D}_X Y - \widetilde{D}_X \widetilde{D}_Z Y - \widetilde{D}_{[Z, X]} Y \\ &= \widetilde{D}_X (\widetilde{D}_Y Z - \widetilde{D}_Z Y) - \widetilde{D}_{[Y, Z]} X + \widetilde{D}_Y (\widetilde{D}_Z X - \widetilde{D}_X Z) \\ & - \widetilde{D}_{[Z, X]} Y + \widetilde{D}_Z (\widetilde{D}_X Y - \widetilde{D}_Y X) - \widetilde{D}_{[X, Y]} Z \\ &= \widetilde{D}_X [Y, Z] - \widetilde{D}_{[Y, Z]} X + \widetilde{D}_Y [Z, X] - \widetilde{D}_{[Z, X]} Y \\ & + \widetilde{D}_Z [X, Y] - \widetilde{D}_{[X, Y]} Z \\ &= [X, [Y, Z]] + [Y, [Z, X]] + [Z, [X, Y]]. \end{aligned}$$

By the Jacobi equality  $[X, [Y, Z]] + [Y, [Z, X]] + [Z, [X, Y]] = 0$ , we get that

$$\widetilde{\mathcal{R}}(X, Y)Z + \widetilde{\mathcal{R}}(Y, Z)X + \widetilde{\mathcal{R}}(Z, X)Y = 0.$$

By definition, we know that

$$\begin{aligned} & (\widetilde{D}_X \widetilde{R})(Y, Z)W = \\ & \widetilde{D}_X \widetilde{R}(Y, Z)W - \widetilde{R}(\widetilde{D}_X Y, Z)W - \widetilde{R}(Y, \widetilde{D}_X Z)W - \widetilde{R}(Y, Z)\widetilde{D}_X W \\ &= \widetilde{D}_X \widetilde{D}_Y \widetilde{D}_Z W - \widetilde{D}_X \widetilde{D}_Z \widetilde{D}_Y W - \widetilde{D}_X \widetilde{D}_{[Y, Z]} W - \widetilde{D}_{\widetilde{D}_X Y} \widetilde{D}_Z W \\ & + \widetilde{D}_Z \widetilde{D}_{\widetilde{D}_X Y} W + \widetilde{D}_{[\widetilde{D}_X Y, Z]} W - \widetilde{D}_Y \widetilde{D}_{\widetilde{D}_X Z} W + \widetilde{D}_{\widetilde{D}_X Z} \widetilde{D}_Y W \\ & + \widetilde{D}_{[Y, \widetilde{D}_X Z]} W - \widetilde{D}_Y \widetilde{D}_Z \widetilde{D}_X W + \widetilde{D}_Z \widetilde{D}_Y \widetilde{D}_X W + \widetilde{D}_{[Y, Z]} \widetilde{D}_X W. \end{aligned}$$

Let

$$\begin{aligned} A^W(X, Y, Z) &= \widetilde{D}_X \widetilde{D}_Y \widetilde{D}_Z W - \widetilde{D}_X \widetilde{D}_Z \widetilde{D}_Y W - \widetilde{D}_Y \widetilde{D}_Z \widetilde{D}_X W + \widetilde{D}_Z \widetilde{D}_Y \widetilde{D}_X W, \\ B^W(X, Y, Z) &= -\widetilde{D}_X \widetilde{D}_{\widetilde{D}_Y Z} W + \widetilde{D}_X \widetilde{D}_{\widetilde{D}_Z Y} W + \widetilde{D}_Z \widetilde{D}_{\widetilde{D}_X Y} W - \widetilde{D}_Y \widetilde{D}_{\widetilde{D}_X Z} W, \\ C^W(X, Y, Z) &= -\widetilde{D}_{\widetilde{D}_X Y} \widetilde{D}_Z W + \widetilde{D}_{\widetilde{D}_X Z} \widetilde{D}_Y W + \widetilde{D}_{\widetilde{D}_Y Z} \widetilde{D}_X W - \widetilde{D}_{\widetilde{D}_Z Y} \widetilde{D}_X W \end{aligned}$$

and

$$D^W(X, Y, Z) = \widetilde{D}_{[\widetilde{D}_X Y, Z]} W - \widetilde{D}_{[\widetilde{D}_X Z, Y]} W.$$

Applying the equality  $\tilde{D}_X Y - \tilde{D}_Y X = [X, Y]$ , we find that

$$(\tilde{D}_X \tilde{R})(Y, Z)W = A^W(X, Y, Z) + B^W(X, Y, Z) + C^W(X, Y, Z) + D^W(X, Y, Z).$$

We can check immediately that

$$\begin{aligned} A^W(X, Y, Z) + A^W(Y, Z, X) + A^W(Z, X, Y) &= 0, \\ B^W(X, Y, Z) + B^W(Y, Z, X) + B^W(Z, X, Y) &= 0, \\ C^W(X, Y, Z) + C^W(Y, Z, X) + C^W(Z, X, Y) &= 0 \end{aligned}$$

and

$$\begin{aligned} D^W(X, Y, Z) + D^W(Y, Z, X) + D^W(Z, X, Y) \\ = \tilde{D}_{[X, [Y, Z]] + [Y, [Z, X]] + [Z, [X, Y]]} W = \tilde{D}_0 W = 0 \end{aligned}$$

by the Jacobi equality  $[X, [Y, Z]] + [Y, [Z, X]] + [Z, [X, Y]] = 0$ . Therefore, we get finally that

$$\begin{aligned} (\tilde{D}_X \tilde{R})(Y, Z)W + (\tilde{D}_Y \tilde{R})(Z, X)W + (\tilde{D}_Z \tilde{R})(X, Y)W \\ = A^W(X, Y, Z) + B^W(X, Y, Z) + C^W(X, Y, Z) + D^W(X, Y, Z) \\ + A^W(Y, Z, X) + B^W(Y, Z, X) + C^W(Y, Z, X) + D^W(Y, Z, X) \\ + A^W(Z, X, Y) + B^W(Z, X, Y) + C^W(Z, X, Y) + D^W(Z, X, Y) = 0. \end{aligned}$$

This completes the proof.  $\square$

According to Theorem 2.1, the curvature operator  $\tilde{\mathcal{R}}(X, Y) : \mathcal{X}(\tilde{M}) \rightarrow \mathcal{X}(\tilde{M})$  is a tensor of type  $(1, 1)$ . By applying this operator, we can define a curvature tensor in the next definition.

**Definition 2.2** Let  $(\tilde{M}, \tilde{D})$  be a combinatorially connection space. For  $\forall X, Y, Z \in \mathcal{X}(\tilde{M})$ , a linear multi-mapping  $\tilde{\mathcal{R}} : \mathcal{X}(\tilde{M}) \times \mathcal{X}(\tilde{M}) \times \mathcal{X}(\tilde{M}) \rightarrow \mathcal{X}(\tilde{M})$  determined by

$$\tilde{\mathcal{R}}(Z, X, Y) = \tilde{\mathcal{R}}(X, Y)Z$$

is said a curvature tensor of type  $(1, 3)$  on  $(\tilde{M}, \tilde{D})$ .

Let  $(\tilde{M}, \tilde{D})$  be a combinatorially connection space and

$$\{e_{ij} | 1 \leq i \leq s(p), 1 \leq j \leq n_i \text{ and } e_{i_1 j} = e_{i_2 j} \text{ for } 1 \leq i_1, i_2 \leq s(p) \text{ if } 1 \leq j \leq \hat{s}(p)\}$$

a local frame with a dual

$$\{\omega^{ij} | 1 \leq i \leq s(p), 1 \leq j \leq n_i \text{ and } \omega^{i_1 j} = \omega^{i_2 j} \text{ for } 1 \leq i_1, i_2 \leq s(p) \text{ if } 1 \leq j \leq \hat{s}(p)\},$$

abbreviated to  $\{e_{ij}\}$  and  $\{\omega^{ij}\}$  at a point  $p \in \tilde{M}$ , where  $\tilde{M} = \tilde{M}(n_1, n_2, \dots, n_m)$ . Then there

exist smooth functions  $\Gamma_{(\mu\nu)(\kappa\lambda)}^{\sigma\varsigma} \in C^\infty(\widetilde{M})$  such that

$$\widetilde{D}_{e_{\kappa\lambda}} e_{\mu\nu} = \Gamma_{(\mu\nu)(\kappa\lambda)}^{\sigma\varsigma} e_{\sigma\varsigma}$$

called connection coefficients in the local frame  $\{e_{ij}\}$ . Define

$$\omega_{\mu\nu}^{\sigma\varsigma} = \Gamma_{(\mu\nu)(\kappa\lambda)}^{\sigma\varsigma} \omega^{\kappa\lambda}.$$

We get that

$$\widetilde{D}e_{\kappa\lambda} = \omega_{\mu\nu}^{\sigma\varsigma} e_{\sigma\varsigma}.$$

**Theorem 2.3** *Let  $(\widetilde{M}, \widetilde{D})$  be a combinatorially connection space and  $\{e_{ij}\}$  a local frame with a dual  $\{\omega^{ij}\}$  at a point  $p \in \widetilde{M}$ . Then*

$$\widetilde{d}\omega^{\mu\nu} - \omega^{\kappa\lambda} \wedge \omega_{\kappa\lambda}^{\mu\nu} = \frac{1}{2} \widetilde{T}_{(\kappa\lambda)(\sigma\varsigma)}^{\mu\nu} \omega^{\kappa\lambda} \wedge \omega^{\sigma\varsigma},$$

where  $\widetilde{T}_{(\kappa\lambda)(\sigma\varsigma)}^{\mu\nu}$  is a component of the torsion tensor  $\widetilde{T}$  in the frame  $\{e_{ij}\}$ , i.e.,  $\widetilde{T}_{(\kappa\lambda)(\sigma\varsigma)}^{\mu\nu} = \omega^{\mu\nu}(\widetilde{T}(e_{\kappa\lambda}, e_{\sigma\varsigma}))$  and

$$\widetilde{d}\omega_{\mu\nu}^{\kappa\lambda} - \omega_{\mu\nu}^{\sigma\varsigma} \wedge \omega_{\sigma\varsigma}^{\kappa\lambda} = \frac{1}{2} \widetilde{R}_{(\mu\nu)(\sigma\varsigma)(\eta\theta)}^{\kappa\lambda} \omega^{\sigma\varsigma} \wedge \omega^{\eta\theta}$$

with  $\widetilde{R}_{(\mu\nu)(\sigma\varsigma)(\eta\theta)}^{\kappa\lambda} e_{\kappa\lambda} = \widetilde{R}(e_{\sigma\varsigma}, e_{\eta\theta}) e_{\mu\nu}$ .

*Proof* By definition, for any given  $e_{\sigma\varsigma}, e_{\eta\theta}$  we know that (see Theorem 3.6 in [9])

$$\begin{aligned} (\widetilde{d}\omega^{\mu\nu} - \omega^{\kappa\lambda} \wedge \omega_{\kappa\lambda}^{\mu\nu})(e_{\sigma\varsigma}, e_{\eta\theta}) &= e_{\sigma\varsigma}(\omega^{\mu\nu}(e_{\eta\theta})) - e_{\eta\theta}(\omega^{\mu\nu}(e_{\sigma\varsigma})) - \omega^{\mu\nu}([e_{\sigma\varsigma}, e_{\eta\theta}]) \\ &\quad - \omega^{\kappa\lambda}(e_{\sigma\varsigma}) \omega_{\kappa\lambda}^{\mu\nu}(e_{\eta\theta}) + \omega^{\kappa\lambda}(e_{\eta\theta}) \omega_{\kappa\lambda}^{\mu\nu}(e_{\sigma\varsigma}) \\ &= -\omega_{\sigma\varsigma}^{\mu\nu}(e_{\eta\theta}) + \omega_{\eta\theta}^{\mu\nu}(e_{\sigma\varsigma}) - \omega^{\mu\nu}([e_{\sigma\varsigma}, e_{\eta\theta}]) \\ &= -\Gamma_{(\sigma\varsigma)(\eta\theta)}^{\mu\nu} + \Gamma_{(\eta\theta)(\sigma\varsigma)}^{\mu\nu} - \omega^{\mu\nu}([e_{\sigma\varsigma}, e_{\eta\theta}]) \\ &= \omega^{\mu\nu}(\widetilde{D}_{e_{\sigma\varsigma}} e_{\eta\theta} - \widetilde{D}_{e_{\eta\theta}} e_{\sigma\varsigma} - [e_{\sigma\varsigma}, e_{\eta\theta}]) \\ &= \omega^{\mu\nu}(\widetilde{T}(e_{\sigma\varsigma}, e_{\eta\theta})) = \widetilde{T}_{(\sigma\varsigma)(\eta\theta)}^{\mu\nu}. \end{aligned}$$

Whence,

$$\widetilde{d}\omega^{\mu\nu} - \omega^{\kappa\lambda} \wedge \omega_{\kappa\lambda}^{\mu\nu} = \frac{1}{2} \widetilde{T}_{(\kappa\lambda)(\sigma\varsigma)}^{\mu\nu} \omega^{\kappa\lambda} \wedge \omega^{\sigma\varsigma}.$$

Now since

$$\begin{aligned} &(\widetilde{d}\omega_{\mu\nu}^{\kappa\lambda} - \omega_{\mu\nu}^{\vartheta\iota} \wedge \omega_{\vartheta\iota}^{\kappa\lambda})(e_{\sigma\varsigma}, e_{\eta\theta}) \\ &= e_{\sigma\varsigma}(\omega_{\mu\nu}^{\kappa\lambda}(e_{\eta\theta})) - e_{\eta\theta}(\omega_{\mu\nu}^{\kappa\lambda}(e_{\sigma\varsigma})) - \omega_{\mu\nu}^{\kappa\lambda}([e_{\sigma\varsigma}, e_{\eta\theta}]) \\ &\quad - \omega_{\mu\nu}^{\vartheta\iota}(e_{\sigma\varsigma}) \omega_{\vartheta\iota}^{\kappa\lambda}(e_{\eta\theta}) + \omega_{\mu\nu}^{\vartheta\iota}(e_{\eta\theta}) \omega_{\vartheta\iota}^{\kappa\lambda}(e_{\sigma\varsigma}) \\ &= e_{\sigma\varsigma}(\Gamma_{(\mu\nu)(\eta\theta)}^{\kappa\lambda}) - e_{\eta\theta}(\Gamma_{(\mu\nu)(\sigma\varsigma)}^{\kappa\lambda}) - \omega^{\vartheta\iota}([e_{\sigma\varsigma}, e_{\eta\theta}]) \Gamma_{(\mu\nu)(\vartheta\iota)}^{\kappa\lambda} \\ &\quad - \Gamma_{(\mu\nu)(\sigma\varsigma)}^{\vartheta\iota} \Gamma_{(\vartheta\iota)(\eta\theta)}^{\kappa\lambda} + \Gamma_{(\mu\nu)(\eta\theta)}^{\vartheta\iota} \Gamma_{(\vartheta\iota)(\sigma\varsigma)}^{\kappa\lambda} \end{aligned}$$

and

$$\begin{aligned}
\tilde{R}(e_{\sigma\varsigma}, e_{\eta\theta})e_{\mu\nu} &= \tilde{D}_{e_{\sigma\varsigma}}\tilde{D}_{e_{\eta\theta}}e_{\mu\nu} - \tilde{D}_{e_{\eta\theta}}\tilde{D}_{e_{\sigma\varsigma}}e_{\mu\nu} - \tilde{D}_{[e_{\sigma\varsigma}, e_{\eta\theta}]}e_{\mu\nu} \\
&= \tilde{D}_{e_{\sigma\varsigma}}(\Gamma_{(\mu\nu)(\eta\theta)}^{\kappa\lambda}e_{\kappa\lambda}) - \tilde{D}_{e_{\eta\theta}}(\Gamma_{(\mu\nu)(\sigma\varsigma)}^{\kappa\lambda}e_{\kappa\lambda}) - \omega^{\vartheta\iota}([e_{\sigma\varsigma}, e_{\eta\theta}])\Gamma_{(\mu\nu)(\vartheta\iota)}^{\kappa\lambda}e_{\kappa\lambda} \\
&= (e_{\sigma\varsigma}(\Gamma_{(\mu\nu)(\eta\theta)}^{\kappa\lambda}) - e_{\eta\theta}(\Gamma_{(\mu\nu)(\sigma\varsigma)}^{\kappa\lambda}) + \Gamma_{(\mu\nu)(\eta\theta)}^{\vartheta\iota}\Gamma_{(\vartheta\iota)(\sigma\varsigma)}^{\kappa\lambda}) \\
&\quad - \Gamma_{(\mu\nu)(\sigma\varsigma)}^{\vartheta\iota}\Gamma_{(\vartheta\iota)(\eta\theta)}^{\kappa\lambda} - \omega^{\vartheta\iota}([e_{\sigma\varsigma}, e_{\eta\theta}])\Gamma_{(\mu\nu)(\vartheta\iota)}^{\kappa\lambda}e_{\kappa\lambda} \\
&= (\tilde{d}\omega_{\mu\nu}^{\kappa\lambda} - \omega_{\mu\nu}^{\vartheta\iota} \wedge \omega_{\vartheta\iota}^{\kappa\lambda})(e_{\sigma\varsigma}, e_{\eta\theta})e_{\kappa\lambda}.
\end{aligned}$$

Therefore, we get that

$$(\tilde{d}\omega_{\mu\nu}^{\kappa\lambda} - \omega_{\mu\nu}^{\vartheta\iota} \wedge \omega_{\vartheta\iota}^{\kappa\lambda})(e_{\sigma\varsigma}, e_{\eta\theta}) = \tilde{R}_{(\mu\nu)(\sigma\varsigma)(\eta\theta)}^{\kappa\lambda},$$

that is,

$$\tilde{d}\omega_{\mu\nu}^{\kappa\lambda} - \omega_{\mu\nu}^{\sigma\varsigma} \wedge \omega_{\sigma\varsigma}^{\kappa\lambda} = \frac{1}{2}\tilde{R}_{(\mu\nu)(\sigma\varsigma)(\eta\theta)}^{\kappa\lambda}\omega^{\sigma\varsigma} \wedge \omega^{\eta\theta}. \quad \square$$

**Definition 2.3** Let  $(\tilde{M}, \tilde{D})$  be a combinatorially connection space. Differential 2-forms  $\Omega^{\mu\nu} = \tilde{d}\omega^{\mu\nu} - \omega^{\mu\nu} \wedge \omega_{\kappa\lambda}^{\mu\nu}$ ,  $\Omega_{\mu\nu}^{\kappa\lambda} = \tilde{d}\omega_{\mu\nu}^{\kappa\lambda} - \omega_{\mu\nu}^{\sigma\varsigma} \wedge \omega_{\sigma\varsigma}^{\kappa\lambda}$  and equations

$$\tilde{d}\omega^{\mu\nu} = \omega^{\kappa\lambda} \wedge \omega_{\kappa\lambda}^{\mu\nu} + \Omega^{\mu\nu}, \quad \tilde{d}\omega_{\mu\nu}^{\kappa\lambda} = \omega_{\mu\nu}^{\sigma\varsigma} \wedge \omega_{\sigma\varsigma}^{\kappa\lambda} + \Omega_{\mu\nu}^{\kappa\lambda}$$

are called torsion forms, curvature forms and structural equations in a local frame  $\{e_{ij}\}$  of  $(\tilde{M}, \tilde{D})$ , respectively.

By Theorem 2.3 and Definition 2.3, we get local forms for torsion tensor and curvature tensor in a local frame following.

**Corollary 2.1** Let  $(\tilde{M}, \tilde{D})$  be a combinatorially connection space and  $\{e_{ij}\}$  a local frame with a dual  $\{\omega^{ij}\}$  at a point  $p \in \tilde{M}$ . Then

$$\tilde{T} = \Omega^{\mu\nu} \otimes e_{\mu\nu} \quad \text{and} \quad \tilde{R} = \omega^{\mu\nu} \otimes e_{\kappa\lambda} \otimes \Omega_{\mu\nu}^{\kappa\lambda},$$

i.e., for  $\forall X, Y \in \mathcal{X}(\tilde{M})$ ,

$$\tilde{T}(X, Y) = \Omega^{\mu\nu}(X, Y)e_{\mu\nu} \quad \text{and} \quad \tilde{R}(X, Y) = \Omega_{\mu\nu}^{\kappa\lambda}(X, Y)\omega^{\mu\nu} \otimes e_{\kappa\lambda}.$$

**Theorem 2.4** Let  $(\tilde{M}, \tilde{D})$  be a combinatorially connection space and  $\{e_{ij}\}$  a local frame with a dual  $\{\omega^{ij}\}$  at a point  $p \in \tilde{M}$ . Then

$$\tilde{d}\Omega^{\mu\nu} = \omega^{\kappa\lambda} \wedge \Omega_{\kappa\lambda}^{\mu\nu} - \Omega^{\kappa\lambda} \wedge \omega_{\kappa\lambda}^{\mu\nu} \quad \text{and} \quad \tilde{d}\Omega_{\mu\nu}^{\kappa\lambda} = \omega_{\mu\nu}^{\sigma\varsigma} \wedge \Omega_{\sigma\varsigma}^{\kappa\lambda} - \Omega_{\mu\nu}^{\sigma\varsigma} \wedge \omega_{\sigma\varsigma}^{\kappa\lambda}.$$

*Proof* Notice that  $\tilde{d}^2 = 0$ . Differentiating the equality  $\Omega^{\mu\nu} = \tilde{d}\omega^{\mu\nu} - \omega^{\mu\nu} \wedge \omega_{\kappa\lambda}^{\mu\nu}$  on both

sides, we get that

$$\begin{aligned}\tilde{d}\Omega^{\mu\nu} &= -\tilde{d}\omega^{\mu\nu} \wedge \omega_{\kappa\lambda}^{\mu\nu} + \omega^{\mu\nu} \wedge \tilde{d}\omega_{\kappa\lambda}^{\mu\nu} \\ &= -(\Omega^{\kappa\lambda} + \omega^{\sigma\varsigma} \wedge \omega_{\sigma\varsigma}^{\kappa\lambda}) \wedge \omega_{\kappa\lambda}^{\mu\nu} + \omega^{\kappa\lambda} \wedge (\Omega_{\kappa\lambda}^{\mu\nu} + \omega_{\kappa\lambda}^{\sigma\varsigma} \wedge \omega_{\sigma\varsigma}^{\mu\nu}) \\ &= \omega^{\kappa\lambda} \wedge \Omega_{\kappa\lambda}^{\mu\nu} - \Omega^{\kappa\lambda} \wedge \omega_{\kappa\lambda}^{\mu\nu}.\end{aligned}$$

Similarly, differentiating the equality  $\Omega_{\mu\nu}^{\kappa\lambda} = \tilde{d}\omega_{\mu\nu}^{\kappa\lambda} - \omega_{\mu\nu}^{\sigma\varsigma} \wedge \omega_{\sigma\varsigma}^{\kappa\lambda}$  on both sides, we can also find that

$$\tilde{d}\Omega_{\mu\nu}^{\kappa\lambda} = \omega_{\mu\nu}^{\sigma\varsigma} \wedge \Omega_{\sigma\varsigma}^{\kappa\lambda} - \Omega_{\mu\nu}^{\sigma\varsigma} \wedge \omega_{\sigma\varsigma}^{\kappa\lambda}. \quad \square$$

**Corollary 2.2** *Let  $(M, D)$  be an affine connection space and  $\{e_i\}$  a local frame with a dual  $\{\omega^i\}$  at a point  $p \in M$ . Then*

$$d\Omega^i = \omega^j \wedge \Omega_j^i - \Omega^j \wedge \omega_j^i \quad \text{and} \quad d\Omega_i^j = \omega_i^k \wedge \Omega_k^j - \Omega_i^k \wedge \omega_k^j.$$

According to Theorems 2.1 – 2.4 there is a type (1, 3) tensor

$$\tilde{\mathcal{R}}_p : T_p\tilde{M} \times T_p\tilde{M} \times T_p\tilde{M} \rightarrow T_p\tilde{M}$$

determined by  $\tilde{\mathcal{R}}(w, u, v) = \tilde{\mathcal{R}}(u, v)w$  for  $\forall u, v, w \in T_p\tilde{M}$  at each point  $p \in \tilde{M}$ . Particularly, we get its a concrete local form in the standard basis  $\{\frac{\partial}{\partial x^{\mu\nu}}\}$ .

**Theorem 2.5** *Let  $(\tilde{M}, \tilde{D})$  be a combinatorially connection space. Then for  $\forall p \in \tilde{M}$  with a local chart  $(U_p; [\varphi_p])$ ,*

$$\tilde{\mathcal{R}} = \tilde{\mathcal{R}}_{(\sigma\varsigma)(\mu\nu)(\kappa\lambda)}^{\eta\theta} dx^{\sigma\varsigma} \otimes \frac{\partial}{\partial x^{\eta\theta}} \otimes dx^{\mu\nu} \otimes dx^{\kappa\lambda}$$

with

$$\tilde{\mathcal{R}}_{(\sigma\varsigma)(\mu\nu)(\kappa\lambda)}^{\eta\theta} = \frac{\partial \Gamma_{(\sigma\varsigma)(\kappa\lambda)}^{\eta\theta}}{\partial x^{\mu\nu}} - \frac{\partial \Gamma_{(\sigma\varsigma)(\mu\nu)}^{\eta\theta}}{\partial x^{\kappa\lambda}} + \Gamma_{(\sigma\varsigma)(\kappa\lambda)}^{\vartheta\iota} \Gamma_{(\vartheta\iota)(\mu\nu)}^{\eta\theta} - \Gamma_{(\sigma\varsigma)(\mu\nu)}^{\vartheta\iota} \Gamma_{(\vartheta\iota)(\kappa\lambda)}^{\eta\theta} \frac{\partial}{\partial x^{\vartheta\iota}},$$

where,  $\Gamma_{(\mu\nu)(\kappa\lambda)}^{\sigma\varsigma} \in C^\infty(U_p)$  is determined by

$$\tilde{D}_{\frac{\partial}{\partial x^{\mu\nu}}} \frac{\partial}{\partial x^{\kappa\lambda}} = \Gamma_{(\kappa\lambda)(\mu\nu)}^{\sigma\varsigma} \frac{\partial}{\partial x^{\sigma\varsigma}}.$$

*Proof* We only need to prove that for integers  $\mu, \nu, \kappa, \lambda, \sigma, \varsigma, \iota$  and  $\theta$ ,

$$\tilde{\mathcal{R}}\left(\frac{\partial}{\partial x^{\mu\nu}}, \frac{\partial}{\partial x^{\kappa\lambda}}\right) \frac{\partial}{\partial x^{\sigma\varsigma}} = \tilde{\mathcal{R}}_{(\sigma\varsigma)(\mu\nu)(\kappa\lambda)}^{\eta\theta} \frac{\partial}{\partial x^{\eta\theta}}$$

at the local chart  $(U_p; [\varphi_p])$ . In fact, by definition we get that

$$\begin{aligned}
& \tilde{\mathcal{R}}\left(\frac{\partial}{\partial x^{\mu\nu}}, \frac{\partial}{\partial x^{\kappa\lambda}}\right) \frac{\partial}{\partial x^{\sigma\varsigma}} \\
&= \tilde{D}_{\frac{\partial}{\partial x^{\mu\nu}}} \tilde{D}_{\frac{\partial}{\partial x^{\kappa\lambda}}} \frac{\partial}{\partial x^{\sigma\varsigma}} - \tilde{D}_{\frac{\partial}{\partial x^{\kappa\lambda}}} \tilde{D}_{\frac{\partial}{\partial x^{\mu\nu}}} \frac{\partial}{\partial x^{\sigma\varsigma}} - \tilde{D}_{[\frac{\partial}{\partial x^{\mu\nu}}, \frac{\partial}{\partial x^{\kappa\lambda}}]} \frac{\partial}{\partial x^{\sigma\varsigma}} \\
&= \tilde{D}_{\frac{\partial}{\partial x^{\mu\nu}}} (\Gamma_{(\sigma\varsigma)(\kappa\lambda)}^{\eta\theta} \frac{\partial}{\partial x^{\eta\theta}}) - \tilde{D}_{\frac{\partial}{\partial x^{\kappa\lambda}}} (\Gamma_{(\sigma\varsigma)(\mu\nu)}^{\eta\theta} \frac{\partial}{\partial x^{\eta\theta}}) \\
&= \frac{\partial \Gamma_{(\sigma\varsigma)(\kappa\lambda)}^{\eta\theta}}{\partial x^{\mu\nu}} \frac{\partial}{\partial x^{\eta\theta}} + \Gamma_{(\sigma\varsigma)(\kappa\lambda)}^{\eta\theta} \tilde{D}_{\frac{\partial}{\partial x^{\mu\nu}}} \frac{\partial}{\partial x^{\eta\theta}} - \frac{\partial \Gamma_{(\sigma\varsigma)(\mu\nu)}^{\eta\theta}}{\partial x^{\kappa\lambda}} \frac{\partial}{\partial x^{\eta\theta}} - \Gamma_{(\sigma\varsigma)(\mu\nu)}^{\eta\theta} \tilde{D}_{\frac{\partial}{\partial x^{\kappa\lambda}}} \frac{\partial}{\partial x^{\eta\theta}} \\
&= \left( \frac{\partial \Gamma_{(\sigma\varsigma)(\kappa\lambda)}^{\eta\theta}}{\partial x^{\mu\nu}} - \frac{\partial \Gamma_{(\sigma\varsigma)(\mu\nu)}^{\eta\theta}}{\partial x^{\kappa\lambda}} \right) \frac{\partial}{\partial x^{\eta\theta}} + \Gamma_{(\sigma\varsigma)(\kappa\lambda)}^{\eta\theta} \Gamma_{(\eta\theta)(\mu\nu)}^{\vartheta\iota} \frac{\partial}{\partial x^{\vartheta\iota}} - \Gamma_{(\sigma\varsigma)(\mu\nu)}^{\eta\theta} \Gamma_{(\eta\theta)(\kappa\lambda)}^{\vartheta\iota} \frac{\partial}{\partial x^{\vartheta\iota}} \\
&= \left( \frac{\partial \Gamma_{(\sigma\varsigma)(\kappa\lambda)}^{\eta\theta}}{\partial x^{\mu\nu}} - \frac{\partial \Gamma_{(\sigma\varsigma)(\mu\nu)}^{\eta\theta}}{\partial x^{\kappa\lambda}} + \Gamma_{(\sigma\varsigma)(\kappa\lambda)}^{\vartheta\iota} \Gamma_{(\vartheta\iota)(\mu\nu)}^{\eta\theta} - \Gamma_{(\sigma\varsigma)(\mu\nu)}^{\vartheta\iota} \Gamma_{(\vartheta\iota)(\kappa\lambda)}^{\eta\theta} \right) \frac{\partial}{\partial x^{\vartheta\iota}} \\
&= \tilde{\mathcal{R}}_{(\sigma\varsigma)(\mu\nu)(\kappa\lambda)}^{\eta\theta} \frac{\partial}{\partial x^{\eta\theta}}.
\end{aligned}$$

This completes the proof.  $\square$

For the curvature tensor  $\tilde{\mathcal{R}}_{(\sigma\varsigma)(\mu\nu)(\kappa\lambda)}^{\eta\theta}$ , we can also get these *Bianchi identities* in the next result.

**Theorem 2.6** *Let  $(\tilde{M}, \tilde{D})$  be a combinatorially connection space. Then for  $\forall p \in \tilde{M}$  with a local chart  $(U_p, [\varphi_p])$ , if  $\tilde{T} \equiv 0$ , then*

$$\tilde{R}_{(\kappa\lambda)(\sigma\varsigma)(\eta\theta)}^{\mu\nu} + \tilde{R}_{(\sigma\varsigma)(\eta\theta)(\kappa\lambda)}^{\mu\nu} + \tilde{R}_{(\eta\theta)(\kappa\lambda)(\sigma\varsigma)}^{\mu\nu} = 0$$

and

$$\tilde{D}_{\vartheta\iota} \tilde{R}_{(\mu\nu)(\sigma\varsigma)(\eta\theta)}^{\kappa\lambda} + \tilde{D}_{\sigma\varsigma} \tilde{R}_{(\mu\nu)(\eta\theta)(\vartheta\iota)}^{\kappa\lambda} + \tilde{D}_{\eta\theta} \tilde{R}_{(\mu\nu)(\vartheta\iota)(\sigma\varsigma)}^{\kappa\lambda} = 0,$$

where,

$$\tilde{D}_{\vartheta\iota} \tilde{R}_{(\mu\nu)(\sigma\varsigma)(\eta\theta)}^{\kappa\lambda} = \tilde{D}_{\frac{\partial}{\partial x^{\vartheta\iota}}} \tilde{R}_{(\mu\nu)(\sigma\varsigma)(\eta\theta)}^{\kappa\lambda}.$$

*Proof* By definition of the curvature tensor  $\tilde{\mathcal{R}}_{(\sigma\varsigma)(\mu\nu)(\kappa\lambda)}^{\eta\theta}$ , we know that

$$\begin{aligned}
& \tilde{R}_{(\kappa\lambda)(\sigma\varsigma)(\eta\theta)}^{\mu\nu} + \tilde{R}_{(\sigma\varsigma)(\eta\theta)(\kappa\lambda)}^{\mu\nu} + \tilde{R}_{(\eta\theta)(\kappa\lambda)(\sigma\varsigma)}^{\mu\nu} \\
&= \tilde{R}\left(\frac{\partial}{\partial x^{\sigma\varsigma}}, \frac{\partial}{\partial x^{\eta\theta}}\right) \frac{\partial}{\partial x^{\kappa\lambda}} + \tilde{R}\left(\frac{\partial}{\partial x^{\eta\theta}}, \frac{\partial}{\partial x^{\kappa\lambda}}\right) \frac{\partial}{\partial x^{\sigma\varsigma}} + \tilde{R}\left(\frac{\partial}{\partial x^{\kappa\lambda}}, \frac{\partial}{\partial x^{\sigma\varsigma}}\right) \frac{\partial}{\partial x^{\eta\theta}} \\
&= 0
\end{aligned}$$

with

$$X = \frac{\partial}{\partial x^{\sigma\varsigma}}, \quad Y = \frac{\partial}{\partial x^{\eta\theta}} \quad \text{and} \quad Z = \frac{\partial}{\partial x^{\kappa\lambda}}. \quad \natural$$

in the first Bianchi equality and

$$\begin{aligned} & \tilde{D}_{\vartheta\iota}\tilde{R}_{(\mu\nu)(\sigma\varsigma)(\eta\theta)}^{\kappa\lambda} + \tilde{D}_{\sigma\varsigma}\tilde{R}_{(\mu\nu)(\eta\theta)(\vartheta\iota)}^{\kappa\lambda} + \tilde{D}_{\eta\theta}\tilde{R}_{(\mu\nu)(\vartheta\iota)(\sigma\varsigma)}^{\kappa\lambda} \\ &= \tilde{D}_{\vartheta\iota}\tilde{R}\left(\frac{\partial}{\partial x^{\sigma\varsigma}}, \frac{\partial}{\partial x^{\eta\theta}}\right)\frac{\partial}{\partial x^{\kappa\lambda}} + \tilde{D}_{\sigma\varsigma}\tilde{R}\left(\frac{\partial}{\partial x^{\eta\theta}}, \frac{\partial}{\partial x^{\vartheta\iota}}\right)\frac{\partial}{\partial x^{\kappa\lambda}} + \tilde{D}_{\eta\theta}\tilde{R}\left(\frac{\partial}{\partial x^{\vartheta\iota}}, \frac{\partial}{\partial x^{\sigma\varsigma}}\right)\frac{\partial}{\partial x^{\kappa\lambda}} \\ &= 0. \end{aligned}$$

with

$$X = \frac{\partial}{\partial x^{\vartheta\iota}}, Y = \frac{\partial}{\partial x^{\sigma\varsigma}}, Z = \frac{\partial}{\partial x^{\eta\theta}}, W = \frac{\partial}{\partial x^{\kappa\lambda}}$$

in the second Bianchi equality of Theorem 2.2.  $\square$

### §3. Curvatures on Combinatorially Riemannian Manifolds

Now we turn our attention to combinatorially Riemannian manifolds and characterize curvature tensors on combinatorial manifolds further.

**Definition 3.1** Let  $(\tilde{M}, g, \tilde{D})$  be a combinatorially Riemannian manifold. A combinatorially Riemannian curvature tensor

$$\tilde{R} : \mathcal{X}(\tilde{M}) \times \mathcal{X}(\tilde{M}) \times \mathcal{X}(\tilde{M}) \times \mathcal{X}(\tilde{M}) \rightarrow C^\infty(\tilde{M})$$

of type  $(0, 4)$  is defined by

$$\tilde{R}(X, Y, Z, W) = g(\tilde{R}(Z, W)X, Y)$$

for  $\forall X, Y, Z, W \in \mathcal{X}(\tilde{M})$ .

Then we find symmetrical relations of  $\tilde{R}(X, Y, Z, W)$  following.

**Theorem 3.1** Let  $\tilde{R} : \mathcal{X}(\tilde{M}) \times \mathcal{X}(\tilde{M}) \times \mathcal{X}(\tilde{M}) \times \mathcal{X}(\tilde{M}) \rightarrow C^\infty(\tilde{M})$  be a combinatorially Riemannian curvature tensor. Then for  $\forall X, Y, Z, W \in \mathcal{X}(\tilde{M})$ ,

- (1)  $\tilde{R}(X, Y, Z, W) + \tilde{R}(Z, Y, W, X) + \tilde{R}(W, Y, X, Z) = 0$ .
- (2)  $\tilde{R}(X, Y, Z, W) = -\tilde{R}(Y, X, Z, W)$  and  $\tilde{R}(X, Y, Z, W) = -\tilde{R}(X, Y, W, Z)$ .
- (3)  $\tilde{R}(X, Y, Z, W) = \tilde{R}(Z, W, X, Y)$ .

*Proof* For the equality (1), calculation shows that

$$\begin{aligned} & \tilde{R}(X, Y, Z, W) + \tilde{R}(Z, Y, W, X) + \tilde{R}(W, Y, X, Z) \\ &= g(\tilde{R}(Z, W)X, Y) + g(\tilde{R}(W, X)Z, Y) + g(\tilde{R}(X, Z)W, Y) \\ &= g(\tilde{R}(Z, W)X + \tilde{R}(W, X)Z + \tilde{R}(X, Z)W, Y) = 0 \end{aligned}$$

by definition and Theorem 2.1(4).

For (2), by definition and Theorem 2.1(1), we know that

$$\begin{aligned}\tilde{R}(X, Y, Z, W) &= g(\tilde{R}(Z, W)X, Y) = g(-\tilde{R}(W, Z)X, Y) \\ &= -g(\tilde{R}(W, Z)X, Y) = -\tilde{R}(X, Y, W, Z).\end{aligned}$$

Now since  $\tilde{D}$  is a combinatorially Riemannian connection, we know that ([9])

$$Z(g(X, Y)) = g(\tilde{D}_Z X, Y) + g(X, \tilde{D}_Z Y).$$

Therefore, we find that

$$\begin{aligned}g(\tilde{D}_Z \tilde{D}_W X, Y) &= Z(g(\tilde{D}_W X, Y)) - g(\tilde{D}_W X, \tilde{D}_Z Y) \\ &= Z(W(g(X, Y))) - Z(g(X, \tilde{D}_W Y)) \\ &\quad - W(g(X, \tilde{D}_Z Y)) + g(X, \tilde{D}_W \tilde{D}_Z Y).\end{aligned}$$

Similarly, we have that

$$\begin{aligned}g(\tilde{D}_W \tilde{D}_Z X, Y) &= W(Z(g(X, Y))) - W(g(X, \tilde{D}_Z Y)) \\ &\quad - Z(g(X, \tilde{D}_W Y)) + g(X, \tilde{D}_Z \tilde{D}_W Y).\end{aligned}$$

Notice that

$$g(\tilde{D}_{[Z, W]} Y) = [Z, W]g(X, Y) - g(X, \tilde{D}_{[Z, W]} Y).$$

By definition, we get that

$$\begin{aligned}\tilde{R}(X, Y, Z, W) &= g(\tilde{D}_Z \tilde{D}_W X - \tilde{D}_W \tilde{D}_Z X - \tilde{D}_{[Z, W]} X, Y) \\ &= g(\tilde{D}_Z \tilde{D}_W X, Y) - g(\tilde{D}_W \tilde{D}_Z X, Y) - g(\tilde{D}_{[Z, W]} X, Y) \\ &= Z(W(g(X, Y))) - Z(g(X, \tilde{D}_W Y)) - W(g(X, \tilde{D}_Z Y)) \\ &\quad + g(X, \tilde{D}_W \tilde{D}_Z Y) - W(Z(g(X, Y))) + W(g(X, \tilde{D}_Z Y)) \\ &\quad + Z(g(X, \tilde{D}_W Y)) - g(X, \tilde{D}_Z \tilde{D}_W Y) - [Z, W]g(X, Y) \\ &\quad - g(X, \tilde{D}_{[Z, W]} Y) \\ &= Z(W(g(X, Y))) - W(Z(g(X, Y))) + g(X, \tilde{D}_W \tilde{D}_Z Y) \\ &\quad - g(X, \tilde{D}_Z \tilde{D}_W Y) - [Z, W]g(X, Y) - g(X, \tilde{D}_{[Z, W]} Y) \\ &= g(X, \tilde{D}_W \tilde{D}_Z Y - \tilde{D}_Z \tilde{D}_W Y + \tilde{D}_{[Z, W]} Y) \\ &= -g(X, \tilde{R}(Z, W)Y) = -\tilde{R}(Y, X, Z, W).\end{aligned}$$

Applying the equality (1), we know that

$$\tilde{R}(X, Y, Z, W) + \tilde{R}(Z, Y, W, X) + \tilde{R}(W, Y, X, Z) = 0, \quad (3.1)$$

$$\tilde{R}(Y, Z, W, X) + \tilde{R}(W, Z, X, Y) + \tilde{R}(X, Z, Y, W) = 0. \quad (3.2)$$



Then (3.1) + (3.2) shows that

$$\begin{aligned} \tilde{R}(X, Y, Z, W) &+ \tilde{R}(W, Y, X, Z) \\ &+ \tilde{R}(W, Z, X, Y) + \tilde{R}(X, Z, Y, W) = 0 \end{aligned}$$

by applying (2). We also know that

$$\begin{aligned} \tilde{R}(W, Y, X, Z) - \tilde{R}(X, Z, Y, W) &= -(\tilde{R}(Z, Y, W, X) - \tilde{R}(W, X, Z, Y)) \\ &= \tilde{R}(X, Y, Z, W) - \tilde{R}(Z, W, X, Y). \end{aligned}$$

This enables us getting the equality (3)

$$\tilde{R}(X, Y, Z, W) = \tilde{R}(Z, W, X, Y). \quad \square$$

Applying Theorems 2.2, 2.3 and 3.1, we also get the next result.

**Theorem 3.2** *Let  $(\tilde{M}, g, \tilde{D})$  be a combinatorially Riemannian manifold and  $\Omega_{(\mu\nu)(\kappa\lambda)} = \Omega_{\mu\nu}^{\sigma\varsigma} g_{(\sigma\varsigma)(\kappa\lambda)}$ . Then*

- (1)  $\Omega_{(\mu\nu)(\kappa\lambda)} = \frac{1}{2} \tilde{R}_{(\mu\nu)(\kappa\lambda)(\sigma\varsigma)(\eta\theta)} \omega^{\sigma\varsigma} \wedge \omega^{\eta\theta}$ ;
- (2)  $\Omega_{(\mu\nu)(\kappa\lambda)} + \Omega_{(\kappa\lambda)(\mu\nu)} = 0$ ;
- (3)  $\omega^{\mu\nu} \wedge \Omega_{(\mu\nu)(\kappa\lambda)} = 0$ ;
- (4)  $\tilde{d}\Omega_{(\mu\nu)(\kappa\lambda)} = \omega_{\mu\nu}^{\sigma\varsigma} \wedge \Omega_{(\sigma\varsigma)(\kappa\lambda)} - \omega_{\kappa\lambda}^{\sigma\varsigma} \wedge \Omega_{(\sigma\varsigma)(\mu\nu)}$ .

*Proof* Notice that  $\tilde{T} \equiv 0$  in a combinatorially Riemannian manifold  $(\tilde{M}, g, \tilde{D})$ . We find that

$$\Omega_{\mu\nu}^{\kappa\lambda} = \frac{1}{2} \tilde{R}_{(\mu\nu)(\sigma\varsigma)(\eta\theta)}^{\kappa\lambda} \omega^{\sigma\varsigma} \wedge \omega^{\eta\theta}$$

by Theorem 2.2. By definition, we know that

$$\begin{aligned} \Omega_{(\mu\nu)(\kappa\lambda)} &= \Omega_{\mu\nu}^{\sigma\varsigma} g_{(\sigma\varsigma)(\kappa\lambda)} \\ &= \frac{1}{2} \tilde{R}_{(\mu\nu)(\eta\theta)(\vartheta\iota)}^{\sigma\varsigma} g_{(\sigma\varsigma)(\kappa\lambda)} \omega^{\eta\theta} \wedge \omega^{\vartheta\iota} = \frac{1}{2} \tilde{R}_{(\mu\nu)(\kappa\lambda)(\sigma\varsigma)(\eta\theta)} \omega^{\sigma\varsigma} \wedge \omega^{\eta\theta}. \end{aligned}$$

Whence, we get the equality (1). For (2), applying Theorem 3.1(2), we find that

$$\Omega_{(\mu\nu)(\kappa\lambda)} + \Omega_{(\kappa\lambda)(\mu\nu)} = \frac{1}{2} (\tilde{R}_{(\mu\nu)(\kappa\lambda)(\sigma\varsigma)(\eta\theta)} + \tilde{R}_{(\kappa\lambda)(\mu\nu)(\sigma\varsigma)(\eta\theta)}) \omega^{\sigma\varsigma} \wedge \omega^{\eta\theta} = 0.$$

By Corollary 2.1, a connection  $\tilde{D}$  is torsion-free only if  $\Omega^{\mu\nu} \equiv 0$ . This fact enables us to get these equalities (3) and (4) by Theorem 2.3.  $\square$

For any point  $p \in \tilde{M}$  with a local chart  $(U_p, [\varphi_p])$ , we can also find a local form of  $\tilde{R}$  in the next result.

**Theorem 3.3** *Let  $\tilde{R} : \mathcal{X}(\tilde{M}) \times \mathcal{X}(\tilde{M}) \times \mathcal{X}(\tilde{M}) \times \mathcal{X}(\tilde{M}) \rightarrow C^\infty(\tilde{M})$  be a combinatorially*

Riemannian curvature tensor. Then for  $\forall p \in \widetilde{M}$  with a local chart  $(U_p; [\varphi_p])$ ,

$$\widetilde{R} = \widetilde{R}_{(\sigma\varsigma)(\eta\theta)(\mu\nu)(\kappa\lambda)} dx^{\sigma\varsigma} \otimes dx^{\eta\theta} \otimes dx^{\mu\nu} \otimes dx^{\kappa\lambda}$$

with

$$\begin{aligned} \widetilde{R}_{(\sigma\varsigma)(\eta\theta)(\mu\nu)(\kappa\lambda)} &= \frac{1}{2} \left( \frac{\partial^2 g_{(\mu\nu)(\sigma\varsigma)}}{\partial x^{\kappa\lambda} \partial x^{\eta\theta}} + \frac{\partial^2 g_{(\kappa\lambda)(\eta\theta)}}{\partial x^{\mu\nu} \partial x^{\sigma\varsigma}} - \frac{\partial^2 g_{(\mu\nu)(\eta\theta)}}{\partial x^{\kappa\lambda} \partial x^{\sigma\varsigma}} - \frac{\partial^2 g_{(\kappa\lambda)(\sigma\varsigma)}}{\partial x^{\mu\nu} \partial x^{\eta\theta}} \right) \\ &+ \Gamma_{(\mu\nu)(\sigma\varsigma)}^{\vartheta\iota} \Gamma_{(\kappa\lambda)(\eta\theta)}^{\xi\omicron} g_{(\xi\omicron)(\vartheta\iota)} - \Gamma_{(\mu\nu)(\eta\theta)}^{\xi\omicron} \Gamma_{(\kappa\lambda)(\sigma\varsigma)}^{\vartheta\iota} g_{(\xi\omicron)(\vartheta\iota)}, \end{aligned}$$

where  $g_{(\mu\nu)(\kappa\lambda)} = g\left(\frac{\partial}{\partial x^{\mu\nu}}, \frac{\partial}{\partial x^{\kappa\lambda}}\right)$ .

*Proof* Notice that

$$\begin{aligned} \widetilde{R}_{(\sigma\varsigma)(\eta\theta)(\mu\nu)(\kappa\lambda)} &= \widetilde{R}\left(\frac{\partial}{\partial x^{\sigma\varsigma}}, \frac{\partial}{\partial x^{\eta\theta}}, \frac{\partial}{\partial x^{\mu\nu}}, \frac{\partial}{\partial x^{\kappa\lambda}}\right) = \widetilde{R}\left(\frac{\partial}{\partial x^{\mu\nu}}, \frac{\partial}{\partial x^{\kappa\lambda}}, \frac{\partial}{\partial x^{\sigma\varsigma}}, \frac{\partial}{\partial x^{\eta\theta}}\right) \\ &= g\left(\widetilde{R}\left(\frac{\partial}{\partial x^{\sigma\varsigma}}, \frac{\partial}{\partial x^{\eta\theta}}\right) \frac{\partial}{\partial x^{\mu\nu}}, \frac{\partial}{\partial x^{\kappa\lambda}}\right) = \widetilde{R}_{(\mu\nu)(\sigma\varsigma)(\eta\theta)}^{\vartheta\iota} g_{(\vartheta\iota)(\kappa\lambda)} \end{aligned}$$

By definition and Theorem 3.1(3). Now we have know that (eqn.(3.5) in [9])

$$\frac{\partial g_{(\mu\nu)(\kappa\lambda)}}{\partial x^{\sigma\varsigma}} = \Gamma_{(\mu\nu)(\sigma\varsigma)}^{\eta\theta} g_{(\eta\theta)(\kappa\lambda)} + \Gamma_{(\kappa\lambda)(\sigma\varsigma)}^{\eta\theta} g_{(\mu\nu)(\eta\theta)}.$$

Applying Theorem 2.4, we get that

$$\begin{aligned} &\widetilde{R}_{(\sigma\varsigma)(\eta\theta)(\mu\nu)(\kappa\lambda)} \\ &= \left( \frac{\partial \Gamma_{(\sigma\varsigma)(\kappa\lambda)}^{\vartheta\iota}}{\partial x^{\mu\nu}} - \frac{\partial \Gamma_{(\sigma\varsigma)(\mu\nu)}^{\vartheta\iota}}{\partial x^{\kappa\lambda}} + \Gamma_{(\sigma\varsigma)(\kappa\lambda)}^{\xi\omicron} \Gamma_{(\xi\omicron)(\mu\nu)}^{\vartheta\iota} - \Gamma_{(\sigma\varsigma)(\mu\nu)}^{\xi\omicron} \Gamma_{(\xi\omicron)(\kappa\lambda)}^{\vartheta\iota} \right) g_{(\vartheta\iota)(\eta\theta)} \\ &= \frac{\partial}{\partial x^{\mu\nu}} \left( \Gamma_{(\sigma\varsigma)(\kappa\lambda)}^{\vartheta\iota} g_{(\vartheta\iota)(\eta\theta)} \right) - \Gamma_{(\sigma\varsigma)(\kappa\lambda)}^{\vartheta\iota} \frac{\partial g_{(\vartheta\iota)(\eta\theta)}}{\partial x^{\mu\nu}} - \frac{\partial}{\partial x^{\kappa\lambda}} \left( \Gamma_{(\sigma\varsigma)(\mu\nu)}^{\vartheta\iota} g_{(\vartheta\iota)(\eta\theta)} \right) \\ &+ \Gamma_{(\sigma\varsigma)(\mu\nu)}^{\vartheta\iota} \frac{\partial g_{(\vartheta\iota)(\eta\theta)}}{\partial x^{\kappa\lambda}} + \Gamma_{(\sigma\varsigma)(\kappa\lambda)}^{\xi\omicron} \Gamma_{(\xi\omicron)(\mu\nu)}^{\vartheta\iota} g_{(\vartheta\iota)(\kappa\lambda)} - \Gamma_{(\sigma\varsigma)(\mu\nu)}^{\xi\omicron} \Gamma_{(\xi\omicron)(\kappa\lambda)}^{\vartheta\iota} g_{(\vartheta\iota)(\eta\theta)} \\ &= \frac{\partial}{\partial x^{\mu\nu}} \left( \Gamma_{(\sigma\varsigma)(\kappa\lambda)}^{\vartheta\iota} g_{(\vartheta\iota)(\eta\theta)} \right) - \frac{\partial}{\partial x^{\kappa\lambda}} \left( \Gamma_{(\sigma\varsigma)(\mu\nu)}^{\vartheta\iota} g_{(\vartheta\iota)(\eta\theta)} \right) \\ &+ \Gamma_{(\sigma\varsigma)(\mu\nu)}^{\vartheta\iota} \left( \Gamma_{(\vartheta\iota)(\kappa\lambda)}^{\xi\omicron} g_{(\xi\omicron)(\eta\theta)} + \Gamma_{(\eta\theta)(\kappa\lambda)}^{\xi\omicron} g_{(\vartheta\iota)(\xi\omicron)} \right) + \Gamma_{(\sigma\varsigma)(\kappa\lambda)}^{\xi\omicron} \Gamma_{(\xi\omicron)(\mu\nu)}^{\vartheta\iota} g_{(\vartheta\iota)(\kappa\lambda)} \\ &- \Gamma_{(\sigma\varsigma)(\kappa\lambda)}^{\vartheta\iota} \left( \Gamma_{(\vartheta\iota)(\mu\nu)}^{\xi\omicron} g_{(\xi\omicron)(\eta\theta)} + \Gamma_{(\eta\theta)(\mu\nu)}^{\xi\omicron} g_{(\vartheta\iota)(\xi\omicron)} \right) - \Gamma_{(\sigma\varsigma)(\mu\nu)}^{\xi\omicron} \Gamma_{(\xi\omicron)(\kappa\lambda)}^{\vartheta\iota} g_{(\vartheta\iota)(\eta\theta)} \\ &= \frac{1}{2} \frac{\partial}{\partial x^{\mu\nu}} \left( \frac{\partial g_{(\sigma\varsigma)(\eta\theta)}}{\partial x^{\kappa\lambda}} + \frac{\partial g_{(\kappa\lambda)(\eta\theta)}}{\partial x^{\sigma\varsigma}} - \frac{\partial g_{(\sigma\varsigma)(\kappa\lambda)}}{\partial x^{\eta\theta}} \right) + \Gamma_{(\sigma\varsigma)(\kappa\lambda)}^{\xi\omicron} \Gamma_{(\xi\omicron)(\mu\nu)}^{\vartheta\iota} g_{(\vartheta\iota)(\kappa\lambda)} \\ &- \frac{1}{2} \frac{\partial}{\partial x^{\kappa\lambda}} \left( \frac{\partial g_{(\sigma\varsigma)(\eta\theta)}}{\partial x^{\mu\nu}} + \frac{\partial g_{(\mu\nu)(\eta\theta)}}{\partial x^{\sigma\varsigma}} - \frac{\partial g_{(\sigma\varsigma)(\mu\nu)}}{\partial x^{\eta\theta}} \right) - \Gamma_{(\sigma\varsigma)(\mu\nu)}^{\xi\omicron} \Gamma_{(\xi\omicron)(\kappa\lambda)}^{\vartheta\iota} g_{(\vartheta\iota)(\eta\theta)} \\ &= \frac{1}{2} \left( \frac{\partial^2 g_{(\mu\nu)(\sigma\varsigma)}}{\partial x^{\kappa\lambda} \partial x^{\eta\theta}} + \frac{\partial^2 g_{(\kappa\lambda)(\eta\theta)}}{\partial x^{\mu\nu} \partial x^{\sigma\varsigma}} - \frac{\partial^2 g_{(\mu\nu)(\eta\theta)}}{\partial x^{\kappa\lambda} \partial x^{\sigma\varsigma}} - \frac{\partial^2 g_{(\kappa\lambda)(\sigma\varsigma)}}{\partial x^{\mu\nu} \partial x^{\eta\theta}} \right) \\ &+ \Gamma_{(\sigma\varsigma)(\kappa\lambda)}^{\xi\omicron} \Gamma_{(\xi\omicron)(\mu\nu)}^{\vartheta\iota} g_{(\vartheta\iota)(\kappa\lambda)} - \Gamma_{(\sigma\varsigma)(\mu\nu)}^{\xi\omicron} \Gamma_{(\xi\omicron)(\kappa\lambda)}^{\vartheta\iota} g_{(\vartheta\iota)(\eta\theta)}. \end{aligned}$$

This completes the proof.  $\square$

Combining Theorems 2.5, 3.1 and 3.3, we have the following consequence.

**Corollary 3.1** Let  $\tilde{R}_{(\mu\nu)(\kappa\lambda)(\sigma\varsigma)(\eta\theta)}$  be a component of a combinatorially Riemannian curvature tensor  $\tilde{R}$  in a local chart  $(U, [\varphi])$  of a combinatorially Riemannian manifold  $(\tilde{R}, g, \tilde{D})$ . Then

- (1)  $\tilde{R}_{(\mu\nu)(\kappa\lambda)(\sigma\varsigma)(\eta\theta)} = -\tilde{R}_{(\kappa\lambda)(\mu\nu)(\sigma\varsigma)(\eta\theta)} = -\tilde{R}_{(\mu\nu)(\kappa\lambda)(\eta\theta)(\sigma\varsigma)}$ ;
- (2)  $\tilde{R}_{(\mu\nu)(\kappa\lambda)(\sigma\varsigma)(\eta\theta)} = \tilde{R}_{(\sigma\varsigma)(\eta\theta)(\mu\nu)(\kappa\lambda)}$ ;
- (3)  $\tilde{R}_{(\mu\nu)(\kappa\lambda)(\sigma\varsigma)(\eta\theta)} + \tilde{R}_{(\eta\theta)(\kappa\lambda)(\mu\nu)(\sigma\varsigma)} + \tilde{R}_{(\sigma\varsigma)(\kappa\lambda)(\eta\theta)(\mu\nu)} = 0$ ;
- (4)  $\tilde{D}_{\vartheta\iota}\tilde{R}_{(\mu\nu)(\kappa\lambda)(\sigma\varsigma)(\eta\theta)} + \tilde{D}_{\sigma\varsigma}\tilde{R}_{(\mu\nu)(\kappa\lambda)(\eta\theta)(\vartheta\iota)} + \tilde{D}_{\eta\theta}\tilde{R}_{(\mu\nu)(\kappa\lambda)(\vartheta\iota)(\sigma\varsigma)} = 0$ .

#### §4. Einstein's Gravitational Equations on Combinatorial Manifolds

Application of results in last two sections enables us to establish these Einstein' gravitational filed equations on combinatorially Riemannian manifolds in this section and find their multi-space solutions in next section under a *projective principle* on the behavior of particles in multi-spaces.

Let  $(\tilde{M}, g, \tilde{D})$  be a combinatorially Riemannian manifold. A type  $(0, 2)$  tensor  $\mathcal{E} : \mathcal{X}(\tilde{M}) \times \mathcal{X}(\tilde{M}) \rightarrow C^\infty(\tilde{M})$  with

$$\mathcal{E} = \mathcal{E}_{(\mu\nu)(\kappa\lambda)} dx^{\mu\nu} \otimes dx^{\kappa\lambda} \quad (4.1)$$

is called an *energy-momentum tensor* if it satisfies the conservation laws  $\tilde{D}(\mathcal{E}) = 0$ , i.e., for any indexes  $\kappa, \lambda, 1 \leq \kappa \leq m, 1 \leq \lambda \leq n_\kappa$ ,

$$\frac{\partial \mathcal{E}_{(\mu\nu)(\kappa\lambda)}}{\partial x^{\kappa\lambda}} - \Gamma_{(\mu\nu)(\kappa\lambda)}^{\sigma\varsigma} \mathcal{E}_{(\sigma\varsigma)(\kappa\lambda)} - \Gamma_{(\kappa\lambda)(\kappa\lambda)}^{\sigma\varsigma} \mathcal{E}_{(\mu\nu)(\sigma\varsigma)} = 0 \quad (4.2)$$

in a local chart  $(U_p, [\varphi_p])$  for any point  $p \in \tilde{M}$ . Define the *Ricci tensor*  $\tilde{R}_{(\mu\nu)(\kappa\lambda)}$ , *Rocci scalar tensor*  $\mathbf{R}$  and *Einstein tensor*  $\mathcal{G}_{(\mu\nu)(\kappa\lambda)}$  respectively by

$$\tilde{R}_{(\mu\nu)(\kappa\lambda)} = \tilde{R}_{(\mu\nu)(\sigma\varsigma)(\kappa\lambda)}, \quad \mathbf{R} = g^{(\mu\nu)(\kappa\lambda)} \tilde{R}_{(\mu\nu)(\kappa\lambda)} \quad (4.3)$$

and

$$\mathcal{G}_{(\mu\nu)(\kappa\lambda)} = \tilde{R}_{(\mu\nu)(\kappa\lambda)} - \frac{1}{2} g_{(\mu\nu)(\kappa\lambda)} \mathbf{R}. \quad (4.4)$$

Then we get results following hold by Theorems 2.4, 2.5 and 3.1.

$$\tilde{R}_{(\mu\nu)(\kappa\lambda)} = \tilde{R}_{(\kappa\lambda)(\mu\nu)}, \quad (4.5)$$

$$\tilde{R}_{(\mu\nu)(\kappa\lambda)} = \frac{\partial \Gamma_{(\mu\nu)(\kappa\lambda)}^{\sigma\varsigma}}{\partial x^{\sigma\varsigma}} - \frac{\partial \Gamma_{(\mu\nu)(\sigma\varsigma)}^{\sigma\varsigma}}{\partial x^{\kappa\lambda}} + \Gamma_{(\mu\nu)(\kappa\lambda)}^{\vartheta\iota} \Gamma_{(\vartheta\iota)(\sigma\varsigma)}^{\sigma\varsigma} - \Gamma_{(\mu\nu)(\sigma\varsigma)}^{\vartheta\iota} \Gamma_{(\vartheta\iota)(\kappa\lambda)}^{\sigma\varsigma}. \quad (4.6)$$

and

$$\frac{\partial \mathcal{G}_{(\mu\nu)(\kappa\lambda)}}{\partial x^{\kappa\lambda}} - \Gamma_{(\mu\nu)(\kappa\lambda)}^{\sigma\varsigma} \mathcal{G}_{(\sigma\varsigma)(\kappa\lambda)} - \Gamma_{(\kappa\lambda)(\kappa\lambda)}^{\sigma\varsigma} \mathcal{G}_{(\mu\nu)(\sigma\varsigma)} = 0. \quad (4.7)$$

i.e.,  $\tilde{D}(\mathcal{G}) = 0$ . *Einstein's* principle of general relativity says that *a law of physics should take a same form in any reference system*, which claims that a right form for a physics law should be presented by tensors in mathematics. For a multi-spacetime, we conclude that *Einstein's*

principle of general relativity is still true, if we take the multi-spacetime being a combinatorially Riemannian manifold. Whence, a physics law should be also presented by tensor equations in the multi-spacetime case.

Just as the establishing of *Einstein's* gravitational equations in the classical case, these equations should satisfy two conditions following.

(C1) *They should be (0, 2) type tensor equations related to the energy-momentum tensor  $\mathcal{E}$  linearly;*

(C2) *Their forms should be the same as in a classical gravitational field.*

By these two conditions, *Einstein's* gravitational equations in a multi-spacetime should be taken the following form

$$\mathcal{G} = c\mathcal{E}$$

with  $c$  a constant. Now since these equations should take the same form in the classical case, i.e.,

$$\mathcal{G}_{ij} = -8\pi G\mathcal{E}_{ij}$$

for  $1 \leq i, j \leq n$  at a point  $p$  in a manifold of  $\widetilde{M}$  not contained in the others. Whence, it must be  $c = -8\pi G$  for  $c$  being a constant. This enables us finding these *Einstein's* gravitational equations in a multi-spacetime to be

$$\widetilde{\mathcal{R}}_{(\mu\nu)(\kappa\lambda)} - \frac{1}{2}\mathbf{R}g_{(\mu\nu)(\kappa\lambda)} = -8\pi G\mathcal{E}_{(\mu\nu)(\kappa\lambda)}. \tag{4.8}$$

Certainly, we can also add a cosmological term  $\lambda g_{(\mu\nu)(\kappa\lambda)}$  in (4.8) and obtain these gravitational equations

$$\widetilde{\mathcal{R}}_{(\mu\nu)(\kappa\lambda)} - \frac{1}{2}\mathbf{R}g_{(\mu\nu)(\kappa\lambda)} + \lambda g_{(\mu\nu)(\kappa\lambda)} = -8\pi G\mathcal{E}_{(\mu\nu)(\kappa\lambda)}. \tag{4.9}$$

All of these equations (4.8) and (4.9) mean that there are multi-space solutions in classical *Einstein's* gravitational equations by a multi-spacetime view, which will be shown in the next section.

### §5. Multi-Space Solutions of Einstein's Equations

For given integers  $0 < n_1 < n_2 < \dots < n_m, m \geq 1$ , let  $(\widetilde{M}, g, \widetilde{D})$  be a combinatorial Riemannian manifold with  $\widetilde{M} = \widetilde{M}(n_1, n_2, \dots, n_m)$  and  $(U_p, [\varphi_p])$  a local chart for  $p \in \widetilde{M}$ . By definition, if  $\varphi_p : U_p \rightarrow \bigcup_{i=1}^{s(p)} B^{n_i(p)}$  and  $\widehat{s}(p) = \dim(\bigcap_{i=1}^{s(p)} B^{n_i(p)})$ , then  $[\varphi_p]$  is an  $s(p) \times n_{s(p)}$  matrix shown following.

$$[\varphi_p] = \begin{bmatrix} \frac{x^{11}}{s(p)} & \dots & \frac{x^{1\widehat{s}(p)}}{s(p)} & x^{1(\widehat{s}(p)+1)} & \dots & x^{1n_1} & \dots & 0 \\ \frac{x^{21}}{s(p)} & \dots & \frac{x^{2\widehat{s}(p)}}{s(p)} & x^{2(\widehat{s}(p)+1)} & \dots & x^{2n_2} & \dots & 0 \\ \dots & \dots & \dots & \dots & \dots & \dots & \dots & \dots \\ \frac{x^{s(p)1}}{s(p)} & \dots & \frac{x^{s(p)\widehat{s}(p)}}{s(p)} & x^{s(p)(\widehat{s}(p)+1)} & \dots & \dots & x^{s(p)n_{s(p)}-1} & x^{s(p)n_{s(p)}} \end{bmatrix}$$

with  $x^{is} = x^{js}$  for  $1 \leq i, j \leq s(p), 1 \leq s \leq \widehat{s}(p)$ .

For given non-negative integers  $r, s, r + s \geq 1$ , choose a type  $(r, s)$  tensor  $\mathcal{F} \in T_s^r(\widetilde{M})$ . Then how to get multi-space solutions of a tensor equation

$$\mathcal{F} = 0 ?$$

We need to apply the *projective principle* following.

**[Projective Principle]** Let  $(\widetilde{M}, g, \widetilde{D})$  be a combinatorial Riemannian manifold and  $\mathcal{F} \in \langle T|T \in T_s^r(\widetilde{M}) \rangle$  with a local form  $\mathcal{F}_{(\mu_1\nu_1)(\mu_2\nu_2)\dots(\mu_s\nu_s)} \omega^{\mu_1\nu_1} \otimes \omega^{\mu_2\nu_2} \otimes \dots \otimes \omega^{\mu_s\nu_s}$  in  $(U_p, [\varphi_p])$ . If

$$\mathcal{F}_{(\mu_1\nu_1)(\mu_2\nu_2)\dots(\mu_s\nu_s)} = 0$$

for integers  $1 \leq \mu_i \leq s(p), 1 \leq \nu_i \leq n_{\mu_i}$  with  $1 \leq i \leq s$ , then for any integer  $\mu, 1 \leq \mu \leq s(p)$ , there must be

$$\mathcal{F}_{(\mu\nu_1)(\mu\nu_2)\dots(\mu\nu_s)} = 0$$

for integers  $\nu_i, 1 \leq \nu_i \leq n_\mu$  with  $1 \leq i \leq s$ .

Now we solve these vacuum *Einstein's* gravitational equations

$$\widetilde{R}_{(\mu\nu)(\kappa\lambda)} - \frac{1}{2}g_{(\mu\nu)(\kappa\lambda)}\mathbf{R} = 0 \tag{5.1}$$

by the projective principle on a combinatorially Riemannian manifold  $(\widetilde{M}, g, \widetilde{D})$ . For a given point  $p \in \widetilde{M}$ , we get  $s(p)$  tensor equations

$$\widetilde{R}_{(\mu\nu)(\mu\lambda)} - \frac{1}{2}g_{(\mu\nu)(\mu\lambda)}\mathbf{R} = 0, 1 \leq \mu \leq s(p) \tag{5.2}$$

as these usual vacuum *Einstein's* equations in classical gravitational field, where  $1 \leq \nu, \lambda \leq n_\mu$ . For line elements in  $\widetilde{M}$ , the next result is easily obtained.

**Theorem 5.1** *If each line element  $ds_\mu$  is uniquely determined by equations (5.2), Then  $\widetilde{d}s$  is uniquely determined in  $\widetilde{M}$ .*

*Proof* For a given index  $\mu$ , let

$$ds_\mu^2 = \sum_{i=1}^{n_\mu} a_{\mu i}^2 dx_{\mu i}^2.$$

Then we know that

$$\widetilde{d}s^2 = \sum_{i=1}^{\widehat{s}(p)} \left( \sum_{\mu=1}^{s(p)} a_{\mu i} \right)^2 dx_{\mu i}^2 + \sum_{\mu=1}^{s(p)} \sum_{i=\widehat{s}(p)+1}^{n_\mu} a_{\mu i}^2 dx_{\mu i}^2.$$

Therefore, the line element  $\widetilde{d}s$  is uniquely determined in  $\widetilde{M}$  if  $ds_{\mu i}$  is uniquely determined by (5.2). □

We consider a special case for these *Einstein's* gravitational equations (5.1), solutions of combinatorially Euclidean spaces  $\widetilde{M} = \bigcup_{i=1}^m \mathbf{R}^{n_i}$  with a matrix ([11])

$$[\bar{x}] = \begin{bmatrix} x^{11} & \dots & x^{1\widehat{m}} & x^{1(\widehat{m}+1)} & \dots & x^{1n_1} & \dots & 0 \\ x^{21} & \dots & x^{2\widehat{m}} & x^{2(\widehat{m}+1)} & \dots & x^{2n_2} & \dots & 0 \\ \dots & \dots & \dots & \dots & \dots & \dots & \dots & \dots \\ x^{m1} & \dots & x^{m\widehat{m}} & x^{m(\widehat{m}+1)} & \dots & \dots & x^{mn_{m-1}} & x^{mn_m} \end{bmatrix}$$

for any point  $\bar{x} \in \widetilde{M}$ , where  $\widehat{m} = \dim(\bigcap_{i=1}^m \mathbf{R}^{n_i})$  is a constant for  $\forall p \in \bigcap_{i=1}^m \mathbf{R}^{n_i}$  and  $x^{il} = \frac{x^l}{m}$  for  $1 \leq i \leq m, 1 \leq l \leq \widehat{m}$ . In this case, we have a unifying solution for these equations (5.1), i.e.,

$$\widetilde{ds}^2 = \sum_{i=1}^{\widehat{m}} \left( \sum_{\mu=1}^m a_{\mu i} \right)^2 dx_{\mu i}^2 + \sum_{\mu=1}^m \sum_{i=\widehat{m}+1}^{n_\mu} a_{\mu i}^2 dx_{\mu i}^2$$

for each point  $p \in \widetilde{M}$  by Theorem 5.1.

For usually undergoing, we consider the case of  $n_\mu = 4$  for  $1 \leq \mu \leq m$  since line elements have been found concretely in classical gravitational field in these cases. Now establish  $m$  spherical coordinate subframe  $(t_\mu; r_\mu, \theta_\mu, \phi_\mu)$  with its originality at the center of the mass space. Then we have known its a spherically symmetric solution for the line element  $ds_\mu$  with a given index  $\mu$  by *Schwarzschild* (see also [3]) for (5.2) to be

$$ds_\mu^2 = \left(1 - \frac{r_{\mu s}}{r_\mu}\right) c^2 dt_\mu^2 - \left(1 - \frac{r_{\mu s}}{r_\mu}\right)^{-1} dr_\mu^2 - r_\mu^2 (d\theta_\mu^2 + \sin^2 \theta_\mu d\phi_\mu^2).$$

for  $1 \leq \mu \leq m$ , where  $r_{\mu s} = 2Gm_\mu/c^2$ . Applying Theorem 5.1, the line element  $\widetilde{ds}$  in  $\widetilde{M}$  is

$$\widetilde{ds} = \left( \sum_{\mu=1}^m \sqrt{1 - \frac{r_{\mu s}}{r_\mu}} \right)^2 c^2 dt^2 - \sum_{\mu=1}^m \left(1 - \frac{r_{\mu s}}{r_\mu}\right)^{-1} dr_\mu^2 - \sum_{\mu=1}^m r_\mu^2 (d\theta_\mu^2 + \sin^2 \theta_\mu d\phi_\mu^2)$$

if  $\widehat{m} = 1$ ,  $t_\mu = t$  for  $1 \leq \mu \leq m$  and

$$\widetilde{ds} = \left( \sum_{\mu=1}^m \sqrt{1 - \frac{r_{\mu s}}{r_\mu}} \right)^2 c^2 dt^2 - \left( \sum_{\mu=1}^m \sqrt{\left(1 - \frac{r_{\mu s}}{r_\mu}\right)^{-1}} \right)^2 dr^2 - \sum_{\mu=1}^m r_\mu^2 (d\theta_\mu^2 + \sin^2 \theta_\mu d\phi_\mu^2)$$

if  $\widehat{m} = 2$ ,  $t_\mu = t, r_\mu = r$  for  $1 \leq \mu \leq m$  and

$$\widetilde{ds} = \left( \sum_{\mu=1}^m \sqrt{1 - \frac{r_{\mu s}}{r_\mu}} \right)^2 c^2 dt^2 - \left( \sum_{\mu=1}^m \sqrt{\left(1 - \frac{r_{\mu s}}{r_\mu}\right)^{-1}} \right)^2 dr^2 - m^2 r^2 d\theta^2 - \sum_{\mu=1}^m r_\mu^2 \sin^2 \theta_\mu d\phi_\mu^2$$

if  $\widehat{m} = 3$ ,  $t_\mu = t, r_\mu = r, \theta_\mu = \theta$  for  $1 \leq \mu \leq m$  and

$$\widetilde{ds} = \left( \sum_{\mu=1}^m \sqrt{1 - \frac{r_{\mu s}}{r_\mu}} \right)^2 c^2 dt^2 - \left( \sum_{\mu=1}^m \sqrt{\left(1 - \frac{r_{\mu s}}{r_\mu}\right)^{-1}} \right)^2 dr^2 - m^2 r^2 d\theta^2 - m^2 r^2 \sin^2 \theta d\phi^2$$

if  $\widehat{m} = 4$ ,  $t_\mu = t$ ,  $r_\mu = r$ ,  $\theta_\mu = \theta$  and  $\phi_\mu = \phi$  for  $1 \leq \mu \leq m$ .

For another interesting case, let  $\widehat{m} = 3$ ,  $r_\mu = r$ ,  $\theta_\mu = \theta$ ,  $\phi_\mu = \phi$  and

$$d\Omega^2(r, \theta, \phi) = (1 - \frac{r_s}{r})^{-1} dr^2 - r^2(d\theta^2 + \sin^2 \theta d\phi^2).$$

Then we can choose a multi-time system  $\{t_1, t_2, \dots, t_m\}$  to get a cosmic model of  $m$ ,  $m \geq 2$  combinatorially  $\mathbf{R}^4$  spaces with line elements

$$ds_1^2 = -c^2 dt_1^2 + a^2(t_1)d\Omega^2(r, \theta, \phi),$$

$$ds_2^2 = -c^2 dt_2^2 + a^2(t_2)d\Omega^2(r, \theta, \phi),$$

..... ,

$$ds_m^2 = -c^2 dt_m^2 + a^2(t_m)d\Omega^2(r, \theta, \phi).$$

In this case, the line element  $\widetilde{ds}$  is

$$\widetilde{ds} = \sum_{\mu=1}^m (1 - \frac{r_{\mu s}}{r_\mu}) c^2 dt_\mu^2 - (\sum_{\mu=1}^m \sqrt{(1 - \frac{r_{\mu s}}{r_\mu})^{-1}})^2 dr^2 - m^2 r^2 d\theta^2 - m^2 r^2 \sin^2 \theta d\phi^2.$$

As a by-product for our universe  $\mathbf{R}^3$ , these formulas mean that these beings with time notion different from human being will recognize differently the structure of our universe if these beings are intellectual enough for the structure of the universe.

**References**

[1] R.Abraham and J.E.Marsden, *Foundation of Mechanics*(2nd edition), Addison-Wesley, Reading, Mass, 1978.

[2] G.Bassini and S.Capozziello, Multi-spaces and many worlds from conservation laws, *Progress in Physics*, Vol.4(2006), 65-72.

[3] M.Carmeli, *Classical Fields-General Relativity and Gauge Theory*, World Scientific, 2001.

[4] W.H.Chern and X.X.Li, *Introduction to Riemannian Geometry*, Peking University Press, 2002.

[5] L.Kuciuk and M.Antholy, An Introduction to Smarandache Geometries, *JP Journal of Geometry and Topology*, 5(1), 2005,77-81.

[6] L.F.Mao, *Automorphism Groups of Maps, Surfaces and Smarandache Geometries*, American Research Press, 2005.

[7] L.F.Mao, *Smarandache multi-space theory*, Hexis, Phoenix, AZ2006.

[8] L.F.Mao, Combinatorial speculation and the combinatorial conjecture for mathematics, *Selected Papers on Mathematical Combinatorics*(I), 1-22, World Academic Union, 2006.

[9] L.F.Mao, Geometrical theory on combinatorial manifolds, *JP J.Geometry and Topology*, Vol.7, No.1(2007),65-114.

[10] L.F.Mao, An introduction to Smarandache multi-spaces and mathematical combinatorics, *Scientia Magna*, Vol.3, No.1(2007), 54-80.

- [11] L.F.Mao, A combinatorially generalized Stokes' theorem on integrations, *International J.Mathematical Combinatorics*, Vol.1, No.1(2007), 1-26.
- [12] F.Smarandache, Mixed noneuclidean geometries, *eprint arXiv: math.GM/0010119*, 10/2000.
- [13] F.Smarandache, A unifying field in logic: neutrosophic field, *Multi-value Logic*, Vol.8, No.3(2002), 385-438.
- [14] M.Tegmark, Parallel Universes, in *Science and Ultimate Reality: From Quantum to Cosmos*, ed. by J.D.Barrow, P.C.W.Davies and C.L.Harper, Cambridge University Press, 2003.



## Relativity in Combinatorial Gravitational Fields

**Abstract:** A combinatorial spacetime  $(\mathcal{C}_G|\bar{t})$  is a smoothly combinatorial manifold  $\mathcal{C}$  underlying a graph  $G$  evolving on a time vector  $\bar{t}$ . As we known, Einstein's general relativity is suitable for use only in one spacetime. *What is its disguise in a combinatorial spacetime?* Applying combinatorial Riemannian geometry enables us to present a combinatorial spacetime model for the Universe and suggest a generalized Einstein's gravitational equation in such model. For finding its solutions, a generalized relativity principle, called *projective principle* is proposed, i.e., *a physics law in a combinatorial spacetime is invariant under a projection on its a subspace* and then a spherically symmetric multi-solutions of generalized Einstein's gravitational equations in vacuum or charged body are found. We also consider the geometrical structure in such solutions with physical formations, and conclude that an ultimate theory for the Universe maybe established if all such spacetimes in  $\mathbf{R}^3$ . Otherwise, our theory is only an approximate theory and endless forever.

**Key Words:** Combinatorial spacetime, combinatorial Riemannian geometry, Einstein's gravitational equation, projective principle, combinatorial Reissner-Nordström metric, multi-space solution.

**AMS(2000):** 83C05, 83C15.

### §1. Combinatorial Spacetimes

The multi-laterality of our Universe implies the best spacetime model should be a combinatorial one. However, classical spacetimes are all in solitude. For example, the Newton's spacetime  $(\mathbf{R}^3|t)$  is a geometrical space  $(x_1, x_2, x_3) \in \mathbf{R}^3$  with an absolute time  $t \in \mathbf{R}^+$ . With his deep insight in physical laws, Einstein was aware of that all reference frames were established by human beings, which made him realized that *a physics law is invariant in any reference frame*. Whence, the Einstein's spacetime is  $(\mathbf{R}^3|t) \cong \mathbf{R}^4$  with  $t \in \mathbf{R}^+$ , i.e., a warped spacetime generating gravitation. In this kind of spacetime, its line element is

$$ds^2 = \sum_{0 \leq \mu, \nu \leq 3} g_{\mu\nu}(\bar{x}) dx_\mu dx_\nu,$$

where  $g_{\mu\nu}$ ,  $0 \leq \mu, \nu \leq 3$  are Riemannian metrics with local flat, i.e., the Minkowskian spacetime

$$ds^2 = -c^2 dt^2 + dx_1^2 + dx_2^2 + dx_3^2,$$

where  $c$  is the light speed. *Wether the spacetime of Universe is isolated?* In fact, there are

---

<sup>1</sup> *Progress in Physics* (Special Report), Vol.3 (2010), 39-50

no justifications for Newton’s or Einstein’s choice but only dependent on mankind’s perception with the geometry of visible, i.e., the spherical geometry(see [1]-[4] for details).

Certainly, different standpoints had unilaterally brought about particular behaviors of the Universe such as those of electricity, magnetism, thermal, optics ... in physics and their combinations, for example, the thermodynamics, electromagnetism, ..., etc.. But the true colours of the Universe should be hybrid, not homogenous or unilateral. They should be a union or a combination of all these features underlying a combinatorial structure. That is the origin of combinatorial spacetime established on smoothly combinatorial manifolds following ([5]-[9]), another form of Smarandache multi-space ([10]-[11]) underlying a connected graph.

**Definition 1.1** Let  $n_i, 1 \leq i \leq m$  be positive integers. A combinatorial Euclidean space is a combinatorial system  $\mathcal{C}_G$  of Euclidean spaces  $\mathbf{R}^{n_1}, \mathbf{R}^{n_2}, \dots, \mathbf{R}^{n_m}$  underlying a connected graph  $G$  defined by

$$V(G) = \{\mathbf{R}^{n_1}, \mathbf{R}^{n_2}, \dots, \mathbf{R}^{n_m}\},$$

$$E(G) = \{(\mathbf{R}^{n_i}, \mathbf{R}^{n_j}) \mid \mathbf{R}^{n_i} \cap \mathbf{R}^{n_j} \neq \emptyset, 1 \leq i, j \leq m\},$$

denoted by  $\mathcal{E}_G(n_1, \dots, n_m)$  and abbreviated to  $\mathcal{E}_G(r)$  if  $n_1 = \dots = n_m = r$ .

A combinatorial fan-space  $\tilde{\mathbf{R}}(n_1, \dots, n_m)$  is a combinatorial Euclidean space  $\mathcal{E}_{K_m}(n_1, \dots, n_m)$  of  $\mathbf{R}^{n_1}, \mathbf{R}^{n_2}, \dots, \mathbf{R}^{n_m}$  such that for any integers  $i, j, 1 \leq i \neq j \leq m, \mathbf{R}^{n_i} \cap \mathbf{R}^{n_j} = \bigcap_{k=1}^m \mathbf{R}^{n_k}$ , which is in fact a  $p$ -brane with  $p = \dim \bigcap_{k=1}^m \mathbf{R}^{n_k}$  in string theory ([12]), seeing Fig.1 for details.

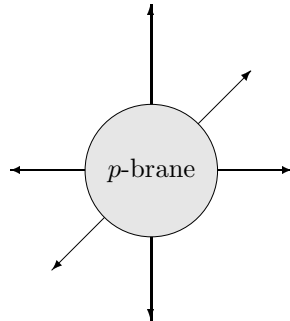

**Fig.1**

For  $\forall p \in \tilde{\mathbf{R}}(n_1, \dots, n_m)$  we can present it by an  $m \times n_m$  coordinate matrix  $[\bar{x}]$  following with  $x_{il} = \frac{x_l}{m}$  for  $1 \leq i \leq m, 1 \leq l \leq \hat{m}$ ,

$$[\bar{x}] = \begin{bmatrix} x_{11} & \cdots & x_{1\hat{m}} & \cdots & x_{1n_1} & \cdots & 0 \\ x_{21} & \cdots & x_{2\hat{m}} & \cdots & x_{2n_2} & \cdots & 0 \\ \cdots & \cdots & \cdots & \cdots & \cdots & \cdots & \cdots \\ x_{m1} & \cdots & x_{m\hat{m}} & \cdots & \cdots & \cdots & x_{mn_m} \end{bmatrix}.$$

A topological combinatorial manifold  $\tilde{M}$  is defined in the next.

**Definition 1.2** For a given integer sequence  $0 < n_1 < n_2 < \dots < n_m, m \geq 1$ , a topological combinatorial manifold  $\widetilde{M}$  is a Hausdorff space such that for any point  $p \in \widetilde{M}$ , there is a local chart  $(U_p, \varphi_p)$  of  $p$ , i.e., an open neighborhood  $U_p$  of  $p$  in  $\widetilde{M}$  and a homoeomorphism  $\varphi_p : U_p \rightarrow \widetilde{\mathbf{R}}(n_1(p), \dots, n_{s(p)}(p))$  with

$$\{n_1(p), \dots, n_{s(p)}(p)\} \subseteq \{n_1, \dots, n_m\},$$

$$\bigcup_{p \in \widetilde{M}} \{n_1(p), \dots, n_{s(p)}(p)\} = \{n_1, \dots, n_m\},$$

denoted by  $\widetilde{M}(n_1, n_2, \dots, n_m)$  or  $\widetilde{M}$  on the context and

$$\widetilde{\mathcal{A}} = \{(U_p, \varphi_p) | p \in \widetilde{M}(n_1, n_2, \dots, n_m)\}$$

an atlas on  $\widetilde{M}(n_1, n_2, \dots, n_m)$ .

A topological combinatorial manifold  $\widetilde{M}$  is finite if it is just combined by finite manifolds without one manifold contained in the union of others.

For a finite combinatorial manifold  $\widetilde{M}$  consisting of manifolds  $M_i, 1 \leq i \leq m$ , we can construct a vertex-edge labeled graph  $G^L[\widetilde{M}]$  defined by

$$V(G^L[\widetilde{M}]) = \{M_1, M_2, \dots, M_m\},$$

$$E(G^L[\widetilde{M}]) = \{(M_i, M_j) \mid M_i \cap M_j \neq \emptyset, 1 \leq i, j \leq m\}$$

with a labeling mapping

$$\Theta : V(G^L[\widetilde{M}]) \cup E(G^L[\widetilde{M}]) \rightarrow \mathbf{Z}^+$$

determined by

$$\Theta(M_i) = \dim M_i, \quad \Theta(M_i, M_j) = \dim M_i \cap M_j$$

for integers  $1 \leq i, j \leq m$ , which is inherent structure of combinatorial manifolds. A differentiable combinatorial manifold is defined by endowing differential structure on a topological combinatorial manifold following.

**Definition 1.3** For a given integer sequence  $1 \leq n_1 < n_2 < \dots < n_m$ , a combinatorial  $C^h$ -differential manifold  $(\widetilde{M}(n_1, n_2, \dots, n_m); \widetilde{\mathcal{A}})$  is a finite combinatorial manifold  $\widetilde{M}(n_1, \dots, n_m)$ ,  $\widetilde{M}(n_1, \dots, n_m) = \bigcup_{i \in I} U_i$ , endowed with an atlas  $\widetilde{\mathcal{A}} = \{(U_\alpha; \varphi_\alpha) \mid \alpha \in I\}$  on  $\widetilde{M}(n_1, \dots, n_m)$  for an integer  $h, h \geq 1$  with conditions following hold.

(1)  $\{U_\alpha; \alpha \in I\}$  is an open covering of  $\widetilde{M}(n_1, n_2, \dots, n_m)$ .

(2) For  $\forall \alpha, \beta \in I$ , local charts  $(U_\alpha; \varphi_\alpha)$  and  $(U_\beta; \varphi_\beta)$  are equivalent, i.e.,  $U_\alpha \cap U_\beta = \emptyset$  or  $U_\alpha \cap U_\beta \neq \emptyset$  but the overlap maps

$$\varphi_\alpha \varphi_\beta^{-1} : \varphi_\beta(U_\alpha \cap U_\beta) \rightarrow \varphi_\alpha(U_\alpha),$$

$$\varphi_\beta \varphi_\alpha^{-1} : \varphi_\alpha(U_\alpha \cap U_\beta) \rightarrow \varphi_\beta(U_\beta)$$

both are  $C^h$ -mappings, such as those shown in Fig.2 following.

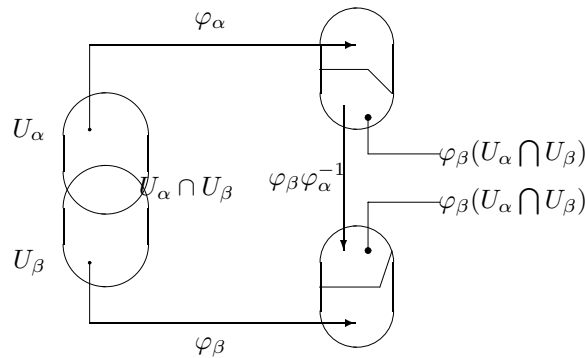

Fig.2

(3)  $\tilde{\mathcal{A}}$  is maximal, i.e., if  $(U; \varphi)$  is a local chart of  $\tilde{M}(n_1, \dots, n_m)$  equivalent with one of local charts in  $\tilde{\mathcal{A}}$ , then  $(U; \varphi) \in \tilde{\mathcal{A}}$ .

A finite combinatorial manifold  $\tilde{M}(n_1, \dots, n_m)$  is smooth if it is endowed with a  $C^\infty$ -differential structure. Now we are in the place introducing combinatorial spacetime.

**Definition 1.4** A combinatorial spacetime  $(\mathcal{C}_G | \bar{t})$  is a smooth combinatorial manifold  $\mathcal{C}$  underlying a graph  $G$  evolving on a time vector  $\bar{t}$ , i.e., a geometrical space  $\mathcal{C}$  with a time system  $\bar{t}$  such that  $(\bar{x} | \bar{t})$  is a particle's position at a time  $\bar{t}$  for  $\bar{x} \in \mathcal{C}$ .

The existence of combinatorial spacetime in the Universe is a wide-ranging, even if in the society science. By the explaining in the reference [13], there are four-level hierarchy of multi-spaces analyzed by knowledge of mankind already known, such as those of *Hubble volumes*, *chaotic inflation*, *wavefunction* and *mathematical equations*, etc.. Each level is allowed progressively greater diversity.

**Question 1.5** How to deal behaviors of these different combinatorial spacetimes definitely with mathematics, not only qualitatively?

Recently, many researchers work for brane-world cosmology, particular for the case of dimensional  $\leq 6$ , such as those researches in references [14]-[18] and [3] etc.. This brane-world model was also applied in [19] for explaining a black hole model for the Universe by combination. Notice that the underlying combinatorial structure of brane-world cosmological model is essentially a tree for simplicity.

Now we have established a differential geometry on combinatorial manifolds in references [5] – [9], which provides us with a mathematical tool for determining the behavior of combinatorial spacetimes. The main purpose of this paper is to apply it to combinatorial gravitational fields combining with spacetime's characters, present a generalized relativity in combinatorial fields and use this principle to solve the gravitational field equations. We also discuss the consistency of this combinatorial model for the Universe with some observing data such as the cosmic microwave background (CMB) radiation by WMAP in 2003.

§2. Curvature Tensor on Combinatorial Manifolds

Applying combinatorial spacetimes to that of gravitational field needs us to introduce curvature tensor for measuring the warping of combinatorial manifolds. In this section, we explain conceptions with results appeared in references [5]-[8], which are applied in this paper.

First, the structure of tangent and cotangent spaces  $T_p\widetilde{M}, T_p^*\widetilde{M}$  at any point  $p \in \widetilde{M}$  in a smoothly combinatorial manifold  $\widetilde{M}$  is similar to that of differentiable manifold. It has been shown in [5] that  $\dim T_p\widetilde{M}(n_1, \dots, n_m) = \widehat{s}(p) + \sum_{i=1}^{s(p)} (n_i - \widehat{s}(p))$  and  $\dim T_p^*\widetilde{M}(n_1, n_2, \dots, n_m) = \widehat{s}(p) + \sum_{i=1}^{s(p)} (n_i - \widehat{s}(p))$  with a basis

$$\left\{ \frac{\partial}{\partial x^{i_0 j}} \Big|_p \mid 1 \leq j \leq \widehat{s}(p) \right\} \cup \left( \bigcup_{i=1}^{s(p)} \left\{ \frac{\partial}{\partial x^{ij}} \Big|_p \mid \widehat{s}(p) + 1 \leq j \leq n_i \right\} \right),$$

$$\left\{ dx^{i_0 j} \Big|_p \mid 1 \leq j \leq \widehat{s}(p) \right\} \cup \left( \bigcup_{i=1}^{s(p)} \left\{ dx^{ij} \Big|_p \mid \widehat{s}(p) + 1 \leq j \leq n_i \right\} \right)$$

for any integer  $i_0, 1 \leq i_0 \leq s(p)$ , respectively. These mathematical structures enable us to construct tensors, connections on tensors and curvature tensors on smoothly combinatorial manifolds.

**Definition 2.1** Let  $\widetilde{M}$  be a smoothly combinatorial manifold,  $p \in \widetilde{M}$ . A tensor of type  $(r, s)$  at the point  $p$  on  $\widetilde{M}$  is an  $(r + s)$ -multilinear function  $\tau$ ,

$$\tau : \underbrace{T_p^*\widetilde{M} \times \dots \times T_p^*\widetilde{M}}_r \times \underbrace{T_p\widetilde{M} \times \dots \times T_p\widetilde{M}}_s \rightarrow \mathbf{R}.$$

Let  $\widetilde{M}(n_1, \dots, n_m)$  be a smoothly combinatorial manifold. Denoted by  $T_s^r(p, \widetilde{M})$  all tensors of type  $(r, s)$  at a point  $p$  of  $\widetilde{M}(n_1, \dots, n_m)$ . Then for  $\forall p \in \widetilde{M}(n_1, \dots, n_m)$ , we have known that

$$T_s^r(p, \widetilde{M}) = \underbrace{T_p\widetilde{M} \otimes \dots \otimes T_p\widetilde{M}}_r \otimes \underbrace{T_p^*\widetilde{M} \otimes \dots \otimes T_p^*\widetilde{M}}_s,$$

where

$$T_p\widetilde{M} = T_p\widetilde{M}(n_1, \dots, n_m), \quad T_p^*\widetilde{M} = T_p^*\widetilde{M}(n_1, \dots, n_m),$$

particularly,

$$\dim T_s^r(p, \widetilde{M}) = (\widehat{s}(p) + \sum_{i=1}^{s(p)} (n_i - \widehat{s}(p)))^{r+s}$$

by argumentations in [5] – [7]. A connection on tensors of a smooth combinatorial manifold is defined by

**Definition 2.2** Let  $\widetilde{M}$  be a smooth combinatorial manifold. A connection on tensors of  $\widetilde{M}$  is a mapping  $\widetilde{D} : \mathcal{X}(\widetilde{M}) \times T_s^r\widetilde{M} \rightarrow T_s^r\widetilde{M}$  with  $\widetilde{D}_X\tau = \widetilde{D}(X, \tau)$  such that for  $\forall X, Y \in \mathcal{X}\widetilde{M}$ ,

$\tau, \pi \in T_s^r(\widetilde{M}), \lambda \in \mathbf{R}$  and  $f \in C^\infty(\widetilde{M})$ ,

$$(1) \widetilde{D}_{X+fY}\tau = \widetilde{D}_X\tau + f\widetilde{D}_Y\tau \text{ and } \widetilde{D}_X(\tau + \lambda\pi) = \widetilde{D}_X\tau + \lambda\widetilde{D}_X\pi;$$

$$(2) \widetilde{D}_X(\tau \otimes \pi) = \widetilde{D}_X\tau \otimes \pi + \sigma \otimes \widetilde{D}_X\pi;$$

(3) for any contraction  $C$  on  $T_s^r(\widetilde{M})$ ,

$$\widetilde{D}_X(C(\tau)) = C(\widetilde{D}_X\tau).$$

For a smooth combinatorial manifold  $\widetilde{M}$ , we have shown in [5] that there always exists a connection  $\widetilde{D}$  on  $\widetilde{M}$  with coefficients  $\Gamma_{(\sigma\varsigma)(\mu\nu)}^{\kappa\lambda}$  determined by

$$\widetilde{D}_{\frac{\partial}{\partial x^{\mu\nu}}} \frac{\partial}{\partial x^{\sigma\varsigma}} = \Gamma_{(\sigma\varsigma)(\mu\nu)}^{\kappa\lambda} \frac{\partial}{\partial x^{\sigma\varsigma}}.$$

A combinatorially connection space  $(\widetilde{M}, \widetilde{D})$  is a smooth combinatorial manifold  $\widetilde{M}$  with a connection  $\widetilde{D}$ .

**Definition 2.3** Let  $\widetilde{M}$  be a smoothly combinatorial manifold and  $g \in A^2(\widetilde{M}) = \bigcup_{p \in \widetilde{M}} T_2^0(p, \widetilde{M})$ .

If  $g$  is symmetrical and positive, then  $\widetilde{M}$  is called a combinatorially Riemannian manifold, denoted by  $(\widetilde{M}, g)$ . In this case, if there is also a connection  $\widetilde{D}$  on  $(\widetilde{M}, g)$  with equality following hold

$$Z(g(X, Y)) = g(\widetilde{D}_Z, Y) + g(X, \widetilde{D}_Z Y),$$

then  $\widetilde{M}$  is called a combinatorially Riemannian geometry, denoted by  $(\widetilde{M}, g, \widetilde{D})$ .

It has been proved in [5] and [7] that there exists a unique connection  $\widetilde{D}$  on  $(\widetilde{M}, g)$  such that  $(\widetilde{M}, g, \widetilde{D})$  is a combinatorially Riemannian geometry.

**Definition 2.4** Let  $(\widetilde{M}, \widetilde{D})$  be a combinatorially connection space. For  $\forall X, Y \in \mathcal{X}(\widetilde{M})$ , a combinatorially curvature operator  $\widetilde{\mathcal{R}}(X, Y) : \mathcal{X}(\widetilde{M}) \rightarrow \mathcal{X}(\widetilde{M})$  is defined by

$$\widetilde{\mathcal{R}}(X, Y)Z = \widetilde{D}_X\widetilde{D}_Y Z - \widetilde{D}_Y\widetilde{D}_X Z - \widetilde{D}_{[X, Y]}Z$$

for  $\forall Z \in \mathcal{X}(\widetilde{M})$ .

**Definition 2.5** Let  $(\widetilde{M}, \widetilde{D})$  be a combinatorially connection space. For  $\forall X, Y, Z \in \mathcal{X}(\widetilde{M})$ , a linear multi-mapping  $\widetilde{\mathcal{R}} : \mathcal{X}(\widetilde{M}) \times \mathcal{X}(\widetilde{M}) \times \mathcal{X}(\widetilde{M}) \rightarrow \mathcal{X}(\widetilde{M})$  determined by

$$\widetilde{\mathcal{R}}(Z, X, Y) = \widetilde{\mathcal{R}}(X, Y)Z$$

is said a curvature tensor of type (1, 3) on  $(\widetilde{M}, \widetilde{D})$ .

Calculation in [7] shows that for  $\forall p \in \widetilde{M}$  with a local chart  $(U_p; [\varphi_p])$ ,

$$\widetilde{\mathcal{R}} = \widetilde{\mathcal{R}}_{(\sigma\varsigma)(\mu\nu)(\kappa\lambda)}^{\eta\theta} dx^{\sigma\varsigma} \otimes \frac{\partial}{\partial x^{\eta\theta}} \otimes dx^{\mu\nu} \otimes dx^{\kappa\lambda}$$

with

$$\begin{aligned} \tilde{\mathcal{R}}_{(\sigma\varsigma)(\mu\nu)(\kappa\lambda)}^{\eta\theta} &= \frac{\partial\Gamma_{(\sigma\varsigma)(\kappa\lambda)}^{\eta\theta}}{\partial x^{\mu\nu}} - \frac{\partial\Gamma_{(\sigma\varsigma)(\mu\nu)}^{\eta\theta}}{\partial x^{\kappa\lambda}} + \Gamma_{(\sigma\varsigma)(\kappa\lambda)}^{\vartheta\iota} \Gamma_{(\vartheta\iota)(\mu\nu)}^{\eta\theta} \\ &\quad - \Gamma_{(\sigma\varsigma)(\mu\nu)}^{\vartheta\iota} \Gamma_{(\vartheta\iota)(\kappa\lambda)}^{\eta\theta} \frac{\partial}{\partial x^{\vartheta\iota}}, \end{aligned}$$

where,  $\Gamma_{(\mu\nu)(\kappa\lambda)}^{\sigma\varsigma} \in C^\infty(U_p)$  is determined by

$$\tilde{D}_{\frac{\partial}{\partial x^{\mu\nu}}} \frac{\partial}{\partial x^{\kappa\lambda}} = \Gamma_{(\kappa\lambda)(\mu\nu)}^{\sigma\varsigma} \frac{\partial}{\partial x^{\sigma\varsigma}}.$$

Particularly, if  $(\tilde{M}, g, \tilde{D})$  is a combinatorially Riemannian geometry, we know the combinatorially Riemannian curvature tensor in the following.

**Definition 2.6** *Let  $(\tilde{M}, g, \tilde{D})$  be a combinatorially Riemannian manifold. A combinatorially Riemannian curvature tensor  $\tilde{R}: \mathcal{X}(\tilde{M}) \times \mathcal{X}(\tilde{M}) \times \mathcal{X}(\tilde{M}) \times \mathcal{X}(\tilde{M}) \rightarrow C^\infty(\tilde{M})$  of type  $(0, 4)$  is defined by*

$$\tilde{R}(X, Y, Z, W) = g(\tilde{R}(Z, W)X, Y)$$

for  $\forall X, Y, Z, W \in \mathcal{X}(\tilde{M})$ .

Now let  $(\tilde{M}, g, \tilde{D})$  be a combinatorially Riemannian manifold. For  $\forall p \in \tilde{M}$  with a local chart  $(U_p; [\varphi_p])$ , we have known that ([8])

$$\tilde{R} = \tilde{R}_{(\sigma\varsigma)(\eta\theta)(\mu\nu)(\kappa\lambda)} dx^{\sigma\varsigma} \otimes dx^{\eta\theta} \otimes dx^{\mu\nu} \otimes dx^{\kappa\lambda}$$

with

$$\begin{aligned} \tilde{R}_{(\sigma\varsigma)(\eta\theta)(\mu\nu)(\kappa\lambda)} &= \frac{1}{2} \left( \frac{\partial^2 g_{(\mu\nu)(\sigma\varsigma)}}{\partial x^{\kappa\lambda} \partial x^{\eta\theta}} + \frac{\partial^2 g_{(\kappa\lambda)(\eta\theta)}}{\partial x^{\mu\nu} \partial x^{\sigma\varsigma}} - \frac{\partial^2 g_{(\mu\nu)(\eta\theta)}}{\partial x^{\kappa\lambda} \partial x^{\sigma\varsigma}} - \frac{\partial^2 g_{(\kappa\lambda)(\sigma\varsigma)}}{\partial x^{\mu\nu} \partial x^{\eta\theta}} \right) \\ &\quad + \Gamma_{(\mu\nu)(\sigma\varsigma)}^{\vartheta\iota} \Gamma_{(\kappa\lambda)(\eta\theta)}^{\xi\omicron} g_{(\xi\omicron)(\vartheta\iota)} - \Gamma_{(\mu\nu)(\eta\theta)}^{\xi\omicron} \Gamma_{(\kappa\lambda)(\sigma\varsigma)\vartheta\iota} g_{(\xi\omicron)(\vartheta\iota)}, \end{aligned}$$

where  $g_{(\mu\nu)(\kappa\lambda)} = g\left(\frac{\partial}{\partial x^{\mu\nu}}, \frac{\partial}{\partial x^{\kappa\lambda}}\right)$ .

Application of these mechanisms in Definitions 2.1 – 2.6 with results obtained in references [5]-[9], [20]-[23] enables us to find physical laws in combinatorial spacetimes by mathematical equations, and then find their multi-solutions in following sections.

### §3. Combinatorial Gravitational Fields

#### 3.1 Gravitational Equations

The essence in Einstein’s notion on the gravitational field is known in two principles following.

**Principle 3.1** *These gravitational forces and inertial forces acting on a particle in a gravitational field are equivalent and indistinguishable from each other.*

**Principle 3.2** *An equation describing a law of physics should have the same form in all*

reference frame.

By Principle 3.1, one can introduce inertial coordinate system in Einstein's spacetime which enables it flat locally, i.e., transfer these Riemannian metrics to Minkowskian ones and eliminate the gravitational forces locally. Principle 3.2 means that a physical equation should be a tensor equation. But *how about the combinatorial gravitational field?* We assume Principles 3.1 and 3.2 hold in this case, i.e., a physical law is characterized by a tensor equation. This assumption enables us to deduce the gravitational field equation following.

Let  $\mathcal{L}_{G^L[\tilde{M}]}$  be the Lagrange density of a combinatorial spacetime  $(\mathcal{C}_G|\tilde{t})$ . Then we know equations of the combinatorial gravitational field  $(\mathcal{C}_G|\tilde{t})$  to be

$$\partial_\mu \frac{\partial \mathcal{L}_{G^L[\tilde{M}]}}{\partial \partial_\mu \phi_{\tilde{M}}} - \frac{\partial \mathcal{L}_{G^L[\tilde{M}]}}{\partial \phi_{\tilde{M}}} = 0, \quad (3-1)$$

by the Euler-Lagrange equation, where  $\phi_{\tilde{M}}$  is the wave function of  $(\mathcal{C}_G|\tilde{t})$ . Choose its Lagrange density  $\mathcal{L}_{G^L[\tilde{M}]}$  to be

$$\mathcal{L}_{G^L[\tilde{M}]} = \tilde{R} - 2\kappa \mathcal{L}_F,$$

where  $\kappa = -8\pi G$  and  $\mathcal{L}_F$  the Lagrange density for all other fields with

$$\tilde{R} = g^{(\mu\nu)(\kappa\lambda)} \tilde{R}_{(\mu\nu)(\kappa\lambda)}, \quad \tilde{R}_{(\mu\nu)(\kappa\lambda)} = \tilde{R}_{(\mu\nu)(\sigma\varsigma)(\kappa\lambda)}^{\sigma\varsigma}.$$

Applying the Euler-Lagrange equation we get the equation of combinatorial gravitational field following

$$\tilde{\mathcal{R}}_{(\mu\nu)(\kappa\lambda)} - \frac{1}{2} \tilde{R} g_{(\mu\nu)(\kappa\lambda)} = \kappa \mathcal{E}_{(\mu\nu)(\kappa\lambda)}, \quad (3-2)$$

where  $\mathcal{E}_{(\mu\nu)(\kappa\lambda)}$  is the energy-momentum tensor.

The situation for combinatorial gravitational field is a little different from classical field by its combinatorial character with that one can only determines unilateral or part behaviors of the field. We generalize the Einstein's notion to combinatorial gravitational field by the following projective principle, which is coordinated with one's observation.

**Principle 3.3** *A physics law in a combinatorial field is invariant under a projection on its a field.*

By Principles 3.1 and 3.2 with combinatorial differential geometry shown in Section 2, Principle 3.3 can be rephrased as follows.

**Projective Principle** *Let  $(\tilde{M}, g, \tilde{D})$  be a combinatorial Riemannian manifold and  $\mathcal{F} \in T_s^r(\tilde{M})$  with a local form*

$$\mathcal{F}_{(\mu_1\nu_1)\dots(\mu_s\nu_s)}^{(\kappa_1\lambda_1)\dots(\kappa_r\lambda_r)} e_{\kappa_1\lambda_1} \otimes \dots \otimes e_{\kappa_r\lambda_r} \omega^{\mu_1\nu_1} \otimes \dots \otimes \omega^{\mu_s\nu_s}$$

in  $(U_p, [\varphi_p])$ . If

$$\mathcal{F}_{(\mu_1\nu_1)\dots(\mu_s\nu_s)}^{(\kappa_1\lambda_1)\dots(\kappa_r\lambda_r)} = 0$$



for integers  $1 \leq \mu_i \leq s(p), 1 \leq \nu_i \leq n_{\mu_i}$  with  $1 \leq i \leq s$  and  $1 \leq \kappa_j \leq s(p), 1 \leq \lambda_j \leq n_{\kappa_j}$  with  $1 \leq j \leq r$ , then for any integer  $\mu, 1 \leq \mu \leq s(p)$ , there must be

$$\mathcal{F}_{(\mu\nu_1)\dots(\mu\nu_s)}^{(\mu\lambda_1)\dots(\mu\lambda_r)} = 0$$

for integers  $\nu_i, 1 \leq \nu_i \leq n_{\mu}$  with  $1 \leq i \leq s$ .

Certainly, we can only determine the behavior of space which we live. Then *what is about these other spaces in  $(\mathcal{E}_G|\bar{t})$ ?* Applying the projective principle, we can simulate each of them by that of our living space. In other words, combining geometrical structures already known to a combinatorial one  $(\mathcal{E}_G|\bar{t})$  and then find its solution for equation (3 – 2).

### 3.2 Combinatorial Metric

Let  $\tilde{\mathcal{A}}$  be an atlas on  $(\tilde{M}, g, \tilde{D})$ . Choose a local chart  $(U; \varpi)$  in  $\tilde{\mathcal{A}}$ . By definition, if  $\varphi_p : U_p \rightarrow \bigcup_{i=1}^{s(p)} B^{n_i(p)}$  and  $\hat{s}(p) = \dim(\bigcap_{i=1}^{s(p)} B^{n_i(p)})$ , then  $[\varphi_p]$  is an  $s(p) \times n_{s(p)}$  matrix. A *combinatorial metric* is defined by

$$ds^2 = g_{(\mu\nu)(\kappa\lambda)} dx^{\mu\nu} dx^{\kappa\lambda}, \quad (3 - 3)$$

where  $g_{(\mu\nu)(\kappa\lambda)}$  is the Riemannian metric in the combinatorially Riemannian manifold  $(\tilde{M}, g, \tilde{D})$ . Generally, we choose a orthogonal basis

$$\{\bar{e}_{11}, \dots, \bar{e}_{1n_1}, \dots, \bar{e}_{s(p)n_{s(p)}}\}$$

for  $\varphi_p[U], p \in \tilde{M}(t)$ , i.e.,  $\langle \bar{e}_{\mu\nu}, \bar{e}_{\kappa\lambda} \rangle = \delta_{(\mu\nu)}^{(\kappa\lambda)}$ . Then the formula (3 – 3) turns to

$$\begin{aligned} ds^2 &= g_{(\mu\nu)(\mu\nu)} (dx^{\mu\nu})^2 \\ &= \sum_{\mu=1}^{s(p)} \sum_{\nu=1}^{\hat{s}(p)} g_{(\mu\nu)(\mu\nu)} (dx^{\mu\nu})^2 + \sum_{\mu=1}^{s(p)} \sum_{\nu=1}^{\hat{s}(p)+1} g_{(\mu\nu)(\mu\nu)} (dx^{\mu\nu})^2 \\ &= \frac{1}{s^2(p)} \sum_{\nu=1}^{\hat{s}(p)} \left( \sum_{\mu=1}^{s(p)} g_{(\mu\nu)(\mu\nu)} \right) dx^\nu + \sum_{\mu=1}^{s(p)} \sum_{\nu=1}^{\hat{s}(p)+1} g_{(\mu\nu)(\mu\nu)} (dx^{\mu\nu})^2. \end{aligned}$$

We therefore find an important relation of combinatorial metric with that of its projections following.

**Theorem 3.1** *Let  ${}_\mu ds^2$  be the metric in a manifold  $\phi_p^{-1}(B^{n_\mu(p)})$  for integers  $1 \leq \mu \leq s(p)$ . Then*

$$ds^2 = {}_1 ds^2 + {}_2 ds^2 + \dots + {}_{s(p)} ds^2.$$

*Proof* Applying the projective principle, we immediately know that

$${}_\mu ds^2 = ds^2|_{\phi_p^{-1}(B^{n_\mu(p)})}, \quad 1 \leq \mu \leq s(p).$$

Whence, we find that

$$\begin{aligned} ds^2 &= g_{(\mu\nu)(\mu\nu)}(dx^{\mu\nu})^2 = \sum_{\mu=1}^{s(p)} \sum_{\nu=1}^{n_i(p)} g_{(\mu\nu)(\mu\nu)}(dx^{\mu\nu})^2 \\ &= \sum_{\mu=1}^{s(p)} ds^2|_{\phi_p^{-1}(B^{n_\mu(p)})} = \sum_{\mu=1}^{s(p)} \mu ds^2. \quad \square \end{aligned}$$

This relation enables us to find the line element of combinatorial gravitational field  $(\mathcal{C}_G|\bar{t})$  by applying that of gravitational fields.

### 3.3 Combinatorial Schwarzschild Metric

Let  $(\mathcal{C}_G|\bar{t})$  be a gravitational field. We know its Schwarzschild metric, i.e., a spherically symmetric solution of Einstein's gravitational equations in vacuum is

$$ds^2 = \left(1 - \frac{r_s}{r}\right) dt^2 - \frac{dr^2}{1 - \frac{r_s}{r}} - r^2 d\theta^2 - r^2 \sin^2 \theta d\phi^2 \quad (3-4)$$

where  $r_s = 2Gm/c^2$ . Now we generalize it to combinatorial gravitational fields to find the solutions of equations

$$R_{(\mu\nu)(\sigma\tau)} - \frac{1}{2}g_{(\mu\nu)(\sigma\tau)}R = -8\pi G\mathcal{E}_{(\mu\nu)(\sigma\tau)}$$

in vacuum, i.e.,  $\mathcal{E}_{(\mu\nu)(\sigma\tau)} = 0$ . Notice that the underlying graph of combinatorial field consisting of  $m$  gravitational fields is a complete graph  $K_m$ . For such a objective, we only consider the homogenous combinatorial Euclidean spaces  $\widetilde{M} = \bigcup_{i=1}^m \mathbf{R}^{n_i}$ , i.e., for any point  $p \in \widetilde{M}$ ,

$$[\varphi_p] = \begin{bmatrix} x^{11} & \dots & x^{1n_1} & \dots & 0 \\ x^{21} & \dots & x^{2n_2} & \dots & 0 \\ \dots & \dots & \dots & \dots & \dots \\ x^{m1} & \dots & \dots & \dots & x^{mn_m} \end{bmatrix}$$

with  $\widehat{m} = \dim\left(\bigcap_{i=1}^m \mathbf{R}^{n_i}\right)$  a constant for  $\forall p \in \bigcap_{i=1}^m \mathbf{R}^{n_i}$  and  $x^{il} = \frac{x^l}{m}$  for  $1 \leq i \leq m, 1 \leq l \leq \widehat{m}$ .

Let  $(\mathcal{C}_G|\bar{t})$  be a combinatorial field of gravitational fields  $M_1, \dots, M_m$  with masses  $m_1, \dots, m_m$  respectively. For usually undergoing, we consider the case of  $n_\mu = 4$  for  $1 \leq \mu \leq m$  since line elements have been found concretely in classical gravitational field in these cases. Now establish  $m$  spherical coordinate subframe  $(t_\mu; r_\mu, \theta_\mu, \phi_\mu)$  with its originality at the center of such a mass space. Then we have known its a spherically symmetric solution by (3-4) to be

$$ds_\mu^2 = \left(1 - \frac{r_{\mu s}}{r_\mu}\right) dt_\mu^2 - \left(1 - \frac{r_{\mu s}}{r_\mu}\right)^{-1} dr_\mu^2 - r_\mu^2 (d\theta_\mu^2 + \sin^2 \theta_\mu d\phi_\mu^2)$$

for  $1 \leq \mu \leq m$  with  $r_{\mu s} = 2Gm_\mu/c^2$ . By Theorem 3.1, we know that

$$ds^2 = {}_1ds^2 + {}_2ds^2 + \cdots + {}_m ds^2,$$

where  ${}_\mu ds^2 = ds_\mu^2$  by the projective principle on combinatorial fields. Notice that  $1 \leq \widehat{m} \leq 4$ . We therefore get the geometrical of  $(\mathcal{C}_G|\bar{t})$  dependent on  $\widehat{m}$  following.

**Case 1.**  $\widehat{m} = 1$ , i.e.,  $t_\mu = t$  for  $1 \leq \mu \leq m$ .

In this case, the combinatorial metric  $ds$  is

$$ds^2 = \sum_{\mu=1}^m \left(1 - \frac{2Gm_\mu}{c^2 r_\mu}\right) dt^2 - \sum_{\mu=1}^m \left(1 - \frac{2Gm_\mu}{c^2 r_\mu}\right)^{-1} dr_\mu^2 - \sum_{\mu=1}^m r_\mu^2 (d\theta_\mu^2 + \sin^2 \theta_\mu d\phi_\mu^2).$$

**Case 2.**  $\widehat{m} = 2$ , i.e.,  $t_\mu = t$  and  $r_\mu = r$ , or  $t_\mu = t$  and  $\theta_\mu = \theta$ , or  $t_\mu = t$  and  $\phi_\mu = \phi$  for  $1 \leq \mu \leq m$ .

We consider the following subcases.

**Subcase 2.1.**  $t_\mu = t$ ,  $r_\mu = r$ .

In this subcase, the combinatorial metric is

$$ds^2 = \sum_{\mu=1}^m \left(1 - \frac{2Gm_\mu}{c^2 r}\right) dt^2 - \left(\sum_{\mu=1}^m \left(1 - \frac{2Gm_\mu}{c^2 r}\right)^{-1}\right) dr^2 - \sum_{\mu=1}^m r^2 (d\theta_\mu^2 + \sin^2 \theta_\mu d\phi_\mu^2),$$

which can only happens if these  $m$  fields are at a same point  $O$  in a space. Particularly, if  $m_\mu = M$  for  $1 \leq \mu \leq m$ , the masses of

$$M_1, M_2, \cdots, M_m$$

are the same, then  $r_{\mu g} = 2GM$  is a constant, which enables us knowing that

$$ds^2 = \left(1 - \frac{2GM}{c^2 r}\right) m dt^2 - \left(1 - \frac{2GM}{c^2 r}\right)^{-1} m dr^2 - \sum_{\mu=1}^m r^2 (d\theta_\mu^2 + \sin^2 \theta_\mu d\phi_\mu^2).$$

**Subcase 2.2.**  $t_\mu = t$ ,  $\theta_\mu = \theta$ .

In this subcase, the combinatorial metric is

$$ds^2 = \sum_{\mu=1}^m \left(1 - \frac{2Gm_\mu}{c^2 r_\mu}\right) dt^2 - \sum_{\mu=1}^m \left(1 - \frac{2Gm_\mu}{c^2 r_\mu}\right)^{-1} dr_\mu^2 - \sum_{\mu=1}^m r_\mu^2 (d\theta^2 + \sin^2 \theta d\phi_\mu^2).$$

**Subcase 2.3.**  $t_\mu = t$ ,  $\phi_\mu = \phi$ .

In this subcase, the combinatorial metric is

$$ds^2 = \sum_{\mu=1}^m \left(1 - \frac{2Gm_\mu}{c^2 r_\mu}\right) dt^2 - \left(\sum_{\mu=1}^m \left(1 - \frac{2Gm_\mu}{c^2 r_\mu}\right)^{-1}\right) dr_\mu^2 - \sum_{\mu=1}^m r_\mu^2 (d\theta_\mu^2 + \sin^2 \theta_\mu d\phi^2).$$

**Case 3.**  $\widehat{m} = 3$ , i.e.,  $t_\mu = t$ ,  $r_\mu = r$  and  $\theta_\mu = \theta$ , or  $t_\mu = t$ ,  $r_\mu = r$  and  $\phi_\mu = \phi$ , or or  $t_\mu = t$ ,

$\theta_\mu = \theta$  and  $\phi_\mu = \phi$  for  $1 \leq \mu \leq m$ .

We consider three subcases following.

**Subcase 3.1.**  $t_\mu = t$ ,  $r_\mu = r$  and  $\theta_\mu = \theta$ .

In this subcase, the combinatorial metric is

$$ds^2 = \sum_{\mu=1}^m \left(1 - \frac{2Gm_\mu}{c^2 r}\right) dt^2 - \sum_{\mu=1}^m \left(1 - \frac{2Gm_\mu}{c^2 r}\right)^{-1} dr^2 - mr^2 d\theta^2 - r^2 \sin^2 \theta \sum_{\mu=1}^m d\phi_\mu^2.$$

**Subcase 3.2.**  $t_\mu = t$ ,  $r_\mu = r$  and  $\phi_\mu = \phi$ .

In this subcase, the combinatorial metric is

$$ds^2 = \sum_{\mu=1}^m \left(1 - \frac{2Gm_\mu}{c^2 r}\right) dt^2 - \sum_{\mu=1}^m \left(1 - \frac{2Gm_\mu}{c^2 r}\right)^{-1} dr^2 - r^2 \sum_{\mu=1}^m (d\theta_\mu^2 + \sin^2 \theta_\mu d\phi^2).$$

These subcases 3.1 and 3.2 can be only happen if the centers of these  $m$  fields are at a same point  $O$  in a space.

**Subcase 3.3.**  $t_\mu = t$ ,  $\theta_\mu = \theta$  and  $\phi_\mu = \phi$ .

In this subcase, the combinatorial metric is

$$ds^2 = \sum_{\mu=1}^m \left(1 - \frac{2Gm_\mu}{c^2 r_\mu}\right) dt^2 - \sum_{\mu=1}^m \left(1 - \frac{2Gm_\mu}{c^2 r_\mu}\right)^{-1} dr_\mu^2 - \sum_{\mu=1}^m r_\mu (d\theta^2 + \sin^2 \theta d\phi^2).$$

**Case 4.**  $\hat{m} = 4$ , i.e.,  $t_\mu = t$ ,  $r_\mu = r$ ,  $\theta_\mu = \theta$  and  $\phi_\mu = \phi$  for  $1 \leq \mu \leq m$ .

In this subcase, the combinatorial metric is

$$ds^2 = \sum_{\mu=1}^m \left(1 - \frac{2Gm_\mu}{c^2 r}\right) dt^2 - \sum_{\mu=1}^m \left(1 - \frac{2Gm_\mu}{c^2 r}\right)^{-1} dr^2 - mr^2 (d\theta^2 + \sin^2 \theta d\phi^2).$$

Particularly, if  $m_\mu = M$  for  $1 \leq \mu \leq m$ , we get that

$$ds^2 = \left(1 - \frac{2GM}{c^2 r}\right) m dt^2 - \left(1 - \frac{2GM}{c^2 r}\right)^{-1} m dr^2 - mr^2 (d\theta^2 + \sin^2 \theta d\phi^2).$$

Define a coordinate transformation

$$(t, r, \theta, \phi) \rightarrow ({}_s t, {}_s r, {}_s \theta, {}_s \phi) = (t\sqrt{m}, r\sqrt{m}, \theta, \phi).$$

Then the previous formula turns to

$$ds^2 = \left(1 - \frac{2GM}{c^2 r}\right) d_s t^2 - \frac{d_s r^2}{1 - \frac{2GM}{c^2 r}} - {}_s r^2 (d_s \theta^2 + \sin^2 {}_s \theta d_s \phi^2)$$

in this new coordinate system  $({}_s t, {}_s r, {}_s \theta, {}_s \phi)$ , whose geometrical behavior likes that of the

gravitational field.

### 3.4 Combinatorial Reissner-Nordström Metric

The Schwarzschild metric is a spherically symmetric solution of the Einstein's gravitational equations in conditions  $\mathcal{E}_{(\mu\nu)(\sigma\tau)} = 0$ . In some special cases, we can also find their solutions for the case  $\mathcal{E}_{(\mu\nu)(\sigma\tau)} \neq 0$ . The *Reissner-Nordström metric* is such a case with

$$\mathcal{E}_{(\mu\nu)(\sigma\tau)} = \frac{1}{4\pi} \left( \frac{1}{4} g_{\mu\nu} F_{\alpha\beta} F^{\alpha\beta} - F_{\mu\alpha} F_{\nu}^{\alpha} \right)$$

in the Maxwell field with total mass  $m$  and total charge  $e$ , where  $F_{\alpha\beta}$  and  $F^{\alpha\beta}$  are given in Subsection 7.3.4. Its metrics takes the following form:

$$g_{\mu\nu} = \begin{bmatrix} x_{11} & 0 & 0 & 0 \\ 0 & x_{22} & 0 & 0 \\ 0 & 0 & -r^2 & 0 \\ 0 & 0 & 0 & -r^2 \sin^2 \theta \end{bmatrix},$$

where  $r_s = 2Gm/c^2$ ,  $r_e^2 = 4G\pi e^2/c^4$ ,  $x_{11} = 1 - \frac{r_s}{r} + \frac{r_e^2}{r^2}$  and  $x_{22} = -\left(1 - \frac{r_s}{r} + \frac{r_e^2}{r^2}\right)^{-1}$ . In this case, its line element  $ds$  is given by

$$ds^2 = \left(1 - \frac{r_s}{r} + \frac{r_e^2}{r^2}\right) dt^2 - \left(1 - \frac{r_s}{r} + \frac{r_e^2}{r^2}\right)^{-1} dr^2 - r^2(d\theta^2 + \sin^2 \theta d\phi^2). \quad (3 - 5)$$

Obviously, if  $e = 0$ , i.e., there are no charges in the gravitational field, then the equations (3 - 5) turns to that of the Schwarzschild metric (3 - 4).

Now let  $(\mathcal{C}_G|\bar{t})$  be a combinatorial field of charged gravitational fields  $M_1, M_2, \dots, M_m$  with masses  $m_1, m_2, \dots, m_m$  and charges  $e_1, e_2, \dots, e_m$ , respectively. Similar to the case of Schwarzschild metric, we consider the case of  $n_\mu = 4$  for  $1 \leq \mu \leq m$ . We establish  $m$  spherical coordinate subframe  $(t_\mu; r_\mu, \theta_\mu, \phi_\mu)$  with its originality at the center of such a mass space. Then we know its a spherically symmetric solution by (3 - 5) to be

$$ds_\mu^2 = \left(1 - \frac{r_{\mu s}}{r_\mu} + \frac{r_{\mu e}^2}{r_\mu^2}\right) dt_\mu^2 - \left(1 - \frac{r_{\mu s}}{r_\mu} + \frac{r_{\mu e}^2}{r_\mu^2}\right)^{-1} dr_\mu^2 - r_\mu^2(d\theta_\mu^2 + \sin^2 \theta_\mu d\phi_\mu^2).$$

Likewise the case of Schwarzschild metric, we consider combinatorial fields of charged gravitational fields dependent on the intersection dimension  $\hat{m}$  following.

**Case 1.**  $\hat{m} = 1$ , i.e.,  $t_\mu = t$  for  $1 \leq \mu \leq m$ .

In this case, by applying Theorem 3.1 we get the combinatorial metric

$$ds^2 = \sum_{\mu=1}^m \left(1 - \frac{r_{\mu s}}{r_\mu} + \frac{r_{\mu e}^2}{r_\mu^2}\right) dt^2 - \sum_{\mu=1}^m \left(1 - \frac{r_{\mu s}}{r_\mu} + \frac{r_{\mu e}^2}{r_\mu^2}\right)^{-1} dr_\mu^2 - \sum_{\mu=1}^m r_\mu^2(d\theta_\mu^2 + \sin^2 \theta_\mu d\phi_\mu^2).$$

**Case 2.**  $\hat{m} = 2$ , i.e.,  $t_\mu = t$  and  $r_\mu = r$ , or  $t_\mu = t$  and  $\theta_\mu = \theta$ , or  $t_\mu = t$  and  $\phi_\mu = \phi$  for  $1 \leq \mu \leq m$ .

Consider the following three subcases.

**Subcase 2.1.**  $t_\mu = t$ ,  $r_\mu = r$ .

In this subcase, the combinatorial metric is

$$ds^2 = \sum_{\mu=1}^m \left(1 - \frac{r_{\mu s}}{r} + \frac{r_{\mu e}^2}{r^2}\right) dt^2 - \sum_{\mu=1}^m \left(1 - \frac{r_{\mu s}}{r} + \frac{r_{\mu e}^2}{r^2}\right)^{-1} dr^2 - \sum_{\mu=1}^m r^2 (d\theta_\mu^2 + \sin^2 \theta_\mu d\phi_\mu^2),$$

which can only happens if these  $m$  fields are at a same point  $O$  in a space. Particularly, if  $m_\mu = M$  and  $e_\mu = e$  for  $1 \leq \mu \leq m$ , we find that

$$ds^2 = \left(1 - \frac{2GM}{c^2 r} + \frac{4\pi G e^4}{c^4 r^2}\right) m dt^2 - \frac{m dr^2}{1 - \frac{2GM}{c^2 r} + \frac{4\pi G e^4}{c^4 r^2}} - \sum_{\mu=1}^m r^2 (d\theta_\mu^2 + \sin^2 \theta_\mu d\phi_\mu^2).$$

**Subcase 2.2.**  $t_\mu = t$ ,  $\theta_\mu = \theta$ .

In this subcase, by applying Theorem 3.1 we know that the combinatorial metric is

$$ds^2 = \sum_{\mu=1}^m \left(1 - \frac{r_{\mu s}}{r_\mu} + \frac{r_{\mu e}^2}{r_\mu^2}\right) dt^2 - \sum_{\mu=1}^m \left(1 - \frac{r_{\mu s}}{r_\mu} + \frac{r_{\mu e}^2}{r_\mu^2}\right)^{-1} dr_\mu^2 - \sum_{\mu=1}^m r_\mu^2 (d\theta^2 + \sin^2 \theta d\phi_\mu^2).$$

**Subcase 2.3.**  $t_\mu = t$ ,  $\phi_\mu = \phi$ .

In this subcase, we know that the combinatorial metric is

$$ds^2 = \sum_{\mu=1}^m \left(1 - \frac{r_{\mu s}}{r_\mu} + \frac{r_{\mu e}^2}{r_\mu^2}\right) dt^2 - \sum_{\mu=1}^m \left(1 - \frac{r_{\mu s}}{r_\mu} + \frac{r_{\mu e}^2}{r_\mu^2}\right)^{-1} dr_\mu^2 - \sum_{\mu=1}^m r_\mu^2 (d\theta_\mu^2 + \sin^2 \theta_\mu d\phi^2).$$

**Case 3.**  $\hat{m} = 3$ , i.e.,  $t_\mu = t$ ,  $r_\mu = r$  and  $\theta_\mu = \theta$ , or  $t_\mu = t$ ,  $r_\mu = r$  and  $\phi_\mu = \phi$ , or or  $t_\mu = t$ ,  $\theta_\mu = \theta$  and  $\phi_\mu = \phi$  for  $1 \leq \mu \leq m$ .

We consider three subcases following.

**Subcase 3.1.**  $t_\mu = t$ ,  $r_\mu = r$  and  $\theta_\mu = \theta$ .

In this subcase, by applying Theorem 3.1 we obtain that the combinatorial metric is

$$ds^2 = \sum_{\mu=1}^m \left(1 - \frac{r_{\mu s}}{r} + \frac{r_{\mu e}^2}{r^2}\right) dt^2 - \sum_{\mu=1}^m \left(1 - \frac{r_{\mu s}}{r} + \frac{r_{\mu e}^2}{r^2}\right)^{-1} dr^2 - \sum_{\mu=1}^m r^2 (d\theta^2 + \sin^2 \theta d\phi_\mu^2).$$

Particularly, if  $m_\mu = M$  and  $e_\mu = e$  for  $1 \leq \mu \leq m$ , then we get that

$$ds^2 = \left(1 - \frac{2GM}{c^2 r} + \frac{4\pi G e^4}{c^4 r^2}\right) m dt^2 - \frac{m dr^2}{1 - \frac{2GM}{c^2 r} + \frac{4\pi G e^4}{c^4 r^2}} - \sum_{\mu=1}^m r^2 (d\theta^2 + \sin^2 \theta d\phi_\mu^2).$$

**Subcase 3.2.**  $t_\mu = t$ ,  $r_\mu = r$  and  $\phi_\mu = \phi$ .

In this subcase, the combinatorial metric is

$$ds^2 = \sum_{\mu=1}^m \left( 1 - \frac{r_{\mu s}}{r} + \frac{r_{\mu e}^2}{r^2} \right) dt^2 - \sum_{\mu=1}^m \left( 1 - \frac{r_{\mu s}}{r} + \frac{r_{\mu e}^2}{r^2} \right)^{-1} dr^2 - \sum_{\mu=1}^m r^2 (d\theta_\mu^2 + \sin^2 \theta_\mu d\phi^2).$$

Particularly, if  $m_\mu = M$  and  $e_\mu = e$  for  $1 \leq \mu \leq m$ , then we get that

$$ds^2 = \left( 1 - \frac{2GM}{c^2 r} + \frac{4\pi G e^4}{c^4 r^2} \right) m dt^2 - \frac{m dr^2}{1 - \frac{2GM}{c^2 r} + \frac{4\pi G e^4}{c^4 r^2}} - \sum_{\mu=1}^m r^2 (d\theta_\mu^2 + \sin^2 \theta_\mu d\phi^2).$$

**Subcase 3.3.**  $t_\mu = t$ ,  $\theta_\mu = \theta$  and  $\phi_\mu = \phi$ .

In this subcase, the combinatorial metric is

$$ds^2 = \sum_{\mu=1}^m \left( 1 - \frac{r_{\mu s}}{r_\mu} + \frac{r_{\mu e}^2}{r_\mu^2} \right) dt^2 - \sum_{\mu=1}^m \left( 1 - \frac{r_{\mu s}}{r_\mu} + \frac{r_{\mu e}^2}{r_\mu^2} \right)^{-1} dr_\mu^2 - \sum_{\mu=1}^m r_\mu^2 (d\theta^2 + \sin^2 \theta d\phi^2).$$

**Case 4.**  $\hat{m} = 4$ , i.e.,  $t_\mu = t$ ,  $r_\mu = r$ ,  $\theta_\mu = \theta$  and  $\phi_\mu = \phi$  for  $1 \leq \mu \leq m$ .

In this subcase, the combinatorial metric is

$$ds^2 = \sum_{\mu=1}^m \left( 1 - \frac{r_{\mu s}}{r} + \frac{r_{\mu e}^2}{r^2} \right) dt^2 - \sum_{\mu=1}^m \left( 1 - \frac{r_{\mu s}}{r} + \frac{r_{\mu e}^2}{r^2} \right)^{-1} dr^2 - m r^2 (d\theta^2 + \sin^2 \theta d\phi^2).$$

Furthermore, if  $m_\mu = M$  and  $e_\mu = e$  for  $1 \leq \mu \leq m$ , we obtain that

$$ds^2 = \left( 1 - \frac{2GM}{c^2 r} + \frac{4\pi G e^4}{c^4 r^2} \right) m dt^2 - \frac{m dr^2}{1 - \frac{2GM}{c^2 r} + \frac{4\pi G e^4}{c^4 r^2}} - m r^2 (d\theta^2 + \sin^2 \theta d\phi^2).$$

Similarly, we define the coordinate transformation

$$(t, r, \theta, \phi) \rightarrow ({}_s t, {}_s r, {}_s \theta, {}_s \phi) = (t\sqrt{m}, r\sqrt{m}, \theta, \phi).$$

Then the previous formula turns to

$$ds^2 = \left( 1 - \frac{2GM}{c^2 r} + \frac{4\pi G e^4}{c^4 r^2} \right) d{}_s t^2 - \frac{d{}_s r^2}{1 - \frac{2GM}{c^2 r} + \frac{4\pi G e^4}{c^4 r^2}} - {}_s r^2 (d{}_s \theta^2 + \sin^2 {}_s \theta d{}_s \phi^2)$$

in this new coordinate system  $({}_s t, {}_s r, {}_s \theta, {}_s \phi)$ , whose geometrical behavior likes a charged gravitational field.

#### §4. Multi-Time System

A *multi-time system* is such a combinatorial field  $(\mathcal{C}_G | \bar{t})$  consisting of fields  $M_1, M_2, \dots, M_m$

on reference frames

$$(t_1, r_1, \theta_1, \phi_1), \dots, (t_m, r_m, \theta_m, \phi_m),$$

and there are always exist two integers  $\kappa, \lambda, 1 \leq \kappa \neq \lambda \leq m$  such that  $t_\kappa \neq t_\lambda$ . Notice that these combinatorial fields discussed in Section 3 are all with  $t_\mu = t$  for  $1 \leq \mu \leq m$ , i.e., we can establish a time variable  $t$  for all fields in this combinatorial field. But if we can not determine all the behavior of living things in the Universe implied in the *weak anthropic principle*, we can not find such a time variable  $t$  for all fields. If so, we need a multi-time system for describing the Universe.

Among these multi-time systems, an interesting case appears in  $\widehat{m} = 3, r_\mu = r, \theta_\mu = \theta, \phi_\mu = \phi$ , i.e., beings live in the same dimensional 3 space, but with different notions on the time. Applying Theorem 3.1, we discuss the Schwarzschild and Reissner-Nordström metrics following.

#### 4.1 Schwarzschild Multi-Time System

In this case, the combinatorial metric is

$$ds^2 = \sum_{\mu=1}^m \left(1 - \frac{2Gm_\mu}{c^2 r}\right) dt_\mu^2 - \sum_{\mu=1}^m \left(1 - \frac{2Gm_\mu}{c^2 r}\right)^{-1} dr^2 - mr^2(d\theta^2 + \sin^2 \theta d\phi^2).$$

Applying the projective principle to this equation, we get metrics on gravitational fields  $M_1, M_2, \dots, M_m$  following:

$$ds_1^2 = \left(1 - \frac{2Gm_1}{c^2 r}\right) dt_1^2 - \left(1 - \frac{2Gm_1}{c^2 r}\right)^{-1} dr^2 - r^2(d\theta^2 + \sin^2 \theta d\phi^2),$$

$$ds_2^2 = \left(1 - \frac{2Gm_2}{c^2 r}\right) dt_2^2 - \left(1 - \frac{2Gm_2}{c^2 r}\right)^{-1} dr^2 - r^2(d\theta^2 + \sin^2 \theta d\phi^2),$$

.....,

$$ds_m^2 = \left(1 - \frac{2Gm_m}{c^2 r}\right) dt_m^2 - \left(1 - \frac{2Gm_m}{c^2 r}\right)^{-1} dr^2 - r^2(d\theta^2 + \sin^2 \theta d\phi^2),$$

Particularly, if  $m_\mu = M$  for  $1 \leq \mu \leq m$ , we then get that

$$ds^2 = \left(1 - \frac{2GM}{c^2 r}\right) \sum_{\mu=1}^m dt_\mu^2 - \left(1 - \frac{2GM}{c^2 r}\right)^{-1} mdr^2 - mr^2(d\theta^2 + \sin^2 \theta d\phi^2).$$

Its projection on the gravitational field  $M_\mu$  is

$$ds_\mu^2 = \left(1 - \frac{2GM}{c^2 r}\right) dt_\mu^2 - \left(1 - \frac{2GM}{c^2 r}\right)^{-1} dr^2 - r^2(d\theta^2 + \sin^2 \theta d\phi^2),$$



i.e., the Schwarzschild metric on  $M_\mu$ ,  $1 \leq \mu \leq m$ .

**4.2 Reissner-Nordström Multi-Time System**

In this case, the combinatorial metric is

$$ds^2 = \sum_{\mu=1}^m \left( 1 - \frac{2Gm_\mu}{c^2r} + \frac{4\pi Ge_\mu^4}{c^4r^2} \right) dt_\mu^2 - \sum_{\mu=1}^m \left( 1 - \frac{2Gm_\mu}{c^2r} + \frac{4\pi Ge_\mu^4}{c^4r^2} \right)^{-1} dr^2 - mr^2(d\theta^2 + \sin^2 \theta d\phi^2).$$

Similarly, by the projective principle we obtain the metrics on charged gravitational fields  $M_1, M_2, \dots, M_m$  following.

$$ds_1^2 = \left( 1 - \frac{2Gm_1}{c^2r} + \frac{4\pi Ge_1^4}{c^4r^2} \right) dt_1^2 - \left( 1 - \frac{2Gm_1}{c^2r} + \frac{4\pi Ge_1^4}{c^4r^2} \right)^{-1} dr^2 - r^2(d\theta^2 + \sin^2 \theta d\phi^2),$$

$$ds_2^2 = \left( 1 - \frac{2Gm_2}{c^2r} + \frac{4\pi Ge_2^4}{c^4r^2} \right) dt_2^2 - \left( 1 - \frac{2Gm_2}{c^2r} + \frac{4\pi Ge_2^4}{c^4r^2} \right)^{-1} dr^2 - r^2(d\theta^2 + \sin^2 \theta d\phi^2),$$

..... ,

$$ds_m^2 = \left( 1 - \frac{2Gm_m}{c^2r} + \frac{4\pi Ge_m^4}{c^4r^2} \right) dt_m^2 - \left( 1 - \frac{2Gm_m}{c^2r} + \frac{4\pi Ge_m^4}{c^4r^2} \right)^{-1} dr^2 - r^2(d\theta^2 + \sin^2 \theta d\phi^2),$$

Furthermore, if  $m_\mu = M$  and  $e_\mu = e$  for  $1 \leq \mu \leq m$ , we obtain that

$$ds^2 = \left( 1 - \frac{2GM}{c^2r} + \frac{4\pi Ge^4}{c^4r^2} \right) \sum_{\mu=1}^m dt_\mu^2 - \left( 1 - \frac{2GM}{c^2r} + \frac{4\pi Ge^4}{c^4r^2} \right)^{-1} mdr^2 - mr^2(d\theta^2 + \sin^2 \theta d\phi^2).$$

Its projection on the charged gravitational field  $M_\mu$  is

$$ds_\mu^2 = \left( 1 - \frac{2GM}{c^2r} + \frac{4\pi Ge^4}{c^4r^2} \right) dt_\mu^2 \left( 1 - \frac{2GM}{c^2r} + \frac{4\pi Ge^4}{c^4r^2} \right)^{-1} dr^2 - r^2(d\theta^2 + \sin^2 \theta d\phi^2)$$

i.e., the Reissner-Nordström metric on  $M_\mu$ ,  $1 \leq \mu \leq m$ .

As a by-product, these calculations and formulas mean that these beings with time notion different from that of human beings will recognize differently the structure of our universe if these beings are intellectual enough to do so.

**§5. Discussions**

**5.1 Geometrical Structure**

A simple calculation shows that the dimension of the combinatorial gravitational field ( $\mathcal{C}|\bar{t}$ ) in

Section 3 is

$$\dim(\mathcal{C}|\bar{t}) = 4m + (1 - m)\hat{m}. \quad (5 - 1)$$

For example,  $\dim(\mathcal{C}|\bar{t}) = 7, 10, 13, 16$  if  $\hat{m} = 1$  and  $6, 8, 10$  if  $\hat{m} = 1$  for  $m = 2, 3, 4$ . In this subsection, we analyze these geometrical structures with metrics appeared in Section 3.

As we have said in Section 1, the visible geometry is the spherical geometry of dimensional 3. That is why the sky looks like a spherical surface. In this geometry, we can only see the images of bodies with  $\dim \geq 3$  on our spherical surface( see [1]-[2] and [4] in details). But the situation is a little difference from that of the transferring information, which is transferred in all possible routes. In other words, a geometry of dimensional  $\geq 1$ . Therefore, not all information transferring can be seen by our eyes. But some of them can be felt by our six organs with the help of apparatus if needed. For example, the *magnetism* or *electromagnetism* can be only detected by apparatus. These notions enable us to explain the geometrical structures in combinatorial gravitational fields, for example, the Schwarzschild or Reissner-Nordström metrics.

**Case 1.**  $\hat{m} = 4$ .

In this case, by the formula (5 - 1) we get  $\dim(\mathcal{C}|\bar{t}) = 4$ , i.e., all fields  $M_1, M_2, \dots, M_m$  are in  $\mathbf{R}^4$ , which is the most enjoyed case by human beings. We have gotten the Schwarzschild metric

$$ds^2 = \sum_{\mu=1}^m \left(1 - \frac{2Gm_{\mu}}{c^2 r}\right) dt^2 - \sum_{\mu=1}^m \left(1 - \frac{2Gm_{\mu}}{c^2 r}\right)^{-1} dr^2 - mr^2(d\theta^2 + \sin^2 \theta d\phi^2)$$

or the Reissner-Nordström metric

$$ds^2 = \sum_{\mu=1}^m \left(1 - \frac{r_{\mu s}}{r} + \frac{r_{\mu e}^2}{r^2}\right) dt^2 - \frac{dr^2}{\sum_{\mu=1}^m \left(1 - \frac{r_{\mu s}}{r} + \frac{r_{\mu e}^2}{r^2}\right)} - mr^2(d\theta^2 + \sin^2 \theta d\phi^2)$$

for non-charged or charged combinatorial gravitational fields in vacuum in Sections 3. If it is so, the behavior of Universe can be realized finally by human beings. This also means that the discover of science will be ended, i.e., we can established the *Theory of Everything* finally for the Universe.

**Case 2.**  $\hat{m} \leq 3$ .

If the Universe is so, then  $\dim(\mathcal{C}|\bar{t}) \geq 5$ . In this case, we know the combinatorial Schwarzschild metrics and combinatorial Reissner-Nordström metrics in Section 3, for example, if  $t_{\mu} = t$ ,  $r_{\mu} = r$  and  $\phi_{\mu} = \phi$ , the combinatorial Schwarzschild metric is

$$ds^2 = \sum_{\mu=1}^m \left(1 - \frac{r_{\mu s}}{r}\right) dt^2 - \sum_{\mu=1}^m \frac{dr^2}{\left(1 - \frac{r_{\mu s}}{r}\right)} - \sum_{\mu=1}^m r^2(d\theta_{\mu}^2 + \sin^2 \theta_{\mu} d\phi^2)$$

and the combinatorial Reissner-Nordström metric is

$$ds^2 = \sum_{\mu=1}^m \left( 1 - \frac{r_{\mu s}}{r} + \frac{r_{\mu e}^2}{r^2} \right) dt^2 - \sum_{\mu=1}^m \frac{dr^2}{\left( 1 - \frac{r_{\mu s}}{r} + \frac{r_{\mu e}^2}{r^2} \right)} - \sum_{\mu=1}^m r^2 (d\theta_\mu^2 + \sin^2 \theta_\mu d\phi^2).$$

Particularly, if  $m_\mu = M$  and  $e_\mu = e$  for  $1 \leq \mu \leq m$ , then we get that

$$ds^2 = \left( 1 - \frac{2GM}{c^2 r} \right) m dt^2 - \frac{m dr^2}{\left( 1 - \frac{2GM}{c^2 r} \right)} - \sum_{\mu=1}^m r^2 (d\theta_\mu^2 + \sin^2 \theta_\mu d\phi^2)$$

for combinatorial gravitational field and

$$ds^2 = \left( 1 - \frac{2GM}{c^2 r} + \frac{4\pi G e^4}{c^4 r^2} \right) m dt^2 - \frac{m dr^2}{\left( 1 - \frac{2GM}{c^2 r} + \frac{4\pi G e^4}{c^4 r^2} \right)} - \sum_{\mu=1}^m r^2 (d\theta_\mu^2 + \sin^2 \theta_\mu d\phi^2)$$

for charged combinatorial gravitational field in vacuum. In this case, the observed interval in the field  $M_O$  where human beings live is

$$ds_O = a(t, r, \theta, \phi) dt^2 - b(t, r, \theta, \phi) dr^2 - c(t, r, \theta, \phi) d\theta^2 - d(t, r, \theta, \phi) d\phi^2.$$

Then *how to we explain the differences  $ds - ds_O$  in physics?* Notice that we can only observe the line element  $ds_O$ , a projection of  $ds$  on  $M_O$ . Whence, all contributions in  $ds - ds_O$  come from the spatial direction not observable by human beings. In this case, we are difficult to determine the exact behavior. Furthermore, if  $\hat{m} \leq 3$  holds, because there are infinite combinations ( $\mathcal{C}_G|\bar{t}$ ) of existent fields underlying a connected graph  $G$ , we can not find an ultimate theory for the Universe, i.e., there are no a *Theory of Everything* for the Universe and the science established by ours is approximate, holds on conditions and the discover of science will be endless forever.

## 5.2 Physical Formation

A generally accepted notion on the formation of Universe is the Big Bang theory ([24]), i.e., the origin of Universe is from an exploded at a singular point on its beginning. Notice that the geometry in the Big Bang theory is just a Euclidean  $\mathbf{R}^3$  geometry, i.e., a visible geometry by human beings. Then *how is it came into being for a combinatorial spacetime? Weather it is contradicts to the experimental data?* We will explain these questions following.

**Realization 5.1** *Any combinatorial spacetime was formed by  $|G|$  times Big Bang in an early space.*

Certainly, if there is just one time Big Bang, then there exists one spacetime observed by us, not a multiple or combinatorial spacetime. But there are no arguments for this claim. It is only an assumption on the origin of Universe. If it is not exploded in one time, but in  $m \geq 2$  times in different spatial directions, *what will happens for the structure of spacetime?*

The process of Big Bang model can be applied for explaining the formation of combinatorial spacetimes. Assume the dimension of original space is bigger enough and there are  $m$  explosions

for the origin of Universe. Then likewise the standard process of Big Bang, each time of Big Bang brought a spacetime. After the  $m$  Big Bangs, we finally get a multi-spacetime underlying a combinatorial structure, i.e., a combinatorial spacetime  $(\mathcal{C}_G|\bar{t})$  with  $|G| = m$ , such as those shown in Fig.3 for  $G = C_4$  or  $K_3$ .

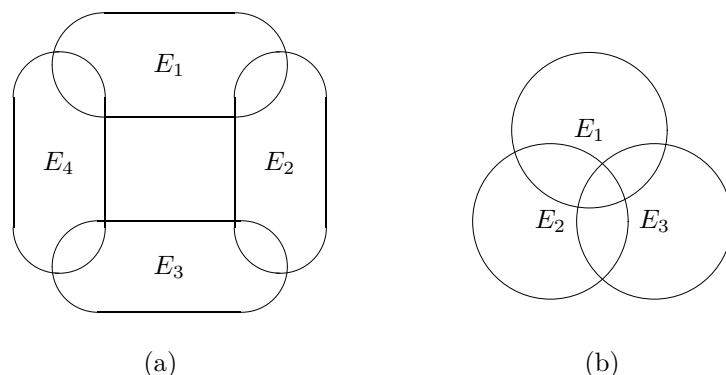

**Fig.3**

where  $E_i$  denotes  $i^{\text{th}}$  time explosion for  $1 \leq i \leq 4$ . In the process of  $m$  Big Bangs, we do not assume that each explosion  $E_i$ ,  $1 \leq i \leq m$  was happened in a Euclidean space  $\mathbf{R}^3$ , but in  $\mathbf{R}^n$  for  $n \geq 3$ . Whence, the intersection  $E_i \cap E_j$  means the same spatial directions in explosions  $E_i$  and  $E_j$  for  $1 \leq i, j \leq m$ . Whence, information in  $E_i$  or  $E_j$  appeared along directions in  $E_i \cap E_j$  will both be reflected in  $E_j$  or  $E_i$ . As we have said in Subsection 5.1, if  $\dim E_i \cap E_j \leq 2$ , then such information can not be seen by us but only can be detected by apparatus, such as those of the *magnetism* or *electromagnetism*.

**Realization 5.2** *The spacetime lived by us is an intersection of other spacetimes.*

This fact is an immediately conclusion of Realization 5.1.

**Realization 5.3** *Each experimental data on Universe obtained by human beings is synthesized, not be in one of its spacetimes.*

Today, we have known a few datum on the Universe by COBE or WMAP. In these data, the one well-known is the  $2.7^\circ\text{K}$  cosmic microwave background radiation. Generally, this data is thought to be an evidence of Big Bang theory. If the Universe is a combinatorial one, *how to we explain it?* First, the  $2.7^\circ\text{K}$  is not contributed by one Big Bang in  $\mathbf{R}^3$ , but by many times before 137 light years, i.e., it is a synthesized data. Second, the  $2.7^\circ\text{K}$  is surveyed by WMAP, an explorer satellite in  $\mathbf{R}^3$ . By the projective principle in Section 3, it is only a projection of the cosmic microwave background radiation in the Universe on the space  $\mathbf{R}^3$  lived by us. In fact, all datum on the Universe surveyed by human beings can be explained in such a way. So there are no contradiction between combinatorial model and datum on the Universe already known by us, but it reflects a combinatorial behavior of the Universe.

## References

- [1] G.Belot, Remarks on the geometry of visibles, *Philosophical Quarterly*, 53(2003), 581-586.
- [2] T.Reid, An inquiry into the human mind on the principles of common sense, in D.Brookes ed., Edinburgh University Press, 1997.
- [3] Y.V.Shtanov, On brane-world cosmology, arXiv: hep-th/0005193.
- [4] G.Yaffe, Reconsidering Reid's geometry of visibles', *Philosophical Quarterly*, 52(2002), 602-620.
- [5] L.F.Mao, Geometrical theory on combinatorial manifolds, *JP J.Geometry and Topology*, Vol.7, No.1(2007),65-114.
- [6] L.F.Mao, An introduction to Smarandache multi-spaces and mathematical combinatorics, *Scientia Magna*, Vol.3, No.1(2007), 54-80.
- [7] L.F.Mao, Curvature equations on combinatorial manifolds with applications to theoretical physics, *International J.Mathematical Combinatorics*, Vol.1(2008), Vol.1, 1-25.  
[8]L.F.Mao, Combinatorially Riemannian submanifolds, *International J. Mathematical Combinatorics*, Vol.1(2008), Vol.2, 1-25.
- [9] L.F.Mao, Combinatorial fields-an introduction, *International J. Mathematical Combinatorics*, Vol.1(2009), Vol.3, 1-22.
- [10] Dmitri Rabounski, Smarandache spaces as a new extension of the basic space-time of general relativity, *Progress in Physics*, Vol.2,2010, L1-L2.
- [11] F.Smarandache, Mixed noneuclidean geometries, eprint *arXiv: math/0010119*, 10/2000.
- [12] G.W.Moorw, what is a brane? *Notices of the AMS*, Vol.52, 2(2005), 214-215.
- [13] Max Tegmark, Parallel universes, in J.D.Barrow, P.C.W.Davies and C.L.Harper eds., *Science and Ultimate Reality: From Quantum to Cosmos*, Cambridge University Press, 2003.
- [14] U.Gunther and A.Zhuk, Phenomenology of brane-world cosmological models, ArXiv: gr-qc/0410130.
- [15] D.Ida, Brane-world cosmology, ArXiv: gr-qc/9912002.
- [16] P.Kanti, R.Madden and K.A.Olive, A 6-d brane world model, ArXiv: hep-ph/0104177.
- [17] E.Papantonopoulos, Braneworld cosmological models, arXiv: gr-qc/0410032.
- [18] E.Papantonopoulos, Cosmology in six dimensions, arXiv: gr-qc/0601011.
- [19] T.X. Zhang, A new cosmological model: black hole universe, *Progress in Physics*, Vol.3(2009), 3-11.
- [20] L.F.Mao, *Combinatorial Geometry with Applications to Field Theory*, InfoQuest, USA, 2009.
- [21] L.F.Mao, A combinatorial decomposition of Euclidean spaces  $\mathbf{R}^n$  with contribution to visibility, *International J. Math. Combin.*, Vol.1, 2010, 47-64.
- [22] L.F.Mao, Lie multi-groups underlying graphs, Submitted.
- [23] L.F.Mao, Constructing principal fiber bundles by voltage assignment, Submitted.
- [24] John A. Peacock, *Cosmological Physics*, Cambridge University Press, 1999.

## Biological $n$ -System with Global Stability

**Abstract:** A food web on  $n$  living things  $x_1, x_2, \dots, x_n$ , i.e., a biological  $n$ -system can be mathematically characterized by action flow  $\vec{G}^L$  of order  $n$  with surplus flows of growth rates  $\dot{x}_i$  of population on vertices  $v_i$ , vector flow  $(x_i, x_j)$ , end-operators  $x_i f_{ij}, x_j f'_{ji}$  on edge  $(v_i, v_j)$ , where  $f_{ij}, f'_{ji}$  are 2 variable functions for integers  $1 \leq i, j \leq n$  holding with a system of conservation equations

$$\dot{x}_i = x_i \left( \sum_{v_k \in N^-(v_i)} f'_{ki}(x_k, x_i) - \sum_{v_l \in N^+(v_i)} f_{il}(x_i, x_l) \right), \quad 1 \leq i \leq n,$$

which is a system of  $n$  differential equations. Certainly,  $\mathbf{0} \in \mathbb{R}^n$  is one of its equilibrium points. But the system

$$\sum_{v_k \in N^-(v_i)} f'_{ki}(x_k, x_i) = \sum_{v_l \in N^+(v_i)} f_{il}(x_i, x_l), \quad 1 \leq i \leq n$$

of equations may be solvable or not. However, even if it is non-solvable, it characterizes biological systems also if it can be classified into solvable subsystems. The main purpose of this paper is to characterize the biological behavior of such systems with global stability by a combinatorial approach, i.e., establish the relationship between solvable subsystems of a biological  $n$ -system with Eulerian subgraphs of labeling bi-digraph of  $\vec{G}^L$ , characterize  $n$ -system with linear growth rate and the global stability on subgraphs, and interpret also the biological behavior of  $G^L$ -solutions of non-solvable equations, which opened a way for characterizing biological system with species more than 3, i.e., mathematical combinatorics. As we know, nearly all papers discussed biological system with species less or equal to 3 in the past decades.

**Key Words:** Food web, biological  $n$ -system, action flow, Klomogorov model, non-solvable system, Eulerian graph, bi-digraph, Smarandache multispace, mathematical combinatorics.

**AMS(2010):** 05C10, 05C21, 34D43, 92B05.

### §1. Introduction

There is a well-known biological law for living things in the natural world, i.e., the survival of the fittest in the natural selection because of the limited resources of foods. Thus, foods naturally result in connection with living things, i.e., *food chain*, a linear network starting from producer organisms and ending at apex predator species or decomposer species. And biologically, a *food web* is a natural interconnection of food chains, a resultant by a simple ruler ([28]), and generally a graphical representation of what-eats-what in the ecological community such as those shown in Fig.1 for 4 food chains: grass→ladybug→frog→snake→eagle, grass→ladybug→frog→egret, grass→rabbit→snake→eagle and grass→rabbit→eagle.

---

<sup>1</sup>An invited report at the *International Conference on Applications of Mathematics in Topological Dynamics, Physical, Biological and Chemical Systems*, December 9-11, 2016, India.

<sup>2</sup>*Bull. Cal. Math. Soc.*, 108, (6) 403-443 (2016)

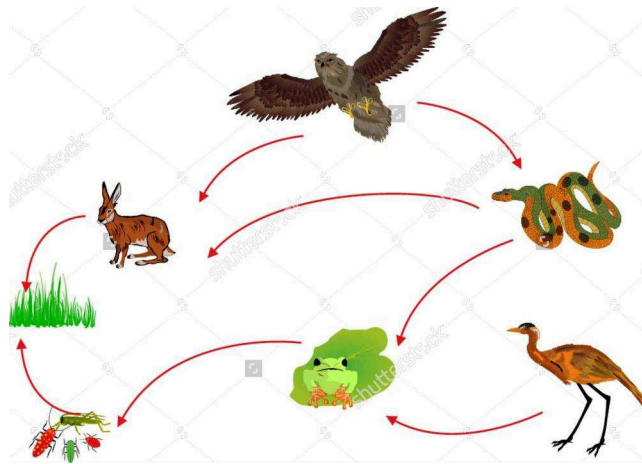

Fig.1

Actually, a food web is an interaction system in physics ([15]-[16], [25]) which can be mathematically characterized by the strength of what action on what. For a biological 2-system, let  $x, y$  be the two species with the action strength  $F'(x \rightarrow y), F(y \rightarrow x)$  of  $x$  to  $y$  and  $y$  to  $x$  on their growth rate, respectively ([21]). Then, such a system can be quantitatively characterized by differential equations

$$\begin{cases} \dot{x} = F(y \rightarrow x) \\ \dot{y} = F'(x \rightarrow y) \end{cases}$$

on the populations of species  $x$  and  $y$ .

Usually, we denote 2 competing things by a directed edge  $(u, v)$  labeling with vector flow  $(x, y)$  and end-operators  $F, F'$  respectively on its center and both ends, where  $F, F'$  are action operators with  $F(x \rightarrow 0) = F'(0 \rightarrow y) = 0$  if  $y = 0$  or  $x = 0$  and the growth rates  $\dot{x}, \dot{y}$  of populations on vertices, such as those shown in Fig.2. Particularly,  $F = xf, F' = yf'$  in the Kolmogorov model, where  $f, f'$  are 2 variable functions, and  $f = \lambda - by, f' = \mu + cx$  in the Lotka-Volterra model ([2], [20]).

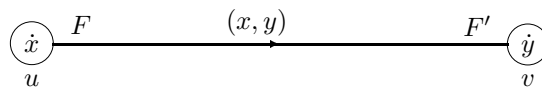

Fig.2

Then, a food web is nothing else but a topological digraph  $\vec{G}$ , a 2-tuple  $(V(\vec{G}), E(\vec{G}))$  with  $E(\vec{G}) \subset V(\vec{G}) \times V(\vec{G})$  and a labeling  $L : \vec{G} \rightarrow R \cup S$  on  $\vec{G}$  with  $L : V(\vec{G}) \rightarrow R$  and  $E(\vec{G}) \rightarrow S$ , where  $R$  and  $S$  are predetermined sets ([19]). Particularly, if  $R = \{\dot{x}, \dot{y}\}$ , the growth rates of populations and  $S = \{(F, (x, y), F')\}$ , a 3-tuple with action operator  $F$  on the initial,  $F'$  on the end and vector  $(x, y)$  on the middle of edge  $(u, v)$ , we get the biological 2-system shown in Fig.2.

However, the law of conservation of matter concludes that matter is neither created nor

destroyed in chemical reactions. In other words, the mass of any one element at the beginning of a reaction will equal to that of element at the end, i.e., the in and out-action must be conservative with the surplus on each vertex of  $\vec{G}^L$ . Thus, a food web is an *action flow* ([18]) further, i.e., a topological digraph  $\vec{G}^L$  labeled with surplus flows of growth rates  $\dot{x}_i$  of population on vertices  $v_i$ , vector flow  $(x_i, x_j)$ , initial and end operators  $F_{ij}, F'_{ij}$  on edge  $(v_i, v_j)$  for integers  $1 \leq i, j \leq n$ , where  $n \geq 2$  holding with a system of conservation equations

$$\dot{x}_i = \sum_{v_k \in N^-(v_i)} F'_{ki}(x_k \rightarrow x_i) - \sum_{v_l \in N^+(v_i)} F_{il}(x_i \rightarrow x_l), \quad 1 \leq i \leq n$$

and particularly,

$$\dot{x}_i = x_i \left( \sum_{v_k \in N^-(v_i)} f'_{ki}(x_k, x_i) - \sum_{v_l \in N^+(v_i)} f_{il}(x_i, x_l) \right), \quad 1 \leq i \leq n \tag{1.1}$$

in the *Kolmogorov model*. For example, a biological 4-system shown in Fig.3 is a system of 4 ordinary differential equations

$$\begin{cases} \dot{x}_1 = x_1 ((b_{52} - a_{11} - a_{12})x_1 - a_{12}x_2 - a_{22}x_3 + b_{51}x_4) \\ \dot{x}_2 = x_2 (b_{11}x_1 + (b_{12} + b_{62} - a_{31})x_2 - a_{32}x_3 + b_{61}x_4) \\ \dot{x}_3 = x_3 (b_{21}x_1 + b_{31}x_2 + (b_{22} + b_{32} - a_{41})x_3 - a_{42}x_4) \\ \dot{x}_4 = x_4 (b_{41}x_3 - a_{52}x_1 - a_{62}x_2 + (b_{42} - a_{51} - a_{61})x_4) \end{cases} \tag{1.2}$$

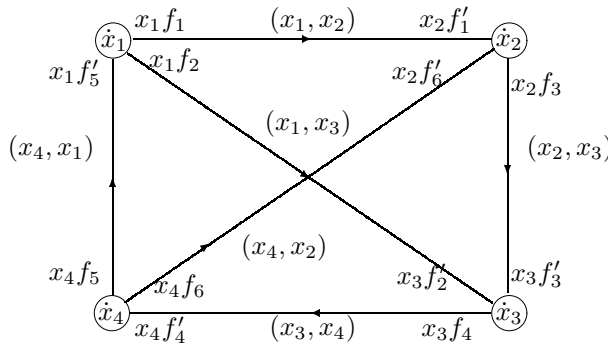

**Fig.3**

where,

$$\begin{aligned} f_1(x_1, x_2) &= a_{11}x_1 + a_{12}x_2, & f'_1(x_1, x_2) &= b_{11}x_1 + b_{12}x_2, \\ f_2(x_1, x_3) &= a_{21}x_1 + a_{22}x_3, & f'_2(x_1, x_3) &= b_{21}x_1 + b_{22}x_3, \\ f_3(x_2, x_3) &= a_{31}x_2 + a_{32}x_3, & f'_3(x_2, x_3) &= b_{31}x_2 + b_{32}x_3, \\ f_4(x_3, x_4) &= a_{41}x_3 + a_{42}x_4, & f'_4(x_3, x_4) &= b_{41}x_3 + b_{42}x_4, \\ f_5(x_4, x_1) &= a_{51}x_4 + a_{52}x_1, & f'_5(x_4, x_1) &= b_{51}x_4 + b_{52}x_1, \\ f_6(x_4, x_2) &= a_{61}x_4 + a_{62}x_2, & f'_6(x_4, x_2) &= b_{61}x_4 + b_{62}x_2. \end{aligned}$$



**Definition 1.1** Let  $\vec{G}^L$  be a labeling topological digraph. A subgraph  $\vec{H}$  of  $\vec{G}$  is said to be a labeling subgraph of  $\vec{G}^L$  if its vertices and edges are labeled by  $L|_H$ , denoted by  $\vec{H}^L \prec \vec{G}^L$  and furthermore, if  $\vec{H}^L = \vec{G}^L|_{V(H)}$ , such a labeling subgraph is said to be an induced subgraph of  $\vec{G}^L$ , denoted by  $\langle V(\vec{H}) \rangle_G$ .

For example, the 2 labeling graphs  $\vec{G}_1^L, \vec{G}_2^L$  in Fig.4 are all labeling subgraphs but only  $\vec{G}_1^L$  is an induced subgraph of the graph shown in Fig.3.

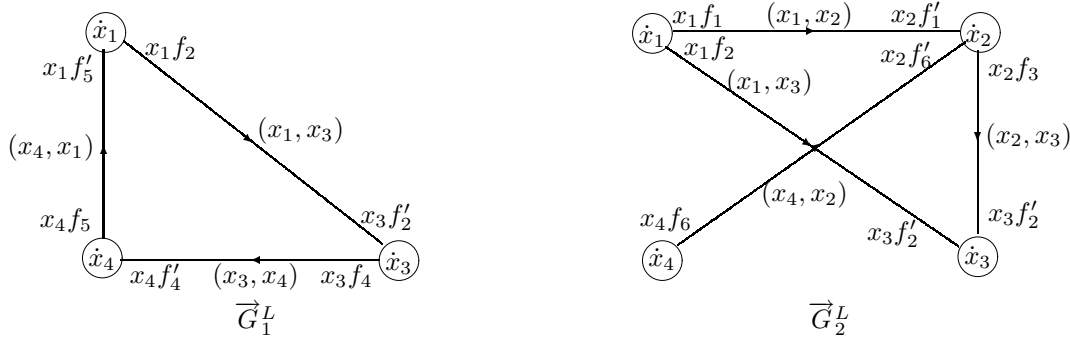

Fig.4

Clearly, a labeling subgraph of  $\vec{G}^L$  is also consisting of food chains but it maybe not a food web if it is not an action flow again. Even it is, the sizes of species are not the same as they in  $\vec{G}^L$  because the conservative laws are completely changed. For example, the system of conservation equations for the labeling subgraph  $\vec{G}_1^L$  is

$$\begin{cases} \dot{x}_1 = x_1 ((b_{51} - a_{21})x_1 - a_{22}x_3 + b_{51}x_4) \\ \dot{x}_3 = x_3 (b_{21}x_1 + (b_{22} - a_{41})x_3 - a_{42}x_4) \\ \dot{x}_4 = x_4 (b_{41}x_3 - a_{52}x_1 + (b_{42} - a_{51})x_4) \end{cases} \quad (1.3)$$

a very different system from that of (1.2).

The following terminologies are useful for characterizing food webs.

**Definition 1.2** Let  $\vec{G}$  be a digraph with  $\overleftarrow{G}$  a digraph reversing direction on every edge in  $\vec{G}$ . A bi-digraph of  $\vec{G}$  is defined by  $\vec{G} \cup \overleftarrow{G}$  and a labeling bi-digraph  $(\vec{G} \cup \overleftarrow{G})^{\hat{L}}$  of a labeling digraph  $\vec{G}^L$  is a labeling graph on  $\vec{G} \cup \overleftarrow{G}$  with a labeling  $\hat{L} : V(\vec{G} \cup \overleftarrow{G}) \rightarrow L(V(\vec{G}))$ ,  $\hat{L} : E(\vec{G} \cup \overleftarrow{G}) \rightarrow L(E(\vec{G} \cup \overleftarrow{G}))$  by  $\hat{L} : (u, v) \rightarrow \{0, (x, y), yf'\}$ ,  $(v, u) \rightarrow \{xf, (x, y), 0\}$  if  $L : (u, v) \rightarrow \{xf, (x, y), yf'\}$  for  $\forall (u, v) \in E(\vec{G})$ , such as those shown in Fig.5.

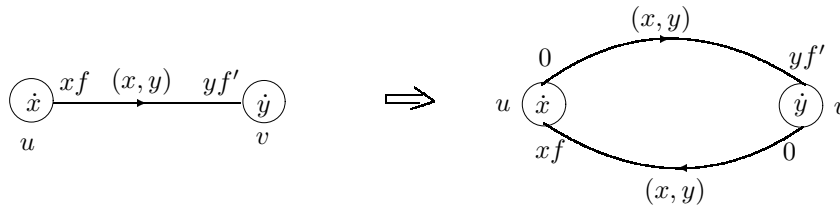

Fig.5

**Definition 1.3** A circuit in a digraph  $\vec{G}$  is a nontrivial closed trail with different edges in  $\vec{G}$  and an Eulerian circuit in digraph  $\vec{G}$  is a circuit of  $\vec{G}$  containing every edge of  $\vec{G}$ .

A digraph  $\vec{G}$  is Eulerian if it contains an Eulerian circuit.

Clearly, a bi-digraph of a digraph is an Eulerian graph. The main purpose of this paper is to characterize the biological behavior of biological  $n$ -systems with global stability by a combinatorial approach, i.e., establish the relationship between solvable subsystems of a biological  $n$ -system with that of labeling Eulerian subgraphs of labeling bi-digraph  $(\vec{G} \cup \overleftarrow{G})^{\hat{L}}$  of  $\vec{G}^L$ , characterize conditions of an  $n$ -system with linear growth rate become distinct and global stability, and interpret also the biological behavior of  $G^L$ -solutions of non-solvable equations, which opened a way for characterizing biological system with species more than 3, i.e., mathematical combinatorics, or differential equations over graphs.

For terminologies and notations not mentioned here, we follow references [1] for mechanics, [25] for interaction particles, [2] and [20] for biological mathematics, [3] for differential equations with stability, [6]-[7] for topological graphs, digraphs and combinatorial geometry, [7] and [26] for Smarandache multispaces.

## §2. Geometry Over Equilibrium Points

### 2.1 Equilibrium Sets

We consider the generalized Kolmogorov model on biological  $n$ -system ([2], [20]), i.e., the system (1.1) of differential equations

$$\left\{ \begin{array}{l} \dot{x}_1 = x_1 \left( \sum_{v_k \in N^-(v_1)} f'_{k1}(x_k, x_1) - \sum_{v_l \in N^+(v_1)} f_{1l}(x_1, x_l) \right) \\ \dot{x}_2 = x_2 \left( \sum_{v_k \in N^-(v_2)} f'_{k2}(x_k, x_2) - \sum_{v_l \in N^+(v_2)} f_{2l}(x_2, x_l) \right) \\ \dots\dots\dots \\ \dot{x}_n = x_n \left( \sum_{v_k \in N^-(v_n)} f'_{kn}(x_k, x_n) - \sum_{v_l \in N^+(v_n)} f_{nl}(x_n, x_l) \right) \end{array} \right.$$

satisfying conditions following:

- (1)  $f_{ij}, f'_{ij} \in \mathbb{C}^1$  for integers  $1 \leq i, j \leq n$ ;







and so that for equations  $x - y = -1$  and  $x - y = 1$ , i.e., there are no solutions  $x_0, y_0$  hold with this system. But  $(LES_4^S)$  is solvable with  $x = 1$  and  $y = 1$ . Can we conclude that things  $T'_1, T'_2, T'_3, T'_4$  are  $x = 1, y = 1$  and  $T_1, T_2, T_3, T_4$  are nothing? Certainly not because  $(x, y) = (1, 1)$  is the intersection of straight line behavior of things  $T'_1, T'_2, T'_3, T'_4$  and there are no intersection of  $T_1, T_2, T_3, T_4$  in plane  $\mathbb{R}^2$ . However, they are indeed exist in  $\mathbb{R}^2$  such as those shown in Fig.6.

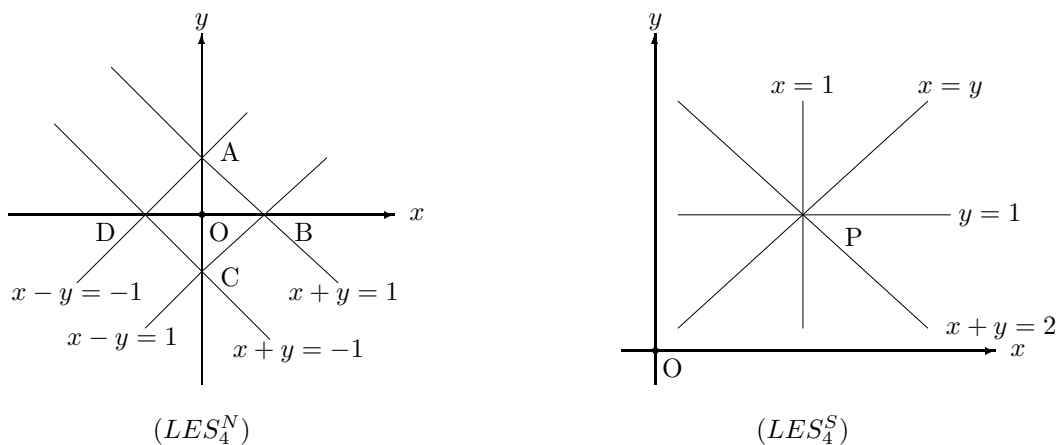

Fig.6

Denoted by the point set

$$L_{a,b,c} = \{(x, y) | ax + by = c, ab \neq 0\}$$

in  $\mathbb{R}^2$ . Then, we are easily know the straight line behaviors of  $T_1, T_2, T_3, T_4$  and  $T'_1, T'_2, T'_3, T'_4$  are nothings else but the unions  $L_{1,-1,0} \cup L_{1,1,2} \cup L_{1,0,1} \cup L_{0,1,1}$  and  $L_{1,1,1} \cup L_{1,1,-1} \cup L_{1,-1,-1} \cup L_{1,-1,1}$ , respectively.

**Definition 2.2** A  $\vee$ -solution, also called  $G$ -solution of system (2.4) is a labeling graph  $G^L$  defined by

$$V(G) = \{S_{F_i}, 1 \leq i \leq n\};$$

$$E(G) = \{(S_{F_i}, S_{F_j}) \text{ if } S_{F_i} \cap S_{F_j} \neq \emptyset \text{ for integers } 1 \leq i, j \leq n\} \text{ with a labeling}$$

$$L : S_{F_i} \rightarrow S_{F_i}, \quad (S_{F_i}, S_{F_j}) \rightarrow S_{F_i} \cap S_{F_j}.$$

**Example 2.3** The  $\vee$ -solutions of  $(LES_4^N)$  and  $(LES_4^S)$  are respectively labeling graphs  $C_4^L$  and  $K_4^L$  shown in Fig.7 following.

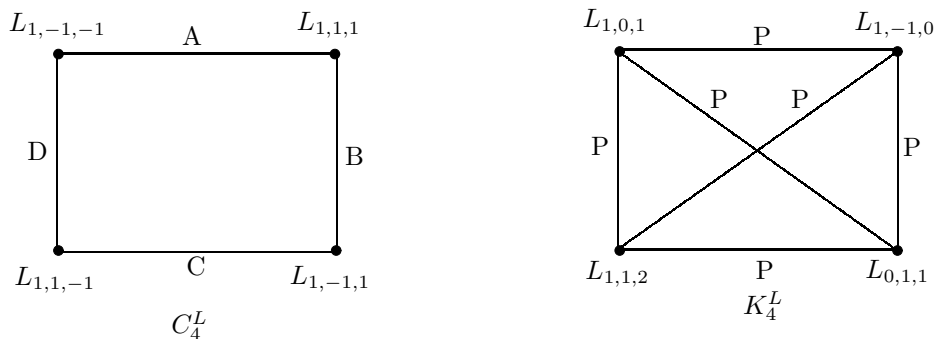

Fig.7

**Theorem 2.4** A system (2.4) of equations is  $\vee$ -solvable if  $F_i \in \mathbb{C}^1$  and  $F_i|_{(x_1^0, x_2^0, \dots, x_n^0)} = 0$  but  $\frac{\partial F_i}{\partial x_i}|_{(x_1^0, x_2^0, \dots, x_n^0)} \neq 0$  for any integer  $i, 1 \leq i \leq n$ .

*Proof* Applying the implicit function theorem, the proof is completed by definition.  $\square$

**Theorem 2.5** A system (1.1) of differential equations on food web  $\vec{G}^L$  is uniquely  $\vee$ -solvable if  $f_{ij}, f'_{ij} \in \mathbb{C}^1$  for integers  $1 \leq i, j \leq n$  and  $(x_1(0), x_2(0), \dots, x_n(0)) = (x_1^0, x_2^0, \dots, x_n^0) \in \mathbb{R}^n$ .

*Proof* Applying the existence and uniqueness theorem on the Cauchy problem of differential equations,

$$\dot{x}_i = x_i \left( \sum_{v_k \in N^-(v_i)} f'_{k1}(x_k, x_i) - \sum_{v_l \in N^+(v_i)} f_{1l}(x_i, x_l) \right)$$

with  $(x_1(0), x_2(0), \dots, x_n(0)) = (x_1^0, x_2^0, \dots, x_n^0) \in \mathbb{R}^n$ , it is uniquely solvable for any integer  $1 \leq i \leq n$ . Consequently, the system (1.1) is uniquely  $\vee$ -solvable in  $\mathbb{R}^n$  by definition.  $\square$

### 2.3 Equilibrium Sets of Linear Equations

Certainly, the Lotka-Volterra model on biological 2-system is a system of linear growth rates. Generally, if all  $f_{ij}, f'_{ij}$  are linear for integers  $1 \leq i, j \leq n$ , then it is a generalization of Lotka-Volterra model on biological  $n$ -system. We can further characterize the equilibrium sets of linear system (2.4) by linear algebra.

**Definition 2.6** For any positive integers  $i, j, i \neq j$ , the linear equations

$$\begin{aligned} a_{i1}x_1 + a_{i2}x_2 + \dots + a_{in}x_n &= b_i, \\ a_{j1}x_1 + a_{j2}x_2 + \dots + a_{jn}x_n &= b_j \end{aligned}$$

are called parallel if there exists a constant  $c$  such that

$$c = a_{j1}/a_{i1} = a_{j2}/a_{i2} = \dots = a_{jn}/a_{in} \neq b_j/b_i.$$

The following criterion is known in [8].

**Theorem 2.7**([8]) *For any integers  $i, j$ ,  $i \neq j$ , the linear equation system*

$$\begin{cases} a_{i1}x_1 + a_{i2}x_2 + \cdots + a_{in}x_n = b_i, \\ a_{j1}x_1 + a_{j2}x_2 + \cdots + a_{jn}x_n = b_j \end{cases}$$

*is non-solvable if and only if they are parallel.*

By Theorem 2.7, we divide all linear equations  $L_i$ ,  $1 \leq i \leq n$  in (2.4) into *parallel families*

$$\mathcal{C}_1, \mathcal{C}_2, \dots, \mathcal{C}_s$$

by the property that all equations in a family  $\mathcal{C}_i$  are parallel and there are no other equations parallel to equations in  $\mathcal{C}_i$  for integers  $1 \leq i \leq s$ . Denoted by  $|\mathcal{C}_i| = n_i$ ,  $1 \leq i \leq s$ . Then we can characterize equilibrium sets of linear system (2.1) by Theorem 2.6 in [8] following.

**Theorem 2.8**([8]) *The equilibrium sets of system (2.1) with linear growth rates  $f_{ij}, f'_{ij}$ ,  $1 \leq i, j \leq n$  can be classified into 3 classes following:*

(LC1) *there is only point  $(0, 0, \dots, 0) \in \mathbb{R}^n$  holding with linear system (2.1), i.e., its  $\vee$ -solution*

$$G^L \simeq K_{n_1, n_2, \dots, n_s}^L$$

*with  $n_1 + n_2 + \dots + n_s = n$ , where  $n_i = |\mathcal{C}_i|$  and  $\mathcal{C}_i$  is the parallel family for integers  $1 \leq i \leq s$ ,  $s \geq 2$ .*

(LC2) *there is only point  $(0, \dots, 0, c_1, 0, \dots, 0, c_2, 0, \dots, 0, c_{n-l}, 0, \dots, 0) \in \mathbb{R}^n$  holding system (2.1) with numbers  $c_1, c_2, \dots, c_{n-l} > 0$  respectively on columns  $i_1, i_2, \dots, i_{n-l}$  for  $1 \leq l < n$ , i.e., its  $\vee$ -solution*

$$G^L \simeq K_{n_1, n_2, \dots, n_t}^L$$

*with  $n_1 + n_2 + \dots + n_t = l$ , where  $n_i = |\mathcal{C}_i|$  and  $\mathcal{C}_i$  is the parallel family for integers  $1 \leq i \leq t$ ,  $s \geq 2$ .*

(LC3) *there is an unique point  $(c_1, c_2, \dots, c_n) \in \mathbb{R}^n$  holding linear system (2.1) with constant  $c_i > 0$  for integers  $1 \leq i \leq n$ .*

### §3. Biology over Equations

Classically, a solvable system (1.1) of differential equations characterizes dynamical behaviors of a food web in area. However, the solvable systems are individual but non-solvable systems are universal. Then *what about biology over those of non-solvable systems (1.1)? Are there no biological significance?* The answer is negative.

Firstly, let us think about a food web how to run. Certainly, a food chain only follows a direct, linear pathway of one animal at a time, and different thing  $T$  has his own food chain for living, even for the same kind of things. For example, the eagle can lives respectively on



the rabbit, on the snake or on the both via its food chains snake→eagle or rabbit→eagle with interactions in Fig.1, i.e., although the eagle preys on the snake and the rabbit but it is also dependent on the 2 populations such as those shown in Fig.8, and its living web should be consisted of circuits eagle→snake→eagle, eagle→rabbit→eagle or eagle→snake and rabbit→eagle, Eulerian subgraphs.

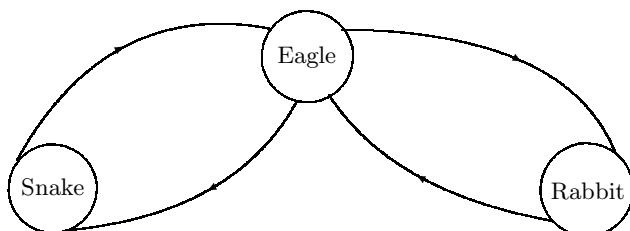

Fig.8

Generally, a predator  $P$  preys on a living thing  $T$ , i.e.,  $P$  action on  $T$  and there are also  $T$  reacts on  $P$  at the same time, which implies the interaction between living things, the in and out action exist together. We therefore know a biological fact following.

**Fact 3.1** *A living thing must live in an Eulerian subgraph of bi-digraph of a food web  $\vec{G}^L$ .*

The following result characterizes action flows on Eulerian subgraphs with that of solvable subsystems of equations (1.1).

**Theorem 3.2** *Let  $\vec{G}^L$  be a food web with solvable or non-solvable conservative equations (1.1) on initial value  $(x_1(0), x_2(0), \dots, x_n(0)) = (x_1^0, x_2^0, \dots, x_n^0)$  and  $\vec{H}^L \prec (\vec{G}^L \cup \overleftarrow{G})^{\hat{L}}$ , a food web containing species  $T$  with solvable conservation equations*

$$\dot{x}_{i_0} = x_{i_0} \left( \sum_{v_k \in N^-(v_{i_0})} f'_{ki_0}(x_k, x_{i_0}) - \sum_{v_l \in N^+(v_{i_0})} f_{i_0l}(x_{i_0}, x_l) \right), \quad 1 \leq i_0 \leq |H| \quad (3.2)$$

in  $\vec{H}^L$  where  $L(v_{i_0}) = \dot{x}_{i_0}$ . Then  $\vec{H}$  is an Eulerian digraph and  $H^L$  is an action flow.

*Proof* If  $\vec{H}^L$  is a food web, by Fact 3.1  $\vec{H}$  must be an Eulerian digraph.

Now let  $x_{i_0} = f(x_1, x_2, \dots, x_n), 1 \leq i \leq |H|$  be the solution of (2.5). Notice that in solution  $x_{i_0}$ ,  $x_i$  can be any chosen constant  $c$ , particularly,  $x_i = 0$  if  $i \notin \{i_0, 1 \leq i \leq |H|\}$  in (3.2), i.e.,

$$x_{i_0} = f(0, \dots, 0, x_{1_0}, 0, \dots, 0, x_{2_0}, 0, \dots, 0, x_n, 0 \dots, 0), 1 \leq i \leq |H|$$

is also the solution of (2.5) with  $f_{ik}(x_i, x_k) = 0, f'_{ki}(x_k, x_i) = 0$ , which implies that  $\vec{H}^L$  is an action flow with conservation laws at each vertex.  $\square$

Let  $\vec{H}_1, \vec{H}_2, \dots, \vec{H}_s$  be subgraphs of digraph  $\vec{G}$  with  $\vec{H}_i \neq \vec{H}_j, \vec{H}_i \cap \vec{H}_j = \emptyset$  or  $\neq \emptyset$  for integers  $1 \leq j \leq s$ . If  $\vec{G} = \bigcup_{i=1}^s \vec{H}_i$ , they are called a *subgraph multi-decomposition* of

$\vec{G}$ . Furthermore, if each  $\vec{H}_i$  is Eulerian, such a decomposition is called an *Eulerian multi-decomposition*, denoted by  $\vec{G} = \bigoplus_{i=1}^s \vec{H}_i$ . For example, an Eulerian multi-decomposition of the graph on the left is shown on the right in Fig.9.

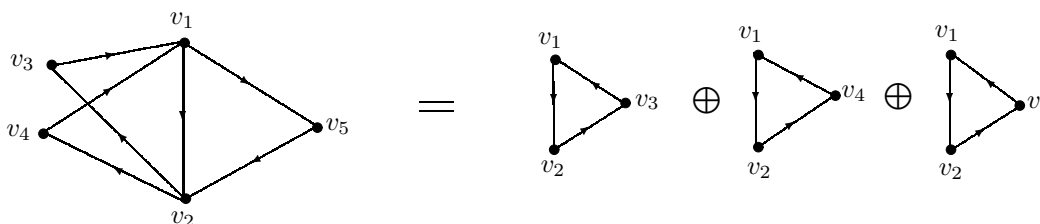

Fig.9

Particularly, if  $E(\vec{H}_i) \cap E(\vec{H}_j) = \emptyset$  for integers  $1 \leq i \neq j \leq s$ , such a decomposition on  $\vec{G}$  is called an *Eulerian decomposition* of  $\vec{G}$ .

The next result characterizes food webs by Eulerian multi-decomposition.

**Theorem 3.3** *If there are Eulerian subgraphs  $\vec{H}_i^L$ ,  $1 \leq i \leq s$  with solvable conservative equations, i.e., food webs such that  $\vec{G}^{\hat{L}} = \bigoplus_{i=1}^s \vec{H}_i^L$  with*

$$\hat{L} : v \rightarrow \sum_{i=1}^l \dot{x}_{v^i}, \quad \forall v \in V(\vec{G})$$

if  $v \in \bigcap_{i_0=1}^l V(\vec{H}_{i_0})$  with  $L(v) = \dot{x}_{v^i}$  in  $\vec{H}_{i_0}^L$  and

$$\hat{L} : (u, v) \rightarrow \left( \sum_{i=1}^s F'_{i_i}(u \rightarrow v), (x, y), \sum_{i=1}^s F_{i_i}(v \rightarrow u) \right), \quad \forall (u, v) \in E(\vec{G}^{\hat{L}})$$

if  $(u, v) \in \bigcap_{j_0=1}^s E(\vec{H}_{j_0})$ , then  $\vec{G}^{\hat{L}}$  is also a food web, i.e., an action flow.

*Proof* Clearly,  $\vec{G}^{\hat{L}}$  is a labeling graph holding with conservative law on each vertex  $v \in V(\vec{G}^{\hat{L}})$ , i.e., an action flow. □

#### §4. Global Stability and Extinction

In biology, the generation is the necessary condition for the continuation of species in a food web constraint on the interaction, i.e., the stability in dynamics with small perturbations on initial values. Usually, the dynamical behavior is characterized by differential equations, which maybe solvable or not and can not immediately apply to the stability of food web  $\vec{G}^L$  for  $n \geq 3$  by Theorems 3.2 and 3.3. Generalizing the classical stability enables one to define the stability of food web following.

**Definition 4.1** A food web  $\vec{G}^L$  with initial value  $\vec{G}^{L_0}$ , where  $L(v) = \dot{x}_v$ ,  $L_0(v) = \dot{x}_v^0$  for  $v \in V(\vec{G}^L)$  is globally stable or asymptotically stable for any initial value  $\vec{G}^{L'_0}$ , where  $L'_0(v) = \dot{y}_v^0$  for  $v \in V(\vec{G}^L)$  and a number  $\varepsilon_v > 0$ , there is always a number  $\delta_v > 0$  such that if  $|y_v^0 - x_v^0| < \delta_v$  exists for all  $t \geq 0$ , then

$$|y_v(t) - x_v(t)| < \varepsilon_v, \quad \forall v \in V(\vec{G}^L),$$

or furthermore,

$$\lim_{t \rightarrow 0} |y_v(t) - x_v(t)| = 0, \quad \forall v \in V(\vec{G}^L).$$

Certainly, we need new criterions on the classic for discussing the stability of species in biology.

**Theorem 4.2** A food web  $\vec{G}^L$  with initial value  $\vec{G}^{L_0}$  is globally stable or asymptotically stable if and only if there is an Eulerian multi-decomposition

$$\left(\vec{G} \cup \overleftarrow{G}\right)^{\hat{L}} = \bigoplus_{i=1}^s \vec{H}_i^L$$

with solvable stable or asymptotically stable conservative equations on labeling Eulerian subgraphs  $\vec{H}_i^L$  for integers  $1 \leq i \leq s$ .

*Proof* The necessary is obvious because if  $\vec{G}^L$  with initial value  $\vec{G}^{L_0}$  is globally stable or asymptotically stable, then  $\left(\vec{G} \cup \overleftarrow{G}\right)^{\hat{L}}$  is Eulerian itself by Fact 3.1.

Now if there is an Eulerian multi-decomposition

$$\left(\vec{G} \cup \overleftarrow{G}\right)^{\hat{L}} = \bigoplus_{i=1}^s \vec{H}_i^L$$

on labeling bi-digraph  $\left(\vec{G} \cup \overleftarrow{G}\right)^{\hat{L}}$  with stable or asymptotically stable conservative equations on labeling Eulerian subgraphs  $\vec{H}_i^L$ , i.e., for any number  $\varepsilon_v > 0$ , there is a number  $\delta_v > 0$  such that if  $|y_v^0 - x_v^0| < \delta_v$  exists for all  $t \geq 0$ , then

$$|y_v(t) - x_v(t)| < \varepsilon_v, \quad \forall v \in V(\vec{H}_i^L),$$

or furthermore,

$$\lim_{t \rightarrow 0} |y_v(t) - x_v(t)| = 0, \quad \forall v \in V(\vec{H}_i^L)$$

for integers  $1 \leq i \leq s$ , let  $\lambda_v$  be the multiple of vertex  $v \in V(\vec{G}^L)$  appeared in subgraphs  $\vec{H}_i^L, 1 \leq i \leq s$ , we then know that

$$|y_v(t) - x_v(t)| < \varepsilon_v^i$$

for  $v \in V(\vec{H}_i^L)$  if  $|y_v^0 - x_v^0| < \delta_v^i$  for integers  $1 \leq i \leq \lambda_v$ .

Define

$$\delta_v = \min\{\delta_v^i, 1 \leq i \leq \lambda_v\} \quad \text{and} \quad \varepsilon_v = \max\{\varepsilon_v^i, 1 \leq i \leq \lambda_v\}.$$

We therefore know that

$$|y_v(t) - x_v(t)| < \varepsilon_v,$$

i.e., the species on vertex  $v$  is stable if the conservative equations of  $\vec{H}_i^L$  are stable for integers  $1 \leq i \leq \lambda_v$  and  $\vec{G}^L$  is globally stable.

Now if furthermore,  $x_v$  is asymptotically stable, i.e.,

$$\lim_{t \rightarrow 0} |y_v(t) - x_v(t)| = 0$$

in food web  $\vec{H}_i^L, 1 \leq i \leq \lambda_v$ , it is clear that

$$\lim_{t \rightarrow 0} |y_v(t) - x_v(t)| = 0$$

in  $\vec{G}^L$  also, i.e.,  $\vec{G}^L$  is globally asymptotically stable. This completes the proof. □

**Corollary 4.3** *A food web  $\vec{G}^L$  with initial value  $\vec{G}^{L_0}$  is globally stable or asymptotically stable if there is an Eulerian decomposition*

$$\left(\vec{G} \cup \overleftarrow{G}\right)^{\hat{L}} = \bigoplus_{i=1}^s \vec{H}_i^L$$

with solvable stable or asymptotically stable conservative equations on labeling Eulerian sub-graphs  $\vec{H}_i^L$  for integers  $1 \leq i \leq s$ .

Clearly, the bi-digraph  $\vec{G} \cup \overleftarrow{G}$  has an Eulerian decomposition, called *parallel decomposition*

$$\vec{G} \cup \overleftarrow{G} = \bigoplus_{(u,v) \in E(\vec{G})} \left( (u,v) \cup (v,u) \right).$$

We get the next conclusion.

**Corollary 4.4** *A food web  $\vec{G}^L$  with initial value  $\vec{G}^{L_0}$  is globally stable or asymptotically stable if it is parallel stable or asymptotically stable, i.e.,  $((u,v) \cup (v,u))^{\hat{L}}$  is an action flow for  $\forall (u,v) \in E(\vec{G}^L)$ .*

For an equilibrium point  $\vec{G}^{L_0}$  of (2.1), we can also linearize  $F(v,u), F'(v,u)$  at  $(x_0, y_0)$  for  $\forall (v,u) \in E(\vec{G}^L)$  and know the stable behavior of  $\vec{G}^L$  in neighborhood of  $\vec{G}^{L_0}$  by applying the following well-known result.

**Theorem 4.5**([3]) *If an  $n$ -dimensional system  $\dot{X} = F(X)$  has an equilibrium point  $X_0$  that is hyperbolic, i.e., all of the eigenvalues of  $DF_{X_0}$  have nonzero real parts, then the nonlinear flow is conjugate to the flow of the linearized system in a neighborhood of  $X_0$ .*

The next result on the stability of food webs is an immediate application of Theorem 4.5.

**Theorem 4.6** *A food web  $\vec{G}^L$  with initial value  $\vec{G}^{L_0}$  is globally asymptotically stable if there is an Eulerian multi-decomposition*

$$\left(\vec{G} \cup \overleftarrow{G}\right)^{\hat{L}} = \bigoplus_{k=1}^s \vec{H}_k^L$$

with solvable conservative equations such that  $Re\lambda_i < 0$  for characteristic roots  $\lambda_i$  of  $A_v$  in the linearization  $A_v X_v = 0_{h_v \times h_v}$  of conservative equations at an equilibrium point  $\vec{H}_k^{L_0}$  in  $\vec{H}_k^L$  for integers  $1 \leq i \leq h_v$  and  $v \in V(\vec{H}_k^L)$ , where  $V(\vec{H}_k^L) = \{v_1, v_2, \dots, v_{h_v}\}$ ,

$$A_v = \begin{pmatrix} a_{11}^v & a_{12}^v & \cdots & a_{1h_v}^v \\ a_{21}^v & a_{22}^v & \cdots & a_{2h_v}^v \\ \vdots & \vdots & \ddots & \vdots \\ a_{h_1}^v & a_{h_2}^v & \cdots & a_{h_{h_v}}^v \end{pmatrix}$$

a constant matrix and  $X_k = (x_{v_1}, x_{v_2}, \dots, x_{v_{h_v}})^T$  for integers  $1 \leq k \leq l$ .

*Proof* Applying the theory of linear ordinary differential equations, we are easily know the species

$$x_v(t) = \sum_{i=1}^{h_v} c_i \bar{\beta}_i(t) e^{\lambda_i t},$$

where,  $c_i$  is a constant,  $\bar{\beta}_i(t)$  is an  $h_v$ -dimensional vector consisting of polynomials in  $t$  determined as follows

$$\begin{aligned} \bar{\beta}_1(t) &= \begin{bmatrix} t_{11} \\ t_{21} \\ \dots \\ t_{h_v 1} \end{bmatrix}, & \bar{\beta}_2(t) &= \begin{bmatrix} t_{11}t + t_{12} \\ t_{21}t + t_{22} \\ \dots \\ t_{n1}t + t_{h_v 2} \end{bmatrix}, \\ & \dots & & \dots \\ \bar{\beta}_{k_1}(t) &= \begin{bmatrix} \frac{t_{11}}{(k_1-1)!} t^{k_1-1} + \frac{t_{12}}{(k_1-2)!} t^{k_1-2} + \dots + t_{1k_1} \\ \frac{t_{21}}{(k_1-1)!} t^{k_1-1} + \frac{t_{22}}{(k_1-2)!} t^{k_1-2} + \dots + t_{2k_1} \\ \dots \\ \frac{t_{h_v 1}}{(k_1-1)!} t^{k_1-1} + \frac{t_{h_v 2}}{(k_1-2)!} t^{k_1-2} + \dots + t_{h_v k_1} \end{bmatrix}, \\ & \dots & & \dots \\ \bar{\beta}_{k_1+1}(t) &= \begin{bmatrix} t_{1(k_1+1)} \\ t_{2(k_1+1)} \\ \dots \\ t_{h_v(k_1+1)} \end{bmatrix}, & \bar{\beta}_{k_1+2}(t) &= \begin{bmatrix} t_{11}t + t_{12} \\ t_{21}t + t_{22} \\ \dots \\ t_{n1}t + t_{h_v 2} \end{bmatrix}, \end{aligned}$$



$$l = |\vec{G}| - s.$$

Notice that if species  $x$  is extinct, there must be  $\lim_{t \rightarrow +\infty} x(t) = 0$ . Let  $f(t)$  be a differentiable function on populations of a species  $x$ . If  $f(t) = O(t^{-\alpha})$ ,  $\alpha > 1$ , i.e., there are constants  $A > 0$  such that  $|f(t)| \leq At^{-\alpha}$  holds with  $t \in (0, +\infty)$ , then  $f$  is said to be  $\alpha$ -declined and  $x$  a species extinct in rate  $\alpha$ . Furthermore, if  $f(t) = O(e^{-\beta t})$  for  $\beta > 0$ , because

$$e^{\beta t} = 1 + \beta t + \frac{\beta^2}{2!}t^2 + \dots + \frac{\beta^n}{n!}t^n + \dots,$$

we are easily know that there is a constant  $A > 0$  such that  $|f(t)| \leq At^n$  for any integer  $n \geq 1$ . In this case,  $f$  is said to be  $\infty$ -declined and  $x$  a species extinct in rate  $\infty$ .

The results following characterize the extinct behavior of species in a food web.

**Theorem 4.8** *Let  $\vec{G}^L$  be a food web hold with labeling  $L : v_i \rightarrow \dot{x}_i$  on vertices  $v_i$ ,  $L : (v_i, v_j) \rightarrow \{F_{ij}, (x_i, x_j), F'_{ij}\}$  on edges for integers  $1 \leq i, j \leq n$ ,  $V \subset V(\vec{G}^L)$ . If*

$$V(t) = \sum_{v \in V} \left( \sum_{v' \in N^-(v)} F'_{v'v}(v' \rightarrow v) - \sum_{v' \in N^+(v)} F_{vv'}(v \rightarrow v') \right)$$

*is  $\alpha$ -decline, then all species  $X = \sum_{v \in V} x_v$  in  $V$  is extinct in at least rates  $\alpha - 1$  and particularly, if  $V = \{v\}$ , the species  $x_v$  is extinct in at least rates  $\alpha - 1$  on  $t$ .*

*Proof* Notice that the conservative equation at vertex  $v \in V$  is

$$\dot{x}_v = \sum_{v' \in N^-(v)} F'_{v'v}(x_{v'} \rightarrow x_v) - \sum_{v' \in N^+(v)} F_{vv'}(x_v \rightarrow x_{v'})$$

and

$$\begin{aligned} \dot{X} &= \frac{d\left(\sum_{v \in V} x_v\right)}{dt} = \sum_{v \in V} \dot{x}_v \\ &= \sum_{v \in V} \left( \sum_{v' \in N^-(v)} F'_{v'v}(v' \rightarrow v) - \sum_{v' \in N^+(v)} F_{vv'}(v \rightarrow v') \right). \end{aligned}$$

Now, if  $V(t)$  is  $\alpha$ -declined, there must be constant  $A > 0$  such that

$$-\frac{A}{t^\alpha} \leq \dot{X} = \sum_{v \in V} \left( \sum_{v' \in N^-(v)} F'_{v'v}(v' \rightarrow v) - \sum_{v' \in N^+(v)} F_{vv'}(v \rightarrow v') \right) = V(t) \leq \frac{A}{t^\alpha}.$$

Consequently,

$$|X| \leq \int_0^{+\infty} \frac{A}{t^\alpha} dt = A \int_0^{+\infty} \frac{1}{t^\alpha} dt = \frac{A}{(\alpha - 1)t^{\alpha-1}} = O(t^{-\alpha+1}).$$

Therefore, all species  $X$  in  $V$  is extinct in at least rates  $\alpha - 1$  on  $t$ , and particularly, it holds with the case of  $V = \{v\}$ .  $\square$

**Theorem 4.9** Let  $\vec{G}^L$  be a food web hold with labeling  $L : v_i \rightarrow \dot{x}_i$  on vertices  $v_i$ ,  $L : (v_i, v_j) \rightarrow \{F_{ij}, (x_i, x_j), F'_{ij}\}$  on edges for integers  $1 \leq i, j \leq n$ , and  $V \subset V(\vec{G}^L)$  a cut set with components  $C_1, C_2, \dots, C_l$  in  $\vec{G}^L \setminus V$ , where  $l \geq 2$ . If

$$\dot{f}_v(t) = \sum_{v' \in N^-(v)} F'_{v'v}(v' \rightarrow v) - \sum_{v' \in N^+(v)} F_{vv'}(v \rightarrow v')$$

is  $\alpha_v$ -declined for  $\forall v \in V$  with  $\alpha = \min_{v \in V} \alpha_v$ , then

- (1)  $\vec{G}^L$  turns to  $l$  food webs  $\vec{C}_1^L, \vec{C}_2^L, \dots, \vec{C}_l^L$  finally;
- (2) the species  $X_V = \sum_{v \in V} x_v$ , particularly,  $x_v$  is extinct in at least rates  $\alpha - 1$  on  $t$  for  $\forall v \in V$ .

*Proof* Applying Theorem 4.8, all species  $X$  in  $V$  is extinct in at least rates  $\alpha - 1$  on  $t$ , and finally, extinction if  $t \rightarrow \infty$ . In this case, there are only left components  $C_1, C_2, \dots, C_l$ , and each of them is a food web because if  $x_v = 0$ , there must be  $F(v \rightarrow u) = 0$  and  $F'(u \rightarrow v) = 0$  for  $\forall v \in V$  and  $u \in V(\vec{G}^L) \setminus V$ . Therefore, the conservative laws

$$\dot{x}_u = \sum_{v \in N^-(u)} F'_{vu}(x_u \rightarrow x_v) - \sum_{v \in N^+(u)} F_{uv}(x_u \rightarrow x_v)$$

in  $\vec{G}^L$  turns to

$$\dot{x}_u = \sum_{v \in N^-(u) \cap V(C_i)} F'_{vu}(x_v \rightarrow x_u) - \sum_{v \in N^+(u) \cap V(C_i)} F_{uv}(x_u \rightarrow x_v),$$

i.e., it holds also with vertex  $u$  in  $\vec{C}_i^L$  for integers  $1 \leq i \leq l$ , the assertion (1).

For (2), by the proof of Theorem 4.8 there is a number  $A > 0$  such that

$$-\int_0^{+\infty} \kappa(\vec{G}^L) \frac{A}{t^\alpha} dt \leq X_V(t) = \sum_{v \in V} x_v(t) \leq \int_0^{+\infty} \kappa(\vec{G}^L) \frac{A}{t^\alpha} dt$$

by definition, where  $\kappa(\vec{G}^L)$  is the connectivity of  $\vec{G}^L$ . Whence,  $X_V(t) = O(t^{-\alpha+1})$ , and particularly,  $x_v(t) = O(t^{-\alpha+1})$  for  $v \in V$ .  $\square$

Finally, there are indeed the case of extinction of species in rate  $\infty$ . For example, the proof of Theorem 4.6 implies the case of extinction in rate  $\infty$  on  $t$  following.

**Theorem 4.10** Let  $\vec{G}^L$  be food web with an Eulerian multi-decomposition

$$\left(\vec{G} \cup \overleftarrow{G}\right)^{\hat{L}} = \bigoplus_{k=1}^s \vec{H}_k^L$$



and all conservative equations on  $\vec{H}_k^L$  are solvable for integers  $1 \leq k \leq l$ . For a vertex  $v \in V(\vec{G}^L)$  including repeatedly in  $\vec{H}_{i_1}^L, \vec{H}_{i_2}^L, \dots, \vec{H}_{i_l}^L$ , if  $\text{Re}\lambda_i < 0$  for characteristic roots  $\lambda_i$  of  $A_k$  in the linearization

$$A_k X_k = 0_{h_k \times h_k}$$

of conservative equation at an equilibrium point  $\vec{H}_k^{L_0}$ ,  $v \in V(\vec{H}_k^L)$  for integers  $1 \leq i \leq h_k$ , then the species  $x_v$  is simultaneously extinct in rate  $\infty$  on time  $t$  and asymptotically stable, where  $V(\vec{H}_k^L) = \{v_1, v_2, \dots, v_{h_k}\}$ ,  $A_k$  and  $X_k$  are as the same in Theorem 4.6 for integers  $1 \leq k \leq l$ .

*Proof* By the proof of Theorem 4.6, we know that  $x_v(t)$  is asymptotically stable with

$$x_v(t) = \sum_{i=1}^{h_k} c_i \bar{\beta}_i(t) e^{\lambda_i t}.$$

Define  $\beta = \min_{1 \leq i \leq h_k} \lambda_i$ . If  $\lambda_i < 0$  for integers  $1 \leq i \leq h_k$ , then  $x_v(t)$  is clearly an  $\infty$ -declined function and species  $x_v$  is extinct in rate  $\infty$  on time  $t$ .  $\square$

## §5. Algorithm

Let  $\mathcal{G} = \{\mathcal{C}_1, \mathcal{C}_2, \dots, \mathcal{C}_m\}$  be solvable Eulerian multi-decompositions of bi-digraph  $(\vec{G} \cup \overleftarrow{G})^{\hat{L}}$  of a food web  $\vec{G}^L$  with conservation equations (1.1) solvable or not, where  $\mathcal{C}_1$  and  $\mathcal{C}_m$  are respectively a parallel decomposition,  $\vec{G}^L$  itself of  $\vec{G}^L$ . Theorems 4.2 and 4.6 conclude the following algorithm on the global stability of  $\vec{G}^L$ .

**Algorithm 5.1** *The stability of a food web  $\vec{G}^L$  can be determined by programming following:*

STEP 1. *Input  $X_i = \mathcal{C}_i$  and  $i = 1, 2, \dots, m$ ;*

STEP 2. *Determine Eulerian circuits in  $X_i$  is globally stable or not;*

STEP 3. *If  $X_i$  is globally stable, go to STEP 6; Otherwise, go to STEP 4;*

STEP 4. *Replace  $X_i$  by  $X_{i+1}$ , return to STEP 2;*

STEP 5. *If  $X_{i+1}$  is globally stable, go to STEP 6; Otherwise, go to STEP 4 if  $i < m$ , or go to STEP 7 if  $i = m$ ;*

STEP 6.  *$\vec{G}^L$  is globally stable, the algorithm is terminated;*

STEP 7.  *$\vec{G}^L$  is globally non-stable, the algorithm is terminated.*

This algorithm certainly enables one to determine the stability of a food web  $\vec{G}^L$  regardless of whether its conservation equations solvable or not, and get stability of food webs with more species than 3 by conclusions on 2 or 3 species.

**Example 5.2** Determine the stability of a biological 5-system  $\vec{G}^L$  shown in Fig.10,

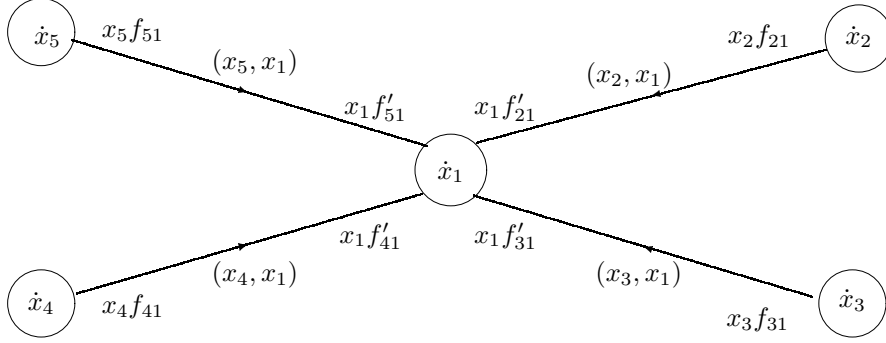

Fig.10

where,  $f_{ij}$  and  $f'_{ij}$ ,  $1 \leq i, j \leq 5$  are defined by

$$\begin{aligned} f_{21}(x_2, x_1) &= 1 - x_2 - \lambda_1 x_1, & f'_{21}(x_2, x_1) &= 1 - x_1 - \lambda_2 x_2, \\ f_{31}(x_3, x_1) &= 1 - x_3 - \lambda_1 x_1, & f'_{31}(x_3, x_1) &= 1 - x_1 - \lambda_3 x_3, \\ f_{41}(x_4, x_1) &= 1 - x_4 - \lambda_1 x_1, & f'_{41}(x_4, x_1) &= 1 - x_1 - \lambda_4 x_4, \\ f_{51}(x_5, x_1) &= 1 - x_5 - \lambda_1 x_1, & f'_{51}(x_5, x_1) &= 1 - x_1 - \lambda_5 x_5 \end{aligned}$$

with conservative equations

$$\begin{cases} \dot{x}_1 = x_1 (4 - 4x_1 - \lambda_2 x_2 - \lambda_3 x_3 - \lambda_4 x_4 - \lambda_5 x_5) \\ \dot{x}_2 = -x_2 (1 - x_2 - \lambda_1 x_1) \\ \dot{x}_3 = -x_3 (1 - x_3 - \lambda_1 x_1) \\ \dot{x}_4 = -x_4 (1 - x_4 - \lambda_1 x_1) \\ \dot{x}_5 = -x_5 (1 - x_5 - \lambda_1 x_1) \end{cases} \quad (5.1)$$

Let  $(x_1^0, x_2^0, x_3^0, x_4^0, x_5^0)$  be an equilibrium point of (5.1). Calculation shows the linearization of (5.1) is

$$\begin{cases} \dot{x}_1 = Ax_1 - \lambda_2 x_1^0 x_2 - \lambda_3 x_1^0 x_3 - \lambda_4 x_1^0 x_4 - \lambda_5 x_1^0 x_5 \\ \dot{x}_2 = \lambda_1 x_2^0 x_1 + (-1 + 2x_2^0 + \lambda_1 x_1^0) x_2 \\ \dot{x}_3 = \lambda_1 x_3^0 x_1 + (-1 + 2x_3^0 + \lambda_1 x_1^0) x_3 \\ \dot{x}_4 = \lambda_1 x_4^0 x_1 + (-1 + 2x_4^0 + \lambda_1 x_1^0) x_4 \\ \dot{x}_5 = \lambda_1 x_5^0 x_1 + (-1 + 2x_5^0 + \lambda_1 x_1^0) x_5 \end{cases}, \quad (5.2)$$

where  $A = 4 - 8x_1^0 - \lambda_2 x_2^0 - \lambda_3 x_3^0 - \lambda_4 x_4^0 - \lambda_5 x_5^0$ .

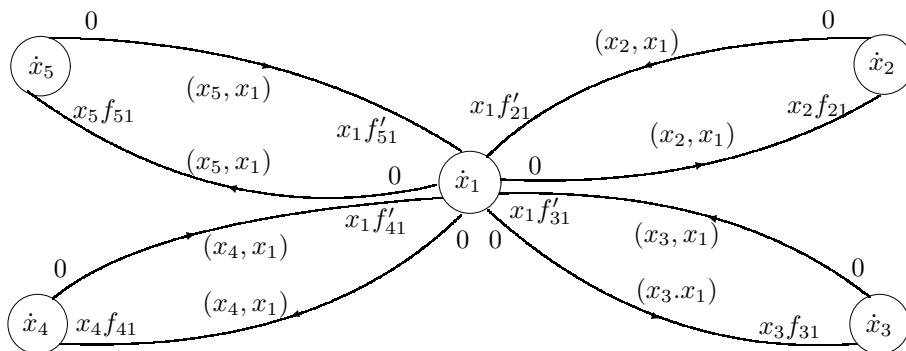

Fig.11

As usual, we can hold on the stability of system (5.2) of linear equations and then, the stability of (5.1) by Theorem 4.6 on equilibrium points with tedious calculation. However, we apply Algorithm 5.1 for the objective.

Notice that bi-digraph  $(\vec{G} \cup \overleftarrow{G})^{\hat{L}}$  of  $\vec{G}^L$  in Fig.11 has a parallel decomposition such as those shown in Fig.12,

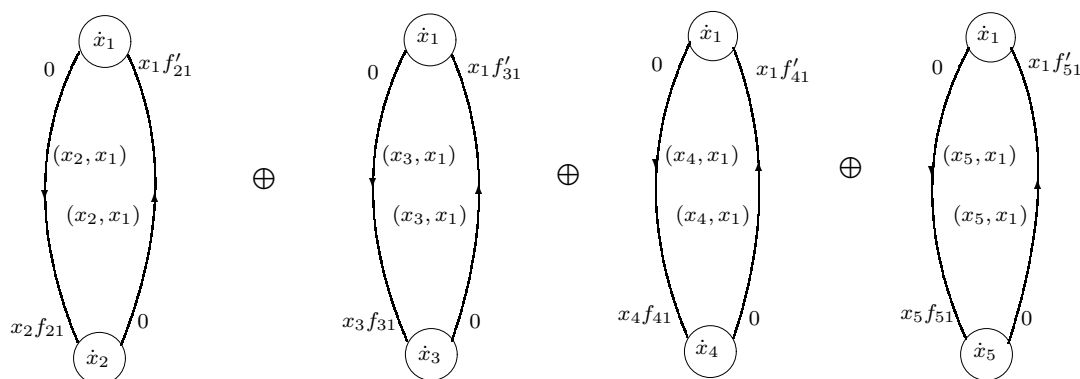

Fig.12

and the conservation equations on these parallel edges are respectively

$$\begin{cases} \dot{x}_1 = x_1(1 - x_1 - \lambda_2 x_2) \\ \dot{x}_2 = x_2(1 - x_2 - \lambda_1 x_1) \end{cases} \quad (5.3)$$

$$\begin{cases} \dot{x}_1 = x_1(1 - x_1 - \lambda_3 x_3) \\ \dot{x}_3 = x_3(1 - x_3 - \lambda_1 x_1) \end{cases} \quad (5.4)$$

$$\begin{cases} \dot{x}_1 = x_1(1 - x_1 - \lambda_4 x_4) \\ \dot{x}_4 = x_4(1 - x_4 - \lambda_1 x_1) \end{cases} \quad (5.5)$$

$$\begin{cases} \dot{x}_1 = x_1(1 - x_1 - \lambda_5 x_5) \\ \dot{x}_5 = x_5(1 - x_5 - \lambda_1 x_1) \end{cases} \quad (5.6)$$

We have known the stability of equations (5.3)-(5.6) by their linearizations following ([20]):

(1) the equilibrium point  $(x_1, x_i) = (0, 0)$  is unstable for equations (5.3)-(5.6), where  $i = 2, 3, 4, 5$ ;

(2) the equilibrium point  $(x_1, x_i) = (1, 0)$  is stable if  $\lambda_1 > 1$  for  $i = 2, 3, 4, 5$ ;

(3) the equilibrium point  $(x_1, x_i) = (0, 1)$  is stable if  $\lambda_i > 1$  for equations (5.3)-(5.6), where  $i = 2, 3, 4, 5$ ;

(4) the equilibrium point  $\left(\frac{\lambda_i - 1}{\lambda_1 \lambda_i - 1}, \frac{\lambda_1 - 1}{\lambda_1 \lambda_i - 1}\right)$  is asymptotically stable if  $\lambda_1 > 1$  and  $\lambda_i > 1$  for equations (5.3)-(5.6), where  $i = 2, 3, 4, 5$ .

Therefore, we know this biological 5-system is unstable on the equilibrium point  $(0, 0, 0, 0, 0)$  but stable on the equilibrium points  $(0, 1, 1, 1, 1)$  and  $(1, 0, 0, 0, 0)$ , and asymptotically stable on the equilibrium point

$$\left(\frac{\lambda - 1}{\lambda_1 \lambda - 1}, \frac{\lambda_1 - 1}{\lambda_1 \lambda - 1}, \frac{\lambda_1 - 1}{\lambda_1 \lambda - 1}, \frac{\lambda_1 - 1}{\lambda_1 \lambda - 1}, \frac{\lambda_1 - 1}{\lambda_1 \lambda - 1}\right)$$

of system (5.1) if  $\lambda > 1$  and  $\lambda_1 > 1$  by Theorem 4.2, where  $\lambda = \lambda_2 = \lambda_3 = \lambda_4 = \lambda_5$ .

## §6. Conclusion

Today, we have many mathematical theories but we are still helpless on opening the mystery of the nature as Einstein's complaint, i.e., *as far as the laws of mathematics refer to reality, they are not certain; and as far as they are certain, they do not refer to reality* because the multiple nature, or contradiction is universal on things, particularly, living things different from rigid bodies. Usually, we establish differential equations for characterizing things  $T$  and holds on their behavior by solutions, which is only hold on those of coherent behaviors of things, not the individual. Thus, we encounter non-solvable cases in biology, and even if it is solvable, finding the exact solution is nearly impossible in most cases. In fact, the solvable equation is individual but the non-solvable is universal for knowing the nature. This fact implies that we should also research those of non-solvable equations for revealing reality of things in mathematics, which finally brings about the mathematics over topological graphs, i.e., *action flows*, or *mathematical combinatorics*, and only which is the practicable way for understanding things, particularly, living things in the world.

## References

- [1] R.Abraham and J.E.Marsden, *Foundation of Mechanics* (2nd edition), Addison-Wesley, Reading, Mass, 1978.
- [2] Fred Brauer and Carlos Castillo-Chaver, *Mathematical Models in Population Biology and*

- Epidemiology*(2nd Edition), Springer, 2012.
- [3] Morris W.Hirsch, Stephen Smale and Robert L.Devaney, *Differential Equations, Dynamical Systems & An introduction to Chaos* (2nd Edition), Elsevier (Singapore) Pte Ltd, 2006.
  - [4] Y.Lou, Some reaction diffusion models in spatial ecology (in Chinese), *Sci.Sin. Math.*, Vol.45(2015), 1619-1634.
  - [5] Linfan Mao, Combinatorial speculation and combinatorial conjecture for mathematics, *International J.Math. Combin.* Vol.1(2007), No.1, 1-19.
  - [6] Linfan Mao, Geometrical theory on combinatorial manifolds, *JP J.Geometry and Topology*, Vol.7, No.1(2007),65-114.
  - [7] Linfan Mao, *Combinatorial Geometry with Applications to Field Theory*, The Education Publisher Inc., USA, 2011.
  - [8] Linfan Mao, Non-solvable spaces of linear equation systems, *International J.Math. Combin.*, Vol.2(2012), 9-23.
  - [9] Linfan Mao, Global stability of non-solvable ordinary differential equations with applications, *International J.Math. Combin.*, Vol.1 (2013), 1-37.
  - [10] Linfan Mao, Non-solvable equation systems with graphs embedded in  $\mathbf{R}^n$ , *Proceedings of the First International Conference on Smarandache Multispace and Multistructure*, The Education Publisher Inc. July, 2013
  - [11] Linfan Mao, Geometry on  $G^L$ -systems of homogenous polynomials, *International J.Contemp. Math. Sciences*, Vol.9 (2014), No.6, 287-308.
  - [12] Linfan Mao, Mathematics on non-mathematics - A combinatorial contribution, *International J.Math. Combin.*, Vol.3(2014), 1-34.
  - [13] Linfan Mao, Cauchy problem on non-solvable system of first order partial differential equations with applications, *Methods and Applications of Analysis*, Vol.22, 2(2015), 171-200.
  - [14] Linfan Mao, Extended Banach  $\vec{G}$ -flow spaces on differential equations with applications, *Electronic J.Mathematical Analysis and Applications*, Vol.3, No.2 (2015), 59-91.
  - [15] Linfan Mao, A new understanding of particles by  $\vec{G}$ -flow interpretation of differential equation, *Progress in Physics*, Vol.11(2015), 193-201.
  - [16] Linfan Mao, A review on natural reality with physical equation, *Progress in Physics*, Vol.11(2015), 276-282.
  - [17] Linfan Mao, Mathematics after CC conjecture – combinatorial notions and achievements, *International J.Math. Combin.*, Vol.2(2015), 1-31.
  - [18] Linfan Mao, Mathematics with natural reality–action flows, *Bull.Cal.Math.Soc.*, Vol.107, 6(2015), 443-474.
  - [19] Linfan Mao,Labeled graph – A mathematical element, *International J.Math. Combin.*, Vol.3(2016), 27-56.
  - [20] J.D.Murray, *Mathematical Biology I: An Introduction* (3rd Edition), Springer-Verlag Berlin Heidelberg, 2002.
  - [21] C.Neuhauser, Mathematical challenges in spatial ecology, *Notices in AMS*, Vol.48, 11(2001), 1304-1414.
  - [22] Paine R. T., Food webs: linkage, interaction strength and community infrastructure, *Journal of Animal Ecology*, Vol.49, 3(1980), 666-685.

- [23] Pimm S. L., The structure of food webs, *Theoretical Population Biology*, 16 (1979), 144-158.
- [24] Proulx S. R., Promislow D. E. L. and Phillips, P. C., Network thinking in ecology and evolution, *Trends in Ecology and Evolution*, Vol.20,6(2005), 345-353.
- [25] Quang Ho-Kim and Pham Xuan Yem, *Elementary Particles and Their Interactions*, Springer-Verlag Berlin Heidelberg, 1998.
- [26] F.Smarandache, *Paradoxist Geometry*, State Archives from Valcea, Rm. Valcea, Romania, 1969, and in *Paradoxist Mathematics*, Collected Papers (Vol. II), Kishinev University Press, Kishinev, 5-28, 1997.
- [27] Y.M.Svirezhev, Modern problems of mathematical ecology, *Proceedings of the International Congress of Mathematicians*, August 16-24, 1983, Warszawa.
- [28] Williams R. J. and Martinez N. D., Simple rules yield complex food webs, *Nature*, 404 (6774) (2000), 180-183.

## A Topological Model for Ecologically Industrial Systems

**Abstract:** An ecologically industrial system is such an industrial system in harmony with its environment, especially the natural environment. The main purpose of this paper is to show how to establish a mathematical model for such systems by combinatorics, and find its topological characteristics, which are useful in industrial ecology and the environment protection.

**Key Words:** Industrial system, ecology, Smarandache multisystem, combinatorial model, input-output analysis, circulating economy.

**AMS(2010):** 91B60

### §1. Introduction

Usually, the entirely life cycle of a product consists of mining, smelting, production, storage, transporting, use and then finally go to the waste,  $\dots$ , etc.. In this process, a lot of waste gas, water or solid waste are produced. Such as those shown in Fig.1 for a producing cell following.

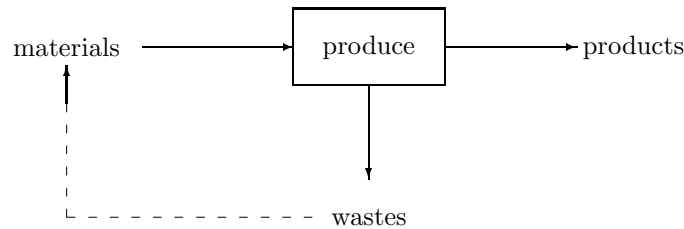

**Fig.1**

In old times, these wastes produced in industry are directly discarded to the nature without disposal, which brings about an serious problem to human beings, i.e., environment pollution and harmful to our survival. For minimizing the effects of these waste to our survival, the growth of industry should be in coordinated with the nature and the *3R rule*: reduces its amounts, reuses it and furthermore, into recycling, i.e., use these waste into produce again after disposal, or let them be the materials of other products and then reduce the total amounts of waste to our life environment. An *ecologically industrial system* is such a system consisting of industrial cells in accordance with the *3R rule* by setting up one or more waste disposal centers. Such a system is opened. Certainly, it can be transferred to a closed one by letting the environment as an additional cell. For example, series produces such as those shown in Fig.2 following.

---

<sup>1</sup>*International J.Math. Combin.*, Vol.1(2014), 109-117.

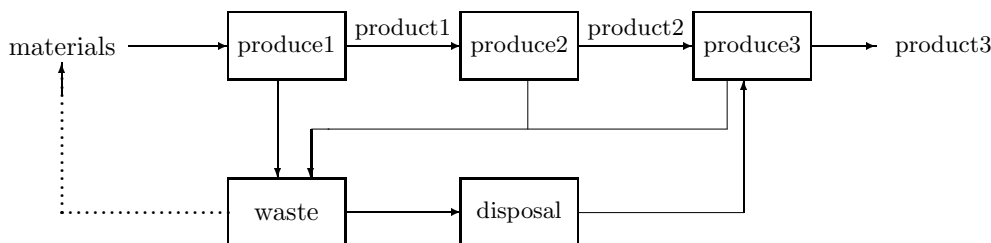

Fig.2

Generally, we can assume that there are  $P_1, P_2, \dots, P_m$  products (including by-products) and  $W_1, W_2, \dots, W_s$  wastes after a produce process. Some of them will be used, and some will be the materials of another produce process. In view of cyclic economy, such an ecologically industrial system is nothing else but a Smarandachely multisystem. Furthermore, it is a combinatorial system defined following.

**Definition 1.1**([1],[2] and [9]) *A rule in a mathematical system  $(\Sigma; \mathcal{R})$  is said to be Smarandachely denied if it behaves in at least two different ways within the same set  $\Sigma$ , i.e., validated and invalidated, or only invalidated but in multiple distinct ways.*

*A Smarandachely system  $(\Sigma; \mathcal{R})$  is a mathematical system which has at least one Smarandachely denied rule in  $\mathcal{R}$ .*

**Definition 1.2**([1],[2] and [9]) *For an integer  $m \geq 2$ , let  $(\Sigma_1; \mathcal{R}_1), (\Sigma_2; \mathcal{R}_2), \dots, (\Sigma_m; \mathcal{R}_m)$  be  $m$  mathematical systems different two by two. A Smarandache multispace is a pair  $(\tilde{\Sigma}; \tilde{\mathcal{R}})$  with*

$$\tilde{\Sigma} = \bigcup_{i=1}^m \Sigma_i, \quad \text{and} \quad \tilde{\mathcal{R}} = \bigcup_{i=1}^m \mathcal{R}_i.$$

**Definition 1.3**([1],[2] and [9]) *A combinatorial system  $\mathcal{C}_G$  is a union of mathematical systems  $(\Sigma_1; \mathcal{R}_1), (\Sigma_2; \mathcal{R}_2), \dots, (\Sigma_m; \mathcal{R}_m)$  for an integer  $m$ , i.e.,*

$$\mathcal{C}_G = \left( \bigcup_{i=1}^m \Sigma_i; \bigcup_{i=1}^m \mathcal{R}_i \right)$$

*with an underlying connected graph structure  $G$ , where*

$$V(G) = \{\Sigma_1, \Sigma_2, \dots, \Sigma_m\},$$

$$E(G) = \{ (\Sigma_i, \Sigma_j) \mid \Sigma_i \cap \Sigma_j \neq \emptyset, 1 \leq i, j \leq m \}.$$

The main purpose of this paper is to show how to establish a mathematical model for such systems by combinatorics, and find its topological characteristics with label equations. In fact, such a system of equations is non-solvable. As we discussed in references [3]-[8], such a non-solvable system of equations has significance also for things in our world and its global behavior can be handed by its  $G$ -solutions, where  $G$  is a topological graph inherited by this non-solvable system.



## §2. A Generalization of Input-Output Analysis

The 3R rule on an ecologically industrial system implies that such a system is optimal both in its economical and environmental results.

### 2.1 An Input-Output Model

The input-output model is a linear model in macro-economic analysis, established by a economist Leontief as follows, who won the Nobel economic prize in 1973.

Assume these are  $n$  departments  $D_1, D_2, \dots, D_n$  in a macro-economic system  $\mathcal{L}$  satisfy conditions following:

- (1) The total output value of department  $D_i$  is  $x_i$ . Among them, there are  $x_{ij}$  output values for the department  $D_j$  and  $d_i$  for the social demand, such as those shown in Fig.1.
- (2) A unit output value of department  $D_j$  consumes  $t_{ij}$  input values coming from department  $D_i$ . Such numbers  $t_{ij}$ ,  $1 \leq i, j \leq n$  are called *consuming coefficients*.

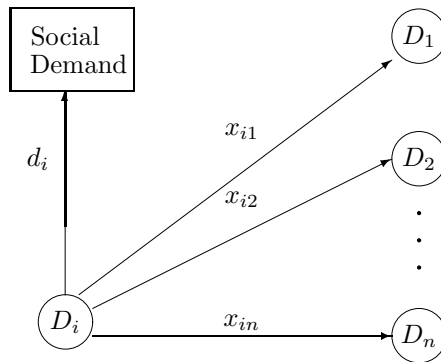

Fig.3

Therefore, such an overall balance macro-economic system  $\mathcal{L}$  satisfies  $n$  linear equations

$$x_i = \sum_{j=1}^n x_{ij} + d_i \tag{1}$$

for integers  $1 \leq i \leq n$ . Furthermore, substitute  $t_{ij} = x_{ij}/x_j$  into equation (10-1), we get that

$$x_i = \sum_{j=1}^n t_{ij}x_j + d_i \tag{2}$$

for any integer  $i$ . Let  $\mathbf{T} = [t_{ij}]_{n \times n}$ ,  $\mathbf{A} = \mathbf{I}_{n \times n} - \mathbf{T}$ . Then

$$\mathbf{A}\bar{x} = \bar{d}, \tag{3}$$

from (2), where  $\bar{x} = (x_1, x_2, \dots, x_n)^T$ ,  $\bar{d} = (d_1, d_2, \dots, d_n)^T$  are the output vector or demand

vectors, respectively.

For example, let  $\mathcal{L}$  consists of 3 departments  $D_1, D_2, D_3$ , where  $D_1$ =agriculture,  $D_2$ =manufacture industry,  $D_3$ =service with an input-output data in Table 1.

Department	$D_1$	$D_2$	$D_3$	Social demand	Total value
$D_1$	15	20	30	35	100
$D_2$	30	10	45	115	200
$D_3$	20	60	/	70	150

**Table 1**

This table can be turned to a consuming coefficient table by  $t_{ij} = x_{ij}/x_j$  following.

Department	$D_1$	$D_2$	$D_3$
$D_1$	0.15	0.10	0.20
$D_2$	0.30	0.05	0.30
$D_3$	0.20	0.30	0.00

**Table 2**

Thus

$$\mathbf{T} = \begin{bmatrix} 0.15 & 0.10 & 0.20 \\ 0.30 & 0.05 & 0.30 \\ 0.20 & 0.30 & 0.00 \end{bmatrix}, \quad \mathbf{A} = I_{3 \times 3} - \mathbf{T} = \begin{bmatrix} 0.85 & -0.10 & -0.20 \\ -0.30 & 0.95 & -0.30 \\ -0.20 & -0.30 & 1.00 \end{bmatrix}$$

and the input-output equation system is

$$\begin{cases} 0.85x_1 - 0.10x_2 - 0.20x_3 = d_1 \\ -0.30x_1 + 0.95x_2 - 0.30x_3 = d_2 \\ -0.20x_1 - 0.30x_2 + x_3 = d_3 \end{cases}$$

Solving this linear system of equations enables one to find the input and output data for economy management.

## 2.2 A Generalized Input-Output Model

Notice that our WORLD is not linear in general, i.e., the assumption  $t_{ij} = x_{ij}/x_j$  does not hold in general. A non-linear input-output model is shown in Fig.3, where  $\bar{x} = (x_{1i}, x_{2i}, \dots, x_{ni})$ ,  $D_1, D_2, \dots, D_n$  are  $n$  departments, SD=social demand. Usually, the function  $F(\bar{x})$  is called the *producing function*.

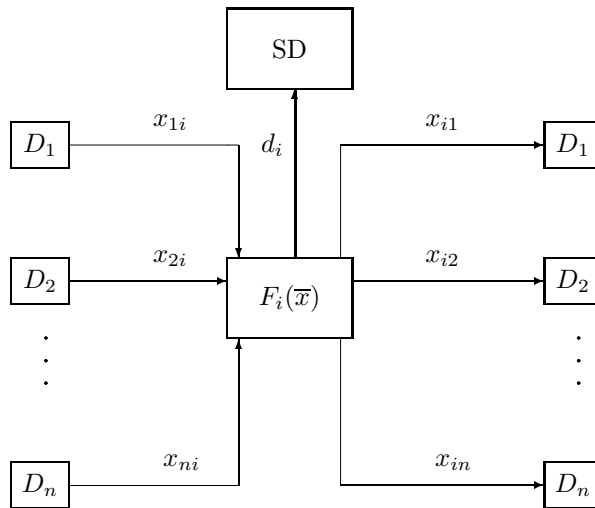

Fig.3

In this case, an overall balance input-output model is characterized by equations

$$F_i(\bar{x}) = \sum_{j=1}^n x_{ij} + d_i \tag{4}$$

for integers  $1 \leq i \leq n$ , where  $F_i(\bar{x})$  may be linear or non-linear and determined by a system of equations such as those of ordinary differential equations

$$1 \leq i \leq n \begin{cases} F_i^{(n)} + a_1 F_i^{(n-1)} + \dots + a_{n-1} F_i + a_n = 0 \\ F_i|_{t=0} = \varphi_0, F_i^{(1)}|_{t=0} = \varphi_1, \dots, F_i^{(n-1)}|_{t=0} = \varphi_{n-1} \end{cases} \tag{OES^n}$$

or

$$1 \leq i \leq n \begin{cases} \frac{\partial F_i}{\partial t} = H_1(t, x_1, \dots, x_{n-1}, p_1, \dots, p_{n-1}) \\ F_i|_{t=t_0} = \varphi_0(x_1, x_2, \dots, x_{n-1}) \end{cases}, \tag{PES^1}$$

which can be solved by classical mathematics. However, the input-output model with its generalized only consider the consuming and producing, neglected the waste and its affection to our environment. So it can be not immediately applied to ecologically industrial systems. However, we can generalize such a system for this objective by introducing environment factors, which are discussed in the next section.

### \$3. A Topological Model for Ecologically Industrial Systems

The essence of input-output model is in the output is equal to the input, i.e., a simple case of the *law of conservation of mass*: *a matter can be changed from one form into another, mixtures can be separated or made, and pure substances can be decomposed, but the total amount of*

mass remains constant. Applying this law, it needs the environment as an additional cell for ecologically industrial systems and replaces the departments  $D_i$ ,  $1 \leq i \leq n$  by input materials  $M_i$ ,  $1 \leq i \leq n$  or products  $P_k$ ,  $1 \leq k \leq m$ , and SD by  $W_i$ ,  $1 \leq i \leq s =$  wastes, such as those shown in Fig.4 following.

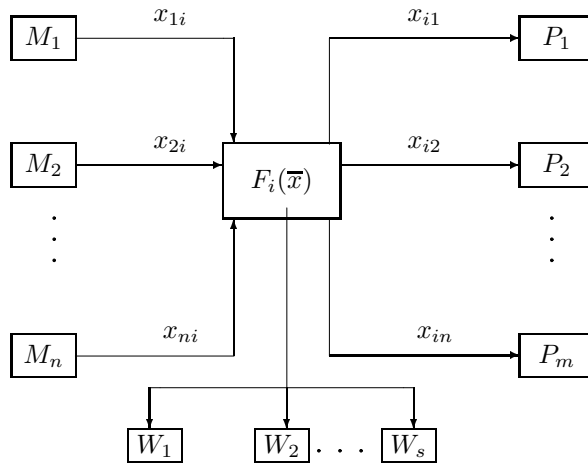

Fig.4

In this case, the balance input-output model is characterized by equations

$$F_i(\bar{x}) = \sum_{j=1}^n x_{ij} - \sum_{i=1}^s W_i \tag{5}$$

for integers  $1 \leq i \leq n$ . We construct a topological graphs following.

**Construction 3.1** Let  $\mathcal{J}(t)$  be an ecologically industrial system consisting of cells  $C_1(t), C_2(t), \dots, C_l(t)$ ,  $R$  the environment of  $\mathcal{J}$ . Define a topological graph  $G[\mathcal{J}]$  of  $\mathcal{J}$  following:

$$\begin{aligned} V(G[\mathcal{J}]) &= \{C_1(t), C_2(t), \dots, C_l(t), R\}; \\ E(G[\mathcal{J}]) &= \{(C_i(t), C_j(t)) \text{ if there is an input from } C_i(t) \text{ to } C_j(t), 1 \leq i, j \leq l\} \\ &\quad \cup \{(C_i(t), R) \text{ if there are wastes from } C_i(t) \text{ to } R, 1 \leq i \leq l\}. \end{aligned}$$

Clearly,  $G[\mathcal{J}]$  is an inherited graph for an ecologically industrial system  $\mathcal{J}$ . By the 3R rule, any producing process  $X_{i_1}$  of an ecologically industrial system is on a directed cycle  $\vec{C} = (X_{i_1}, X_{i_2}, \dots, X_{i_k})$ , where  $X_{i_j} \in \{C_i, 1 \leq j \leq l; R\}$ , such as those shown in Fig.5.

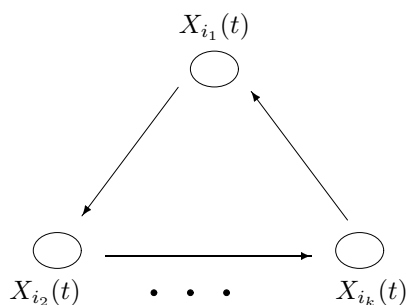

Fig.5

Such structure of cycles naturally determined the topological structure of an ecologically industrial system following.

**Theorem 3.2** *Let  $\mathcal{J}(t)$  be an ecologically industrial system consisting of producing cells  $C_1(t), C_2(t), \dots, C_l(t)$  underlying a graph  $G[\mathcal{J}(t)]$ . Then there is a cycle-decomposition*

$$G[\mathcal{J}(t)] = \bigcup_{i=1}^t \vec{C}_{k_i}$$

for the directed graph  $G[\mathcal{J}(t)]$  such that each producing process  $C_i(t)$ ,  $1 \leq i \leq l$  is on a directed circuit  $\vec{C}_{k_i}$  for an integer  $1 \leq i \leq t$ . Particularly,  $G[\mathcal{J}(t)]$  is 2-edge connectness.

*Proof* By definition, each producing process  $C_i(t)$  is on a directed cycle, which enables us to get a cycle-decomposition

$$GG[\mathcal{J}(t)] = \bigcup_{i=1}^t \vec{C}_{k_i}. \quad \square$$

Thus, any ecologically industrial system underlying a topological 2-edge connect graph with vertices consisting of these producing process. Whence, we can always call  $G$ -system for an ecologically industrial system. Clearly, the global effects of  $G_1$ -system and  $G_2$ -system are different if  $G_1 \neq G_2$  by definition. Certainly, we can also characterize these  $G$ -systems with graphs by equations (5) following.

**Theorem 3.3** *Let a  $G$ -system consist of producing cells  $C_1(t), C_2(t), \dots, C_l(t)$  underlying a graph  $G[\mathcal{J}(t)]$ . Then*

$$F_v(x_{uv}, u \in N_{G[\mathcal{J}(t)]}^-(v)) = \sum_{w \in N_{G[\mathcal{J}(t)]}^+(v)} (-1)^{\delta(v,w)} x_{vw}$$

with  $\delta(v, w) = 1$  if  $x_{vw}$ =product, and  $-1$  if  $x_{vw}$ =waste, where  $N_{G[\mathcal{J}(t)]}^-, N_{G[\mathcal{J}(t)]}^+$  are the in or our-neighborhoods of vertex  $v$  in  $G[\mathcal{J}(t)]$ .

Notice that the system of equations in Theorem 3.3 is non-solvable in  $\mathbb{R}^{\Delta+1}$  with  $\Delta$  the maximum valency of vertices in  $G[\mathcal{J}(t)]$ . However, we can also find its  $G[\mathcal{J}(t)]$ -solution in

$\mathbb{R}^{\Delta+1}$  (See [4]-[6] for details), which can be also applied for holding the global behavior of such  $G$ -systems. Such a  $G[\mathcal{J}(t)]$ -solution is not constant for  $\forall e \in E(G[\mathcal{J}(t)])$ . For example, let a  $G$ -system with  $G$ =circuit be shown in Fig.4.

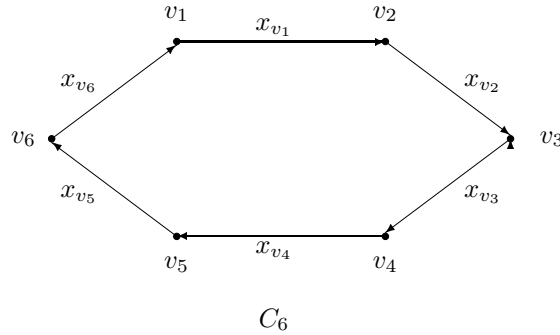

**Fig.5**

Then there are no wastes to environment with equations

$$F_v(x_{v_i}) = x_{v_{i+1}}, \quad 1 \leq i \leq 6, \quad \text{where } i \bmod 6, \text{ i.e.,}$$

$$F_{v_i} F_{v_{i+1}} \cdots F_{v_{i+6}} = 1 \text{ for any integer } 1 \leq i \leq 6.$$

If  $F_{v_i}$  is given, then solutions  $x_{v_i}$ ,  $1 \leq i \leq 6$  dependent on an initial value, for example,  $x_{v_1}|_{t=0}$ , i.e., one needs the choice criterions for determining the initial values  $x_{v_i}|_{t=0}$ . Notice that an industrial system should harmonizes with its environment. The only criterion for its choice must be

*Optimal in economy with minimum affection to the environment, or approximately, maximum output with minimum input.*

According to this criterion, there are 2 types of  $G$ -systems approximating to an ecologically industrial system:

- (1) Optimal in economy with all inputs (wastes)  $W_{r_1}, W_{r_2}, \dots, W_{r_s}$  licenced to  $R$ ;
- (2) Minimal wastes to the environment, i.e., minimal used materials but supporting the survival of human beings.

For a  $G$ -system, let

$$c_v^- = \sum_{u \in N_{G[\mathcal{J}(t)]}^-(v)} c(x_{uv}) \text{ and } c_v^+ = \sum_{w \in N_{G[\mathcal{J}(t)]}^+(v)} (-1)^{\delta(v,w)} c(x_{vw})$$

be respectively the producing costs and product income at vertex  $v \in V(G)$ . Then the optimal function is

$$\begin{aligned}\Lambda(G) &= \sum_{v \in V(G)} (c_v^+ - c_v^-) \\ &= \sum_{v \in V(G)} \left( \sum_{w \in N_{G[\mathcal{J}(t)]}^+(v)} (-1)^{\delta(v,w)} c(x_{vw}) - \sum_{u \in N_{G[\mathcal{J}(t)]}^-(v)} c(x_{uv}) \right).\end{aligned}$$

Then, a  $G$ -system of Types 1 is a mathematical programming

$$\max \sum_{v \in V(G)} \Lambda(G) \quad \text{but} \quad \sum_{v \in V(G)} W_{ri} \leq W_{ri}^U,$$

where  $W_{ri}^U$  is the permitted value for waste  $W_{ri}$  to the nature for integers  $1 \leq i \leq s$ . Similarly, a  $G$ -system of Types 2 is a mathematical programming

$$\min \sum_{v \in V(G)} W_{ri} \quad \text{but all products } P \geq P^L,$$

where  $P^L$  is the minimum needs of product  $P$  in an area or a country. Particularly, if  $W_{ri}^U = 0$ , i.e., an ecologically industrial system, such a system can be also characterized by a non-solvable system of equations

$$F_v(x_{uv}, u \in N_{G[\mathcal{J}(t)]}^-(v)) = \sum_{w \in N_{G[\mathcal{J}(t)]}^+(v)} x_{vw} \quad \text{for } \forall v \in V(G).$$

## References

- [1] Linfan Mao, *Smarandache Multi-Space Theory*, The Education Publisher Inc. 2011.
- [2] Linfan Mao, *Combinatorial Geometry with Applications to Field Theory* (Second edition), The Education Publisher Inc., USA, 2011.
- [3] Linfan Mao, Non-solvable spaces of linear equation systems. *International J. Math. Combin.*, Vol.2 (2012), 9-23.
- [4] Linfan Mao, Global stability of non-solvable ordinary differential equations with applications, *International J.Math. Combin.*, Vol.1 (2013), 1-37.
- [5] Linfan Mao, Non-solvable equation systems with graphs embedded in  $\mathbf{R}^n$ , *International J.Math. Combin.*, Vol.2 (2013), 8-23.
- [6] Linfan Mao, Geometry on  $G^L$ -systems of homogenous polynomials, Submitted.
- [7] Linfan Mao, Non-solvable partial differential equations of first order with applications, Submitted.
- [8] Linfan Mao, Mathematics on non-mathematics, Submitted.
- [9] F.Smarandache, *A Unifying Field in Logics. Neutrosophy: Neutrosophic Probability, Set, and Logic*, American research Press, Rehoboth, 1999.
- [10] Zengjun Yuan and Jun Bi, *Industrial Ecology*, Science Press, Beijing, 2010.

# Index

## A

action flow 10, 24, 64, 377  
action principle of fields 296  
algebraically contradictory 36, 201, 242, 293  
algebraic  $G$ -system 117  
algebra on graph 27  
asymptotically  $\omega$ -stable 43  
asymptotically prod-stable 176, 178, 215  
asymptotically sum-stable 174, 178, 215  
 $A_0$ -flow space 345

## B

Banach  $\vec{G}$ -flow space 28, 66, 383  
Banach flow space 347  
bigroup 276  
bi-digraph 71, 464  
bifield 276  
bimodule 276  
biring 276  
bounded operator 315, 342  
2-branching universe 57

## C

CC Conjecture 111, 274, 399  
CCM Conjecture 255  
CCS Conjecture 255  
circulating economic system 136  
closed graph theorem 39  
combinatorial algebra 275  
combinatorial connection space 409, 422, 445  
combinatorial cosmos 266  
combinatorial curvature operator 409  
combinatorial Euclidean space 279, 400, 441  
combinatorial fan-space 400  
combinatorial field 397  
combinatorial field strength 417  
combinatorial gauge basis 417  
combinatorial gauge potential 417

combinatorial manifold 39, 401, 421, 442  
combinatorial metric 448  
    homotopically equivalent 42  
combinatorially Riemannian curvature tensor 430, 446  
combinatorially Riemannian manifold 422  
combinatorially Riemannian geometry 422  
combinatorial map 256  
combinatorial metric 448  
combinatorial spacetime 440  
combinatorial Schwarzschild metric 449  
combinatorial Reissner-Nordström metric 452  
combinatorialization of algebra 258  
combinatorialization of geometries 260  
complete synchronization 14  
connection on combinatorial manifold 421  
connection on tensors 408, 444  
connection on principal fiber bundle 415  
conservation laws 65, 79  
conservation equation 304  
conservative family 305  
continuity flow 9, 340  
    complex flow 10  
    combinatorially homeomorphic 41  
    combinatorially isometric 42  
     $\vec{G}$ -flow 10  
    differential operators 67  
    inner product 81  
    integral operators 67  
    norm product 81  
continuous operator 82, 317, 341  
contradiction 231  
contractor 316, 342  
curvature form 416  
curvature tensor 445

## D

d-dimensional connected 403  
d-dimensional graph 404  
differentiable combinatorial manifold 405, 442  
differentiable non-manifold 132  
differentiable principal fiber bundle 413



differentially contradictory 201, 242, 293  
 differential flow 25  
 differential operator on  $\vec{G}$ -flow 319  
 Dirac equation 76

**E**

ecologically industrial system 248, 337, 486  
 energy-index 222  
 Einstein's gravitational equations 139, 247, 264, 391  
 equation's combinatorics 127, 290  
 equilibrium point 216  
 equilibrium set 466  
 Everett's multiverse 26  
 Euclidean space labeling 372  
 Eulerian circuit 465  
 Eulerian multi-decomposition 72  
 exact labeling 371

**F**

Finsler manifold 263  
 field's combinatorics 296  
 food chain 461

**G**

Gauss mapping 257  
 Gauss-Bonnet theorem 257  
 Gaussian curvature 257  
 generalized fundamental theorem in algebra 331  
 generalized input-output model 489  
 generalized principle of covariance 297  
 G-energy 220  
 geometrical combinatorics 279  
 $\vec{G}$ -flow solutions of equation 322  
 $\vec{G}$ -flow spaces 79, 307  
 geometrical G-system 135  
 global stability of linear equations 173  
 global stability of G-solution 214, 388  
 global stability of non-linear equations 178  
 graph phase 265  
 G-solution of system 8, 62, 121, 170, 213, 469

$\vec{G}$ -synchronized 17  
 gauge field 416  
 gauge invariant principle 417

**H**

Hilbert flow space 12, 347  
 homology group 404

**I**

in-observation 99  
 input-output system 336  
 input-output model 488  
 instable engineering structure 192  
 integral labeled graph 171, 244, 292  
 integral operator on  $\vec{G}$ -flow 319

**K**

Kolmogorov model 463

**L**

labeled graph 60  
 Lagrange function 34  
 L'Hospital's rule on continuity flow 356  
 Liapunov sum-function 182  
 Liapunov prod-function 182  
 lifting of voltage graph 411  
 linear  $\vec{G}$ -flow 312  
 linear operator 81, 317, 341  
 linear space labeling 371  
 Lotka-Volterra model 462

**M**

map geometry without boundary 261  
 map geometry with boundary 261  
 mathematical non-system 111  
 mathematics over graph 63  
 metric pseudo-space 262  
 multi-algebra system 258  
 multigroup 258  
 multifiled 259

multi-metric space 260  
 multiring 259  
 multi-time system 454  
 multi-vector space 259  
 multiverses on equation 68

## N

n-dimensional graph 281  
 non-algebraic system 112  
 non-group 113  
 non-manifold 130  
 non-ring 116  
 non-solvable partial differential equation 197  
 non-space 129  
 norm-stable 43

## O

ordinary  $\vec{G}$ -flow 312  
 out-observation 95  
 $\omega$ -stable 43

## P

parallel decomposition 475  
 parallel differential equations 166  
 parallel linear equations 146, 283, 470  
 parallel observing 59  
 partial differential  $\vec{G}$ -flow 312  
 principal fiber bundle 410  
 prod-stable 176, 178, 215, 294  
 production function 336  
 projective principle 140, 436, 447

## Q

quarks model 57

## R

Reissner-Nordström multi-time system 456  
 Riemannian non-geometry 133  
 Riemannian non-manifold 133

## S

Schrödinger's cat 3, 54  
 Schrödinger's equation 54, 76  
 Schwarzschild multi-time system 455  
 semi-arc 303  
 SIR model 137  
 Smarandache edge m-mean labeling 369  
 Smarandachely denied 145, 162, 233, 260, 288  
 Smarandache geometry 145, 162, 233, 260  
 Smarandache multispace 145, 162  
 Smarandache multisystem 76, 110, 232, 273  
 Smarandache quotient cordial labeling 369  
 Smarandache system 145, 162, 233, 370  
 solvable  $\vec{G}$ -flow space 312  
 spacial graph 59  
 structural equation 427  
 sum-stable 43, 174, 178, 215, 294

## T

tensor field 408, 444  
 Taylor formula on continuity flow 13, 352  
 tensor product of action flow 381

## V

V-solution of equation system 144, 164  
 vector labeling 304  
 v-energy 220  
 voltage graph 411

## W

$\wedge$ -solution of equation system 144, 164



**Dr. Linfan Mao** is a researcher of Chinese Academy of Mathematics and System Science, the president, also a chief-professor of International Academy of Mathematical Combinatorics & Applications (AMCA, USA), the editor-in-chief of the International Journal of Mathematical Combinatorics (ISSN 1937-1055, founded in 2007), an adjunct professor, also a vice director the committee in specialty construction on bidding theory of Beijing University of Civil Engineering and Architecture. He got his PhD in Northern Jiaotong University in 2002, finished his postdoctoral report for Chinese Academy of Sciences in 2005 and won the Albert Nelson Marquis

Lifetime Achievement Award, endorsed by Marquis Who's Who as a leader in the fields of mathematics and engineering in 2017. His research interest is mainly on mathematical combinatorics and Smarandache multispaces with applications to sciences, i.e., mathematics with reality, includes combinatorics, algebra, topology, differential geometry, theoretical physics, complex system, bidding theory, purchasing and circular economy.

**ABSTRACT:** The reality of a thing is its state of existed, exists, or will exist in the world, independent on the understanding of human beings, which implies that the reality holds on by human beings is local or gradual, and mainly the mathematical reality, not the reality of a thing. *Is our mathematical theory can already be used for understanding the reality of all things in the world?* The answer is not because one can not holds on the reality in many fields. For examples, the elementary particle system or ecological system, in which there are no a classical mathematical subfield applicable, i.e., a huge challenge now is appearing in front of modern mathematicians: To establish new mathematics adapting the holds on the reality of things. I research mathematics with reality beginning from 2003 and then published papers on fields, such as those of complex system and network, interaction system, contradictory system, biological populations, non-solvable differential equations, and elementary established an entirely new envelope theory for this objective by flows, i.e., mathematical combinatorics, or mathematics over graphs, which is an appropriated way for understanding the reality of a thing because it is complex, even contradictory. This book collects my mainly papers on mathematics with reality of a thing from 2007 – 2017 and most of them are the plenary or invited reports in international conferences.

