

EXTENDED BANACH \vec{G} -FLOW SPACES ON DIFFERENTIAL EQUATIONS WITH APPLICATIONS

LINFAN MAO

ABSTRACT. Let \mathcal{V} be a Banach space over a field \mathcal{F} . A \vec{G} -flow is a graph \vec{G} embedded in a topological space \mathcal{S} associated with an injective mappings $L : u^v \rightarrow L(u^v) \in \mathcal{V}$ such that $L(u^v) = -L(v^u)$ for $\forall (u, v) \in X(\vec{G})$ holding with conservation laws

$$\sum_{u \in N_G(v)} L(u^v) = \mathbf{0} \quad \text{for } \forall v \in V(\vec{G}),$$

where u^v denotes the semi-arc of $(u, v) \in X(\vec{G})$, which is a mathematical object for things embedded in a topological space. The main purpose of this paper is to extend Banach spaces on topological graphs with operator actions and show all of these extensions are also Banach space with a bijection with a bijection between linear continuous functionals and elements, which enables one to solve linear functional equations in such extended space, particularly, solve algebraic, differential or integral equations on a topological graph, find multi-space solutions on equations, for instance, the Einstein's gravitational equations. A few well-known results in classical mathematics are generalized such as those of the fundamental theorem in algebra, Hilbert and Schmidt's result on integral equations, and the stability of such \vec{G} -flow solutions with applications to ecologically industrial systems are also discussed in this paper.

1. INTRODUCTION

Let \mathcal{V} be a Banach space over a field \mathcal{F} . All graphs \vec{G} , denoted by $(V(\vec{G}), X(\vec{G}))$ considered in this paper are strong-connected without loops. A *topological graph* \vec{G} is an embedding of an oriented graph \vec{G} in a topological space \mathcal{C} . All elements in $V(\vec{G})$ or $X(\vec{G})$ are respectively called vertices or arcs of \vec{G} .

An arc $e = (u, v) \in X(\vec{G})$ can be divided into 2 semi-arcs, i.e., initial semi-arc u^v and end semi-arc v^u , such as those shown in Fig.1 following.

1991 *Mathematics Subject Classification*. 05C78,34A26,35A08,46B25,46E22,51D20.

Key words and phrases. Banach space, topological graph, conservation flow, topological graph, differential flow, multi-space solution of equation, system control.

Submitted Dec. 15, 2014.

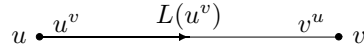
**Fig.1**

All these semi-arcs of a topological graph \vec{G} are denoted by $X_{\frac{1}{2}}(\vec{G})$.

A *vector labeling* \vec{G}^L on \vec{G} is a 1-1 mapping $L: \vec{G} \rightarrow \mathcal{V}$ such that $L: u^v \rightarrow L(u^v) \in \mathcal{V}$ for $\forall u^v \in X_{\frac{1}{2}}(\vec{G})$, such as those shown in Fig.1. For all labelings \vec{G}^L on \vec{G} , define

$$\vec{G}^{L_1} + \vec{G}^{L_2} = \vec{G}^{L_1+L_2} \quad \text{and} \quad \lambda \vec{G}^L = \vec{G}^{\lambda L}.$$

Then, all these vector labelings on \vec{G} naturally form a vector space. Particularly, a \vec{G} -flow on \vec{G} is such a labeling $L: u^v \rightarrow \mathcal{V}$ for $\forall u^v \in X_{\frac{1}{2}}(\vec{G})$ hold with $L(u^v) = -L(v^u)$ and conservation laws

$$\sum_{u \in N_G(v)} L(v^u) = \mathbf{0}$$

for $\forall v \in V(\vec{G})$, where $\mathbf{0}$ is the zero-vector in \mathcal{V} . For example, a conservation law for vertex v in Fig.2 is $-L(v^{u_1}) - L(v^{u_2}) - L(v^{u_3}) + L(v^{u_4}) + L(v^{u_5}) + L(v^{u_6}) = \mathbf{0}$.

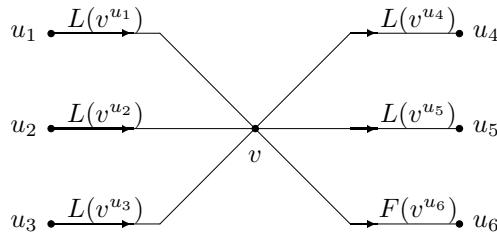
**Fig.2**

Clearly, if $\mathcal{V} = \mathbb{Z}$ and $\mathcal{O} = \{\mathbf{1}\}$, then the \vec{G} -flow \vec{G}^L is nothing else but the network flow $X(\vec{G}) \rightarrow \mathbb{Z}$ on \vec{G} .

Let $\vec{G}^L, \vec{G}^{L_1}, \vec{G}^{L_2}$ be \vec{G} -flows on a topological graph \vec{G} and $\xi \in \mathcal{F}$ a scalar. It is clear that $\vec{G}^{L_1} + \vec{G}^{L_2}$ and $\xi \cdot \vec{G}^L$ are also \vec{G} -flows, which implies that all conservation \vec{G} -flows on \vec{G} also form a linear space over \mathcal{F} with unit $\vec{G}^{\mathbf{0}}$ under operations $+$ and \cdot , denoted by $\vec{G}^{\mathcal{V}}$, where $\vec{G}^{\mathbf{0}}$ is such a \vec{G} -flow with vector $\mathbf{0}$ on u^v for $(u, v) \in X(\vec{G})$, denoted by $\mathbf{0}$ if \vec{G} is clear by the paragraph.

The flow representation for graphs are first discussed in [5], and then applied to differential operators in [6], which has shown its important role both in mathematics and applied sciences. It should be noted that a conservation law naturally determines an autonomous systems in the world. We can also find \vec{G} -flows by solving conservation equations

$$\sum_{u \in N_G(v)} L(v^u) = \mathbf{0}, \quad v \in V(\vec{G}).$$

Such a system of equations is non-solvable in general, only with \vec{G} -flow solutions such as those discussions in references [10]-[19]. Thus we can also introduce \vec{G} -flows by Smarandache multi-system ([21]-[22]). In fact, for any integer $m \geq 1$ let $(\tilde{\Sigma}; \tilde{\mathcal{R}})$ be a Smarandache multi-system consisting of m mathematical systems $(\Sigma_1; \mathcal{R}_1)$, $(\Sigma_2; \mathcal{R}_2)$, \dots , $(\Sigma_m; \mathcal{R}_m)$, different two by two. A *topological structure* $G^L[\tilde{\Sigma}; \tilde{\mathcal{R}}]$ on $(\tilde{\Sigma}; \tilde{\mathcal{R}})$ is inherited by

$$\begin{aligned} V(G^L[\tilde{\Sigma}; \tilde{\mathcal{R}}]) &= \{\Sigma_1, \Sigma_2, \dots, \Sigma_m\}, \\ E(G^L[\tilde{\Sigma}; \tilde{\mathcal{R}}]) &= \{(\Sigma_i, \Sigma_j) \mid \Sigma_i \cap \Sigma_j \neq \emptyset, 1 \leq i \neq j \leq m\} \text{ with labeling} \\ L: \Sigma_i &\rightarrow L(\Sigma_i) = \Sigma_i \quad \text{and} \quad L: (\Sigma_i, \Sigma_j) \rightarrow L(\Sigma_i, \Sigma_j) = \Sigma_i \cap \Sigma_j \end{aligned}$$

for integers $1 \leq i \neq j \leq m$, i.e., a topological vertex-edge labeled graph. Clearly, $G^L[\tilde{\Sigma}; \tilde{\mathcal{R}}]$ is a \vec{G} -flow if $\Sigma_i \cap \Sigma_j = \mathbf{v} \in \mathcal{V}$ for integers $1 \leq i, j \leq m$.

The main purpose of this paper is to establish the theoretical foundation, i.e., extending Banach spaces, particularly, Hilbert spaces on topological graphs with operator actions and show all of these extensions are also Banach space with a bijection between linear continuous functionals and elements, which enables one to solve linear functional equations in such extended space, particularly, solve algebraic or differential equations on a topological graph, i.e., find multi-space solutions for equations, such as those of algebraic equations, the Einstein gravitational equations and integral equations with applications to controlling of ecologically industrial systems. All of these discussions provide new viewpoint for mathematical elements, i.e., mathematical combinatorics.

For terminologies and notations not mentioned in this section, we follow references [1] for functional analysis, [3] and [7] for topological graphs, [4] for linear spaces, [8]-[9], [21]-[22] for Smarandache multi-systems, [3], [20] and [23] for differential equations.

2. \vec{G} -FLOW SPACES

2.1 Existence

Definition 2.1. Let \mathcal{V} be a Banach space. A family V of vectors $\mathbf{v} \in \mathcal{V}$ is conservative if

$$\sum_{\mathbf{v} \in V} \mathbf{v} = \mathbf{0},$$

called a conservative family.

Let \mathcal{V} be a Banach space over a field \mathcal{F} with a basis $\{\alpha_1, \alpha_2, \dots, \alpha_{\dim \mathcal{V}}\}$. Then, for $\mathbf{v} \in V$ there are scalars $x_1^{\mathbf{v}}, x_2^{\mathbf{v}}, \dots, x_{\dim \mathcal{V}}^{\mathbf{v}} \in \mathcal{F}$ such that

$$\mathbf{v} = \sum_{i=1}^{\dim \mathcal{V}} x_i^{\mathbf{v}} \alpha_i.$$

Consequently,

$$\sum_{\mathbf{v} \in V} \sum_{i=1}^{\dim \mathcal{V}} x_i^{\mathbf{v}} \alpha_i = \sum_{i=1}^{\dim \mathcal{V}} \left(\sum_{\mathbf{v} \in V} x_i^{\mathbf{v}} \right) \alpha_i = \mathbf{0}$$

implies that

$$\sum_{\mathbf{v} \in V} x_i^{\mathbf{v}} = 0$$

for integers $1 \leq i \leq \dim \mathcal{V}$.

Conversely, if

$$\sum_{\mathbf{v} \in V} x_i^{\mathbf{v}} = 0, \quad 1 \leq i \leq \dim \mathcal{V},$$

define

$$\mathbf{v}^i = \sum_{i=1}^{\dim \mathcal{V}} x_i^{\mathbf{v}} \alpha_i$$

and $V = \{\mathbf{v}^i, 1 \leq i \leq \dim \mathcal{V}\}$. Clearly, $\sum_{\mathbf{v} \in V} \mathbf{v} = \mathbf{0}$, i.e., V is a family of conservation vectors. Whence, if denoted by $x_i^{\mathbf{v}} = (\mathbf{v}, \alpha_i)$ for $\forall \mathbf{v} \in V$, we therefore get a condition on families of conservation in \mathcal{V} following.

Theorem 2.2. Let \mathcal{V} be a Banach space with a basis $\{\alpha_1, \alpha_2, \dots, \alpha_{\dim \mathcal{V}}\}$. Then, a vector family $V \subset \mathcal{V}$ is conservation if and only if

$$\sum_{\mathbf{v} \in V} (\mathbf{v}, \alpha_i) = 0$$

for integers $1 \leq i \leq \dim \mathcal{V}$.

For example, let $V = \{\mathbf{v}_1, \mathbf{v}_2, \mathbf{v}_3, \mathbf{v}_4\} \subset \mathbb{R}^3$ with

$$\begin{aligned} \mathbf{v}_1 &= (1, 1, 1), & \mathbf{v}_2 &= (-1, 1, 1), \\ \mathbf{v}_3 &= (1, -1, -1), & \mathbf{v}_4 &= (-1, -1, -1) \end{aligned}$$

Then it is a conservation family of vectors in \mathbb{R}^3 .

Clearly, a conservation flow consists of conservation families. The following result establishes its inverse.

Theorem 2.3. A \vec{G} -flow \vec{G}^L exists on \vec{G} if and only if there are conservation families $L(v)$ in a Banach space \mathcal{V} associated an index set V with

$$L(v) = \{L(v^u) \in \mathcal{V} \text{ for some } u \in V\}$$

such that $L(v^u) = -L(u^v)$ and

$$L(v) \cap (-L(u)) = L(v^u) \text{ or } \emptyset.$$

Proof Notice that

$$\sum_{u \in N_G(v)} L(v^u) = \mathbf{0}$$

for $\forall v \in V(\vec{G})$ implies

$$L(v^u) = - \sum_{w \in N_G(v) \setminus \{u\}} L(v^w).$$

Whence, if there is an index set V associated conservation families $L(v)$ with

$$L(v) = \{L(v^u) \in \mathcal{V} \text{ for some } u \in V\}$$

for $\forall v \in V$ such that $L(v^u) = -L(u^v)$ and $L(v) \cap (-L(u)) = L(v^u)$ or \emptyset , define a topological graph \vec{G} by

$$V(\vec{G}) = V \quad \text{and} \quad X(\vec{G}) = \bigcup_{v \in V} \{(v, u) | L(v^u) \in L(v)\}$$

with an orientation $v \rightarrow u$ on its each arcs. Then, it is clear that \vec{G}^L is a \vec{G} -flow by definition.

Conversely, if \vec{G}^L is a \vec{G} -flow, let

$$L(v) = \{L(v^u) \in \mathcal{V} \text{ for } \forall (v, u) \in X(\vec{G})\}$$

for $\forall v \in V(\vec{G})$. Then, it is also clear that $L(v)$, $v \in V(\vec{G})$ are conservation families associated with an index set $V = V(\vec{G})$ such that $L(v, u) = -L(u, v)$ and

$$L(v) \cap (-L(u)) = \begin{cases} L(v^u) & \text{if } (v, u) \in X(\vec{G}) \\ \emptyset & \text{if } (v, u) \notin X(\vec{G}) \end{cases}$$

by definition. □

Theorems 2.2 and 2.3 enables one to get the following result.

Corollary 2.4. There are always existing \vec{G} -flows on a topological graph \vec{G} with weights $\lambda \mathbf{v}$ for $\mathbf{v} \in \mathcal{V}$, particularly, $\lambda_e \alpha_i$ on $\forall e \in X(\vec{G})$ if $|X(\vec{G})| \geq |V(\vec{G})| + 1$.

Proof Let $e = (u, v) \in X(\vec{G})$. By Theorems 2.2 and 2.3, for an integer $1 \leq i \leq \dim \mathcal{V}$, such a \vec{G} -flow exists if and only if the system of linear equations

$$\sum_{u \in V(\vec{G})} \lambda_{(v,u)} = 0, \quad v \in V(\vec{G})$$

is solvable. However, if $|X(\vec{G})| \geq |V(\vec{G})| + 1$, such a system is indeed solvable by linear algebra. □

2.2 \vec{G} -Flow Spaces

Define

$$\|\vec{G}^L\| = \sum_{(u,v) \in X(\vec{G})} \|L(u^v)\|$$

for $\forall \vec{G}^L \in \vec{G}^{\mathcal{V}}$, where $\|L(u^v)\|$ is the norm of $F(u^v)$ in \mathcal{V} . Then

- (1) $\|\vec{G}^L\| \geq 0$ and $\|\vec{G}^L\| = 0$ if and only if $\vec{G}^L = \vec{G}^{\mathbf{0}} = \mathbf{0}$.
- (2) $\|\vec{G}^{\xi L}\| = \xi \|\vec{G}^L\|$ for any scalar ξ .

$$\begin{aligned}
(3) \quad & \|\vec{G}^{L_1} + \vec{G}^{L_2}\| \leq \|\vec{G}^{L_1}\| + \|\vec{G}^{L_2}\| \text{ because of} \\
& \|\vec{G}^{L_1} + \vec{G}^{L_2}\| = \sum_{(u,v) \in X(\vec{G})} \|L_1(u^v) + L_2(u^v)\| \\
& \leq \sum_{(u,v) \in X(\vec{G})} \|L_1(u^v)\| + \sum_{(u,v) \in X(\vec{G})} \|L_2(u^v)\| = \|\vec{G}^{L_1}\| + \|\vec{G}^{L_2}\|.
\end{aligned}$$

Whence, $\|\cdot\|$ is a norm on linear space $\vec{G}^{\mathcal{Y}}$.

Furthermore, if \mathcal{Y} is an inner space with inner product $\langle \cdot, \cdot \rangle$, define

$$\langle \vec{G}^{L_1}, \vec{G}^{L_2} \rangle = \sum_{(u,v) \in X(\vec{G})} \langle L_1(u^v), L_2(u^v) \rangle.$$

Then we know that

$$(4) \quad \langle \vec{G}^L, \vec{G}^L \rangle = \sum_{(u,v) \in X(\vec{G})} \langle L(u^v), L(u^v) \rangle \geq 0 \text{ and } \langle \vec{G}^L, \vec{G}^L \rangle = 0 \text{ if and only}$$

if $L(u^v) = 0$ for $\forall (u, v) \in X(\vec{G})$, i.e., $\vec{G}^L = \mathbf{O}$.

$$(5) \quad \langle \vec{G}^{L_1}, \vec{G}^{L_2} \rangle = \overline{\langle \vec{G}^{L_2}, \vec{G}^{L_1} \rangle} \text{ for } \forall \vec{G}^{L_1}, \vec{G}^{L_2} \in \vec{G}^{\mathcal{Y}} \text{ because of}$$

$$\begin{aligned}
\langle \vec{G}^{L_1}, \vec{G}^{L_2} \rangle &= \sum_{(u,v) \in X(\vec{G})} \langle L_1(u^v), L_2(u^v) \rangle = \sum_{(u,v) \in X(\vec{G})} \overline{\langle L_2(u^v), L_1(u^v) \rangle} \\
&= \overline{\sum_{(u,v) \in X(\vec{G})} \langle L_2(u^v), L_1(u^v) \rangle} = \overline{\langle \vec{G}^{L_2}, \vec{G}^{L_1} \rangle}
\end{aligned}$$

(6) For $\vec{G}^L, \vec{G}^{L_1}, \vec{G}^{L_2} \in \vec{G}^{\mathcal{Y}}$, there is

$$\begin{aligned}
& \langle \lambda \vec{G}^{L_1} + \mu \vec{G}^{L_2}, \vec{G}^L \rangle \\
&= \lambda \langle \vec{G}^{L_1}, \vec{G}^L \rangle + \mu \langle \vec{G}^{L_2}, \vec{G}^L \rangle
\end{aligned}$$

because of

$$\begin{aligned}
& \langle \lambda \vec{G}^{L_1} + \mu \vec{G}^{L_2}, \vec{G}^L \rangle = \langle \vec{G}^{\lambda L_1} + \vec{G}^{\mu L_2}, \vec{G}^L \rangle \\
&= \sum_{(u,v) \in X(\vec{G})} \langle \lambda L_1(u^v) + \mu L_2(u^v), L(u^v) \rangle \\
&= \sum_{(u,v) \in X(\vec{G})} \langle \lambda L_1(u^v), L(u^v) \rangle + \sum_{(u,v) \in X(\vec{G})} \langle \mu L_2(u^v), L(u^v) \rangle \\
&= \langle \vec{G}^{\lambda L_1}, \vec{G}^L \rangle + \langle \vec{G}^{\mu L_2}, \vec{G}^L \rangle \\
&= \lambda \langle \vec{G}^{L_1}, \vec{G}^L \rangle + \mu \langle \vec{G}^{L_2}, \vec{G}^L \rangle.
\end{aligned}$$

Thus, $\vec{G}^{\mathcal{Y}}$ is an inner space also and as the usual, let

$$\|\vec{G}^L\| = \sqrt{\langle \vec{G}^L, \vec{G}^L \rangle}$$

for $\vec{G}^L \in \vec{G}^\mathcal{V}$. Then it is a normed space. Furthermore, we know the following result.

Theorem 2.5. For any topological graph \vec{G} , $\vec{G}^\mathcal{V}$ is a Banach space, and furthermore, if \mathcal{V} is a Hilbert space, $\vec{G}^\mathcal{V}$ is a Hilbert space also.

Proof As shown in the previous, $\vec{G}^\mathcal{V}$ is a linear normed space or inner space if \mathcal{V} is an inner space. We show that it is also complete, i.e., any Cauchy sequence in $\vec{G}^\mathcal{V}$ is converges. In fact, let $\{\vec{G}^{L_n}\}$ be a Cauchy sequence in $\vec{G}^\mathcal{V}$. Thus for any number $\varepsilon > 0$, there always exists an integer $N(\varepsilon)$ such that

$$\|\vec{G}^{L_n} - \vec{G}^{L_m}\| < \varepsilon$$

if $n, m \geq N(\varepsilon)$. By definition,

$$\|L_n(u^v) - L_m(u^v)\| \leq \|\vec{G}^{L_n} - \vec{G}^{L_m}\| < \varepsilon$$

i.e., $\{L_n(u^v)\}$ is also a Cauchy sequence for $\forall(u, v) \in X(\vec{G})$, which is converges on in \mathcal{V} by definition.

Let $L(u^v) = \lim_{n \rightarrow \infty} L_n(u^v)$ for $\forall(u, v) \in X(\vec{G})$. Then it is clear that

$$\lim_{n \rightarrow \infty} \vec{G}^{L_n} = \vec{G}^L.$$

However, we are needed to show $\vec{G}^L \in \vec{G}^\mathcal{V}$. By definition,

$$\sum_{v \in N_G(u)} L_n(u^v) = \mathbf{0}$$

for $\forall u \in V(\vec{G})$ and integers $n \geq 1$. Let $n \rightarrow \infty$ on its both sides. Then

$$\begin{aligned} \lim_{n \rightarrow \infty} \left(\sum_{v \in N_G(u)} L_n(u^v) \right) &= \sum_{v \in N_G(u)} \lim_{n \rightarrow \infty} L_n(u^v) \\ &= \sum_{v \in N_G(u)} L(u^v) = \mathbf{0}. \end{aligned}$$

Thus, $\vec{G}^L \in \vec{G}^\mathcal{V}$. □

Similarly, two conservation \vec{G} -flows \vec{G}^{L_1} and \vec{G}^{L_2} are said to be *orthogonal* if $\langle \vec{G}^{L_1}, \vec{G}^{L_2} \rangle = 0$. The following result characterizes those of orthogonal pairs of conservation \vec{G} -flows.

Theorem 2.6. Let $\vec{G}^{L_1}, \vec{G}^{L_2} \in \vec{G}^\mathcal{V}$. Then \vec{G}^{L_1} is orthogonal to \vec{G}^{L_2} if and only if $\langle L_1(u^v), L_2(u^v) \rangle = 0$ for $\forall(u, v) \in X(\vec{G})$.

Proof Clearly, if $\langle L_1(u^v), L_2(u^v) \rangle = 0$ for $\forall(u, v) \in X(\vec{G})$, then,

$$\langle \vec{G}^{L_1}, \vec{G}^{L_2} \rangle = \sum_{(u,v) \in X(\vec{G})} \langle L_1(u^v), L_2(u^v) \rangle = 0,$$

i.e., \vec{G}^{L_1} is orthogonal to \vec{G}^{L_2} .

Conversely, if \vec{G}^{L_1} is indeed orthogonal to \vec{G}^{L_2} , then

$$\langle \vec{G}^{L_1}, \vec{G}^{L_2} \rangle = \sum_{(u,v) \in X(\vec{G})} \langle L_1(u^v), L_2(u^v) \rangle = 0$$

by definition. We therefore know that $\langle L_1(u^v), L_2(u^v) \rangle = 0$ for $\forall (u, v) \in X(\vec{G})$ because of $\langle L_1(u^v), L_2(u^v) \rangle \geq 0$. \square

Theorem 2.7. Let \mathcal{V} be a Hilbert space with an orthogonal decomposition $\mathcal{V} = \mathbf{V} \oplus \mathbf{V}^\perp$ for a closed subspace $\mathbf{V} \subset \mathcal{V}$. Then there is a decomposition

$$\vec{G}^\mathcal{V} = \tilde{\mathbf{V}} \oplus \tilde{\mathbf{V}}^\perp,$$

where,

$$\begin{aligned} \tilde{\mathbf{V}} &= \{ \vec{G}^{L_1} \in \vec{G}^\mathcal{V} \mid L_1 : X(\vec{G}) \rightarrow \mathbf{V} \} \\ \tilde{\mathbf{V}}^\perp &= \{ \vec{G}^{L_2} \in \vec{G}^\mathcal{V} \mid L_2 : X(\vec{G}) \rightarrow \mathbf{V}^\perp \}, \end{aligned}$$

i.e., for $\forall \vec{G}^L \in \vec{G}^\mathcal{V}$, there is a uniquely decomposition

$$\vec{G}^L = \vec{G}^{L_1} + \vec{G}^{L_2}$$

with $L_1 : X(\vec{G}) \rightarrow \mathbf{V}$ and $L_2 : X(\vec{G}) \rightarrow \mathbf{V}^\perp$.

Proof By definition, $L(u^v) \in \mathcal{V}$ for $\forall (u, v) \in X(\vec{G})$. Thus, there is a decomposition

$$L(u^v) = L_1(u^v) + L_2(u^v)$$

with uniquely determined $L_1(u^v) \in \mathbf{V}$ but $L_2(u^v) \in \mathbf{V}^\perp$.

Let $[\vec{G}^{L_1}]$ and $[\vec{G}^{L_2}]$ be two labeled graphs on \vec{G} with $L_1 : X_{\frac{1}{2}}(\vec{G}) \rightarrow \mathbf{V}$ and $L_2 : X_{\frac{1}{2}}(\vec{G}) \rightarrow \mathbf{V}^\perp$. We need to show that $[\vec{G}^{L_1}], [\vec{G}^{L_2}] \in \langle \vec{G}, \mathcal{V} \rangle$. In fact, the conservation laws show that

$$\sum_{v \in N_G(u)} L(u^v) = \mathbf{0}, \quad i.e., \quad \sum_{v \in N_G(u)} (L_1(u^v) + L_2(u^v)) = \mathbf{0}$$

for $\forall u \in V(\vec{G})$. Consequently,

$$\sum_{v \in N_G(u)} L_1(u^v) + \sum_{v \in N_G(u)} L_2(u^v) = \mathbf{0}.$$

Whence,

$$\begin{aligned}
0 &= \left\langle \sum_{v \in N_G(u)} L_1(u^v) + \sum_{v \in N_G(u)} L_2(u^v), \sum_{v \in N_G(u)} L_1(u^v) + \sum_{v \in N_G(u)} L_2(u^v) \right\rangle \\
&= \left\langle \sum_{v \in N_G(u)} L_1(u^v), \sum_{v \in N_G(u)} L_1(u^v) \right\rangle + \left\langle \sum_{v \in N_G(u)} L_2(u^v), \sum_{v \in N_G(u)} L_2(u^v) \right\rangle \\
&+ \left\langle \sum_{v \in N_G(u)} L_1(u^v), \sum_{v \in N_G(u)} L_2(u^v) \right\rangle + \left\langle \sum_{v \in N_G(u)} L_2(u^v), \sum_{v \in N_G(u)} L_1(u^v) \right\rangle \\
&= \left\langle \sum_{v \in N_G(u)} L_1(u^v), \sum_{v \in N_G(u)} L_1(u^v) \right\rangle + \left\langle \sum_{v \in N_G(u)} L_2(u^v), \sum_{v \in N_G(u)} L_2(u^v) \right\rangle \\
&+ \sum_{v \in N_G(u)} \langle L_1(u^v), L_2(u^v) \rangle + \sum_{v \in N_G(u)} \langle L_2(u^v), L_1(u^v) \rangle \\
&= \left\langle \sum_{v \in N_G(u)} L_1(u^v), \sum_{v \in N_G(u)} L_1(u^v) \right\rangle + \left\langle \sum_{v \in N_G(u)} L_2(u^v), \sum_{v \in N_G(u)} L_2(u^v) \right\rangle.
\end{aligned}$$

Notice that

$$\left\langle \sum_{v \in N_G(u)} L_1(u^v), \sum_{v \in N_G(u)} L_1(u^v) \right\rangle \geq 0, \quad \left\langle \sum_{v \in N_G(u)} L_2(u^v), \sum_{v \in N_G(u)} L_2(u^v) \right\rangle \geq 0.$$

We therefore get that

$$\left\langle \sum_{v \in N_G(u)} L_1(u^v), \sum_{v \in N_G(u)} L_1(u^v) \right\rangle = 0, \quad \left\langle \sum_{v \in N_G(u)} L_2(u^v), \sum_{v \in N_G(u)} L_2(u^v) \right\rangle = 0,$$

i.e.,

$$\sum_{v \in N_G(u)} L_1(u^v) = \mathbf{0} \quad \text{and} \quad \sum_{v \in N_G(u)} L_2(u^v) = \mathbf{0}.$$

Thus, $[\vec{G}^{L_1}], [\vec{G}^{L_2}] \in \vec{G}^\psi$. This completes the proof. \square

2.3 Solvable \vec{G} -Flow Spaces

Let \vec{G}^L be a \vec{G} -flow. If for $\forall v \in V(\vec{G})$, all flows $L(v^u), u \in N_G^+(v) \setminus \{u_0^+\}$ are determined by equations

$$\mathcal{F}_v(L(v^u); L(w^v), w \in N_G^-(v)) = 0$$

unless $L(v^{u_0})$, such a \vec{G} -flow is called *solvable*, and $L(v^{u_0})$ the *co-flow* at vertex v . For example, a solvable \vec{G} -flow is shown in Fig.3.

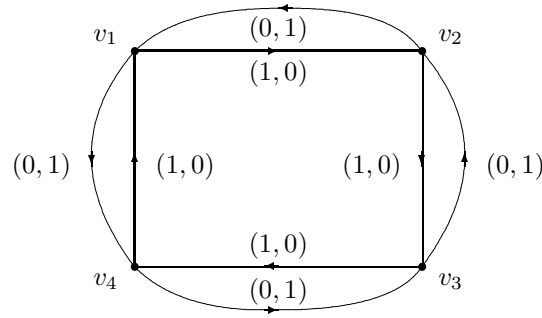

Fig.3

A \vec{G} -flow \vec{G}^L is *linear* if each $L(v^{u^+})$, $u^+ \in N_G^+(v) \setminus \{u_0^+\}$ is determined by

$$L(v^{u^+}) = \sum_{u^- \in N_G^-(v)} a_{u^-} L(u^{-v}),$$

with scalars $a_{u^-} \in \mathcal{F}$ for $\forall v \in V(\vec{G})$ unless $L(v^{u_0^+})$, and is *ordinary* or *partial differential* if $L(v^u)$ is determined by ordinary differential equations

$$L_v \left(\frac{d}{dx_i}; 1 \leq i \leq n \right) (L(v^{u^+}); L(u^{-v}), u^- \in N_G^-(v)) = \mathbf{0}$$

or

$$L_v \left(\frac{\partial}{\partial x_i}; 1 \leq i \leq n \right) (L(v^{u^+}); L(u^{-v}), u^- \in N_G^-(v)) = \mathbf{0}$$

unless $L(v^{u_0^+})$ for $\forall v \in V(\vec{G})$, where, $L_v \left(\frac{d}{dx_i}; 1 \leq i \leq n \right)$, $L_v \left(\frac{\partial}{\partial x_i}; 1 \leq i \leq n \right)$ denote an ordinary or partial differential operators, respectively.

Notice that for a strong-connected graph \vec{G} , there must be a decomposition

$$\vec{G} = \left(\bigcup_{i=1}^{m_1} \vec{C}_i \right) \cup \left(\bigcup_{i=1}^{m_2} \vec{T}_i \right),$$

where \vec{C}_i, \vec{T}_j are respectively directed circuit or path in \vec{G} with $m_1 \geq 1, m_2 \geq 0$. The following result depends on the structure of \vec{G} .

Theorem 2.8. For a strong-connected topological graph \vec{G} with decomposition

$$\vec{G} = \left(\bigcup_{i=1}^{m_1} \vec{C}_i \right) \cup \left(\bigcup_{i=1}^{m_2} \vec{T}_i \right), \quad m_1 \geq 1, m_2 \geq 0,$$

there always exist linear \vec{G} -flows \vec{G}^L , not all flows being zero on \vec{G} .

Proof For an integer $1 \leq k \leq m_1$, let $\vec{C}_k = u_1^k u_2^k \cdots u_{s_k}^k$ and $L(u_i^k u_{i+1}^k) = \mathbf{v}_k$, where $i+1 \equiv (\text{mod } s)$. Similarly, for integers $1 \leq j \leq m_2$, if $\vec{T}_j = w_1^j w_2^j \cdots w_t^j$, let

$L(w_j^t w_{j+1}^t) = \mathbf{0}$. Clearly, the conservation law hold at $\forall v \in V(\vec{G})$ by definition, and each flow $L(u_i^k u_{i+1}^k)$, $i + 1 \equiv (\text{mod } s_k)$ is linear determined by

$$\begin{aligned} L(u_i^k u_{i+1}^k) &= L(u_{i-1}^k u_i^k) + 0 \times \sum_{j \neq i} \sum_{v \in N_{C_j}^-(u_i^k)} L(v^{u_i^k}) + \sum_{j=1}^{m_2} \sum_{v \in N_{T_j}^-(u_i^k)} L(v^{u_i^k}) \\ &= \mathbf{v}_k + \mathbf{0} + \sum_{j=1}^{m_2} \sum_{v \in N_{T_j}^-(u_i^k)} \mathbf{0} = \mathbf{v}_k. \end{aligned}$$

Thus, \vec{G}^L is a linear solvable \vec{G} -flow and not all flows being zero on \vec{G} . \square

All \vec{G} -flows constructed in Theorem 2.8 can be also replaced by vectors dependent on the time t , i.e., $\mathbf{v}(t)$. Furthermore, if $m_1 \geq 2$, there is at least two circuits \vec{C}, \vec{C}' in the decomposition of \vec{G} . Let flows on \vec{C} and \vec{C}' be respectively \mathbf{x} and $\mathbf{f}(\mathbf{x}, t)$. We then know the conservation laws hold for vertices in \vec{G} , and similarly, there are indeed flows on \vec{G} determined by ordinary differential equations.

Theorem 2.9. For a strong-connected topological graph \vec{G} with decomposition

$$\vec{G} = \left(\bigcup_{i=1}^{m_1} \vec{C}_i \right) \cup \left(\bigcup_{i=1}^{m_2} \vec{T}_i \right), \quad m_1 \geq 2, \quad m_2 \geq 0,$$

there always exist ordinary differential \vec{G} -flows \vec{G}^L , not all flows being zero on \vec{G} .

For example, the \vec{G} -flow shown in Fig.4 is an ordinary differential \vec{G} -flow in a vector space if $\dot{\mathbf{x}} = \mathbf{f}(\mathbf{x}, t)$ is solvable with $\mathbf{x}|_{t=t_0} = \mathbf{x}_0$.

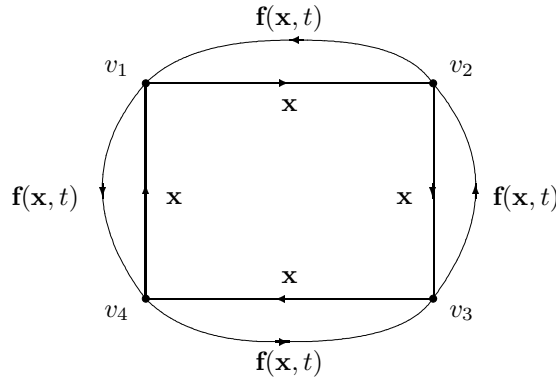

Fig.4

Similarly, we know the existence of non-trivial partial differential \vec{G} -flows. Let $\mathbf{x} = (x_1, x_2, \dots, x_n)$. If

$$\begin{cases} x_i = x_i(t, s_1, s_2, \dots, s_{n-1}) \\ u = u(t, s_1, s_2, \dots, s_{n-1}) \\ p_i = p_i(t, s_1, s_2, \dots, s_{n-1}), \quad i = 1, 2, \dots, n \end{cases}$$

is a solution of system

$$\begin{aligned} \frac{dx_1}{F_{p_1}} &= \frac{dx_2}{F_{p_2}} = \dots = \frac{dx_n}{F_{p_n}} = \frac{du}{\sum_{i=1}^n p_i F_{p_i}} \\ &= -\frac{dp_1}{F_{x_1} + p_1 F_u} = \dots = -\frac{dp_n}{F_{x_n} + p_n F_u} = dt \end{aligned}$$

with initial values

$$\begin{cases} x_{i_0} = x_{i_0}(s_1, s_2, \dots, s_{n-1}), & u_0 = u_0(s_1, s_2, \dots, s_{n-1}) \\ p_{i_0} = p_{i_0}(s_1, s_2, \dots, s_{n-1}), & i = 1, 2, \dots, n \end{cases}$$

such that

$$\begin{cases} F(x_{1_0}, x_{2_0}, \dots, x_{n_0}, u, p_{1_0}, p_{2_0}, \dots, p_{n_0}) = 0 \\ \frac{\partial u_0}{\partial s_j} - \sum_{i=0}^n p_{i_0} \frac{\partial x_{i_0}}{\partial s_j} = 0, & j = 1, 2, \dots, n-1, \end{cases}$$

then it is the solution of Cauchy problem

$$\begin{cases} F(x_1, x_2, \dots, x_n, u, p_1, p_2, \dots, p_n) = 0 \\ x_{i_0} = x_{i_0}(s_1, s_2, \dots, s_{n-1}), & u_0 = u_0(s_1, s_2, \dots, s_{n-1}) \\ p_{i_0} = p_{i_0}(s_1, s_2, \dots, s_{n-1}), & i = 1, 2, \dots, n \end{cases},$$

where $p_i = \frac{\partial u}{\partial x_i}$ and $F_{p_i} = \frac{\partial F}{\partial p_i}$ for integers $1 \leq i \leq n$.

For partial differential equations of second order, the solutions of Cauchy problem on heat or wave equations

$$\begin{cases} \frac{\partial u}{\partial t} = a^2 \sum_{i=1}^n \frac{\partial^2 u}{\partial x_i^2}, & \begin{cases} \frac{\partial^2 u}{\partial t^2} = a^2 \sum_{i=1}^n \frac{\partial^2 u}{\partial x_i^2} \\ u|_{t=0} = \varphi(\mathbf{x}), & \frac{\partial u}{\partial t} \Big|_{t=0} = \psi(\mathbf{x}) \end{cases} \\ u|_{t=0} = \varphi(\mathbf{x}) \end{cases}$$

are respectively known

$$u(\mathbf{x}, t) = \frac{1}{(4\pi t)^{\frac{n}{2}}} \int_{-\infty}^{+\infty} e^{-\frac{(x_1-y_1)^2 + \dots + (x_n-y_n)^2}{4t}} \varphi(y_1, \dots, y_n) dy_1 \dots dy_n$$

for heat equation and

$$u(x_1, x_2, x_3, t) = \frac{\partial}{\partial t} \left(\frac{1}{4\pi a^2 t} \int_{S_{at}^M} \varphi dS \right) + \frac{1}{4\pi a^2 t} \int_{S_{at}^M} \psi dS$$

for wave equations in $n = 3$, where S_{at}^M denotes the sphere centered at $M(x_1, x_2, x_3)$ with radius at . Then, the result following on partial \vec{G} -flows is similarly known to that of Theorem 2.9.

Theorem 2.10. For a strong-connected topological graph \vec{G} with decomposition

$$\vec{G} = \left(\bigcup_{i=1}^{m_1} \vec{C}_i \right) \cup \left(\bigcup_{i=1}^{m_2} \vec{T}_i \right), \quad m_1 \geq 2, \quad m_2 \geq 0,$$

there always exist partial differential \vec{G} -flows \vec{G}^L , not all flows being zero on \vec{G} .

3. OPERATORS ON \vec{G} -FLOW SPACES

3.1 Linear Continuous Operators

Definition 3.1. Let $\mathbf{T} \in \mathcal{O}$ be an operator on Banach space \mathcal{V} over a field \mathcal{F} . An operator $\mathbf{T} : \vec{G}^\mathcal{V} \rightarrow \vec{G}^\mathcal{V}$ is bounded if

$$\|\mathbf{T}(\vec{G}^L)\| \leq \xi \|\vec{G}^L\|$$

for $\forall \vec{G}^L \in \vec{G}^\mathcal{V}$ with a constant $\xi \in [0, \infty)$ and furthermore, is a contractor if

$$\|\mathbf{T}(\vec{G}^{L_1}) - \mathbf{T}(\vec{G}^{L_2})\| \leq \xi \|\vec{G}^{L_1} - \vec{G}^{L_2}\|$$

for $\forall \vec{G}^{L_1}, \vec{G}^{L_2} \in \vec{G}^\mathcal{V}$ with $\xi \in [0, 1)$.

Theorem 3.2. Let $\mathbf{T} : \vec{G}^\mathcal{V} \rightarrow \vec{G}^\mathcal{V}$ be a contractor. Then there is a uniquely conservation G -flow $\vec{G}^L \in \vec{G}^\mathcal{V}$ such that

$$\mathbf{T}(\vec{G}^L) = \vec{G}^L.$$

Proof Let $\vec{G}^{L_0} \in \vec{G}^\mathcal{V}$ be a G -flow. Define a sequence $\{\vec{G}^{L_n}\}$ by

$$\begin{aligned} \vec{G}^{L_1} &= \mathbf{T}(\vec{G}^{L_0}), \\ \vec{G}^{L_2} &= \mathbf{T}(\vec{G}^{L_1}) = \mathbf{T}^2(\vec{G}^{L_0}), \\ &\dots\dots\dots, \\ \vec{G}^{L_n} &= \mathbf{T}(\vec{G}^{L_{n-1}}) = \mathbf{T}^n(\vec{G}^{L_0}), \\ &\dots\dots\dots \end{aligned}$$

We prove $\{\vec{G}^{L_n}\}$ is a Cauchy sequence in $\vec{G}^\mathcal{V}$. Notice that \mathbf{T} is a contractor. For any integer $m \geq 1$, we know that

$$\begin{aligned} \|\vec{G}^{L_{m+1}} - \vec{G}^{L_m}\| &= \|\mathbf{T}(\vec{G}^{L_m}) - \mathbf{T}(\vec{G}^{L_{m-1}})\| \\ &\leq \xi \|\vec{G}^{L_m} - \vec{G}^{L_{m-1}}\| = \|\mathbf{T}(\vec{G}^{L_{m-1}}) - \mathbf{T}(\vec{G}^{L_{m-2}})\| \\ &\leq \xi^2 \|\vec{G}^{L_{m-1}} - \vec{G}^{L_{m-2}}\| \leq \dots \leq \xi^m \|\vec{G}^{L_1} - \vec{G}^{L_0}\|. \end{aligned}$$

Applying the triangle inequality, for integers $m \geq n$ we therefore get that

$$\begin{aligned} & \left\| \vec{G}^{L_m} - \vec{G}^{L_n} \right\| \\ & \leq \left\| \vec{G}^{L_m} - \vec{G}^{L_{m-1}} \right\| + \dots + \left\| \vec{G}^{L_{n-1}} - \vec{G}^{L_n} \right\| \\ & \leq (\xi^m + \xi^{m-1} + \dots + \xi^{n-1}) \times \left\| \vec{G}^{L_1} - \vec{G}^{L_0} \right\| \\ & = \frac{\xi^{n-1} - \xi^m}{1 - \xi} \times \left\| \vec{G}^{L_1} - \vec{G}^{L_0} \right\| \\ & \leq \frac{\xi^{n-1}}{1 - \xi} \times \left\| \vec{G}^{L_1} - \vec{G}^{L_0} \right\| \quad \text{for } 0 < \xi < 1. \end{aligned}$$

Consequently, $\left\| \vec{G}^{L_m} - \vec{G}^{L_n} \right\| \rightarrow 0$ if $m \rightarrow \infty$, $n \rightarrow \infty$. So the sequence $\{\vec{G}^{L_n}\}$ is a Cauchy sequence and converges to \vec{G}^L . Similar to the proof of Theorem 2.5, we know it is a G -flow, i.e., $\vec{G}^L \in \vec{G}^\mathcal{Y}$. Notice that

$$\begin{aligned} \left\| \vec{G}^L - \mathbf{T}(\vec{G}^L) \right\| & \leq \left\| \vec{G}^L - \vec{G}^{L_m} \right\| + \left\| \vec{G}^{L_m} - \mathbf{T}(\vec{G}^L) \right\| \\ & \leq \left\| \vec{G}^L - \vec{G}^{L_m} \right\| + \xi \left\| \vec{G}^{L_{m-1}} - \vec{G}^L \right\|. \end{aligned}$$

Let $m \rightarrow \infty$. For $0 < \xi < 1$, we therefore get that $\left\| \vec{G}^L - \mathbf{T}(\vec{G}^L) \right\| = 0$, i.e., $\mathbf{T}(\vec{G}^L) = \vec{G}^L$.

For the uniqueness, if there is an another conservation G -flow $\vec{G}^{L'} \in \vec{G}^\mathcal{Y}$ holding with $\mathbf{T}(\vec{G}^{L'}) = \vec{G}^L$, by

$$\left\| \vec{G}^L - \vec{G}^{L'} \right\| = \left\| \mathbf{T}(\vec{G}^L) - \mathbf{T}(\vec{G}^{L'}) \right\| \leq \xi \left\| \vec{G}^L - \vec{G}^{L'} \right\|,$$

it can be only happened in the case of $\vec{G}^L = \vec{G}^{L'}$ for $0 < \xi < 1$. \square

Definition 3.3. An operator $\mathbf{T} : \vec{G}^\mathcal{Y} \rightarrow \vec{G}^\mathcal{Y}$ is linear if

$$\mathbf{T}(\lambda \vec{G}^{L_1} + \mu \vec{G}^{L_2}) = \lambda \mathbf{T}(\vec{G}^{L_1}) + \mu \mathbf{T}(\vec{G}^{L_2})$$

for $\forall \vec{G}^{L_1}, \vec{G}^{L_2} \in \vec{G}^\mathcal{Y}$ and $\lambda, \mu \in \mathcal{F}$, and is continuous at a \vec{G} -flow \vec{G}^{L_0} if there always exist a number $\delta(\varepsilon)$ for $\forall \varepsilon > 0$ such that

$$\left\| \mathbf{T}(\vec{G}^L) - \mathbf{T}(\vec{G}^{L_0}) \right\| < \varepsilon \quad \text{if} \quad \left\| \vec{G}^L - \vec{G}^{L_0} \right\| < \delta(\varepsilon).$$

The following result reveals the relation between conceptions of linear continuous with that of linear bounded.

Theorem 3.4. An operator $\mathbf{T} : \vec{G}^\mathcal{Y} \rightarrow \vec{G}^\mathcal{Y}$ is linear continuous if and only if it is bounded.

Proof If \mathbf{T} is bounded, then

$$\left\| \mathbf{T}(\vec{G}^L) - \mathbf{T}(\vec{G}^{L_0}) \right\| = \left\| \mathbf{T}(\vec{G}^L - \vec{G}^{L_0}) \right\| \leq \xi (\vec{G}^L - \vec{G}^{L_0})$$

for an constant $\xi \in [0, \infty)$ and $\forall \vec{G}^L, \vec{G}^{L_0} \in \vec{G}^\mathcal{V}$. Whence, if

$$\|\vec{G}^L - \vec{G}^{L_0}\| < \delta(\varepsilon) \quad \text{with} \quad \delta(\varepsilon) = \frac{\varepsilon}{\xi}, \quad \xi \neq 0,$$

then there must be

$$\|\mathbf{T}(\vec{G}^L - \vec{G}^{L_0})\| < \varepsilon,$$

i.e., \mathbf{T} is linear continuous on $\vec{G}^\mathcal{V}$. However, this is obvious for $\xi = 0$.

Now if \mathbf{T} is linear continuous but unbounded, there exists a sequence $\{\vec{G}^{L_n}\}$ in $\vec{G}^\mathcal{V}$ such that

$$\|\vec{G}^{L_n}\| \geq n \|\vec{G}^{L_n}\|.$$

Let

$$\vec{G}^{L_n^*} = \frac{1}{n \|\vec{G}^{L_n}\|} \times \vec{G}^{L_n}.$$

Then $\|\vec{G}^{L_n^*}\| = \frac{1}{n} \rightarrow 0$, i.e., $\|\mathbf{T}(\vec{G}^{L_n^*})\| \rightarrow 0$ if $n \rightarrow \infty$. However, by definition

$$\begin{aligned} \|\mathbf{T}(\vec{G}^{L_n^*})\| &= \left\| \mathbf{T} \left(\frac{\vec{G}^{L_n}}{n \|\vec{G}^{L_n}\|} \right) \right\| \\ &= \frac{\|\mathbf{T}(\vec{G}^{L_n})\|}{n \|\vec{G}^{L_n}\|} \geq \frac{n \|\vec{G}^{L_n}\|}{n \|\vec{G}^{L_n}\|} = 1, \end{aligned}$$

a contradiction. Thus, \mathbf{T} must be bounded. \square

The following result is a generalization of the representation theorem of Fréchet and Riesz on linear continuous functionals, i.e., $\mathbf{T} : \vec{G}^\mathcal{V} \rightarrow \mathbb{C}$ on \vec{G} -flow space $\vec{G}^\mathcal{V}$, where \mathbb{C} is the complex field.

Theorem 3.5. Let $\mathbf{T} : \vec{G}^\mathcal{V} \rightarrow \mathbb{C}$ be a linear continuous functional. Then there is a unique $\vec{G}^{\hat{L}} \in \vec{G}^\mathcal{V}$ such that

$$\mathbf{T}(\vec{G}^L) = \langle \vec{G}^L, \vec{G}^{\hat{L}} \rangle$$

for $\forall \vec{G}^L \in \vec{G}^\mathcal{V}$.

Proof Define a closed subset of $\vec{G}^\mathcal{V}$ by

$$\mathcal{N}(\mathbf{T}) = \left\{ \vec{G}^L \in \vec{G}^\mathcal{V} \mid \mathbf{T}(\vec{G}^L) = 0 \right\}$$

for the linear continuous functional \mathbf{T} . If $\mathcal{N}(\mathbf{T}) = \vec{G}^\mathcal{V}$, i.e., $\mathbf{T}(\vec{G}^L) = 0$ for $\forall \vec{G}^L \in \vec{G}^\mathcal{V}$, choose $\vec{G}^{\hat{L}} = \mathbf{0}$. We then easily obtain the identity

$$\mathbf{T}(\vec{G}^L) = \langle \vec{G}^L, \vec{G}^{\hat{L}} \rangle.$$

Whence, we assume that $\mathcal{N}(\mathbf{T}) \neq \vec{G}^\mathcal{V}$. In this case, there is an orthogonal decomposition

$$\vec{G}^\mathcal{V} = \mathcal{N}(\mathbf{T}) \oplus \mathcal{N}^\perp(\mathbf{T})$$

with $\mathcal{N}(\mathbf{T}) \neq \{\mathbf{0}\}$ and $\mathcal{N}^\perp(\mathbf{T}) \neq \{\mathbf{0}\}$.

Choose a \vec{G} -flow $\vec{G}^{L_0} \in \mathcal{N}^\perp(\mathbf{T})$ with $\vec{G}^{L_0} \neq \mathbf{O}$ and define

$$\vec{G}^{L^*} = (\mathbf{T}(\vec{G}^L)) \vec{G}^{L_0} - (\mathbf{T}(\vec{G}^{L_0})) \vec{G}^L$$

for $\forall \vec{G}^L \in \vec{G}^\mathcal{V}$. Calculation shows that

$$\mathbf{T}(\vec{G}^{L^*}) = (\mathbf{T}(\vec{G}^L)) \mathbf{T}(\vec{G}^{L_0}) - (\mathbf{T}(\vec{G}^{L_0})) \mathbf{T}(\vec{G}^L) = 0,$$

i.e., $\vec{G}^{L^*} \in \mathcal{N}(\mathbf{T})$. We therefore get that

$$\begin{aligned} 0 &= \langle \vec{G}^{L^*}, \vec{G}^{L_0} \rangle \\ &= \langle (\mathbf{T}(\vec{G}^L)) \vec{G}^{L_0} - (\mathbf{T}(\vec{G}^{L_0})) \vec{G}^L, \vec{G}^{L_0} \rangle \\ &= \mathbf{T}(\vec{G}^L) \langle \vec{G}^{L_0}, \vec{G}^{L_0} \rangle - \mathbf{T}(\vec{G}^{L_0}) \langle \vec{G}^L, \vec{G}^{L_0} \rangle. \end{aligned}$$

Notice that $\langle \vec{G}^{L_0}, \vec{G}^{L_0} \rangle = \|\vec{G}^{L_0}\|^2 \neq 0$. We find that

$$\mathbf{T}(\vec{G}^L) = \frac{\mathbf{T}(\vec{G}^{L_0})}{\|\vec{G}^{L_0}\|^2} \langle \vec{G}^L, \vec{G}^{L_0} \rangle = \left\langle \vec{G}^L, \frac{\overline{\mathbf{T}(\vec{G}^{L_0})}}{\|\vec{G}^{L_0}\|^2} \vec{G}^{L_0} \right\rangle.$$

Let

$$\vec{G}^{\hat{L}} = \frac{\overline{\mathbf{T}(\vec{G}^{L_0})}}{\|\vec{G}^{L_0}\|^2} \vec{G}^{L_0} = \vec{G}^{\lambda L_0},$$

where $\lambda = \frac{\overline{\mathbf{T}(\vec{G}^{L_0})}}{\|\vec{G}^{L_0}\|^2}$. We consequently get that $\mathbf{T}(\vec{G}^L) = \langle \vec{G}^L, \vec{G}^{\hat{L}} \rangle$.

Now if there is another $\vec{G}^{\hat{L}'} \in \vec{G}^\mathcal{V}$ such that $\mathbf{T}(\vec{G}^L) = \langle \vec{G}^L, \vec{G}^{\hat{L}'} \rangle$ for $\forall \vec{G}^L \in \vec{G}^\mathcal{V}$, there must be $\langle \vec{G}^L, \vec{G}^{\hat{L}} - \vec{G}^{\hat{L}'} \rangle = 0$ by definition. Particularly, let $\vec{G}^L = \vec{G}^{\hat{L}} - \vec{G}^{\hat{L}'}$. We know that

$$\|\vec{G}^{\hat{L}} - \vec{G}^{\hat{L}'}\| = \langle \vec{G}^{\hat{L}} - \vec{G}^{\hat{L}'}, \vec{G}^{\hat{L}} - \vec{G}^{\hat{L}'} \rangle = 0,$$

which implies that $\vec{G}^{\hat{L}} - \vec{G}^{\hat{L}'} = \mathbf{O}$, i.e., $\vec{G}^{\hat{L}} = \vec{G}^{\hat{L}'}$. \square

3.2 Differential and Integral Operators

Let \mathcal{V} be Hilbert space consisting of measurable functions $f(x_1, x_2, \dots, x_n)$ on a set

$$\Delta = \{\mathbf{x} = (x_1, x_2, \dots, x_n) \in \mathbb{R}^n \mid a_i \leq x_i \leq b_i, 1 \leq i \leq n\},$$

i.e., the functional space $L^2[\Delta]$, with inner product

$$\langle f(\mathbf{x}), g(\mathbf{x}) \rangle = \int_{\Delta} \overline{f(\mathbf{x})} g(\mathbf{x}) d\mathbf{x} \quad \text{for } f(\mathbf{x}), g(\mathbf{x}) \in L^2[\Delta]$$

and \vec{G}^ν its \vec{G} -extension on a topological graph \vec{G} . The *differential operator* and *integral operators*

$$D = \sum_{i=1}^n a_i \frac{\partial}{\partial x_i} \quad \text{and} \quad \int_{\Delta}, \quad \overline{\int}_{\Delta}$$

on \vec{G}^ν are respectively defined by

$$D\vec{G}^L = \vec{G}^{DL(u^\nu)}$$

and

$$\begin{aligned} \int_{\Delta} \vec{G}^L &= \int_{\Delta} K(\mathbf{x}, \mathbf{y}) \vec{G}^{L[\mathbf{y}]} d\mathbf{y} = \vec{G}^{\int_{\Delta} K(\mathbf{x}, \mathbf{y}) L(u^\nu)[\mathbf{y}] d\mathbf{y}}, \\ \overline{\int}_{\Delta} \vec{G}^L &= \int_{\Delta} \overline{K(\mathbf{x}, \mathbf{y})} \vec{G}^{L[\mathbf{y}]} d\mathbf{y} = \vec{G}^{\int_{\Delta} \overline{K(\mathbf{x}, \mathbf{y})} L(u^\nu)[\mathbf{y}] d\mathbf{y}} \end{aligned}$$

for $\forall(u, v) \in X(\vec{G})$, where $a_i, \frac{\partial a_i}{\partial x_j} \in \mathbb{C}^0(\Delta)$ for integers $1 \leq i, j \leq n$ and $K(\mathbf{x}, \mathbf{y}) : \Delta \times \Delta \rightarrow \mathbb{C} \in L^2(\Delta \times \Delta, \mathbb{C})$ with

$$\int_{\Delta \times \Delta} K(\mathbf{x}, \mathbf{y}) dx dy < \infty.$$

Such integral operators are usually called adjoint for $\overline{\int}_{\Delta} = \int_{\Delta}$ by $\overline{\overline{K(\mathbf{x}, \mathbf{y})}} = K(\mathbf{x}, \mathbf{y})$. Clearly, for $\vec{G}^{L_1}, \vec{G}^{L_2} \in \vec{G}^\nu$ and $\lambda, \mu \in \mathcal{F}$,

$$\begin{aligned} D\left(\lambda \vec{G}^{L_1(u^\nu)} + \mu \vec{G}^{L_2(u^\nu)}\right) &= D\left(\vec{G}^{\lambda L_1(u^\nu) + \mu L_2(u^\nu)}\right) = \vec{G}^{D(\lambda L_1(u^\nu) + \mu L_2(u^\nu))} \\ &= \vec{G}^{D(\lambda L_1(u^\nu)) + D(\mu L_2(u^\nu))} = \vec{G}^{D(\lambda L_1(u^\nu))} + \vec{G}^{D(\mu L_2(u^\nu))} \\ &= D\left(\vec{G}^{(\lambda L_1(u^\nu))} + \vec{G}^{(\mu L_2(u^\nu))}\right) = \lambda D\left(\vec{G}^{L_1(u^\nu)}\right) + D\left(\mu \vec{G}^{L_2(u^\nu)}\right) \end{aligned}$$

for $\forall(u, v) \in X(\vec{G})$, i.e.,

$$D\left(\lambda \vec{G}^{L_1} + \mu \vec{G}^{L_2}\right) = \lambda D\vec{G}^{L_1} + \mu D\vec{G}^{L_2}.$$

Similarly, we know also that

$$\begin{aligned} \int_{\Delta} \left(\lambda \vec{G}^{L_1} + \mu \vec{G}^{L_2}\right) &= \lambda \int_{\Delta} \vec{G}^{L_1} + \mu \int_{\Delta} \vec{G}^{L_2}, \\ \overline{\int}_{\Delta} \left(\lambda \vec{G}^{L_1} + \mu \vec{G}^{L_2}\right) &= \lambda \overline{\int}_{\Delta} \vec{G}^{L_1} + \mu \overline{\int}_{\Delta} \vec{G}^{L_2}. \end{aligned}$$

Thus, operators D, \int_{Δ} and $\overline{\int}_{\Delta}$ are all linear on \vec{G}^ν .

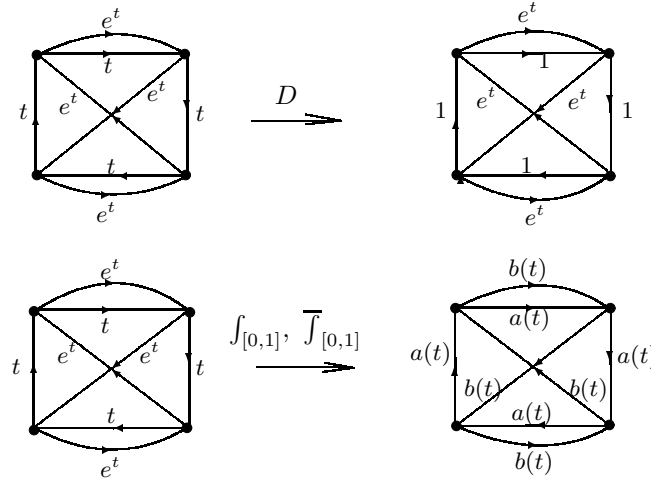

Fig.5

For example, let $f(t) = t$, $g(t) = e^t$, $K(t, \tau) = t^2 + \tau^2$ for $\Delta = [0, 1]$ and let \vec{G}^L be the \vec{G} -flow shown on the left in Fig.6. Then, we know that $Df = 1, Dg = e^t$,

$$\int_0^1 K(t, \tau) f(\tau) d\tau = \int_0^1 \overline{K(t, \tau)} f(\tau) d\tau = \int_0^1 (t^2 + \tau^2) \tau d\tau = \frac{t^2}{2} + \frac{1}{4} = a(t),$$

$$\int_0^1 K(t, \tau) g(\tau) d\tau = \int_0^1 \overline{K(t, \tau)} g(\tau) d\tau = \int_0^1 (t^2 + \tau^2) e^\tau d\tau = (e - 1)t^2 + e - 2 = b(t)$$

and the actions $D\vec{G}^L, \int_{[0,1]} \vec{G}^L$ and $\overline{\int_{[0,1]} \vec{G}^L}$ are shown on the right in Fig.5.

Furthermore, we know that both of them are injections on $\vec{G}^\mathcal{V}$.

Theorem 3.6. $D: \vec{G}^\mathcal{V} \rightarrow \vec{G}^\mathcal{V}$ and $\int_\Delta: \vec{G}^\mathcal{V} \rightarrow \vec{G}^\mathcal{V}$.

Proof For $\forall \vec{G}^L \in \vec{G}^\mathcal{V}$, we are needed to show that $D\vec{G}^L$ and $\int_\Delta \vec{G}^L \in \vec{G}^\mathcal{V}$, i.e., the conservation laws

$$\sum_{v \in N_G(u)} DL(u^v) = \mathbf{0} \quad \text{and} \quad \sum_{v \in N_G(u)} \int_\Delta L(u^v) = \mathbf{0}$$

hold with $\forall v \in V(\vec{G})$.

However, because of $\vec{G}^{L(u^v)} \in \vec{G}^\mathcal{V}$, there must be

$$\sum_{v \in N_G(u)} L(u^v) = \mathbf{0} \quad \text{for} \quad \forall v \in V(\vec{G}),$$

we immediately know that

$$\mathbf{0} = D \left(\sum_{v \in N_G(u)} L(u^v) \right) = \sum_{v \in N_G(u)} DL(u^v)$$

and

$$\mathbf{0} = \int_{\Delta} \left(\sum_{v \in N_G(u)} L(u^v) \right) = \sum_{v \in N_G(u)} \int_{\Delta} L(u^v)$$

for $\forall v \in V(\vec{G})$. □

4. \vec{G} -FLOW SOLUTIONS OF EQUATIONS

As we mentioned, all G -solutions of non-solvable systems on algebraic, ordinary or partial differential equations determined in [13]-[19] are in fact \vec{G} -flows. We show there are also \vec{G} -flow solutions for solvable equations, which implies that the \vec{G} -flow solutions are fundamental for equations.

4.1 Linear Equations

Let \mathcal{V} be a field $(\mathcal{F}; +, \cdot)$. We can further define

$$\vec{G}^{L_1} \circ \vec{G}^{L_2} = \vec{G}^{L_1 \cdot L_2}$$

with $L_1 \cdot L_2(u^v) = L_1(u^v) \cdot L_2(u^v)$ for $\forall(u, v) \in X(\vec{G})$. Then it can be verified easily that $\vec{G}^{\mathcal{F}}$ is also a field $(\vec{G}^{\mathcal{F}}; +, \circ)$ with a subfield $\widehat{\mathcal{F}}$ isomorphic to \mathcal{F} if the conservation laws is not emphasized, where

$$\widehat{\mathcal{F}} = \left\{ \vec{G}^L \in \vec{G}^{\mathcal{F}} \mid L(u^v) \text{ is constant in } \mathcal{F} \text{ for } \forall(u, v) \in X(\vec{G}) \right\}.$$

Clearly, $\vec{G}^{\mathcal{F}} \simeq \mathcal{F}^{|E(\vec{G})|}$. Thus $|\vec{G}^{\mathcal{F}}| = p^n |E(\vec{G})|$ if $|\mathcal{F}| = p^n$, where p is a prime number. For this \mathcal{F} -extension on \vec{G} , the linear equation

$$aX = \vec{G}^L$$

is uniquely solvable for $X = \vec{G}^{a^{-1}L}$ in $\vec{G}^{\mathcal{F}}$ if $0 \neq a \in \mathcal{F}$. Particularly, if one views an element $b \in \mathcal{F}$ as $b = \vec{G}^L$ if $L(u^v) = b$ for $(u, v) \in X(\vec{G})$ and $0 \neq a \in \mathcal{F}$, then an algebraic equation

$$ax = b$$

in \mathcal{F} also is an equation in $\vec{G}^{\mathcal{F}}$ with a solution $x = \vec{G}^{a^{-1}L}$ such as those shown in Fig.6 for $\vec{G} = \vec{C}_4$, $a = 3$, $b = 5$ following.

with initial values $X|_{t=t_0}$, and know the result following.

Theorem 4.4. For $\forall \vec{G}^{L'} \in \vec{G}^{\mathcal{V}}$ and a non-zero constant c in \mathbb{R} , the Cauchy problems on differential equations

$$\frac{\partial X}{\partial t} = c^2 \sum_{i=1}^n \frac{\partial^2 X}{\partial x_i^2}$$

with initial value $X|_{t=t_0} = \vec{G}^{L'} \in \vec{G}^{\mathcal{V}}$ is solvable in $\vec{G}^{\mathcal{V}}$ if $L'(u^v)$ is continuous and bounded in \mathbb{R}^n for $\forall (u, v) \in X(\vec{G})$.

Proof For $(u, v) \in X(\vec{G})$, the Cauchy problem on the semi-arc u^v appears as

$$\frac{\partial u}{\partial t} = c^2 \sum_{i=1}^n \frac{\partial^2 u}{\partial x_i^2}$$

with initial value $u|_{t=0} = L'(u^v)(\mathbf{x})$ if $X = \vec{G}^F$. According to the theory of partial differential equations, we know that

$$F(u^v)(\mathbf{x}, t) = \frac{1}{(4\pi t)^{\frac{n}{2}}} \int_{-\infty}^{+\infty} e^{-\frac{(x_1-y_1)^2+\dots+(x_n-y_n)^2}{4t}} L'(u^v)(y_1, \dots, y_n) dy_1 \cdots dy_n.$$

Labeling the semi-arc u^v by $F(u^v)(\mathbf{x}, t)$ for $\forall (u, v) \in X(\vec{G})$, we get a labeled graph \vec{G}^F on \vec{G} . We prove $\vec{G}^F \in \vec{G}^{\mathcal{V}}$.

By assumption, $\vec{G}^{L'} \in \vec{G}^{\mathcal{V}}$, i.e., for $\forall u \in V(\vec{G})$,

$$\sum_{v \in N_G(u)} L'(u^v)(\mathbf{x}) = \mathbf{0},$$

we know that

$$\begin{aligned} & \sum_{v \in N_G(u)} F(u^v)(\mathbf{x}, t) \\ &= \sum_{v \in N_G(u)} \frac{1}{(4\pi t)^{\frac{n}{2}}} \int_{-\infty}^{+\infty} e^{-\frac{(x_1-y_1)^2+\dots+(x_n-y_n)^2}{4t}} L'(u^v)(y_1, \dots, y_n) dy_1 \cdots dy_n \\ &= \frac{1}{(4\pi t)^{\frac{n}{2}}} \int_{-\infty}^{+\infty} e^{-\frac{(x_1-y_1)^2+\dots+(x_n-y_n)^2}{4t}} \left(\sum_{v \in N_G(u)} L'(u^v)(y_1, \dots, y_n) \right) dy_1 \cdots dy_n \\ &= \frac{1}{(4\pi t)^{\frac{n}{2}}} \int_{-\infty}^{+\infty} e^{-\frac{(x_1-y_1)^2+\dots+(x_n-y_n)^2}{4t}} (\mathbf{0}) dy_1 \cdots dy_n = \mathbf{0} \end{aligned}$$

for $\forall u \in V(\vec{G})$. Therefore, $\vec{G}^F \in \vec{G}^{\mathcal{V}}$ and

$$\frac{\partial X}{\partial t} = c^2 \sum_{i=1}^n \frac{\partial^2 X}{\partial x_i^2}$$

with initial value $X|_{t=t_0} = \vec{G}^{L'} \in \vec{G}^{\mathcal{V}}$ is solvable in $\vec{G}^{\mathcal{V}}$. \square

Similarly, we can also get a result on Cauchy problem on 3-dimensional wave equation in $\vec{G}^{\mathcal{V}}$ following.

Theorem 4.5. For $\forall \vec{G}^{L'} \in \vec{G}^{\mathcal{Y}}$ and a non-zero constant c in \mathbb{R} , the Cauchy problems on differential equations

$$\frac{\partial^2 X}{\partial t^2} = c^2 \left(\frac{\partial^2 X}{\partial x_1^2} + \frac{\partial^2 X}{\partial x_2^2} + \frac{\partial^2 X}{\partial x_3^2} \right)$$

with initial value $X|_{t=t_0} = \vec{G}^{L'} \in \vec{G}^{\mathcal{Y}}$ is solvable in $\vec{G}^{\mathcal{Y}}$ if $L'(u^v)$ is continuous and bounded in \mathbb{R}^n for $\forall (u, v) \in X(\vec{G})$.

For an integral kernel $K(\mathbf{x}, \mathbf{y})$, the two subspaces $\mathcal{N}, \mathcal{N}^* \subset L^2[\Delta]$ are determined by

$$\begin{aligned} \mathcal{N} &= \left\{ \phi(\mathbf{x}) \in L^2[\Delta] \mid \int_{\Delta} K(\mathbf{x}, \mathbf{y}) \phi(\mathbf{y}) d\mathbf{y} = \phi(\mathbf{x}) \right\}, \\ \mathcal{N}^* &= \left\{ \varphi(\mathbf{x}) \in L^2[\Delta] \mid \int_{\Delta} \overline{K(\mathbf{x}, \mathbf{y})} \varphi(\mathbf{y}) d\mathbf{y} = \varphi(\mathbf{x}) \right\}. \end{aligned}$$

Then we know the result following.

Theorem 4.6. For $\forall G^L \in \vec{G}^{\mathcal{Y}}$, if $\dim \mathcal{N} = 0$, then the integral equation

$$\vec{G}^X - \int_{\Delta} \vec{G}^X = G^L$$

is solvable in $\vec{G}^{\mathcal{Y}}$ with $\mathcal{Y} = L^2[\Delta]$ if and only if

$$\langle \vec{G}^L, \vec{G}^{L'} \rangle = 0, \quad \forall \vec{G}^{L'} \in \mathcal{N}^*.$$

Proof For $\forall (u, v) \in X(\vec{G})$

$$\vec{G}^X - \int_{\Delta} \vec{G}^X = G^L \quad \text{and} \quad \langle \vec{G}^L, \vec{G}^{L'} \rangle = 0, \quad \forall \vec{G}^{L'} \in \mathcal{N}^*$$

on the semi-arc u^v respectively appear as

$$F(\mathbf{x}) - \int_{\Delta} K(\mathbf{x}, \mathbf{y}) F(\mathbf{y}) d\mathbf{y} = L(u^v)[\mathbf{x}]$$

if $X(u^v) = F(\mathbf{x})$ and

$$\int_{\Delta} \overline{L(u^v)[\mathbf{x}]} L'(u^v)[\mathbf{x}] d\mathbf{x} = \mathbf{0} \quad \text{for } \forall \vec{G}^{L'} \in \mathcal{N}^*.$$

Applying Hilbert and Schmidt's theorem ([20]) on integral equation, we know the integral equation

$$F(\mathbf{x}) - \int_{\Delta} K(\mathbf{x}, \mathbf{y}) F(\mathbf{y}) d\mathbf{y} = L(u^v)[\mathbf{x}]$$

is solvable in $L^2[\Delta]$ if and only if

$$\int_{\Delta} \overline{L(u^v)[\mathbf{x}]} L'(u^v)[\mathbf{x}] d\mathbf{x} = \mathbf{0}$$

for $\forall \vec{G}^{L'} \in \mathcal{N}^*$. Thus, there are functions $F(\mathbf{x}) \in L^2[\Delta]$ hold for the integral equation

$$F(\mathbf{x}) - \int_{\Delta} K(\mathbf{x}, \mathbf{y}) F(\mathbf{y}) d\mathbf{y} = L(u^v)[\mathbf{x}]$$

for $\forall(u, v) \in X(\vec{G})$ in this case.

For $\forall u \in V(\vec{G})$, it is clear that

$$\sum_{v \in N_G(u)} \left(F(u^v)[\mathbf{x}] - \int_{\Delta} \mathbf{K}(\mathbf{x}, \mathbf{y}) \mathbf{F}(\mathbf{u}^v)[\mathbf{x}] \right) = \sum_{v \in N_G(u)} L(u^v)[\mathbf{x}] = \mathbf{0},$$

which implies that,

$$\int_{\Delta} K(\mathbf{x}, \mathbf{y}) \left(\sum_{v \in N_G(u)} F(u^v)[\mathbf{x}] \right) = \sum_{v \in N_G(u)} F(u^v)[\mathbf{x}].$$

Thus,

$$\sum_{v \in N_G(u)} F(u^v)[\mathbf{x}] \in \mathcal{N}.$$

However, if $\dim \mathcal{N} = 0$, there must be

$$\sum_{v \in N_G(u)} F(u^v)[\mathbf{x}] = \mathbf{0}$$

for $\forall u \in V(\vec{G})$, i.e., $\vec{G}^F \in \vec{G}^{\mathcal{Y}}$. Whence, if $\dim \mathcal{N} = 0$, the integral equation

$$\vec{G}^X - \int_{\Delta} \vec{G}^X = G^L$$

is solvable in $\vec{G}^{\mathcal{Y}}$ with $\mathcal{Y} = L^2[\Delta]$ if and only if

$$\langle \vec{G}^L, \vec{G}^{L'} \rangle = 0, \quad \forall \vec{G}^{L'} \in \mathcal{N}^*.$$

This completes the proof. □

Theorem 4.7. Let the integral kernel $K(\mathbf{x}, \mathbf{y}) : \Delta \times \Delta \rightarrow \mathbb{C} \in L^2(\Delta \times \Delta)$ be given with

$$\int_{\Delta \times \Delta} |K(\mathbf{x}, \mathbf{y})|^2 d\mathbf{x}d\mathbf{y} > 0, \quad \dim \mathcal{N} = 0 \quad \text{and} \quad \overline{K(\mathbf{x}, \mathbf{y})} = K(\mathbf{x}, \mathbf{y})$$

for almost all $(\mathbf{x}, \mathbf{y}) \in \Delta \times \Delta$. Then there is a finite or countably infinite system \vec{G} -flows $\{\vec{G}^{L_i}\}_{i=1,2,\dots} \subset L^2(\Delta, \mathbb{C})$ with associate real numbers $\{\lambda_i\}_{i=1,2,\dots} \subset \mathbb{R}$ such that the integral equations

$$\int_{\Delta} K(\mathbf{x}, \mathbf{y}) \vec{G}^{L_i}[\mathbf{y}] d\mathbf{y} = \lambda_i \vec{G}^{L_i}[\mathbf{x}]$$

hold with integers $i = 1, 2, \dots$, and furthermore,

$$|\lambda_1| \geq |\lambda_2| \geq \dots \geq 0 \quad \text{and} \quad \lim_{i \rightarrow \infty} \lambda_i = 0.$$

Proof Notice that the integral equations

$$\int_{\Delta} K(\mathbf{x}, \mathbf{y}) \vec{G}^{L_i}[\mathbf{y}] d\mathbf{y} = \lambda_i \vec{G}^{L_i}[\mathbf{x}]$$

is appeared as

$$\int_{\Delta} K(\mathbf{x}, \mathbf{y}) L_i(u^v)[\mathbf{y}] d\mathbf{y} = \lambda_i \mathbf{L}_i(\mathbf{u}^v)[\mathbf{x}]$$

on $(u, v) \in X(\vec{G})$. By the spectral theorem of Hilbert and Schmidt ([20]), there is indeed a finite or countably system of functions $\{L_i(u^v)[\mathbf{x}]\}_{i=1,2,\dots}$ hold with this integral equation, and furthermore,

$$|\lambda_1| \geq |\lambda_2| \geq \dots \geq 0 \quad \text{with} \quad \lim_{i \rightarrow \infty} \lambda_i = 0.$$

Similar to the proof of Theorem 4.5, if $\dim \mathcal{N} = 0$, we know that

$$\sum_{v \in N_G(u)} L_i(u^v)[\mathbf{x}] = \mathbf{0}$$

for $\forall u \in V(\vec{G})$, i.e., $\vec{G}L_i \in \vec{G}^{\mathcal{V}}$ for integers $i = 1, 2, \dots$. □

4.2 Non-linear Equations

If \vec{G} is strong-connected with a special structure, we can get a general result on \vec{G} -solutions of equations, including non-linear equations following.

Theorem 4.8. If the topological graph \vec{G} is strong-connected with circuit decomposition

$$\vec{G} = \bigcup_{i=1}^l \vec{C}_i$$

such that $L(u^v) = L_i(\mathbf{x})$ for $\forall (u, v) \in X(\vec{C}_i)$, $1 \leq i \leq l$ and the Cauchy problem

$$\begin{cases} \mathcal{F}_i(\mathbf{x}, u, u_{x_1}, \dots, u_{x_n}, u_{x_1x_2}, \dots) = 0 \\ u|_{\mathbf{x}_0} = L_i(\mathbf{x}) \end{cases}$$

is solvable in a Hilbert space \mathcal{V} on domain $\Delta \subset \mathbb{R}^n$ for integers $1 \leq i \leq l$, then the Cauchy problem

$$\begin{cases} \mathcal{F}_i(\mathbf{x}, X, X_{x_1}, \dots, X_{x_n}, X_{x_1x_2}, \dots) = 0 \\ X|_{\mathbf{x}_0} = \vec{G}L \end{cases}$$

such that $L(u^v) = L_i(\mathbf{x})$ for $\forall (u, v) \in X(\vec{C}_i)$ is solvable for $X \in \vec{G}^{\mathcal{V}}$.

Proof Let $X = \vec{G}L_{u(\mathbf{x})}$ with $L_{u(\mathbf{x})}(u^v) = u(\mathbf{x})$ for $(u, v) \in X(\vec{G})$. Notice that the Cauchy problem

$$\begin{cases} \mathcal{F}_i(\mathbf{x}, X, X_{x_1}, \dots, X_{x_n}, X_{x_1x_2}, \dots) = 0 \\ X|_{\mathbf{x}_0} = G^L \end{cases}$$

then appears as

$$\begin{cases} \mathcal{F}_i(\mathbf{x}, u, u_{x_1}, \dots, u_{x_n}, u_{x_1x_2}, \dots) = 0 \\ u|_{\mathbf{x}_0} = L_i(\mathbf{x}) \end{cases}$$

on the semi-arc u^v for $(u, v) \in X(\vec{G})$, which is solvable by assumption. Whence, there exists solution $u(u^v)(\mathbf{x})$ holding with

$$\begin{cases} \mathcal{F}_i(\mathbf{x}, u, u_{x_1}, \dots, u_{x_n}, u_{x_1x_2}, \dots) = 0 \\ u|_{\mathbf{x}_0} = L_i(\mathbf{x}) \end{cases}$$

Let $\vec{G}^{L_{u(\mathbf{x})}}$ be a labeling on \vec{G} with $u(u^v)(\mathbf{x})$ on u^v for $\forall(u, v) \in X(\vec{G})$. We show that $\vec{G}^{L_{u(\mathbf{x})}} \in \vec{G}^\mathcal{V}$. Notice that

$$\vec{G} = \bigcup_{i=1}^l \vec{C}_i$$

and all flows on \vec{C}_i is the same, i.e., the solution $u(u^v)(\mathbf{x})$. Clearly, it is holden with conservation on each vertex in \vec{C}_i for integers $1 \leq i \leq l$. We therefore know that

$$\sum_{v \in N_G(u)} L_{x_0}(u^v) = 0, \quad u \in V(\vec{G}).$$

Thus, $\vec{G}^{L_{u(\mathbf{x})}} \in \vec{G}^\mathcal{V}$. This completes the proof. □

There are many interesting conclusions on \vec{G} -flow solutions of equations by Theorem 4.8. For example, if \mathcal{F}_i is nothing else but polynomials of degree n in one variable x , we get a conclusion following, which generalizes the fundamental theorem in algebra.

Corollary 4.9.(Generalized Fundamental Theorem in Algebra) If \vec{G} is strong-connected with circuit decomposition

$$\vec{G} = \bigcup_{i=1}^l \vec{C}_i$$

and $L_i(u^v) = a_i \in \mathbb{C}$ for $\forall(u, v) \in X(\vec{C}_i)$ and integers $1 \leq i \leq l$, then the polynomial

$$F(X) = \vec{G}^{L_1} \circ X^n + \vec{G}^{L_2} \circ X^{n-1} + \dots + \vec{G}^{L_n} \circ X + \vec{G}^{L_{n+1}}$$

always has roots, i.e., $X_0 \in \vec{G}^\mathbb{C}$ such that $F(X_0) = \mathbf{0}$ if $\vec{G}^{L_1} \neq \mathbf{0}$ and $n \geq 1$.

Particularly, an algebraic equation

$$a_1x^n + a_2x^{n-1} + \dots + a_nx + a_{n+1} = 0$$

with $a_1 \neq 0$ has infinite many \vec{G} -flow solutions in $\vec{G}^\mathbb{C}$ on those topological graphs \vec{G} with $\vec{G} = \bigcup_{i=1}^l \vec{C}_i$.

Notice that Theorem 4.8 enables one to get \vec{G} -flow solutions both on those linear and non-linear equations in physics. For example, we know the spherical solution

$$ds^2 = f(t) \left(1 - \frac{rg}{r} \right) dt^2 - \frac{1}{1 - \frac{rg}{r}} dr^2 - r^2(d\theta^2 + \sin^2 \theta d\phi^2)$$

for the Einstein's gravitational equations ([9])

$$R^{\mu\nu} - \frac{1}{2}Rg^{\mu\nu} = -8\pi GT^{\mu\nu}$$

with $R^{\mu\nu} = R_{\alpha\beta}^{\mu\alpha\nu} = g_{\alpha\beta}R^{\alpha\mu\beta\nu}$, $R = g_{\mu\nu}R^{\mu\nu}$, $G = 6.673 \times 10^{-8} \text{cm}^3/\text{gs}^2$, $\kappa = 8\pi G/c^4 = 2.08 \times 10^{-48} \text{cm}^{-1} \cdot \text{g}^{-1} \cdot \text{s}^2$. By Theorem 4.8, we get their \vec{G} -flow solutions following.

Corollary 4.10. The Einstein’s gravitational equations

$$R^{\mu\nu} - \frac{1}{2}Rg^{\mu\nu} = -8\pi GT^{\mu\nu},$$

has infinite many \vec{G} -flow solutions in \vec{G}^c , particularly on those topological graphs $\vec{G} = \bigcup_{i=1}^l \vec{C}_i$ with spherical solutions of the equations on their arcs.

For example, let $\vec{G} = \vec{C}_4$. We are easily find \vec{C}_4 -flow solution of Einstein’s gravitational equations,such as those shown in Fig.7.

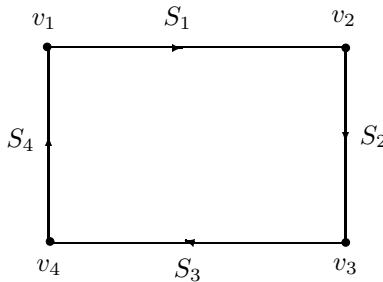

Fig.7

where, each S_i is a spherical solution

$$ds^2 = f(t) \left(1 - \frac{r_s}{r}\right) dt^2 - \frac{1}{1 - \frac{r_s}{r}} dr^2 - r^2(d\theta^2 + \sin^2 \theta d\phi^2)$$

of Einstein’s gravitational equations for integers $1 \leq i \leq 4$.

As a by-product, Theorems 4.5-4.6 can be also generalized on those topological graphs with circuit-decomposition following.

Corollary 4.11. Let the integral kernel $K(\mathbf{x}, \mathbf{y}) : \Delta \times \Delta \rightarrow \mathbb{C} \in L^2(\Delta \times \Delta)$ be given with

$$\int_{\Delta \times \Delta} |K(\mathbf{x}, \mathbf{y})|^2 dx dy > 0, \quad \overline{K(\mathbf{x}, \mathbf{y})} = K(\mathbf{x}, \mathbf{y})$$

for almost all $(\mathbf{x}, \mathbf{y}) \in \Delta \times \Delta$, and

$$\vec{G}^L = \bigcup_{i=1}^l \vec{C}_i$$

such that $L(u^v) = L_{[i]}(\mathbf{x})$ for $\forall(u, v) \in X(\vec{C}_i)$ and integers $1 \leq i \leq l$. Then, the integral equation

$$\vec{G}^X - \int_{\Delta} \vec{G}^X = G^L$$

is solvable in $\vec{G}^{\mathcal{Y}}$ with $\mathcal{Y} = L^2[\Delta]$ if and only if

$$\langle \vec{G}^L, \vec{G}^{L'} \rangle = 0, \quad \forall \vec{G}^{L'} \in \mathcal{N}^*.$$

Corollary 4.12. Let the integral kernel $K(\mathbf{x}, \mathbf{y}) : \Delta \times \Delta \rightarrow \mathbb{C} \in L^2(\Delta \times \Delta)$ be given with

$$\int_{\Delta \times \Delta} |K(\mathbf{x}, \mathbf{y})|^2 d\mathbf{x}d\mathbf{y} > 0, \quad \overline{K(\mathbf{x}, \mathbf{y})} = K(\mathbf{x}, \mathbf{y})$$

for almost all $(\mathbf{x}, \mathbf{y}) \in \Delta \times \Delta$, and

$$\vec{G}^L = \bigcup_{i=1}^l \vec{C}_i$$

such that $L(u^v) = L_{[i]}(\mathbf{x})$ for $\forall(u, v) \in X(\vec{C}_i)$ and integers $1 \leq i \leq l$. Then, there is a finite or countably infinite system \vec{G} -flows $\{\vec{G}^{L_i}\}_{i=1,2,\dots} \subset L^2(\Delta, \mathbb{C})$ with associate real numbers $\{\lambda_i\}_{i=1,2,\dots} \subset \mathbb{R}$ such that the integral equations

$$\int_{\Delta} K(\mathbf{x}, \mathbf{y}) \vec{G}^{L_i[\mathbf{y}]} d\mathbf{y} = \lambda_i \vec{G}^{L_i[\mathbf{x}]}$$

hold with integers $i = 1, 2, \dots$, and furthermore,

$$|\lambda_1| \geq |\lambda_2| \geq \dots \geq 0 \quad \text{and} \quad \lim_{i \rightarrow \infty} \lambda_i = 0.$$

5. APPLICATIONS TO SYSTEM CONTROL

5.1 Stability of \vec{G} -Flow Solutions

Let $X = \vec{G}^{L_{u(\mathbf{x})}}$ and $X_2 = \vec{G}^{L_{u_1(\mathbf{x})}}$ be respectively solutions of

$$\mathcal{F}(\mathbf{x}, X_{x_1}, \dots, X_{x_n}, X_{x_1 x_2}, \dots) = 0$$

on the initial values $X|_{\mathbf{x}_0} = \vec{G}^L$ or $X|_{\mathbf{x}_0} = \vec{G}^{L_1}$ in $\vec{G}^{\mathcal{V}}$ with $\mathcal{V} = L^2[\Delta]$, the Hilbert space. The \vec{G} -flow solution X is said to be *stable* if there exists a number $\delta(\varepsilon)$ for any number $\varepsilon > 0$ such that

$$\|X_1 - X_2\| = \left\| \vec{G}^{L_{u_1(\mathbf{x})}} - \vec{G}^{L_{u(\mathbf{x})}} \right\| < \varepsilon$$

if $\left\| \vec{G}^{L_1} - \vec{G}^L \right\| \leq \delta(\varepsilon)$. By definition,

$$\left\| \vec{G}^{L_1} - \vec{G}^L \right\| = \sum_{(u,v) \in X(\vec{G})} \|L_1(u^v) - L(u^v)\|$$

and

$$\left\| \vec{G}^{L_{u_1(\mathbf{x})}} - \vec{G}^{L_{u(\mathbf{x})}} \right\| = \sum_{(u,v) \in X(\vec{G})} \|u_1(u^v)(\mathbf{x}) - u(u^v)(\mathbf{x})\|.$$

Clearly, if these \vec{G} -flow solutions X are stable, then

$$\|u_1(u^v)(\mathbf{x}) - u(u^v)(\mathbf{x})\| \leq \sum_{(u,v) \in X(\vec{G})} \|u_1(u^v)(\mathbf{x}) - u(u^v)(\mathbf{x})\| < \varepsilon$$

if

$$\|L_1(u^v) - L(u^v)\| \leq \sum_{(u,v) \in X(\vec{G})} \|L_1(u^v) - L(u^v)\| \leq \delta(\varepsilon),$$

i.e., $u(u^v)(\mathbf{x})$ is stable on u^v for $(u, v) \in X(\vec{G})$.

Conversely, if $u(u^v)(\mathbf{x})$ is stable on u^v for $(u, v) \in X(\vec{G})$, i.e., for any number $\varepsilon/\varepsilon(\vec{G}) > 0$ there always is a number $\delta(\varepsilon)(u^v)$ such that

$$\|u_1(u^v)(\mathbf{x}) - u(u^v)(\mathbf{x})\| < \frac{\varepsilon}{\varepsilon(\vec{G})}$$

if $\|L_1(u^v) - L(u^v)\| \leq \delta(\varepsilon)(u^v)$, then there must be

$$\sum_{(u,v) \in X(\vec{G})} \|u_1(u^v)(\mathbf{x}) - u(u^v)(\mathbf{x})\| < \varepsilon(\vec{G}) \times \frac{\varepsilon}{\varepsilon(\vec{G})} = \varepsilon$$

if

$$\|L_1(u^v) - L(u^v)\| \leq \frac{\delta(\varepsilon)}{\varepsilon(\vec{G})},$$

where $\varepsilon(\vec{G})$ is the number of arcs of \vec{G} and

$$\delta(\varepsilon) = \min \left\{ \delta(\varepsilon)(u^v) \mid (u, v) \in X(\vec{G}) \right\}.$$

Whence, we get the result following.

Theorem 5.1. Let \mathcal{V} be the Hilbert space $L^2[\Delta]$. The \vec{G} -flow solution X of equation

$$\begin{cases} \mathcal{F}(\mathbf{x}, X, X_{x_1}, \dots, X_{x_n}, X_{x_1x_2}, \dots) = 0 \\ X|_{\mathbf{x}_0} = \vec{G}^L \end{cases}$$

in $\vec{G}^{\mathcal{V}}$ is stable if and only if the solution $u(\mathbf{x})(u^v)$ of equation

$$\begin{cases} \mathcal{F}(\mathbf{x}, u, u_{x_1}, \dots, u_{x_n}, u_{x_1x_2}, \dots) = 0 \\ u|_{\mathbf{x}_0} = \vec{G}^L \end{cases}$$

is stable on the semi-arc u^v for $\forall (u, v) \in X(\vec{G})$.

This conclusion enables one to find stable \vec{G} -flow solutions of equations. For example, we know that the stability of trivial solution $\mathbf{y} = \mathbf{0}$ of an ordinary differential equation

$$\frac{d\mathbf{y}}{d\mathbf{x}} = [A]\mathbf{y}$$

with constant coefficients, is dependent on the number $\gamma = \max\{\operatorname{Re}\lambda : \lambda \in \sigma[A]\}$ ([23]), i.e., it is stable if and only if $\gamma < 0$, or $\gamma = 0$ but $m'(\lambda) = m(\lambda)$ for all eigenvalues λ with $\operatorname{Re}\lambda = 0$, where $\sigma[A]$ is the set of eigenvalue of the matrix $[A]$, $m(\lambda)$ the multiplicity and $m'(\lambda)$ the dimension of corresponding eigenspace of λ .

Corollary 5.2. Let $[A]$ be a matrix with all eigenvalues $\lambda < 0$, or $\gamma = 0$ but $m'(\lambda) = m(\lambda)$ for all eigenvalues λ with $\operatorname{Re}\lambda = 0$. Then the solution $X = \mathbf{0}$ of differential equation

$$\frac{dX}{d\mathbf{x}} = [A]X$$

is stable in $\vec{G}^{\mathcal{V}}$, where \vec{G} is such a topological graph that there are \vec{G} -flows hold with the equation.

For example, the \vec{G} -flow shown in Fig.8 following

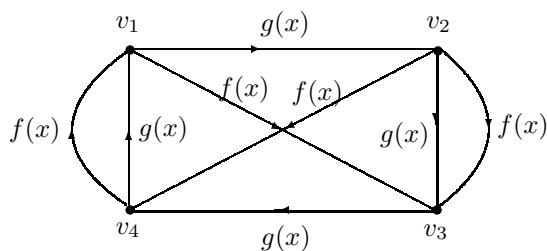

Fig.8

is a \vec{G} -flow solution of the differential equation

$$\frac{d^2 X}{dx^2} + 5 \frac{dX}{dx} + 6X = 0$$

with $f(x) = C_1 e^{-2x} + C'_1 e^{-3x}$ and $g(x) = C_2 e^{-2x} + C'_2 e^{-3x}$, where C_1, C'_1 and C_2, C'_2 are constants.

Similarly, applying the stability of solutions of wave equations, heat equations and elliptic equations, the conclusion following is known by Theorem 5.1.

Corollary 5.3. Let \mathcal{V} be the Hilbert space $L^2[\Delta]$. Then, the \vec{G} -flow solutions X of equations following

$$\left\{ \begin{array}{l} \frac{\partial^2 X}{\partial t^2} - c^2 \left(\frac{\partial^2 X}{\partial x_1^2} + \frac{\partial^2 X}{\partial x_2^2} \right) = \vec{G}^L \\ X|_{t_0} = \vec{G}^{L_{\phi(x_1, x_2)}}, \quad \frac{\partial X}{\partial t} \Big|_{t_0} = \vec{G}^{L_{\varphi(x_1, x_2)}}, \quad X|_{\partial \Delta} = \vec{G}^{L_{\mu(t, x_1, x_2)}} \end{array} \right\},$$

$$\left\{ \begin{array}{l} \frac{\partial^2 X}{\partial t^2} - c^2 \frac{\partial X}{\partial x_1} = \vec{G}^L \\ X|_{t_0} = \vec{G}^{L_{\phi(x_1, x_2)}} \end{array} \right\} \quad \text{and} \quad \left\{ \begin{array}{l} \frac{\partial^2 X}{\partial x_1^2} + \frac{\partial^2 X}{\partial x_2^2} + \frac{\partial^2 X}{\partial x_3^2} = \mathbf{0} \\ X|_{\partial \Delta} = \vec{G}^{L_{g(x_1, x_2, x_3)}} \end{array} \right\}$$

are stable in $\vec{G}^{\mathcal{V}}$, where \vec{G} is such a topological graph that there are \vec{G} -flows hold with these equations.

5.2 Industrial System Control

An industrial system with raw materials M_1, M_2, \dots, M_n , products (including by-products) P_1, P_2, \dots, P_m but w_1, w_2, \dots, w_s wastes after a produce process, such as those shown in Fig.9 following,

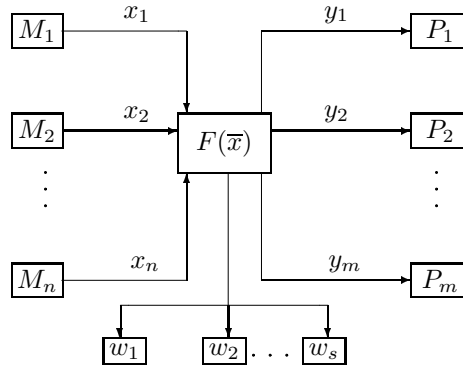

Fig.9

i.e., an input-output system, where,

$$(y_1, y_2, \dots, y_m) = F(x_1, x_2, \dots, x_n)$$

determined by differential equations, called the *production function* and constrained with the conservation law of matter, i.e.,

$$\sum_{i=1}^m y_i + \sum_{i=1}^s w_i = \sum_{i=1}^n x_i.$$

Notice that such an industrial system is an opened system in general, which can be transferred into a closed one by letting the nature as an additional cell, i.e., all materials comes from and all wastes resolves by the nature, a classical one on human beings with the nature. However, the resolvability of nature is very limited. Such a classical system finally resulted in the environmental pollution accompanied with the developed production of human beings.

Different from those of classical industrial systems, an *ecologically industrial system* is a recycling system ([24]), i.e., all outputs of one of its subsystem, including products, by-products provide the inputs of other subsystems and all wastes are disposed harmless to the nature. Clearly, such a system is nothing else but a \vec{G} -flow because it is holding with conservation laws on each vertex in a topological graph \vec{G} , where \vec{G} is determined by the technological process for products, wastes disposal and recycle, and can be characterized by differential equations in Banach space $\vec{G}^\mathcal{V}$. Whence, we can determine such a system by \vec{G}^{L_u} with $L_u : u^v \rightarrow u(u^v)(t, \mathbf{x})$ for $(u, v) \in X(\vec{G})$, or ordinary differential equations

$$\begin{cases} \vec{G}^{L_0} \circ \frac{d^k X}{dt^k} + \vec{G}^{L_1} \circ \frac{d^{k-1} X}{dt^{k-1}} + \dots + \vec{G}^{L_{u(t, \mathbf{x})}} = \mathbf{0} \\ X|_{t=t_0} = \vec{G}^{L_{h_0(\mathbf{x})}}, \frac{dX}{dt} \Big|_{t=t_0} = \vec{G}^{L_{h_1(\mathbf{x})}}, \dots, \frac{dX^{k-1}}{dt^{k-1}} \Big|_{t=t_0} = \vec{G}^{L_{h_{k-1}(\mathbf{x})}} \end{cases}$$

for an integer $k \geq 1$, or a partial differential equation

$$\begin{cases} \vec{G}^{L_0} \circ \frac{\partial X}{\partial t} + \vec{G}^{L_1} \circ \frac{\partial X}{\partial x_1} + \dots + \vec{G}^{L_n} \circ \frac{\partial X}{\partial x_n} = \vec{G}^{L_{u(t, \mathbf{x})}} \\ X|_{t=t_0} = \vec{G}^{L_{u(\mathbf{x})}} \end{cases}$$

and characterize its stability by Theorem 5.1, where, the coefficients $\vec{G}^{L_i}, i \geq 0$ are determined by the technological process of production.

REFERENCES

- [1] John B.Conway, *A Course in Functional Analysis*, Springer-Verlag New York,Inc., 1990.
- [2] J.L.Gross and T.W.Tucker, *Topological Graph Theory*, John Wiley & Sons, 1987.
- [3] F.John, *Partial Differential Equations* (4th edition), Springer-Verlag New York,Inc., 1982.
- [4] Kenneth Hoffman and Ray Kunze, *Linear Algebra*(Second Edition), Prentice-Hall, Inc. Englewood Cliffs, New Jersey, 1971.
- [5] Linfan Mao, The simple flow representation for graph and its application, Reported at *The First International Symposium on Combinatorial Optimization of China*, Tianjing, 1988.
- [6] Linfan Mao, Analytic graph and its applications, Reported at *The 6th Conference on Graph Theory and Its Applications of China*, Qingdao, 1989.
- [7] Linfan Mao, *Automorphism Groups of Maps, Surfaces and Smarandache Geometries*, First edition published by American Research Press in 2005, Second edition is as a Graduate Textbook in Mathematics, Published by The Education Publisher Inc., USA, 2011.
- [8] Linfan Mao, *Smarandache Multi-Space Theory*(Second edition), First edition published by Hexis, Phoenix in 2006, Second edition is as a Graduate Textbook in Mathematics, Published by The Education Publisher Inc., USA, 2011.
- [9] Linfan Mao, *Combinatorial Geometry with Applications to Field Theory*, First edition published by InfoQuest in 2009, Second edition is as a Graduate Textbook in Mathematics, Published by The Education Publisher Inc., USA, 2011.
- [10] Linfan Mao, Non-solvable spaces of linear equation systems. *International J. Math. Combin.*, Vol.2 (2012), 9-23.
- [11] Linfan Mao, Graph structure of manifolds listing, *International J.Contemp. Math. Sciences*, Vol.5, 2011, No.2,71-85.
- [12] Linfan Mao, A generalization of Seifert-Van Kampen theorem for fundamental groups, *Far East Journal of Math.Sciences*, Vol.61 No.2 (2012), 141-160.
- [13] Linfan Mao, Global stability of non-solvable ordinary differential equations with applications, *International J.Math. Combin.*, Vol.1 (2013), 1-37.
- [14] Linfan Mao, Non-solvable equation systems with graphs embedded in \mathbf{R}^n , *International J.Math. Combin.*, Vol.2 (2013), 8-23.
- [15] Linfan Mao, Geometry on G^L -system of homogenous polynomials, *International J.Contemp. Math. Sciences* (Accepted, 2014).
- [16] Linfan Mao, A topological model for ecologically industrial systems, *International J.Math. Combin.*, Vol.1(2014), 109-117.
- [17] Linfan Mao, Cauchy problem on non-solvable system of first order partial differential equations with applications, *Methods and Applications of Analysis* (Accepted).
- [18] Linfan Mao, Mathematics on non-mathematics – a combinatorial contribution, *International J.Math.Combin.*, Vol.3, 2014, 1-34.
- [19] Linfan Mao, Geometry on non-solvable equations – A review on contradictory systems, Reported at the *International Conference on Geometry and Its Applications*, Jardpour University, October 16-18, 2014, Kolkata, India, Also appeared in *International J.Math.Combin.*, Vol.4, 2014, 18-38.
- [20] F.Sauvigny, *Partial Differential Equations* (Vol.1 and 2), Springer-Verlag Berlin Heidelberg, 2006.
- [21] F.Smarandache, *Paradoxist Geometry*, State Archives from Valcea, Rm. Valcea, Romania, 1969, and in *Paradoxist Mathematics*, Collected Papers (Vol. II), Kishinev University Press, Kishinev, 5-28, 1997.
- [22] F.Smarandache, Multi-space and multi-structure, in *Neutrosophy. Neutrosophic Logic, Set, Probability and Statistics*, American Research Press, 1998.
- [23] Wolfgang Walter, *Ordinary Differential Equations*, Springer-Verlag New York,Inc., 1998.
- [24] Zengjun Yuan and Jun Bi, *Industrial Ecology* (in Chinese), Science Press, Beijing, 2010.

LINFAN MAO

CHINESE ACADEMY OF MATHEMATICS AND SYSTEM SCIENCE, BEIJING 100190, P.R.CHIN

E-mail address: maolinfan@163.com