

SMARANDACHE NOTIONS JOURNAL

n	#1	#2	#3	#4	#5	#6	#7	#8	#9	#10	#11
	13	210	47760	48594	60943	103305	163823	252061	349033	3280590	5364719
S(n)	13	7	199	89	60943	97	281	173	8513	36451	5364719
S(n+1)	7	211	6823	9719	293	157	3413	126031	233	3280591	7451
S(n+2)	5	53	167	12149	239	103307	6553	4001	23269	1723	114143
S(n+3)	6	71	61	167	983	8609	6301	7877	1229	1093531	243851
S(n+4)	17	107	11941	94	1033	103	167	4583	26849	30949	457
S(n+5)	6	43	233	2113	1693	10331	5851	977	19391	656119	78893
S(n+6)	19	9	419	12	8707	883	419	569	349039	857	214589
Sum	73	501	19843	24343	73891	123487	22985	144211	428523	5100221	6024103
S(n+7)	5	31	1291	131	53	587	127	53	4363	172663	47059
S(n+8)	7	109	853	1279	1847	14759	947	1151	1511	1640299	5689
S(n+9)	11	73	15923	953	401	257	20479	277	2861	173	4441
S(n+10)	23	11	281	419	60953	20663	563	3037	349043	349	596081
S(n+11)	4	17	67	9721	10159	1123	677	389	59	5827	443
S(n+12)	10	37	1327	8101	167	34439	151	13267	69809	307	5364731
S(n+13)	13	223	101	3739	311	51659	41	126037	877	3280603	5659
Sum	73	501	19843	24343	73891	123487	22985	144211	428523	5100221	6024103

TRANSILVANIA UNIVERSITY OF BRAȘOV

The scheme on the first cover represents the Smarandache function 7-7 additive relationships and belongs to H. Ibstedt (see p. 73).

This journal is an extension of the "Smarandache Function Journal", ISBN 1053-4792, Vol. 1-6, 1990-1995.

SNJ is yearly published (in the Spring or Fall) in a 300-400 pages volume, and 800-1000 copies.

SNJ is a referred journal: reviewed, indexed, cited by the following journals: "Zentralblatt Für Mathematik" (Germany), "Referativnyi Zhurnal" and "Matematika" (Academia Nauk, Russia), "Mathematical Reviews" (USA), "Computing Review" (USA), "Libertas Mathematica" (USA), "Octogon" (Romania), "Indian Science Abstracts" (India), "Ulrich's International Periodicals Directory" (USA), "Gale Directory of Publications and Broadcast Media" (USA), "Historia Mathematica" (USA), "Journal of Recreational Mathematics" (USA), "The Mathematical Gazette" (U.K.), "Abstracts of Papers Presented to the American Mathematical Society" (USA), "Personal Computer World" (U.K.), "Mathematical Spectrum" (U.K.), "Bulletin of Pure and Applied Sciences" (India), Institute for Scientific Information (PA, USA), "Library of Congress Subject Headings" (USA).

Referents:

Murad A. Aldamen, P. O. Box 713330, Hai Nazzal 11171, Amman, Jordan.

Y. V. Chebrakov, Department of Mathematics, St.-Petersburg Technical University, Nevsky 3-11, 191186, Russia.

Ion Goian, Department of Algebra, Number Theory and Logic, State University of Kishinev, Republic of Moldova.

Florian Luca, Instituto de Matematicas UNAM, Campus Morelia, Apartado Postal 61-3 (Xangari), CP 58 089, Morelia, Michoacan, México.

Chris Nash, 5000 Bryan Station Road #5, Lexington, KY 40516-9505, USA.

Carlos B. Rivera F., J. Pardavé 517, Col Lomas del Roble, San Nicolás de los Garza, CP 66450, Nuevo León, México.

Sebastian Martin Ruiz, Avda. De Regla, 43, Chipiona 11550, Cadiz, Spain.

Copyright 2001

by Transilvania University of Braşov, Department of Mathematics and Computer Science, Braşov, Romania.

ASSOCIATE EDITORIAL BOARD:

Charles Ashbacher, Charles Ashbacher Technologies, Box 294, 119 Northwood Drive, Hiawatha, Iowa 52233, USA.

Ion Balacenoiu, Department of Mathematics, University of Craiova, Romania.

Mihaly Bencze, Str. Hărmanului 6, 2212 Săcele 3, Jud. Braşov,

Romania.

Emil Burton, Department of Mathematics, University of Cluj-Napoca, Romania.

Ion Cojocaru & Sorin Cojocaru, Department of Mathematics, University of Craiova, Romania.

Constantin Corduneanu, Department of Mathematics, University of Texas at Arlington, USA.

Henry Ibstedt, Glimminge 2036, 280 60 Broby, Sweden.

Widmer Lamarr, Department of Mathematics, Mesiah College, Grantham, PA 17027, USA.

Maohua Le, Department of Mathematics, Zhanjiang Normal College, 29 Cunjin Road, Chikan, Zhanjiang, Guangdong, P.R.China.

A.A.K. Majumdar, Department of Mathematics, Jahangirnagar University, Savar, Dhaka 1342, Bangladesh.

Leonardo Fernandes Dias da Motta, Av. Conselheiro Furtado, 1574, Apt. 501, Bairro Batista Campos, Belem, PA 66040-100, Brazil.

Mike Mudge, 22 Gors Fach, Pwll-Trap, St Clears, Carmarthenshire, Dyfed SA33 4AQ, United Kingdom.

Jean Normand, 3, square Robinson, 92330 Sceaux, France.

E. Rădescu & N. Rădescu, Department of Mathematics, University of Craiova, Romania.

Francisco Bellot Rosado, Dos de Mayo 16-8^o dcha, E-47004 Valladolid, Spain.

Felice Russo, Micron Technology Italy, Avezzano (Aq), Italy.

Jozsef Sandor, Department of Mathematics, Babeş-Bolyai University, 3400 Cluj-Napoca, Romania.

Vasile Seleacu, Department of Mathematics, University of Craiova, Romania.

Y. A. Shmagin, Department of Mathematics, St.-Petersburg Technical University, Nevsky 3-11, 191186, St.-Petersburg, Russia.

Vera W. de Spinadel, Centro de Matematica y Diseno MAYDI, Facultad de Arquitectura, Diseno y Urbanismo, Universidad de Buenos Aires, Argentina.

INDICATION TO AUTHORS

Authors of papers concerning any of Smarandache type functions, numbers, sequences, integer algorithms, paradoxes, Non-Euclidean geometries, etc. are encouraged to submit manuscripts to the Editors:

Prof. Sabin & Tatiana Tabirca

Department of Mathematics

Transilvania University of Brasov, Romania.

The submitted manuscripts may be in the format of remarks,

conjectures, solved/unsolved or open new proposed problems, notes, articles, miscellaneous, etc. They must be original work and camera ready [typewritten/computerized, format: 8.5 x 11 inches (\approx 21,6 x 28 cm)]. They are not returned, hence we advise the authors to keep a copy.

The title of the paper should be writing with capital letters. The author's name has to apply in the middle of the line, near the title. References should be mentioned in the text by a number in square brackets and should be listed alphabetically. Current address followed by e-mail address should apply at the end of the paper, after the references.

The paper should have at the beginning an up to a half-page abstract, followed by the key words.

All manuscripts are subject to anonymous review by two or more independent sources.

Every letter will be answered.

The authors will receive free copies of the journal.

Papers in electronic form are accepted. They can be e-mailed in Microsoft Word 97 (or lower), WordPerfect 7.0 (or lower), PDF 4.0, or ASCII files.

A model for Smarandache's Anti-Geometry

ROBERTO TORRETTI

Universidad de Chile
Casilla 20017 – Correo 20
Santiago, Chile
<cordua@rdc.cl>

David Hilbert's *Foundations of Geometry* (1899) contain nineteen statements, labelled *axioms*, from which every theorem in Euclid's *Elements* can be derived by deductive inference, according to the classical rules of logic. The axioms use three property words —‘point’, ‘straight’ and ‘plane’— and three relation words —‘incident’, ‘between’ and ‘congruent’— for which no definition is given. These words have, of course, a so-called intuitive meaning in English (as the German equivalents actually used by Hilbert have in his language). But Hilbert believed they ought to be understood in whatever sense was compatible with the constraints prescribed by the axioms themselves.¹ To show that some of his axioms were not logical consequences of the others he unhesitatingly bestowed unorthodox meanings on the undefined terms. This enabled him to produce models that satisfied all the axioms but one, plus the negation of the excluded axiom.

The mathematician-philosopher Gottlob Frege showed little understanding for Hilbert's procedure. Frege thought that the undefined terms stood for properties and relations that Hilbert assumed to be well-known and that the axioms were intended as true statements about them. Hilbert disabused him: “I do not wish to presuppose anything as known; I see in my declaration in §1 the definition of the

¹ Although these constraints are very restrictive, the nineteen axioms admit two non-isomorphic models, viz., (i) the uncountable three-dimensional continuum that underlies Cartesian geometry and Newtonian analysis, and (ii) the countable set of points constructible with ruler and compasses from which Euclid built his figures. To suppress this ambiguity, Hilbert added the Axiom of Completeness (V.2) in Laugel's French translation (1900b); it subsequently was included in all German editions, beginning with the second (1903). With this addition, Hilbert's axiom system only admits isomorphic models.

concepts ‘points’, ‘straights’, ‘planes’, provided that one adds all the axioms in axiom groups I–V as expressing the defining characters” (Hilbert to Frege, 29.12.1899, in Frege 1967, p. 411). Frege had complained that Hilbert’s concepts were equivocal, the predicate ‘between’ being applied to genuine geometrical points in §1 and to real number pairs in §9. Hilbert replied:

Of course every theory is only a scaffolding or schema of concepts together with their necessary mutual relations, and the basic elements can be conceived in any way you wish. If I take for my points any system of things, for example, the system love, law, chimney-sweep, . . . and I just assume all my axioms as relations between these things, my theorems—for example, Pythagoras’s—also hold of these things. In other words: every theory can always be applied to infinitely many systems of basic elements. One needs only to apply an invertible one–one transformation and to stipulate that the axioms for the transformed things are respectively the same. [. . .] This feature of theories can never be a shortcoming and is in any case inevitable.

(Hilbert to Frege, 29.12.1899; in Frege 1967, pp. 412–13)

Hilbert’s reply has continued to sound artificial to those unwilling or unable to follow him in his leap to abstraction, because it is not possible to find a set of familiar relations among chimney-sweeps, laws and states of being in love which, when equated with Hilbert’s relations of incidence, betweenness and congruence, would make his axioms to be true. But Hilbert’s point can now be made crystal-clear thanks to Florian Smarandache’s *Anti-Geometry*.²

Anti-Geometry rests on a system of nineteen axioms, each one of which is the negation of one of Hilbert’s nineteen axioms.³ Such wholesale negation brings

2 My knowledge of this system is based on Sandy P. Chimienti and Mihaly Bencze’s paper “Smarandache Anti-Geometry”, as published in the Worldwide Web (<http://www.gallup.unm.edu/~smarandache/prd-geo4.txt>). I reproduce Smarandache’s axioms from this paper, with mild stylistic corrections.

3 In the paper mentioned in ref. 2, Chimienti and Bencze say that “all Hilbert’s 20 axioms of the Euclidean Geometry are denied in this vanguardist geometry”. However, only the 19 axioms of 1899 are denied explicitly. Indeed, negation of Axiom V.2 is implicit, insofar as Smarandache’s axioms of anti-geometry admit non-isomorphic models. For instance, if you change the date of the model proposed below from 31 December 1999 to 31 December 1899 you obtain at once a second model which is not isomorphic with mine (the total number of bank accounts in the United States was surely much less in 1899 than in 1999).

about a complete collapse of the constraints imposed by Hilbert's axioms on its conceivable models. The immediate consequence of this is that models of Anti-Geometry can be readily found in all walks of life.⁴ On the other hand, and for the same reason, the truths concerning these models that can be obtained from Smarandache's axioms by deductive inference are somewhat uninteresting, to say the least.

I shall now state my interpretation of the undefined terms in Smarandache's (and Hilbert's) axioms and show, thereupon, that Smarandache's nineteen axioms come out true under this interpretation. Following Chimienti and Bencze (ref. 2), I say 'line' where Hilbert says 'straight' (*gerade*).⁵ Points lying on one and the same line are said to be *collinear*; points or lines lying on one and the same plane are said to be *coplanar*. Two lines are said to *meet* or *intersect* each other if they have a point in common.

In my interpretation the geometrical terms employed in the axioms are made to stand for ordinary, non-geometric objects and relations, with which I assume the reader is familiar. As a matter of fact, Smarandache's system, despite its vaunted vanguardistic libertarianism, still imposes a few existential constraints on admissible models; for example, his Axiom III presupposes the existence of infinitely many of the objects called 'lines'. This has forced me to introduce three existence postulates which my model is required to comply with, at least one of which is plainly unnatural (EP3).



I list below the meaning I bestow on Hilbert's property words:

(i) A *point* is the balance in a particular checking account, expressed in U.S. currency. (Points will be denoted by capital letters).

You can also extend the domain of my model, in direct contradiction with Hilbert's Axiom V.2, by adding all Swiss banks to the U.S. banks comprised in the extension of 'plane'.

⁴ I lighted on the model I shall present below while recovering from a long, delicious and calory-rich lunch with a poet, a psychiatrist and a philosopher, during which not a single word was said about geometry and I drank half a bottle of excellent Chilean merlot.

⁵ Was this deviant usage adopted because "some of our lines are curves", as Chimienti and Bencze note in their definition of 'angle' (following their Axiom IV.3)? That would bespeak a deep misunderstanding of Hilbertian axiomatics. I hope that my interpretation will make this clear. In it, *lines* are persons, and we might just as well have called them *straights*.

NOTE. Two points A and B may be distinct, because they are balances from different accounts, which may or may not belong to different persons, and yet be equal in amount, in which case we shall say that A *equals* B (symbolized $A = B$). If A and B are the same point, we say that A and B *are identical*. Of course, in current mathematical parlance "equal", signified by "=", means "identical", but, like Humpty Dumpty and David Hilbert, I feel free to use words any way I wish, provided that I explain their meaning clearly. I use the standard symbol $<$ to express that a given balance is smaller than another.

(ii) A *line* is a person, who can be a human being or an angel. (Lines are denoted by lower case italics).

(iii) A *plane* is a U.S. bank, affiliated to the FDIC. (Planes are denoted by lower case Greek letters).

Here are the meanings I bestow on the relation words. All relations are supposed to hold at midnight E.S.T. of December 31, 1999.

1. Point A *lies on* line a if and only if person a owns the particular account that shows balance A. (For brevity's sake, I shall often say that a owns balance A when he or she owns the said account.)

2. Line a *lies on* plane α if and only if the person a has a checking account with bank α .

3. Point A *lies on* plane α if and only if the particular checking account that shows balance A is held with bank α .

4. Point B is *between* points A and C, if and only if balances A, B and C are the balances in three different accounts belonging to the same person x , and $A = B < C$.

Items 1–4 take care of *betweenness* and the three kinds of *incidence* we find in Hilbert and Smarandache. Hilbert's relation of *congruence* does not apply, however, to points, lines or planes, but to two sorts of figures constructed from points and lines, viz. *segments* and *angles*. I must therefore define these figures in terms of *my* points and lines.

DEF. I. If two balances A and B belong to the same person x , the collection formed by A, B and all balances Y belonging to x and such that A is less than Y and Y is less than B is called *the segment* AB.

NOTE. By our definition of “betweenness”, the points belonging to segment AB but not identical with A or B do not lie between A and B. However, the Smarandache axioms are stated in such a way that none of them contradicts this surprising theorem.

DEF. II. If a balance O is owned in common by persons h and k , the set formed by h , k and O is called *the angle* (h, O, k) (symbolized $\angle hOk$).

NOTE 1. h and k could be the same person, in which case the qualification “in common” is trivial.

NOTE 2. If h and k are distinct persons, such that h besides O owns a balance P, not shared with k , and k , besides O, owns a balance Q, not shared with h , $\angle hOk$ may be called “the angle POQ” and be symbolized by $\angle POQ$. In other words, the expression “ $\angle POQ$ ” has a referent if and only if there exist persons h and k who respectively own balance P and balance Q separately from one another, and share the balance O; otherwise, this expression has no referent.

DEF. III. Person a *acquired* balance A *partly from* person b if and only if a part of balance A was electronically transferred from funds owned by b to the account owned by a which shows balance A. Instead of “ a acquired A partly from b ” we write $\star(a, A, b)$

I am now in a position to define Hilbert’s two sorts of *congruence*.

5. Segment AB is congruent with segment CD if and only if there is a person x such that $\star(h, A, x)$ and $\star(h, B, x)$ and $\star(k, C, x)$ and $\star(k, D, x)$, where h denotes the owner of balances A and B, and k denotes the owner of balances C and D.

6. Angle (h, P, k) is congruent with angle (f, Q, g) if there is a person x such that $\star(h, P, x)$ and $\star(k, P, x)$ and $\star(f, Q, x)$ and $\star(g, Q, x)$.

We shall also need the following definitions:

DEF. IV. Two distinct lines a and b are said to be *parallel* if and only if persons a and b have accounts with the same bank α but do not own any balance in common.

DEF. V. Let A be a balance belonging to a person h . Any other balances owned by h can be divided into three classes: (i) those that are less than A, (ii) those that are greater than A, and (iii) those that are equal to A. Balances of class (i) and (ii) which are held by h in other accounts with the same bank where he has A will be said to lie, respectively, *on one* and *on the other side of* A (on h).

As I said, the fairly weak but nevertheless inescapable constraints implicit in some of Smarandache's axioms force me to adopt three existence postulates. The first of these is highly plausible; the second is, as far as I know, false in fact, but not implausible; while the third is quite unnatural, though not more so than the supposition, involved in Smarandache's Axiom III, that there are infinitely many distinct objects in any model of his system.

Existence postulates.

EP1. Mr. John Dee has four checking accounts, with balances of 5000, 5000, 5000 and 8000 dollars, respectively.

EP1 ensures the truth of Smarandache's Axiom II.3.

EP2. There are some checking accounts for whose balance two different banks are held responsible. I shall refer to such accounts as *two-bank* accounts.

EP2 is needed to ensure the truth of Smarandache's Axiom I.4; it is also presupposed by his Axiom I.6. We could be more specific and stipulate that checks drawn against such accounts will be cashed at the branches of either bank, that the banks share the maintenance costs and monthly service charges, etc. But all such details are irrelevant for the stated purpose..

EP3. There exist infinitely many supernatural persons who may secretly own bank accounts, usually in common.

EP3 is needed to take care of the last of the four situations contemplated in Smarandache's Axiom III (the Axiom of Parallels), which involves a point that is intersected by infinitely many lines. In our model, this amounts to a balance in current account that is owned in common by infinitely many persons. EP3 is certainly weird, but not more so than say, the postulation of points, lines and a plane at infinity in projective geometry. As in the latter case, we may regard talk of supernatural persons as a *façon de parler*. EP3 will perhaps sound less unlikely if the banks of our model are Swiss instead of American.

•

I shall now show that —with one partial exception (I.7)—all of the axioms of Smarandache's Anti-Geometry hold in our model. As we shall see, the said exception is due to an inconsistency in Smarandache's axiom system.

Axiom I.1 Two distinct points A and B do not always completely determine a line.

Balance A and balance B need not belong to the same person.

Axiom I.2 There is at least one line h and at least two distinct points A and B of h , such that A and B do not completely determine the line h .

A and B are owned by h in common with a second person k .

Axiom I.3 Three points A , B , C , not on the same line, do not always completely determine a plane α .

Three balances belonging to different persons may pertain to accounts they have with different banks.

Axiom I.4 There is at least one plane α and at least three points A , B , C , which lie on α but not on the same line, such that A , B , C do not completely determine the plane α .

Three points A , B and C on plane α completely determine α if and only if any fourth point D , coplanar with A , B and C , also lies on α . However, according to EP2, the balances A , B and C may pertain to three two-bank accounts held, say, with bank α and bank β . In that case, D could belong to β and not to α .

Axiom I.5 Let two points A , B of a line h lie on a plane α . This does not entail that every point of h lies on α .

Obviously, a person h may hold accounts with other banks, besides α .

Axiom I.6 Let two planes α and β have a point A in common. This does not entail that α and β have another point B in common.

Balance A could be the balance in the one and only two-bank account for which banks α and β are jointly responsible (see EP2).

Axiom I.7 There exist lines on each one of which there lies only one point, or planes on each one of which there lie only two points, or a space which contains only three points.

Nothing in our model precludes the joint fulfilment of the first two disjuncts in this axiom, viz., “There exist lines on each one of which there lies only one point” (i.e. persons who own a single bank account) and “There exist planes on each one of which there lie only two points” (i.e. banks in which, at closing time on the last day of the twentieth century, only two checking accounts remained open). The third condition, however, cannot be fulfilled, for EP1 demands the existence of at least four points. However, EP1 was solely introduced to secure the truth of Axiom II.3, which actually requires the existence of four distinct points. Therefore Axiom II.3 cannot be satisfied in a model that satisfies the last disjunct of Axiom I.7. Thus, the Smarandache axioms of anti-geometry are inconsistent as stated. I propose to delete the last disjunct of I.7. By the way, ‘space’ is not a term used in Hilbert’s axioms. Indeed, since ‘space’ stands for the entire domain of application of Smarandache’s system it ought not to occur in it either.

Axiom II.1 Let A, B, and C be three collinear points, such that B lies between A and C. This does not entail that B lies also between C and A.

Obviously, if $A = B < C$, $C \neq B$. Thus, in fact, our model satisfies also the stronger axiom: “If B lies between A and C then B does not lie between C and A”.

Axiom II.2 Let A and C be two collinear points. Then, there does not always exist a point B lying between A and C, nor a point D such that C lies between A and D.

Obviously, if a given person owns A and C there is no reason why she or he should own a third checking account, let alone one with a balance that is either equal to A and less than C, or greater than both C and A.

Axiom II.3 There exist at least three collinear points such that one point lies between the other two, and another point lies also between the other two.

This is so, of course, if the line is Mr. John Dee (by EP1).

Axiom II.4 Four collinear points A, B, C, D cannot always be ordered so that (i) B lies between A and C and also between A and D , and (ii) C lies between A and D and also between B and D .

In fact, under our definition of betweenness four collinear points can *never* be ordered in this way. Condition (i) means that B equals A and is less than C and D ; condition (ii) means that C equals A and B and is less than D . These two conditions are plainly incompatible.

Axiom II.5 Let $A, B,$ and C be three non-collinear points, and h a line which lies on the same plane as points $A, B,$ and C but does not pass through any of these points. Then, the line h may well pass through a point of segment AB , and yet not pass through a point of segment AC , nor through a point of segment BC

Suppose that h does not pass through A, B or C but passes nevertheless through a point of segment AB . This entails that person h owns in common with the owner of both A and B a checking account whose balance X is greater than A and less than B . Obviously, h need not own any balances in common with the owner of both B and C , nor with the owner of both A and C , let alone one that meets the requirements imposed by our definition of segment, viz., that the balance in question be greater than B and less than C , or greater than A and less than C .

III. ANTI-AXIOM OF PARALLELS

Let h be a line on a plane α and A a point on α but not on h . On plane α there can be drawn through point A either (i) no line, or (ii) only one line, or (iii) a finite number of lines, or (iv) an infinite number of lines which do(es) not intersect the line h . The line(s) is (are) called the parallel(s) to h through the given point A .⁶

⁶ Two remarks are on order here: (i) Chimienti and Bencze label this axiom with the Roman number III, although the Hilbert axiom contradicted by it bears number IV. In Hilbert's book Axioms III (1–5) are the axioms of congruence. (ii) Chimienti and Bencze do not

Let A be the balance of a checking account with bank α and h a client of bank α who does not own that account. The account in question may belong to a person who shares another balance with h (case i), or to a person b , or to finitely many persons c_1, \dots, c_n none of whom shares a checking account with h (cases ii and iii). According to EP3, A may also be owned secretly by infinitely many supernatural persons who do not share an account with h (case iv). By DEF. IV, the lines comprised in cases (ii), (iii) and (iv) all meet the requirements for being parallel with h .

NOTE. In Chimienti and Bencze's article (ref. 2), Axiom III includes the following supplementary condition, enclosed in parentheses: "(At least two of these situations should occur)", where 'these situations' are cases (i) through (iv). Since I do not understand what this condition means, I did not consider it in the preceding discussion. Anyway, the following is clear: No matter how you interpret the terms "point" and "line" and the predicates "coplanar" and "intersect", case (i) excludes cases (ii) and (iv). However, (i) implies (iii) and therefore can occur together with it, if by "finite number" you mean "any natural number" in Peano's sense, i.e. any integer equal to or greater than zero. In contemporary mathematical jargon, this would be the usual meaning of the term in this context. By the same token, (ii) implies (iii), for "one" is a finite number. Finally, (iv) certainly implies (iii), for any infinite set includes a finite subset. In the light of this, the condition in parenthesis is obvious and trivial and few would think of mentioning it. Therefore, the fact that it is mentioned suggests to me that it is being given some other meaning, which eludes me.

Axiom IV.1 If A, B are two points on a line h , and A' is a point on the same line or on another line h' , then, on a given side of A' on line h' , we cannot always find a unique B so that the segment AB is congruent to the segment $A'B'$.

If balances A and B belong to person h , and A' belongs to h' (who may or may not be the same person as h), there is no reason at all why there should exist a unique balance B' such that segments AB and $A'B'$ meet the condition of congruence, viz., that there exists a person x such that $\star(h,A,x)$ and $\star(h,B,x)$ and $\star(h',A',x)$ and $\star(h',B',x)$.

explicitly require line h to lie on plane α ; this is, however, a standard requirement of parallelism which I take to be understood.

NOTE. For the expression 'on a given side of A' ', see DEF. V.

Axiom IV.2 If segment AB is congruent with segment $A'B'$ and also with segment $A''B''$, then segment $A'B'$ is not always congruent with segment $A''B''$.

Assume that (i) the owner of A and B got the monies in the respective accounts partly from a person x and partly from a person y ; (ii) the owner of A' and B' got these monies partly from x but not from y ; (iii) the owner of A'' and B'' got these monies partly from y but not from x . If these three conditions are met, Axiom IV.2 is satisfied.

Axiom IV.3 If AB and BC are two segments of the same line h which have no points in common besides the point B , and $A'B'$ and $B'C'$ are two segments of h or of another line h' which have no points in common besides B' , and segment AB is congruent with segment $A'B'$ and segment BC is congruent with $B'C'$, then it is not always the case that segment AC is congruent with segment $A'C'$.

Again, let B and B' be acquired by h and h' , respectively, partly from x and partly from y ; A and A' from x but not from y ; C and C' from y but not from x . Then segment AB is congruent with segment $A'B'$; segment BC is congruent with segment $B'C'$, but segment AC is not congruent with segment $A'C'$.

Axiom IV.4. Let $\angle hOk$ be an angle on plan α , and let h' be a line on plane β . Suppose that a definite side of h' on plane β is assigned and that a particular point O' is distinguished on h' . Then there are on β either one, or more than one, or even no half-line k' issuing from the point O' such that (i) $\angle hOk$ is congruent with $\angle h'O'k'$, and (ii) the interior points of $\angle h'O'k'$ lie upon one or both sides of h' .

This axiom is not easy to apply, for it contains the terms 'half-line', 'interior points (of an angle)' and 'side (of a line on a plane)' which have not been defined and are not used anywhere else in the axioms. I shall take the *half-line k issuing from a point O* to mean a person k who owns O and owns another bank balance less than

O in a different account with the same bank, but does not own a bank balance greater than O in a different account with the same bank. As for the other two expressions, since they are otherwise idle, we could simply ignore them. But if the readers do not like this expedient, they may equally well use the following one: Let $\angle aPb$ be an angle, such that P is the balance held in common by a and b in their checking account with a particular branch of bank α ; the *interior points* of $\angle aPb$ are the cashiers of that particular branch. We say that the cashiers who are younger than a , lie *on one side* of a (on α), and that the cashiers who are older than a , lie *on the other side* of a (on α). The condition on interior points in axiom IV.4 will obviously be met if the line (i.e. bank client) h' is so chosen that the branch of bank β where h' holds the balance O' in common with k' has cashiers who are both younger and older than h' . Surely this requirement is not hard to meet, if β ranges freely over all banks in the U.S.

If the axiom is understood in this way, its meaning is clear enough. It is so weak that there is no difficulty in satisfying it. Take the arbitrarily assigned side of h' to be *younger than*. It should be easy to find a bank β and a client h' who owns a balance O' in a branch of β , and is older than some cashiers of the branch and younger than others. Under this condition, there may or may not be a person k' such that (i) k' holds O' in common with h' , (ii) k' holds separately a balance less than O' in another account with bank β (with my definitions this need not even be in the same branch of β), and (iii) there is a person x such that $\star(h, O, x)$ and $\star(k, O, x)$ and $\star(h', O', x)$ and $\star(k', O', x)$. Indeed, there may be several persons k_1, k_2, \dots, k_n , who simultaneously meet the conditions prescribed for k' .

Axiom IV.5 If $\angle hOk$ is congruent with $\angle h'O'k'$ and also with $\angle h''O''k''$, then $\angle h'O'k'$ may not be congruent with $\angle h''O''k''$.

Let $\angle hOk$ be congruent with $\angle h'O'k'$ because the vertices O and O' —i.e. the shared balances— both stem partly from a donor x who contributes nothing to O'' , while $\angle hOk$ is congruent with $\angle h''O''k''$ because the vertices O and O'' stem partly from a debtor y who contributes nothing to O' .

Axiom IV.6 Let ABC and $A'B'C'$ be two triangles such that segment AB is congruent with segment $A'B'$, segment AC is congruent with segment $A'C'$, and $\angle BAC$ is congruent with $\angle B'A'C'$. Then it is

not always the case that $\angle ABC$ is congruent with $\angle A'B'C'$ and that $\angle ACB$ is congruent with $\angle A'CB'$.

The triangle ABC is determined by three distinct balances A , B and C , such that A and B jointly belong to a person c , B and C jointly belong to a person a who is different from c , and C and A jointly belong to a person b who is different from both a and c . It follows that a and b are joint owners of C , b and c are joint owners of A , and c and a are joint owners of B . The axiom assumes:

- (i) That segment AB is congruent with segment $A'B'$, i.e. that there is a person x such that $\star(c,A,x)$ and $\star(c,B,x)$ and $\star(c',A',x)$ and $\star(c',B',x)$;
- (ii) That segment AC is congruent with segment $A'C'$, i.e. that there is a person y such that $\star(b,A,y)$ and $\star(b,C,y)$ and $\star(b',A',y)$ and $\star(b',C',y)$;
- (iii) That $\angle BAC$ is congruent with $\angle B'A'C'$, i.e. that there is a person z such that $\star(c,A,z)$ and $\star(b,A,z)$ and $\star(c',A',z)$ and $\star(b',A',z)$.

Obviously, conditions (i), (ii) and (iii) do not in any way imply that $\angle ABC$ is congruent with $\angle A'B'C'$, i.e., that there is a person v such that $\star(c,B,v)$ and $\star(a,B,v)$ and $\star(c',B',v)$ and $\star(a',B',v)$, nor that $\angle ACB$ is congruent with $\angle A'CB'$, i.e. that there is a person w such that $\star(b,C,w)$ and $\star(a,C,w)$ and $\star(b',C',w)$ and $\star(a',C',w)$.

ANTI-AXIOM OF CONTINUITY (ANTI-ARCHIMEDEAN AXIOM)

Let A , B be two points. Take the points A_1, A_2, A_3, A_4 , so that A_1 lies between A and A_2 , A_2 lies between A_1 and A_3 , A_3 lies between A_2 and A_4 , \dots , and the segments $AA_1, A_1A_2, A_2A_3, A_3A_4, \dots$ are congruent to one another. Then, among this series of points, there does not always exist a certain point A_n such that B lies between A and A_n .

Let A and B be two checking account balances. Consider a series of n checking account balances A_1, A_2, \dots, A_n , such that all of them belong to the owner of A , and all except A_n amount to the same sum as A . Suppose that A_n is greater than A . Now, the condition denied in the apodosis, viz., that B lies between A and A_n can hold if and only if B belongs to the owner of both A and A_n , and B is equal to A . Obviously this is not implied by the initial condition on B , viz., that B is a point, i.e. a checking account balance.

•

There is a simple moral to be drawn from this exercise. Because Smarandache Anti-Geometry has removed the stringent constraints on *points*, *lines* and *planes* prescribed by the Hilbert axioms, it is child's play to find uninteresting applications for it, like the one proposed above. When first confronted with this model, Dr. Minh L. Perez wrote me that he had the impression that Smarandache's message was directed against axiomatization. Such an attack would be justified only if we take an equalitarian view of axiom systems. To my mind, equalitarianism in the matter of mathematical axiom systems—though favored by some early twentieth century philosophers—is like placing all games of wit and skill on an equal footing. The clever Indian who invented chess is said to have demanded 2^{64} corn grains minus 1 for his creation. Who would have the chutzpah to charge even a trillionth of that for tic-tac-toe? But Smarandache's Anti-Euclidean geometry does not derogate Hilbert's axiom system for Euclidean geometry. Indeed this system, as well as Hilbert's axiom system for the real number field (1900a), deserve *much more*—not *less*—attention and praise in view of the fact that one can also propose consistent yet vapid axiom systems.

REFERENCES

- Chimienti, S. P. and M. Bencze. "Smarandache Anti-Geometry",
<http://www.gallup.unm.edu/~smarandache/prd-geo4.txt>.
- Frege, G. (1967). *Kleine Schriften*. Herausgegeben von I. Angelelli. Darmstadt: Wissenschaftliche Buchgesellschaft.
- Hilbert, D. (1899). "Grundlagen der Geometrie". In *Festschrift zur Feier der Enthüllung des Gauss-Weber-Denkmal in Göttingen*. Leipzig: Teubner. Pp. 3–92.
- Hilbert, D. (1900a). "Über den Zahlbegriff". *Jahresbericht der Deutschen Mathematischen Vereinigung*, 8: 180-194.
- Hilbert, D. (1900b). *Les principes fondamentaux de la géométrie*. Traduction de L. Laugel. Paris: Gauthier-Villars.
- Hilbert, D. (1903). *Grundlagen der Geometrie*. Zweite Auflage. Leipzig: Teubner.

THE AVERAGE SMARANDACHE FUNCTION

Florian Luca

Mathematical Institute, Czech Academy of Sciences

Žitná 25, 115 67 Praha 1

Czech Republic

For every positive integer n let $S(n)$ be the minimal positive integer m such that $n \mid m!$. For any positive number $x \geq 1$ let

$$A(x) = \frac{1}{x} \sum_{n \leq x} S(n) \quad (1)$$

be the average value of S on the interval $[1, x]$. In [6], the authors show that

$$A(x) < c_1 x + c_2 \quad (2)$$

where c_1 can be made rather small provided that x is enough large (for example, one can take $c_1 = .215$ and $c_2 = 45.15$ provided that $x > 1470$). It is interesting to mention that by using the method outlined in [6], one gets smaller and smaller values of c_1 for which (2) holds provided that x is large, but at the cost of increasing c_2 ! In the same paper, the authors ask whether it can be shown that

$$A(x) < \frac{2x}{\log x} \quad (3)$$

and conjecture that, in fact, the stronger version

$$A(x) < \frac{x}{\log x} \quad (4)$$

might hold (the authors of [6] claim that (4) has been tested by Ibstedt in the range $x \leq 5 \cdot 10^6$ in [4]. Although I have read [4] carefully, I found no trace of the aforementioned computation!).

In this note, we show that $\frac{x}{\log x}$ is indeed the correct order of magnitude of $A(x)$.

For any positive real number x let $\pi(x)$ be the number of prime numbers less than or equal to x ,

$$B(x) = xA(x) = \sum_{1 \leq n \leq x} S(n), \quad (5)$$

$$E(x) = 2.5 \log \log(x) + 6.2 + \frac{1}{x}. \quad (6)$$

We have the following result:

Theorem.

$$.5(\pi(x) - \pi(\sqrt{x})) < A(x) < \pi(x) + E(x) \quad \text{for all } x \geq 3. \quad (7)$$

Inequalities (7), combined with the prime number theorem, assert that

$$.5 \leq \liminf_{x \rightarrow \infty} \frac{A(x)}{\frac{x}{\log x}} \leq \limsup_{x \rightarrow \infty} \frac{A(x)}{\frac{x}{\log x}} \leq 1,$$

which says that $\frac{x}{\log x}$ is indeed the right order of magnitude of $A(x)$. The natural conjecture is that, in fact,

$$A(x) = \frac{x}{\log x} + O\left(\frac{x}{\log^2 x}\right). \quad (8)$$

Since

$$\frac{x}{\log x} \left(1 + \frac{1}{2 \log x}\right) < \pi(x) < \frac{x}{\log x} \left(1 + \frac{3}{2 \log x}\right) \quad \text{for } x \geq 59,$$

it follows, by our theorem, that the upper bound on $A(x)$ is indeed of the type (8). Unfortunately, we have not succeeded in finding a lower bound of the type (8) for $A(x)$.

The Proof

We begin with the following observation:

Lemma.

Suppose that $n = p_1^{\alpha_1} \dots p_k^{\alpha_k}$ is the decomposition of n in prime factors (we assume that the p_i 's are distinct but not necessarily ordered). Then:

1.
$$S(n) \leq \max_{i=1}^k (\alpha_i p_i). \quad (9)$$

2. Assume that $\alpha_1 p_1 = \max_{i=1}^k (\alpha_i p_i)$. If $\alpha_1 \leq p_1$, then $S(n) = \alpha_1 p_1$.

3.
$$S(n) > \alpha_i (p_i - 1) \quad \text{for all } i = 1, \dots, k. \quad (10)$$

Proof.

For every prime number p and positive integer k let $e_p(k)$ be the exponent at which p appears in $k!$.

1. Let $m \geq \max_{i=1}^k (\alpha_i p_i)$. Then

$$e_p(m) = \sum_{s \geq 1} \left\lfloor \frac{m}{p^s} \right\rfloor \geq \left\lfloor \frac{m}{p} \right\rfloor \geq \alpha_i \quad \text{for } i = 1, \dots, k.$$

This obviously implies $n \mid m!$, hence $m \geq S(n)$.

2. Assume that $\alpha_1 \leq p_1$. In this case, $S(n) \geq \alpha_1 p_1$. By 1 above, it follows that in fact $S(n) = \alpha_1 p_1$.

3. Let $m = S(n)$. The asserted inequality follows from

$$\alpha_i \leq e_{p_i}(m) = \sum_{s \geq 1} \left\lfloor \frac{m}{p_i^s} \right\rfloor < m \sum_{s \geq 1} \frac{1}{p_i^s} = \frac{m}{p_i - 1}.$$

The Proof of the Theorem.

In what follows p denotes a prime. We assume $x > 1$. The idea behind the proof is to find good bounds on the expression

$$B(x) - B(\sqrt{x}) = \sum_{\sqrt{x} < n \leq x} S(n). \quad (11)$$

Consider the following three subsets of the interval $I = (\sqrt{x}, x]$:

$$\begin{aligned} C_1 &= \{n \in I \mid S(n) \text{ is not a prime}\}, \\ C_2 &= \{n \in I \mid S(n) = p \leq \sqrt{x}\}, \\ C_3 &= \{n \in I \mid S(n) = p > \sqrt{x}\}. \end{aligned}$$

Certainly, the three subsets above are, in general, not disjoint but their union covers I . Let

$$D_i(x) = \sum_{n \in C_i} S(n) \quad \text{for } i = 1, 2, 3.$$

Clearly,

$$\max(D_i(x) \mid i = 1, 2, 3) \leq B(x) - B(\sqrt{x}) \leq D_1(x) + D_2(x) + D_3(x). \quad (12)$$

We now bound each D_i separately.

The bound for D_1 .

Assume that $m \in C_1$. By the Lemma, it follows that $S(m) \leq \alpha p$ for some $p^\alpha \parallel m$ and $\alpha > 1$. First of all, notice that $S(m) \leq \alpha\sqrt{m}$. Indeed, this follows from the fact that

$$S(m) \leq \alpha p \leq \alpha p^{\alpha/2} \leq \alpha\sqrt{m} \quad \text{for } \alpha \geq 2.$$

In particular, from the above inequality it follows that $p \leq \sqrt{m} \leq \sqrt{x}$. Write now $m = p^\alpha k$. Since $m \leq x$, it follows that $k \leq x/p^\alpha$. These considerations show that

$$D_1(x) < \sum_{p \leq \sqrt{x}} \sum_{\alpha \geq 2}^{\infty} \alpha p \cdot \frac{x}{p^\alpha} = x \sum_{p \leq \sqrt{x}} \sum_{\alpha \geq 2}^{\infty} \frac{\alpha}{p^{\alpha-1}} = x \sum_{p \leq \sqrt{x}} \frac{2p-1}{(p-1)^2}. \quad (13)$$

In the above formula (13), we used the fact that

$$\sum_{\alpha \geq 2} \alpha z^{\alpha-1} = \frac{d}{dz} \left(\frac{1}{1-z} \right) - 1 = \left(\frac{1}{1-z} \right)^2 - 1 = \frac{2z - z^2}{(1-z)^2} \quad \text{for } |z| < 1$$

with $z = 1/p$. Since

$$\frac{2p-1}{(p-1)^2} \leq \frac{5}{4p} \quad \text{for } p \geq 3,$$

it follows that

$$D_1(x) < x \left(3 - \frac{5}{8} + \frac{5}{4} \sum_{p \leq \sqrt{x}} \frac{1}{p} \right) = x \left(2.375 + 1.25 \sum_{p \leq \sqrt{x}} \frac{1}{p} \right). \quad (14)$$

From a formula from [5], we know that

$$\sum_{p \leq y} \frac{1}{p} < \log \log y + 1.27 \quad \text{for all } y > 1.$$

Hence, inequality (14) implies

$$D_1(x) < x \left(2.375 + 1.25 \left(\log \log \sqrt{x} + 1.27 \right) \right) < x \left(3.1 + 1.25 \log \log x \right). \quad (15)$$

The bound for D_2

Assume that $S(m) = p$. Then $m = py$ where p does not divide y . Since $m > \sqrt{x}$, it follows that

$$\frac{\sqrt{x}}{p} < y \leq \frac{x}{p}$$

Since $p \leq \sqrt{x}$, it follows that at least one integer in the above interval is a multiple of p ; hence, cannot be an acceptable value for y . This shows that there are at most

$$\left\lfloor \frac{x - \sqrt{x}}{p} \right\rfloor \leq \frac{x - \sqrt{x}}{p}$$

possible values for y . Hence,

$$D_2(x) \leq \sum_{p \leq \sqrt{x}} p \cdot \left(\frac{x - \sqrt{x}}{p} \right) \leq (x - \sqrt{x}) \pi(\sqrt{x}). \quad (16)$$

Bounds for D_3

Assume $S(m) = p$ for some $p > \sqrt{x}$. Then, $m = py$ for some $y < x/p$. Hence,

$$D_3(x) = \sum_{\sqrt{x} < p \leq x} p \cdot \left\lfloor \frac{x}{p} \right\rfloor. \quad (17)$$

Notice that, unlike in the previous cases, (17) is in fact an equality. Since $z \geq [z] > .5z$ for all real numbers $z > 1$, it follows, from formula (17), that

$$.5x(\pi(x) - \pi(\sqrt{x})) < D_3(x) < x(\pi(x) - \pi(\sqrt{x})). \quad (18)$$

Denote now by

$$F(x) = 3.1 + 1.25 \log \log(x)$$

From inequalities (12), (15), (16) and (17), it follows that

$$\begin{aligned} .5x(\pi(x) - \pi(\sqrt{x})) < D_3(x) < B(x) - B(\sqrt{x}) < D_1(x) + D_2(x) + D_3(x) < \\ xF(x) + (x - \sqrt{x})\pi(\sqrt{x}) + x(\pi(x) - \pi(\sqrt{x})) = x\pi(x) - \sqrt{x}\pi(\sqrt{x}) + xF(x). \end{aligned} \quad (19)$$

The left inequality (7) is now obvious since

$$B(x) > B(\sqrt{x}) + .5x(\pi(x) - \pi(\sqrt{x})) \geq 1 + .5x(\pi(x) - \pi(\sqrt{x})).$$

For the right inequality (7), let $G(x) = x\pi(x)$. Formula (19) can be rewritten as

$$B(x) - B(\sqrt{x}) < G(x) - G(\sqrt{x}) + xF(x). \quad (20)$$

Applying inequality (20) with x replaced by \sqrt{x} , $x^{1/4}$, ..., $x^{1/2^s}$ until $x^{1/2^s} < 2$ and summing up all these inequalities one gets

$$B(x) - B(1) < G(x) + \sum_{i=0}^s x^{1/2^i} F(x^{1/2^i}). \quad (21)$$

The function $F(x)$ is obviously increasing. Hence,

$$B(x) < 1 + G(x) + F(x) \sum_{i=0}^s x^{1/2^i}. \quad (22)$$

To finish the argument, we show that

$$x \geq \sum_{i=1}^s x^{1/2^i}. \quad (23)$$

Proceed by induction on s . If $s = 0$, there is nothing to prove. If $s = 1$, this just says that $x > \sqrt{x}$ which is obvious. Finally, if $s \geq 2$, it follows that $x \geq 4$. In particular, $x \geq 2\sqrt{x}$ or $x - \sqrt{x} \geq \sqrt{x}$. Rewriting inequality (23) as

s

which is precisely inequality (23) for \sqrt{x} . This completes the induction step. Via inequality (22), inequality (23) implies

$$B(x) < 1 + x\pi(x) + 2xF(x) = 1 + x\pi(x) + 2x(3.1 + 1.25 \log \log x) \quad (24)$$

or

$$A(x) < \pi(x) + \frac{1}{x} + 6.2 + 2.5 \log \log x = \pi(x) + E(x).$$

Applications

From the theorem, it follows easily that for every $\epsilon > 0$ there exists x_0 such that

$$A(x) < (1 + \epsilon) \frac{x}{\log x}. \quad (25)$$

In practice, finding a lower bound on x_0 for a given ϵ , one simply uses the theorem and the estimate

$$\pi(x) < \frac{x}{\log x} \left(1 + \frac{3}{2 \log x} \right) \quad \text{for } x > 1. \quad (26)$$

(see [5]). By (7) and (26), it now follows that (25) is satisfied provided that

$$\frac{x}{\log x} > \frac{1}{\epsilon} \left(\frac{3}{2 \log^2 x} + E(x) \right).$$

For example, when $\epsilon = 1$, one gets

$$A(x) < 2 \frac{x}{\log x} \quad \text{for } x \geq 64, \quad (27)$$

for $\epsilon = .5$, one gets

$$A(x) < 1.5 \frac{x}{\log x} \quad \text{for } x \geq 254 \quad (28)$$

and for $\epsilon = 0.1$ one gets

$$A(x) < 1.1 \frac{x}{\log x} \quad \text{for } x \geq 3298109. \quad (29)$$

Of course, inequalities (27)-(29) may hold even below the smallest values shown above but this needs to be checked computationally.

In the same spirit, by using the theorem and the estimation

$$\pi(x) > \frac{x}{\log x} \left(1 + \frac{1}{2 \log x} \right) \quad \text{for } x \geq 59$$

(see [5]) one can compute, for any given ϵ , an initial value x_0 such that

$$A(x) > (.5 - \epsilon) \frac{x}{\log x} \quad \text{for } x > x_0.$$

For example, when $\epsilon = 1/6$ one gets

$$A(x) > \frac{1}{3} \frac{x}{\log x} \quad \text{for } x \geq 59. \quad (30)$$

Inequality (30) above is better than the inequality appearing on page 62 in [2] which asserts that for every $\alpha > 0$ there exists x_0 such that

$$A(x) > x^{\alpha/x} \quad \text{for } x > x_0 \quad (31)$$

because the right side of (31) is bounded and the right side of (30) isn't!

A diophantine equation

In this section we present an application to a diophantine equation. The application is not of the theorem per se, but rather of the counting method used to prove the theorem.

Since S is defined in terms of factorials, it seems natural to ask how often the product $S(1) \cdot S(2) \cdot \dots \cdot S(n)$ happens to be a factorial.

Proposition.

The only solutions of

$$S(1) \cdot S(2) \cdot \dots \cdot S(n) = m! \quad (32)$$

are given by $n = m \in \{1, 2, \dots, 5\}$.

Proof.

We show that the given equation has no solutions for $n \geq 50$. Assume that this is not so. Let P be the largest prime number smaller than n . By Tchebysheff's theorem, we know that $P \geq n/2$. Since $S(P) = P$, it follows that $P \mid m!$. In particular, $P \leq m$. Hence, $m \geq n/2$.

We now compute an upper bound for the order of 2 in $S(1) \cdot S(2) \cdot \dots \cdot S(n)$. Fix some $\beta \geq 1$ and assume that k is such that $2^\beta \parallel S(k)$. Since

$$S(k) = \max(S(p^\alpha) \mid p^\alpha \parallel k),$$

it follows that $2^\beta \parallel S(p^\alpha)$ for some $p^\alpha \parallel k$.

We distinguish two situations:

Case 1.

p is odd. In this case, $2^\beta p \mid S(p^\alpha)$. If $\beta = 1$, then $\alpha = 2$. If $\beta = 2$, then $\alpha = 4$. For $\beta \geq 3$, one can easily check that $\alpha \geq 2^\beta - \beta + 1$ (indeed, if $\alpha \leq 2^\beta - \beta$, then one can check that $p^\alpha \mid (2^\beta p - 1)!$ which contradicts the definition of S). In particular, $p^{2^\beta - \beta + 1} \mid k$. Since $2^{x-1} \geq x + 1$ for $x \geq 3$, it follows that $\alpha \geq 2^{\beta-1} + 2$. Since $k \leq n$, the above arguments show that there are at most

$$\frac{n}{p^{2^\beta}} \quad \text{for } \beta = 1, 2$$

and

$$\frac{n}{p^{2^{\beta-1}+2}} \quad \text{for } \beta \geq 3$$

integers k in the interval $[1, n]$ for which $p \mid k$, $S(k) = S(p^\alpha)$, where α is such that $p^\alpha \parallel k$ and $2^\beta \parallel S(k)$.

Case 2.

$p = 2$. If $\beta = 1$, then $k = 2$. If $\beta = 2$, then $k = 4$. Assume now that $\beta \geq 3$. By an argument similar to the one employed at Case 1, one gets in this case that $\alpha \geq 2^\beta - \beta$. Since $2^\alpha \parallel k$, it follows that $2^{2^\beta - \beta} \mid k$. Since $k \leq n$, it follows that there are at most

$$\frac{n}{2^{2^\beta - \beta}}$$

such k 's.

From the above analysis, it follows that the order at which 2 divides $S(1) \cdot S(2) \cdot \dots \cdot S(n)$ is at most

$$e_2 < 3 + n \sum_{\substack{p \leq n \\ p \text{ odd}}} \left(\frac{1}{p^2} + \frac{2}{p^4} + \sum_{\beta \geq 3} \frac{\beta}{p^{2^{\beta-1}+2}} \right) + n \sum_{\beta \geq 3} \frac{\beta}{2^{2^\beta - \beta}}. \quad (38)$$

(the number 3 in the above formula counts the contributions of $S(2) = 2$ and $S(4) = 4$). We now bound each one of the two sums above.

For fixed p , one has

$$\frac{1}{p^2} + \frac{2}{p^4} + \sum_{\beta \geq 3} \frac{\beta}{p^{2^{\beta-1}+2}} = \frac{1}{p^2} + \frac{2}{p^4} + \frac{3}{p^6} + \frac{4}{p^{10}} + \dots < \sum_{\gamma \geq 1} \frac{\gamma}{p^{2^\gamma}} = \frac{p^2}{(p^2 - 1)^2}. \quad (39)$$

Hence,

$$\sum_{\substack{p \leq n \\ p \text{ odd}}} \left(\frac{1}{p^2} + \frac{2}{p^4} + \sum_{\beta \geq 3} \frac{\beta}{p^{2^{\beta-1}+2}} \right) < \sum_{p \text{ odd}} \frac{p^2}{(p^2-1)^2} < .245 \quad (40)$$

We now bound the second sum:

$$\begin{aligned} \sum_{\beta \geq 3} \frac{\beta}{2^{2^{\beta}-\beta}} &= \frac{3}{2^5} + \frac{4}{2^{12}} + \frac{5}{2^{27}} + \dots < \frac{3}{2^6} + \sum_{\beta \geq 3} \frac{\beta}{2^{2+4(\beta-2)}} = \\ &= \frac{3}{2^6} + \frac{1}{4} \left(\sum_{\gamma \geq 1} \frac{\gamma+2}{16^\gamma} \right) = \frac{3}{2^6} + \frac{1}{4} \left(\frac{15}{16} + \frac{31}{225} \right) < .099 \end{aligned} \quad (41)$$

From inequalities (38), (40) and (41), it follows that

$$e_2 < 3 + .344n. \quad (42)$$

We now compute a lower bound for e_2 . Since $e_2 = e_2(m!)$, it follows, from Lemme 1 in [1] and from the fact that $m \geq n/2$, that

$$e_2 \geq m - \frac{\log(m+1)}{\log 2} \geq \frac{n}{2} - \frac{\log(n/2+1)}{\log 2}. \quad (43)$$

From inequalities (42) and (43), it follows that

$$3 + .344n \geq .5n - \frac{\log(.5n+1)}{\log 2},$$

which gives $n \leq 50$. One can now compute $S(1) \cdot S(2) \cdot \dots \cdot S(n)$ for all $n \leq 50$ to conclude that the only instances when these products are factorials are $n = 1, 2, \dots, 5$.

We conclude suggesting the following problem:

Problem.

Find all positive integers n such that $S(1), S(2), \dots, S(n^2)$ can be arranged in a latin square.

The above problem appeared as Problem 24 in SNJ 9, (1994) but the range of solutions was restricted to $\{2, 3, 4, 5, 7, 8, 10\}$. The published solution was based on the simple observation that the sum of all entries in an $n \times n$ latin square has to be a multiple of n . By computing the sums $B(x^2)$ for x in the above range, one concluded that $B(x^2) \not\equiv 0 \pmod{x}$ which meant that there is no solution for such x 'ses. It is unlikely that this argument can be extended to cover the general case. One should notice that from our theorem, it follows that if a solution exists for some $n > 1$, then the size of the common sums of all entries belonging to the same row (or column) is $\cong n\pi(n^2)$.

Addendum

After this paper was written, it was pointed out to us by an anonymous referee that Finch [3] proved recently a much stronger statement, namely that

$$\lim_{x \rightarrow \infty} \frac{\log(x)}{x} \cdot A(x) = \frac{\pi^2}{12} = 0.82246703\dots \quad (44)$$

Finch's result is better than our result which only shows that the limsup of the expression $\log(x)A(x)/x$ when x goes to infinity is in the interval $[0.5, 1]$.

References

- [1] Y. Bugeaud & M. Laurent, "Minoration effective de la distance p -adique entre puissances de nombres algébriques", *J. Number Theory* **61** (1996), pp. 311-342.
- [2] C. Dumitrescu & V. Seleacu, "The Smarandache Function", Erhus U. Press, 1996.
- [3] S.R. Finch, "Moments of the Smarandache Function", *SNJ* **11**, No. 1-2-3 (2000), p. 140-142.
- [4] H. Ibsted, "Surfing on the ocean of numbers", Erhus U. Press, 1997.
- [5] J. B. Rosser & L. Schoenfeld, "Approximate formulas for some functions of prime numbers", *Illinois J. of Math.* **6** (1962), pp. 64-94.
- [6] S. Tabirca & T. Tabirca, "Two functions in number theory and some upper bounds for the Smarandache's function", *SNJ* **9** No. 1-2, (1998), pp. 82-91.

1991 AMS Subject Classification: 11A25, 11L20, 11L26.

A PARALLEL LOOP SCHEDULING ALGORITHM BASED ON THE SMARANDACHE f -INFERIOR PART FUNCTION

Tatiana Tabirca*

Sabin Tabirca**

*Department of Computer Science, Manchester University

**Department of Computer Science, "Transilvania" University of Brasov

Abstract. This article presents an application of the inferior Smarandache f -part function to a particular parallel loop-scheduling problem. The product between an upper diagonal matrix and a vector is analysed from parallel computation point of view. An efficient solution for this problem is given by using the inferior Smarandache f -part function. Finally, the efficiency of our solution is proved experimentally by presenting some computational results.

Parallel programming has been intensely developed in order to solve difficult problems that contain either a big number of computation or a large volume of data. These often occur both in real word applications (*e.g.* Weather Prediction) or theoretical problems (*e.g.* Differential Equations). Unfortunately, there is not a standard for writing parallel programs; this depends on the parallel language used or the parallel platform on which the computation is performed. A common fact of this diversity is represented by easiness to parallelise loops. Loops represent an important source of parallelism occurring in at most all the scientific applications. Many algorithms dealing to the scheduling of loop iterations to processors have been proposed so far.

1.Introduction

Consider that there are p processors denoted in the following by P_1, P_2, \dots, P_p and a single parallel loop (see Figure 1.).

```
DO PARALLEL I=1,N
    CALL LOOP_BODY(I)
END DO
```

Figure 1. Single Parallel Loop

We also assume that the work of the routine `loop_body(i)` can be evaluated and is given by the function $w: N \rightarrow R$, where $w(i) = w_i$ represents either the number of routine's operations or its running time (presume that $w(0)=0$). The total amount of work for the parallel loop is $\sum_{i=1}^N w(i)$. The efficient loop-scheduling algorithm distributes equally this total amount of work on processors such that a processor receives a quantity of work equal to $\frac{1}{p} \cdot \sum_{i=1}^N w(i)$.

Let l_j and h_j be the lower and upper loop iteration bounds, $j = 1, 2, \dots, p$, such that processor j executes all the iteration between l_j and h_j . These bounds are found distributing equally the work on processors by using

$$\sum_{i=l_j}^{h_j} w(i) \approx \frac{1}{p} \cdot \sum_{i=1}^N w(i) \quad (\forall j = 1, 2, \dots, p). \quad (1)$$

Moreover, they satisfy the following conditions

$$l_1 = 1. \quad (2.a)$$

$$\text{if we know } l_j, \text{ then } h_j \text{ is given by } \sum_{i=l_j}^{h_j} w(i) \approx \frac{1}{p} \cdot \sum_{i=1}^N w(i) = \overline{W}. \quad (2.b)$$

$$l_{j+1} = h_j + 1. \quad (2.c)$$

Suppose that Equation (2.b) is computed by a less approximation. This means that if we have the value l_j , then we find h_j as follows:

$$h_j = h \Leftrightarrow \sum_{i=l_j}^h w(i) \leq \overline{W} < \sum_{i=l_j}^{h+1} w(i). \quad (3)$$

In the following, we present an optimal parallel solution for the product between an upper diagonal matrix and a vector. This is an important problem that occurs in many algorithms for solving linear systems. The Smarandache inferior part function is used to distribute equally the work on processors.

2. The Smarandache Inferior Part Function

The inferior part function (sometime is named the floor function) $[,]: R \rightarrow Z$, defined by $[x] = k \Leftrightarrow k \leq x < k + 1$, is one of the most used elementary functions. The Smarandache inferior part function represents a natural generalisation of the floor function [Smara1]. Smarandache proposed and studied this generalisation especially in connection to Number Theory functions [Smara1, Smara2]. In the following, we present equation for some Smarandache inferior part functions.

Consider $f: Z \rightarrow R$ a function that is strict increasing and satisfies $\lim_{n \rightarrow -\infty} f(n) = -\infty$ and $\lim_{n \rightarrow \infty} f(n) = \infty$. The Smarandache f -inferior part function denoted by $f_{\square}: R \rightarrow Z$ is defined by

$$f_{\square}(x) = k \Leftrightarrow f(k) \leq x < f(k + 1). \quad (4)$$

The function f_{\square} is well defined because of the good properties of f . When $f(k) = k$ the floor function $[x]$ is obtained. In the following we study the Smarandache f -inferior part function when $f(k) = \sum_{i=1}^k i^a$.

Remark. Sometime, we will study only the positive inferior part by considering function $f: N \rightarrow R, f(0) = 0$. In this case, we only consider $f_{\square}: [0, \infty) \rightarrow Z$.

Theorem 1. If $f(k) = \sum_{i=1}^k i$, then the Smarandache f -inferior part is given by

$$f_{\square}(x) = \left\lfloor \frac{-1 + \sqrt{1 + 8 \cdot x}}{2} \right\rfloor \forall x \geq 0. \quad (5)$$

Proof The proof is obtained by starting from the double inequality $\sum_{i=1}^k i \leq x < \sum_{i=1}^{k+1} i$.

Observe that the equation $\frac{k \cdot (k + 1)}{2} = x > 0$ has only one positive root given by

$k = \frac{-1 + \sqrt{1 + 8 \cdot x}}{2} > 0$. The following equivalences prove Theorem 1

$$\begin{aligned} \sum_{i=1}^k i \leq x < \sum_{i=1}^{k+1} i &\Leftrightarrow \frac{k \cdot (k + 1)}{2} \leq x < \frac{(k + 1) \cdot (k + 2)}{2} \Leftrightarrow \\ &\Leftrightarrow k \leq \frac{-1 + \sqrt{1 + 8 \cdot x}}{2} < k + 1 \Leftrightarrow k = \left\lfloor \frac{-1 + \sqrt{1 + 8 \cdot x}}{2} \right\rfloor. \end{aligned}$$

Thus, the equation for the Smarandache f -inferior part is $f_0(x) = \left[\frac{-1 + \sqrt{1 + 8 \cdot x}}{2} \right]$.

◆

Theorem 2. If $f(k) = \sum_{i=1}^k i^2$, then the Smarandache f -inferior part is given by

$$f_0(x) = \left[-\frac{1}{2} + \sqrt[3]{\frac{3 \cdot x}{2} - \sqrt{\left(\frac{3 \cdot x}{2}\right)^2 + \frac{1}{1728}}} + \sqrt[3]{\frac{3 \cdot x}{2} + \sqrt{\left(\frac{3 \cdot x}{2}\right)^2 + \frac{1}{1728}}} \right] \forall x \geq 0. \quad (6)$$

Proof We use the Cardano equation for solving $x^3 + px + q = 0$. A real root of this equation is given by

$$x = \sqrt[3]{-\frac{q}{2} - \sqrt{\left(\frac{q}{2}\right)^2 + \left(\frac{p}{3}\right)^3}} + \sqrt[3]{-\frac{q}{2} + \sqrt{\left(\frac{q}{2}\right)^2 + \left(\frac{p}{3}\right)^3}}. \quad (7)$$

The equation $\frac{k \cdot (k+1) \cdot (2 \cdot k+1)}{6} = x > 0$ is transformed as follows:

$$\frac{k \cdot (k+1) \cdot (2 \cdot k+1)}{6} = x \Leftrightarrow 2 \cdot k^3 + 3 \cdot k^2 + k - 6x = 0 \Leftrightarrow$$

$$\Leftrightarrow \left(\text{apply the transformation } k = y - \frac{1}{2}\right) \Leftrightarrow y^3 - \frac{1}{4} \cdot y - 3 \cdot x = 0.$$

Applying Equation (7), we find that

$$y = \sqrt[3]{\frac{3 \cdot x}{2} - \sqrt{\left(\frac{3 \cdot x}{2}\right)^2 + \frac{1}{1728}}} + \sqrt[3]{\frac{3 \cdot x}{2} + \sqrt{\left(\frac{3 \cdot x}{2}\right)^2 + \frac{1}{1728}}} \text{ and}$$

$$k = -\frac{1}{2} + \sqrt[3]{\frac{3 \cdot x}{2} - \sqrt{\left(\frac{3 \cdot x}{2}\right)^2 + \frac{1}{1728}}} + \sqrt[3]{\frac{3 \cdot x}{2} + \sqrt{\left(\frac{3 \cdot x}{2}\right)^2 + \frac{1}{1728}}}.$$

The Smarandache f -inferior part is given by:

$$\sum_{i=1}^k i^2 \leq x < \sum_{i=1}^{k+1} i^2 \Leftrightarrow \frac{k \cdot (k+1) \cdot (2 \cdot k+1)}{6} \leq x < \frac{(k+1) \cdot (k+2) \cdot (2 \cdot k+3)}{6} \Leftrightarrow$$

$$\Leftrightarrow k \leq -\frac{1}{2} + \sqrt[3]{\frac{3 \cdot x}{2} - \sqrt{\left(\frac{3 \cdot x}{2}\right)^2 + \frac{1}{1728}}} + \sqrt[3]{\frac{3 \cdot x}{2} + \sqrt{\left(\frac{3 \cdot x}{2}\right)^2 + \frac{1}{1728}}} < k+1 \Leftrightarrow$$

$$\Leftrightarrow k = \left[-\frac{1}{2} + \sqrt[3]{\frac{3 \cdot x}{2} - \sqrt{\left(\frac{3 \cdot x}{2}\right)^2 + \frac{1}{1728}}} + \sqrt[3]{\frac{3 \cdot x}{2} + \sqrt{\left(\frac{3 \cdot x}{2}\right)^2 + \frac{1}{1728}}} \right]. \quad \blacklozenge$$

3. An Efficient Algorithm for the Upper Diagonal Matrix-Vector Product

In this section, we present an efficient algorithm for the product $y = a \cdot x$ between an upper diagonal matrix $a = (a_{i,j})_{i,j=1,\overline{n}} \in M_n(R)$ and a vector $x \in R^n$. This problem is quite important occurring in several other important problems such as solving linear systems or LUP matrix decomposition.

Because a is an upper diagonal matrix, the product $y = a \cdot x$ is given by

$$y_i = \sum_{j=1}^i a_{i,j} \cdot x_j \quad \forall i = 1, 2, \dots, n. \quad (8)$$

The product can be computed in parallel by using a simple computation shown below.

```

DO PARALLEL i=1,n
  y_i = 0
  DO j=1,i
    y_i = y_i + a_{i,j} \cdot x_j
  END DO
END DO

```

Figure 2. Parallel Computation for the Upper Matrix – Vector Product.

For this parallel loop we have the following elements:

- The work of iteration i is $w(i) = i, i = 1, 2, \dots, n$; the total work is

$$\sum_{i=1}^n i = \frac{n \cdot (n+1)}{2}.$$

- The quantity of work received by a processor should be approximately equal

$$\text{to } \overline{W} = \frac{n \cdot (n+1)}{2 \cdot p}$$

The difficult problem for the efficient loop scheduling algorithm is how Equation (1) is implemented. To find the upper bounds from this is quite expensive and can be done in $O(\log n + \frac{n}{p})$ [Jaja]. But, we want to find the upper bounds in at most $O(p)$

complexity and we show that this is possible for our problem. For that we use the following theorem

Theorem 3. *The parallel computation for the upper matrix-vector product can efficiently be scheduled on processors (with respect of Equation 1) by using the following upper bounds:*

$$h_j = \left\lceil \frac{-1 + \sqrt{1 + 4 \cdot j \cdot \frac{n \cdot (n+1)}{p}}}{2} \right\rceil, j=1,2,\dots,p. \quad (9)$$

Proof The Smarandache f -inferior part function presented in Theorem 1 is used to

obtain the proof. We found that if $f(k) = \sum_{i=1}^k i$ then $f_{\square}(x) = \left\lceil \frac{-1 + \sqrt{1 + 8 \cdot x}}{2} \right\rceil \forall x \geq 0$.

Since each processor receives a quantity equal to $\overline{W} = \frac{n \cdot (n+1)}{2 \cdot p}$, we find that the

first $j-1$ processors have received approximately $(j-1) \cdot \overline{W}$. Thus, the upper bound of processor j is the biggest number k such that all the previous work done by processors $1,2,\dots,j$ should be approximately equal to $j \cdot \overline{W}$. Mathematically, this can be written as follows

$$\begin{aligned} 1+2+\dots+h_j &\leq j \cdot \overline{W} < 1+2+\dots+h_j + (h_j + 1) \Leftrightarrow \\ \Leftrightarrow h_j &= f_{\square}(j \cdot \overline{W}) = \left\lceil \frac{-1 + \sqrt{1 + 8 \cdot j \cdot \overline{W}}}{2} \right\rceil \Leftrightarrow \\ \Leftrightarrow h_j &= \left\lceil \frac{-1 + \sqrt{1 + 4 \cdot j \cdot \frac{n \cdot (n+1)}{p}}}{2} \right\rceil, j=1,2,\dots,p \end{aligned}$$

A more rigorous and technical explanation can be found in [Tabi]. ◆

According to this theorem, the efficient scheduling is obtained using the upper bound from Equation (9). These bounds certainly give the better approximation of Equation 1. Thus, the part of parallel loop scheduled on processor j is presented in Figure 3. This processor computes all the sums of Equation (8) between $h_{j-1} + 1$ and h_j .

```

DO i = [ -1 + sqrt(1 + 4 * (j-1) * (n * (n+1) / p)) / 2 ] + 1, [ -1 + sqrt(1 + 4 * j * (n * (n+1) / p)) / 2 ]
  y_i = 0
  DO j = 1, i
    y_i = y_i + a_{i,j} * x_j
  END DO
END DO

```

Figure 3. Computation of Processor j .

4. Computational Results and Final Conclusions

This section presents some computational results of scheduling the parallel loop from Figure 3. In order to find that the proposed method is efficient from the practical point of view, two other scheduling algorithms are used. The first scheduling algorithm named *uniform scheduling*, divides the parallel loop into p chunks with the same size $\left\lceil \frac{n}{p} \right\rceil$. Obviously, this represents the simplest scheduling strategy but is inefficient because all the big sums are computed on processor p . The second scheduling algorithm named *interleaving*, distributes the work on processors from p to p , such that a processor does not compute two consecutive works. This scheduling distributes the large work equally on processors. All the algorithms have been executed on SGI Power Challenge 2000 parallel machine with 16 processors for a upper diagonal matrix of dimension 300. The running time are presented in Table 1.

	$P=1$	$P=2$	$P=3$	$P=6$	$P=8$
Balanced	1.878	1.377	0.974	0.760	0.472
Interleaving	2.029	1.447	1.041	0.803	0.576
Uniform	2.028	2.122	1.660	1.335	0.970

Table 1. Computational Times for three Scheduling Algorithms.

The first important remark that can be outlined is that there is no way to develop efficient methods in Computer Science without Mathematics and this article is a prove for that. Using a special function named the Smarandache inferior part, it has

been possible to find an efficient scheduling algorithm for the upper diagonal matrix-vector product.

The second important remark is that the scheduling proposed in this article is efficient in practice as well. Table 1 shows that the times for the line **balanced** are smallest. It can be seen that the interleaving strategy also offers good times. Table 1 also shows that the uniform strategy gives the largest times.

References

- [Jaja] J.Jaja, (1992) Introduction to Parallel Algorithms, Adison-Wesley.
- [Smar1] F. Smarandache, A Generalisation of The Inferior Part Function, <http://www.gallup.unm.edu/~smarandache>.
- [Smar2] F.Smarandache, (1993) Only Problems ... Not Solutions, Xiquan Publishing House, Phoenix-Chicago.
- [Tabi]T. Tabirca and S. Tabirca, (2000) Balanced Work Loop-Scheduling, Technical Report, Department of Computer Science, Manchester University. [*In Preparation*]

On the Pseudo-Smarandache Function and Iteration Problems

Part I. The Euler ϕ function

Henry Ibstedt

Abstract: This study originates from questions posed on alternating iterations involving the pseudo-Smarandache function $Z(n)$ and the Euler function $\phi(n)$. An important part of the study is a formal proof of the fact that $Z(n) < n$ for all $n \neq 2^k$ ($k \geq 0$). Interesting questions have been resolved through the surprising involvement of Fermat numbers.

I. The behaviour of the pseudo-Smarandache function

Definition of the Smarandache pseudo function $Z(n)$: $Z(n)$ is the smallest positive integer m such that $1+2+\dots+m$ is divisible by n .

Adding up the arithmetical series results in an alternative and more useful formulation: For a given integer n , $Z(n)$ equals the smallest positive integer m such that $m(m+1)/2n$ is an integer. Some properties and values of this function are given in [1], which also contains an effective computer algorithm for calculation of $Z(n)$. The following properties are evident from the definition:

1. $Z(1)=1$
2. $Z(2)=3$
3. For any odd prime p , $Z(p^k)=p^k-1$ for $k \geq 1$
4. For $n=2^k$, $k \geq 1$, $Z(2^k)=2^{k+1}-1$

We note that $Z(n)=n$ for $n=1$ and that $Z(n) > n$ for $n=2^k$ when $k \geq 1$. Are there other values of n for which $Z(n) \geq n$? No, there are none, but to my knowledge no proof has been given. Before presenting the proof it might be useful to see some elementary results and calculations on $Z(n)$. Explicit calculations of $Z(3 \cdot 2^k)$ and $Z(5 \cdot 2^k)$ have been carried out by Charles Ashbacher [2]. For $k > 0$:

$$Z(3 \cdot 2^k) = \begin{cases} 2^{k+1}-1 & \text{if } k \equiv 1 \pmod{2} \\ 2^{k+1} & \text{if } k \equiv 0 \pmod{2} \end{cases}$$

$$Z(5 \cdot 2^k) = \begin{cases} 2^{k+2} & \text{if } k \equiv 0 \pmod{4} \\ 2^{k+1} & \text{if } k \equiv 1 \pmod{4} \\ 2^{k+2}-1 & \text{if } k \equiv 2 \pmod{4} \\ 2^{k+1}-1 & \text{if } k \equiv 3 \pmod{4} \end{cases}$$

A specific remark is made in each case that $Z(n) < n$.

Before proceeding to the theorem a study of $Z(a \cdot 2^k)$, a odd and $k > 0$, we will carry out a specific calculation for $n=7 \cdot 2^k$.

We look for the smallest integer m for which $\frac{m(m+1)}{7 \cdot 2^{k+1}}$ is integer. We distinguish two cases:

Case 1:

$$m=7x$$

$$m+1=2^{k+1}y$$

Eliminating m results in

$$2^{k+1}y-1=7x$$

$$2^{k+1}y \equiv 1 \pmod{7}$$

Since $2^3 \equiv 1 \pmod{3}$ we have

If $k \equiv -1 \pmod{3}$ then

$$y \equiv 1 \pmod{7}; m=2^{k+1}-1$$

If $k \equiv 0 \pmod{3}$ then

$$2y \equiv 1 \pmod{7}, y=4; m=2^{k+1} \cdot 4 - 1 = 2^{k+3} - 1$$

If $k \equiv 1 \pmod{3}$ then

$$4y \equiv 1 \pmod{7}, y=2; m=2^{k+1} \cdot 2 - 1 = 2^{k+2} - 1$$

Case 2:

$$m=2^{k+1}y$$

$$m+1=7x$$

$$2^{k+1}y+1=7x$$

$$2^{k+1}y \equiv -1 \pmod{7}$$

$$y \equiv 8 \pmod{7}; m=2^{k+1} \cdot 8 = 2^{k+4}$$

$$y \equiv 3 \pmod{7}; m=3 \cdot 2^{k+1}$$

$$y \equiv 5 \pmod{7}; m=5 \cdot 2^{k+1}$$

By choosing in each case the smallest m we find:

$$Z(7 \cdot 2^k) = \begin{cases} 2^{k+1} - 1 & \text{if } k \equiv -1 \pmod{3} \\ 3 \cdot 2^{k+1} & \text{if } k \equiv 0 \pmod{3} \\ 2^{k+2} - 1 & \text{if } k \equiv 1 \pmod{3} \end{cases}$$

Again we note that $Z(n) < n$.

In a study of alternating iterations [3] it is stated that apart from when $n=2^k$ ($k \geq 0$) $Z(n)$ is at most n . If it ever happened that $Z(n)=n$ for $n > 1$ then the iterations of $Z(n)$ would arrive at an invariant, i.e. $Z(\dots Z(n) \dots) = n$. This can not happen, therefore it is important to prove the following theorem.

Theorem: $Z(n) < n$ for all $n \neq 2^k$, $k \geq 0$.

Proof: Write n in the form $n = a \cdot 2^k$, where a is odd and $k > 0$. Consider the following four cases:

1. $a \cdot 2^{k+1} \mid m$
2. $a \cdot 2^{k+1} \mid (m+1)$
3. $a \mid m$ and $2^{k+1} \mid (m+1)$
4. $2^{k+1} \mid m$ and $a \mid (m+1)$

If a is composite we could list more cases but this is not important as we will achieve our goal by finding m so that $Z(n) \leq m < n$ (where we will have $Z(n)=m$ in case a is prime)

Cases 1 and 2:

Case 1 is excluded in favor of case 2 which would give $m = a \cdot 2^{k+1} - 1 > n$. We will see that also case 2 be excluded in favor of cases 3 and 4.

Case 3 and 4. In case 3 we write $m=ax$. We then require $2^{k+1} \mid (ax+1)$, which means that we are looking for solutions to the congruence

$$ax \equiv -1 \pmod{2^{k+1}} \quad (1)$$

In case 4 we write $m+1=ax$ and require $2^{k+1} \mid (ax-1)$. This corresponds to the congruence

$$ax \equiv 1 \pmod{2^{k+1}} \quad (2)$$

If $x=x_1$ is a solution to one of the congruencies in the interval $2^k < x < 2^{k+1}$ then $2^{k+1}-x_1$ is a solution to the other congruence which lies in the interval $0 < x < 2^k$. So we have $m=ax$ or $m=ax-1$ with $0 < x < 2^k$, i.e. $m < n$ exists so that $m(m+1)/2$ is divisible by n when $a > 1$ in $n=a \cdot 2^k$. If a is a prime number then we also have $Z(n)=m < n$. If $a=a_1 \cdot a_2$ then $Z(n) \leq m$ which is a fortiori less than n .

Let's illustrate the last statement by a numerical example. Take $n=70 = 5 \cdot 7 \cdot 2$. An effective algorithm for calculation of $Z(n)$ [1] gives $Z(70)=20$. Solving our two congruencies results in:

$$\begin{array}{ll} 35x \equiv -1 \pmod{4} & \text{Solution } x=1 \text{ for which } m=35 \\ 35x \equiv 1 \pmod{4} & \text{Solution } x=3 \text{ for which } m=104 \end{array}$$

From these solutions we chose $m=35$ which is less than $n=70$. However, here we arrive at an even smaller solution $Z(70)=20$ because we do not need to require both a_1 and a_2 to divide one or the other of m and $m+1$.

II. Iterating the Pseudo-Smarandache Function

The theorem proved in the previous section assures that an iteration of the pseudo-Smarandache function does not result in an invariant, i.e. $Z(n) \neq n$ is true for $n \neq 1$. On iteration the function will leap to a higher value only when $n=2^k$. It can only go into a loop (or cycle) if after one or more iterations it returns to 2^k . Up to $n=2^{28}$ this does not happen and a statistical view on the results displayed in diagram 1 makes it reasonable to conjecture that it never happens. Each row in diagram 1 corresponds to a sequence of iterations starting on $n=2^k$ finishing on the final value 2. The largest number of iterations required for this was 24 and occurred for $n=2^{14}$ which also had the largest numbers of leaps from 2^j to $2^{j+1}-1$. Leaps are represented by \uparrow in the diagram. For $n=2^{11}$ and 2^{12} the iterations are monotonously decreasing.

III. Iterating the Euler ϕ function

The function $\phi(n)$ is defined for $n > 1$ as the number of positive integers less than and prime to n . The analytical expression is given by

$$\phi(n) = n \prod_{p \mid n} \left(1 - \frac{1}{p}\right)$$

k/j	28	27	26	25	24	23	22	21	20	19	18	17	16	15	14	13	12	11	10	9	8	7	6	5	4	3	2
2																											↑
3																										↑	↑
4																									↑	↑	↑
5																								↑	↑	↑	↑
6																								↑	↑	↑	↑
7																							↑	↑	↑	↑	↑
8																							↑	↑	↑	↑	↑
9																							↑	↑	↑	↑	↑
10																							↑	↑	↑	↑	↑
11																							↑	↑	↑	↑	↑
12																							↑	↑	↑	↑	↑
13																							↑	↑	↑	↑	↑
14																							↑	↑	↑	↑	↑
15																							↑	↑	↑	↑	↑
16																							↑	↑	↑	↑	↑
17																							↑	↑	↑	↑	↑
18																							↑	↑	↑	↑	↑
19																							↑	↑	↑	↑	↑
20																							↑	↑	↑	↑	↑
21																							↑	↑	↑	↑	↑
22																							↑	↑	↑	↑	↑
23																							↑	↑	↑	↑	↑
24																							↑	↑	↑	↑	↑
25																							↑	↑	↑	↑	↑
26																							↑	↑	↑	↑	↑
27																							↑	↑	↑	↑	↑
28																							↑	↑	↑	↑	↑

Diagram 1.

For n expressed in the form $n = p_1^{\alpha_1} p_2^{\alpha_2} \dots p_r^{\alpha_r}$ it is often useful to express $\phi(n)$ in the form

$$\phi(n) = p_1^{\alpha_1-1}(p_1 - 1)p_2^{\alpha_2-1}(p_2 - 1)\dots p_r^{\alpha_r-1}(p_r - 1)$$

It is obvious from the definition that $\phi(n) < n$ for all $n > 1$. Applying the ϕ function to $\phi(n)$ we will have $\phi(\phi(n)) < \phi(n)$. After a number of such iterations the end result will of course be 1. It is what this chain of iterations looks like which is interesting and which will be studied here. For convenience we will write $\phi_2(n)$ for $\phi(\phi(n))$. $\phi_k(n)$ stands for the k^{th} iteration. To begin with we will look at the iteration of a few prime powers.

$$\phi(2^\alpha) = 2^{\alpha-1}, \quad \phi_k(2^\alpha) = 2^{\alpha-k}, \quad \dots \quad \phi_\alpha(2^\alpha) = 1.$$

$$\phi(3^\alpha) = 3^{\alpha-1} \cdot 2, \quad \phi_2(3^\alpha) = 3^{\alpha-2} \cdot 2, \quad \dots \quad \phi_k(3^\alpha) = 3^{\alpha-k} \cdot 2 \text{ for } k \leq \alpha.$$

$$\text{In particular } \phi_\alpha(3^\alpha) = 2.$$

Proceeding in the same way we will write down $\phi_k(p^\alpha)$, $\phi_\alpha(p^\alpha)$ and first first occurrence of an iteration result which consists purely of a power of 2.

$$\begin{array}{lll}
\phi_k(5^\alpha)=5^{\alpha-k}\cdot 2^{k+1}, k\leq\alpha & \phi_\alpha(5^\alpha)=2^{\alpha+1} & \\
\phi_k(7^\alpha)=7^{\alpha-k}\cdot 3\cdot 2^k, k\leq\alpha & \phi_\alpha(7^\alpha)=3\cdot 2^\alpha, & \phi_{\alpha+1}(7^\alpha)=2^\alpha. \\
\phi_k(11^\alpha)=11^{\alpha-k}\cdot 5\cdot 2^{2k-1}, k\leq\alpha & \phi_\alpha(11^\alpha)=5\cdot 2^{2\alpha-1} & \phi_{\alpha+1}(11^\alpha)=2^{2\alpha}. \\
\phi_k(13^\alpha)=13^{\alpha-k}\cdot 3\cdot 2^{2k}, k\leq\alpha & \phi_\alpha(13^\alpha)=3\cdot 2^{2\alpha} & \phi_{\alpha+1}(13^\alpha)=2^{2\alpha}. \\
\phi_k(17^\alpha)=17^{\alpha-k}\cdot 2^{3k+1}, k\leq\alpha & \phi_\alpha(17^\alpha)=2^{3\alpha+1}. & \\
\phi_k(19^\alpha)=19^{\alpha-k}\cdot 3^{k+1}\cdot 2^k, k\leq\alpha & \phi_\alpha(19^\alpha)=3^{\alpha+1}\cdot 2^\alpha & \phi_{2\alpha+1}(19^\alpha)=2^\alpha. \\
\phi_k(23^\alpha)=23^{\alpha-k}\cdot 11\cdot 5\cdot 2^{3k-4}, k\leq\alpha & \phi_\alpha(23^\alpha)=11\cdot 5\cdot 2^{3\alpha-4} & \phi_{\alpha+2}(23^\alpha)=2^{3\alpha-1}.
\end{array}$$

Table 1. Iteration of p^6 . A horizontal line marks where the rest of the iterated values consist of descending powers of 2

#	p=2	p=3	p=5	p=7	p=11	p=13	p=17	p=19	p=23
1	32	486	12500	100842	1610510	4455516	22717712	44569782	141599546
2	16	162	5000	28812	585640	1370928	10690688	14074668	61565020
3	8	54	2000	8232	212960	421824	5030912	4444632	21413920
4	4	18	800	2352	77440	129792	2367488	1403568	7448320
5	2	6	320	672	28160	39936	1114112	443232	2590720
6		2	128	192	10240	12288	524288	139968	901120
7			64	64	4096	4096	262144	46656	327680
8			32	32	2048	2048	131072	15552	131072
9			16	16	1024	1024	65536	5184	65536
10			8	8	512	512	32768	1728	32768
11			4	4	256	256	16384	576	16384
12			2	2	128	128	8192	192	8192
13					64	64	4096	64	4096
14					32	32	2048	32	2048
15					16	16	1024	16	1024
16					8	8	512	8	512
17					4	4	256	4	256
18					2	2	128	2	128
19							64		64
20							32		32
21							16		16
22							8		8
23							4		4
24							2		2

The characteristic tail of descending powers of 2 applies also to the iterations of composite integers and plays an important role in the alternating Z - ϕ iterations which will be subject of the next section.

IV. The alternating iteration of the Euler ϕ function followed by the Smarandache Z function.

Charles Ashbacher [3] found that the alternating iteration $Z(\dots(\phi(Z(\phi(n))))\dots)$ ends in 2-cycles of which he found the following four¹:

2-cycle	First Instance
2 - 3	$3=2^2-1$
8 - 15	$15=2^4-1$
128 - 255	$255=2^8-1$
32768 - 65535	$65535=2^{16}-1$

The following questions were posed:

1) Does the Z- ϕ sequence always reduce to a 2-cycle of the form $2^{2^r-1} \leftrightarrow 2^{2^r} - 1$ for $r \geq 1$?

2) Does any additional patterns always appear first for $n = 2^{2^r} - 1$?

Theorem: The alternating iteration $Z(\dots(\phi(Z(\phi(n))))\dots)$ ultimately leads to one of the following five 2-cycles: 2 - 3, 8 - 15, 128 - 255, 32768 - 65535, 2147483648 - 4294967295.

Proof:

Since $\phi(n) < n$ for all $n > 1$ and $Z(n) < n$ for all $n \neq 2^k$ ($k \geq 0$) any cycle must have a number of the form 2^k at the lower end and $Z(2^k) = 2^{k+1} - 1$ at the upper end of the cycle. In order to have a 2-cycle we must find a solution to the equation

$$\phi(2^{k+1}-1) = 2^k$$

If $2^{k+1}-1$ were a prime $\phi(2^{k+1}-1)$ would be $2^{k+1}-2$ which solves the equation only when $k=1$. A necessary condition is therefore that $2^{k+1}-1$ is composite, $2^{k+1}-1 = f_1 \cdot f_2 \cdot \dots \cdot f_r$ and that the factors are such that $\phi(f_i) = 2^{u_i}$ for $1 \leq i \leq r$. But this means that each factor f_i must be a prime number of the form $2^{u_i} + 1$. This leads us to consider

$$q(r) = (2-1)(2+1)(2^2+1)(2^4+1)(2^8+1) \dots (2^{2^{r-1}} + 1)$$

or

$$q(r) = (2^{2^r} - 1)$$

Numbers of the form $F_r = 2^{2^r} + 1$ are known as Fermat numbers. The first five of these are prime numbers

$$F_0=3, F_1=5, F_2=17, F_3=257, F_4=65537$$

¹ It should be noted that 2, 8, 128 and 32768 can be obtained as iteration results only through iterations of the type $\phi(\dots(Z(\phi(n))))\dots$ whereas the "complete" iterations $Z(\dots(\phi(Z(\phi(n))))\dots)$ lead to the invariants 3, 15, 255, 65535. Consequently we note that for example $Z(\phi(8)) = 7$ not 15, i.e. 8 does not belong to its own cycle.

while $F_5=641\cdot 6700417$ as well as $F_6, F_7, F_8, F_9, F_{10}$ and F_{11} are all known to be composite.

From this we see that

$$\phi(2^{2^r} - 1) = \phi(q(r)) = \phi(F_0) \phi(F_1) \dots \phi(F_{r-1}) = 2 \cdot 2^2 \cdot \dots \cdot 2^{2^{r-1}} = 2^{1+2+2^2+\dots+2^{r-1}} = 2^{2^r-1} \quad (3)$$

for $r=1, 2, 3, 4, 5$ but breaks down for $r=6$ (because F_5 is composite) and consequently also for $r>6$.

Evaluating (3) for $r=1,2,3,4,5$ gives the complete table of expressions for the five 2-cycles.

Cycle #	2-cycle	Equivalent expression
1	2 ↔ 3	$2 \leftrightarrow 2^2-1$
2	8 ↔ 15	$2^3 \leftrightarrow 2^4-1$
3	128 ↔ 255	$2^7 \leftrightarrow 2^8-1$
4	32768 ↔ 65535	$2^{15} \leftrightarrow 2^{16}-1$
5	2147483648 ↔ 4294967295	$2^{31} \leftrightarrow 2^{32}-1$

The answers to the two questions are implicit in the above theorem.

- 1) The $Z-\phi$ sequence always reduces to a 2-cycle of the form $2^{2^r-1} \leftrightarrow 2^{2^r} - 1$ for $r \geq 1$.
- 2) Only five patterns exist and they always appear first for $n = 2^{2^r} - 1, r=1,2,3,4,5$.

A statistical survey of the frequency of the different 2-cycles, displayed in table 2, indicates that the lower cycles are favored when the initiating numbers grow larger. Cycle #4 could have appeared in the third interval but as can be seen it is generally scarcely represented. Prohibitive computer execution times made it impossible to systematically examine an interval were cycle #5 members can be assumed to exist. However, apart from the "founding member" $2147483648 \leftrightarrow 4294967295$ a few individual members were calculated by solving the equation:

$$Z(\phi(n))=2^{32}-1$$

The result is shown in table 3.

Table 2. The distribution of cycles for a few intervals of length 1000.

Interval	Cycle #1	Cycle #2	Cycle #3	Cycle #4
$3 \leq n \leq 1002$	572	358	70	-
$10001 \leq n \leq 11000$	651	159	190	-
$100001 \leq n \leq 101000$	759	100	141	0
$1000001 \leq n \leq 1001000$	822	75	86	17
$10000001 \leq n \leq 100001000$	831	42	64	63
$100000001 \leq n \leq 1000001000$	812	52	43	93

Table 3. A few members of the cycle #5 family.

n	$\phi(n)$	$Z(\phi(n))$	$\phi(Z(\phi(n)))$
38655885321	25770196992	4294967295	2147483648
107377459225	85900656640	4294967295	2147483648
966397133025	515403939840	4294967295	2147483648
1241283428641	1168248930304	4294967295	2147483648
11171550857769	7009493581824	4294967295	2147483648
31032085716025	23364978606080	4294967295	2147483648
279288771444225	140189871636480	4294967295	2147483648
283686952174081	282578800082944	4294967295	2147483648
2553182569566729	1695472800497664	4294967295	2147483648
7092173804352025	5651576001658880	4294967295	2147483648
63829564239168225	33909456009953280	4294967295	2147483648
81985529178309409	76861433622560768	4294967295	2147483648
2049638229457735225	1537228672451215360	4294967295	2147483648

References

1. H. Ibstedt, *Surfing on the Ocean of Numbers*, Erhus University Press, 1997.
2. Charles Ashbacher, *Pluckings From the Tree of Smarandache Sequences and Functions*, American Research Press, 1998.
3. Charles Ashbacher, On Iterations That Alternate the Pseudo-Smarandache and Classic Functions of Number Theory, *Smarandache Notions Journal*, Vol. 11, No 1-2-3.

7, Rue du Sergent Blandan
92130 Issy les Moulineaux, France

On the Pseudo-Smarandache Function and Iteration Problems

Part II: The Sum of Divisors Function

Henry Ibstedt

Abstract: This study is an extension of work done by Charles Ashbacher. Iteration results have been re-defined in terms of invariants and loops. Further empirical studies and analysis of results have helped throw light on a few intriguing questions.

I. Summary of a study by Charles Ashbacher [1]

The following definition forms the basis of Ashbacher's study: For $n > 1$, the Z-sigma sequence is the alternating iteration of the sigma, sum of divisors, function followed by the Pseudo-Smarandache function.

The Z-sigma sequence originated by n creates a cycle. Ashbacher identified four 2 cycles and one 12 cycle. These are listed in table 1.

Table 1. Iteration cycles $C_1 - C_5$.

n	C_k	Cycle
2	C_1	$3 \leftrightarrow 2$
$3 \leq n \leq 15$	C_2	$24 \leftrightarrow 15$
$n=16$	C_3	$31 \rightarrow 32 \rightarrow 63 \rightarrow 104 \rightarrow 64 \rightarrow 127 \rightarrow 126 \rightarrow 312 \rightarrow 143 \rightarrow 168 \rightarrow 48 \rightarrow 124$
$17 \leq n \leq 19$	C_2	$24 \leftrightarrow 15$
$n=20$	C_3	$42 \leftrightarrow 20$
$n=21$	C_3	$31 \rightarrow 32 \rightarrow 63 \rightarrow 104 \rightarrow 64 \rightarrow 127 \rightarrow 126 \rightarrow 312 \rightarrow 143 \rightarrow 168 \rightarrow 48 \rightarrow 124$
$22 \leq n \leq 24$	C_2	$24 \leftrightarrow 15$
$n=25$	C_3	$31 \rightarrow 32 \rightarrow 63 \rightarrow 104 \rightarrow 64 \rightarrow 127 \rightarrow 126 \rightarrow 312 \rightarrow 143 \rightarrow 168 \rightarrow 48 \rightarrow 124$
$n=26$	C_3	$42 \leftrightarrow 20$
...		
$n=381$	C_5	$1023 \leftrightarrow 1536$

The search for new cycles was continued up to $n=552,000$. No new ones were found. This lead Ashbacher to pose the following questions

- 1) Is there another cycle generated by the $Z\sigma$ sequence?
- 2) Is there an infinite number of numbers n that generate the two cycle $42 \leftrightarrow 20$?
- 3) Are there any other numbers n that generate the two cycle $2 \leftrightarrow 3$?
- 4) Is there a pattern to the first appearance of a new cycle?

Ashbacher concludes his article by stating that these problems have only been touched upon and encourages others to further explore these problems.

II. An extended study of the $Z\sigma$ iteration

It is amazing that hundred thousands of integers subject to a fairly simple iteration process all end up with final results that can be described by a few small integers. This merits a closer analysis. In an earlier study of iterations [2] the author classified iteration results in terms of invariants, loops and divergents. Applying the iteration to a member of a loop produces another member of the same loop. The cycles described in the previous section are not loops. The members of a cycle are not generated by the same process, half of them are generated by $Z(\sigma(Z(\dots\sigma(n)\dots)))$ while the other half is generated by $(\sigma(Z(\dots\sigma(n)\dots)))$, i.e. we are considering two different operators. This leads to a situation where the iteration process applied to a member of a cycle may generate a member of another cycle as described in table 2.

Table 2. A $Z\sigma$ iteration applied to an element belonging to one cycle may generate an element belonging to another cycle .

	C ₁		C ₂		C ₃		C ₄												C ₅	
n	2	3	15	24	20	42	31	32	63	104	64	127	126	312	143	168	48	124	1023	1536
$\sigma(n)$	3	4	24	60	42	96	32	63	104	210	127	128	312	840	168	480	124	224	1536	4092
$Z(\sigma(n))$	2	7	15	15	20	63	63	27	64	20	126	255	143	224	48	255	31	63	1023	495
$\sigma(Z(\sigma(n)))$	8						40				...		504		...				936	
$Z(\sigma(Z(\sigma(n))))$	15						15				15		63		15				143	
...																				
Generates	C ₁	C ₂	C ₂	C ₂	C ₃	C ₄	C ₄	C ₂	C ₄	C ₃	C ₄	C ₂	C ₄	C ₄	C ₄	C ₂	C ₄	C ₄	C ₅	C ₄
*=Shift to other cycle		*				*		*		*		*				*				*

This situation makes it impossible to establish a one-to-one correspondence between a number n to which the sequence of iterations is applied and the cycle that it will generate. Henceforth the iteration function will be $Z(\sigma(n))$ which will be denoted $Z\sigma(n)$ while results included in the above cycles originating from $\sigma(Z(\dots\sigma(n)\dots))$ will be considered as intermediate elements. This leads to an unambiguous situation which is shown in table 3.

Table3. The $Z\sigma$ iteration process described in terms of invariants, loops and intermediate elements.

	I ₁	I ₂	I ₃	Loop						I ₄
n	2	15	20	31	63	64	126	143	48	1023
$Z(\sigma(n))$	2	15	20	63	64	126	143	48	31	1023
Intermediate element	3	24	42	32	104	127	312	168	124	1536

We have four invariants I_1, I_2, I_3 and I_4 and one loop L with six elements. No other invariants or loops exist for $n \leq 10^6$. Each number $n \leq 10^6$ corresponds to one of the invariants or the loop. The distribution of results of the $Z\sigma$ iteration has been examined by intervals of size 50000 as shown in table 4. The stability of this distribution is amazing. It deserves a closer look and will help bringing us closer to answers to the four questions posed by Ashbacher.

Question number 3: Are there any other numbers n that generate the two cycle $2 \leftrightarrow 3$? In the framework set for this study this question will reformulated to: Are there any other numbers than $n=2$ that belongs to the invariant 2?

Theorem: $n=2$ is the only element for which $Z(\sigma(n))=2$.

Proof:

$Z(x)=2$ has only one solution which is $x=3$. $Z(\sigma(n))=2$ can therefore only occur when $\sigma(n)=3$ which has the unique solution $n=2$.

□

Table 4. $Z\sigma$ iteration iteration results.

Interval	I_2	I_3	Loop	I_4
3-50000	18824	236	29757	1181
50001-100000	18255	57	30219	1469
100001-150000	17985	49	30307	1659
150001-200000	18129	27	30090	1754
200001-250000	18109	38	30102	1751
250001-300000	18319	33	29730	1918
300001-350000	18207	24	29834	1935
350001-400000	18378	18	29622	1982
400001-450000	18279	21	29645	2055
450001-500000	18182	24	29716	2078
500001-550000	18593	18	29227	2162
550001-600000	18159	19	29651	2171
600001-650000	18596	25	29216	2163
650001-700000	18424	26	29396	2154
700001-750000	18401	20	29409	2170
750001-800000	18391	31	29423	2155
800001-850000	18348	22	29419	2211
850001-900000	18326	15	29338	2321
900001-950000	18271	24	29444	2261
950001-1000000	18517	31	29257	2195
Average	18335	38	29640	1987

Question number 2: Is there an infinite number of numbers n that generate the two cycle $42 \leftrightarrow 20$?

Conjecture: There are infinitely many numbers n which generate the invariant 20 (I_3).

Support:

Although the statistics shown in table 4 only skims the surface of the “ocean of numbers” the number of numbers generating this invariant is as stable as for the other invariants and the loop. To this is added the fact that any number $>10^6$ will either generate a new invariant or loop (highly unlikely) or “catch on to” one of the already existing end results where I_4 will get its share as the iteration “filters through” from 10^6 until it gets locked onto one of the established invariants or the loop.

□

Question number 1: Is there another cycle generated by the $Z\sigma$ sequence?

Discussion:

The search up to $n=10^6$ revealed no new invariants or loops. If another invariant or loop exists it must be initiated by $n>10^6$.

Let N be the value of n up to which the search has been completed. For $n=N+1$ there are three possibilities:

Possibility 1.

$Z(\sigma(n)) \leq N$. In this case continued iteration repeats iterations which have already been done in the complete search up to $n=N$. No new loops or invariants will be found.

Possibility 2.

$Z(\sigma(n)) = n$. If this happens then $n=N+1$ is a new invariant. A necessary condition for an invariant is therefore that

$$\frac{n(n+1)}{2\sigma(n)} = q, \text{ where } q \text{ is positive integer.} \quad (1)$$

If in addition no $m < n$ exists so that

$$\frac{m(m+1)}{2\sigma(n)} = q_1, \quad q_1 \text{ integer, then } n \text{ is invariant.} \quad (2)$$

There are 111 potential invariant candidates for n up to $3 \cdot 10^8$ satisfying the necessary condition (1). Only four of them $n = 2, 15, 20$ and 1023 satisfied condition (2). It seems that for a given solution to (1) there is always, for $n > N > 1023$, a solution to (2) with $m < n$. This is plausible since we know [4] that $\sigma(n) = O(n^{1+\delta})$ for every positive δ which means that $\sigma(n)$ is small compared to $n(n+1) \approx n^2$ for large n .

Example: The largest $n < 3 \cdot 10^8$ for which (1) is satisfied is $n = 292,409,999$ with $\sigma(292,409,999) = 341,145,000$ and $292,409,999 \cdot 292,410,000 / (2 \cdot 341,145,000) = 125,318,571$. But $m = 613,700,000 < n$ exists for which $613,700,000 \cdot 613,700,001 / (2 \cdot 341,145,000) = 552,005,3$, an integer, which means that n is not invariant.

Possibility 3.

$Z(\sigma(n)) > N$. This could lead to a new loop or invariant. Let's suppose that a new loop of length $k \geq 2$ is created. All elements of this loop must be greater than N otherwise the iteration sequence will fall below N and end up on a previously known invariant or loop. A necessary condition for a loop is therefore that

$$Z(\sigma(n)) > n \text{ and } Z(\sigma(Z(\sigma(n)))) \geq n. \quad (3)$$

Denoting the k^{th} iteration $(Z\sigma)_k(n)$ we must finally have

$$(Z\sigma)_k(n) = (Z\sigma)_j(n) \text{ for some } k \neq j, \text{ interpreting } (Z\sigma)_0(n) = n \quad (4)$$

There isn't much hope for all this to happen since, for large n , already $Z(\sigma(n)) > n$ is a scarce event and becomes scarcer as we increase n . A study of the number of incidents where $(Z\sigma)_3(n) > n$ for $n < 800,000$ was made. There are only 86 of them, of these 65 occurred for $n < 100,000$. From $n = 510,322$ to $n = 800,000$ there was not a single incident.

Question number 4: No particular patterns were found.

Epilog:

In empirical studies of numbers the search for patterns and general behaviors is an interesting and important part. In this iteration study it is amazing that all these

numbers, where not even the sky is the limit¹, after a few iterations filter down to end up on one of three invariants or a single loop. The other amazing thing is the relative stability of distribution between the three invariants and the loop with increasing n (see table 4). When $(Z\sigma)_k(n)$ drops below n it catches on to an integer which has already been iterated and which has therefore already been classified to belong to one of the four terminal events. This in my mind explains the relative stability. In general the end result is obtained after only a few iterations. It is interesting to see that $\sigma(n)$ often assumes the same value for values of n which are fairly close together. Here is an example: $\sigma(n)=3024$ for $n=1020, 1056, 1120, 1230, 1284, 1326, 1420, 1430, 1484, 1504, 1506, 1564, 1670, 1724, 1826, 1846, 1886, 2067, 2091, 2255, 2431, 2515, 2761, 2839, 2911, 3023$. I may not have brought this subject much further but I hope to have contributed some light reading in the area of recreational mathematics.

References

1. H. Ibstedt, *Surfing on the Ocean of Numbers*, Erhus University Press, 1997.
2. Charles Ashbacher, *Pluckings From the Tree of Smarandache Sequences and Functions*, American Research Press, 1998.
3. Charles Ashbacher, On Iterations That Alternate the Pseudo-Smarandache and Classic Functions of Number Theory, *Smarandache Notions Journal*, Vol. 11, No 1-2-3.
4. G.H. Hardy and E.M. Wright, *An Introduction to the Theory of Numbers*. Oxford University Press, 1938.

7, Rue du Sergent Blandan
92130 Issy les Moulineaux, France

¹ "Not even the sky is the limit" expresses the same dilemma as the title of the author's book "Surfing on the ocean of numbers". Even with for ever faster computers and better software for handling large numbers empirical studies remain very limited.

ERDÖS-SMARANDACHE MOMENTS NUMBERS

Sabin Tabirca

Transilvania University of Brasov, Computer Science Department

The starting point of this article is represented by a recent work of Finch [2000]. Based on two asymptotic results concerning the Erdos function, he proposed some interesting equation concerning the moments of the Smarandache function. The aim of this note is give a bit modified proof and to show some computation results for one of the Finch equation. We will call the numbers obtained from computation '*Erdos-Smarandache Moments Number*'. The Erdos-Smarandache moment number of order 1 is obtained to be the Golomb-Dickman constant.

1. INTRODUCTION

We briefly present the results used in this article. These concern the relationship between the Smarandache and the Erdos functions and some asymptotic equations concerning them. These are important functions in Number Theory defined as follows:

- The Smarandache function [Smarandache, 1980] is $S: N^* \rightarrow N$,

$$S(n) = \min\{k \in N \mid k! \leq n\} \quad (\forall n \in N^*) \quad (1)$$

- The Erdos function is $P: N^* \rightarrow N$,

$$P(n) = \min\{p \in N \mid n \leq p \wedge p \text{ is prim}\} \quad (\forall n \in N^* \setminus \{1\}), \quad P(1) = 0. \quad (2)$$

Their main properties are:

$$(\forall a, b \in N^*) \quad (a, b) = 1 \Rightarrow S(a \cdot b) = \max\{S(a), S(b)\}, \quad P(a \cdot b) = \max\{P(a), P(b)\}. \quad (3)$$

$$(\forall a \in N^*) \quad P(a) \leq S(a) \leq a \quad \text{and the equalities occur iff } a \text{ is prim.} \quad (4)$$

An important equation between these functions was found by Erdos [1991]

$$\lim_{n \rightarrow \infty} \frac{\left| \left\{ i = \overline{1, n} \mid P(i) < S(i) \right\} \right|}{n} = 0, \quad (5)$$

which was extended by Ford [1999] to

$$\left| \left\{ i = \overline{1, n} \mid P(i) < S(i) \right\} \right| = n \cdot e^{-\left(\sqrt{2+a_n}\right)\sqrt{\ln n \cdot \ln \ln n}}, \quad \text{where } \lim_{n \rightarrow \infty} a_n = 0. \quad (6)$$

Equations (5-6) are very important because create a similarity between these functions especially for asymptotic properties. Moreover, these equations allow us to translate convergence properties

on the Smarandache function to convergence properties on the Erdos function and vice versa. The main important equations that have been obtained by this translation are presented in the following.

THE AVERAGE VALUES

$$\frac{1}{n} \sum_{i=2}^n S(i) = O\left(\frac{n}{\log n}\right) \text{ [Luca, 1999]} \quad \frac{1}{n} \sum_{i=2}^n P(i) = O\left(\frac{n}{\log n}\right) \text{ [Tabirca, 1999]} \text{ and their}$$

generalizations

$$\frac{1}{n} \sum_{i=2}^n P^a(i) = \frac{\zeta(a+1)}{a+1} \cdot \frac{n^a}{\ln(n)} + O\left(\frac{n^a}{\ln^2(n)}\right) \text{ [Knuth and Pardo 1976]}$$

$$\frac{1}{n} \sum_{i=2}^n S^a(i) = \frac{\zeta(a+1)}{a+1} \cdot \frac{n^a}{\ln(n)} + O\left(\frac{n^a}{\ln^2(n)}\right) \text{ [Finch, 2000]}$$

THE HARMONIC SERIES

$$\lim_{n \rightarrow \infty} \sum_{i=2}^n \frac{1}{S^a(i)} = \infty \text{ [Luca, 1999]} \quad \lim_{n \rightarrow \infty} \sum_{i=2}^n \frac{1}{P^a(i)} = \infty \text{ [Tabirca, 1999]}$$

THE LOG-AVERAGE VALUES

$$\lim_{n \rightarrow \infty} \frac{1}{n} \sum_{i=2}^n \frac{\ln P(i)}{\ln i} = \lambda \text{ [Kastanas, 1994]} \quad \lim_{n \rightarrow \infty} \frac{1}{n} \sum_{i=2}^n \frac{\ln S(i)}{\ln i} = \lambda \text{ [Finch, 1999]} \text{ and their}$$

generalizations

$$\lim_{n \rightarrow \infty} \frac{1}{n} \sum_{i=2}^n \left(\frac{\ln P(i)}{\ln i}\right)^a = \lambda_a \text{ [Shepp, 1964]} \quad \lim_{n \rightarrow \infty} \frac{1}{n} \sum_{i=2}^n \left(\frac{\ln S(i)}{\ln i}\right)^a = \lambda_a \text{ [Finch, 2000].}$$

2. THE ERDOS-SMARANDACHE MOMENT NUMBERS

From a combinatorial study of random permutation Shepp and Lloyd [1964] found the following integral equation

$$\lim_{n \rightarrow \infty} \frac{1}{n} \sum_{i=2}^n \left(\frac{\ln P(i)}{\ln i}\right)^a = \int_0^{\infty} \frac{x^{a-1}}{a!} \cdot \exp\left(-x - \int_{-x}^{\infty} \frac{\exp(-y)}{y} dy\right) dx := \lambda_a. \quad (7)$$

Finch [2000] started from Equation (7) and translated it from the Smarandache function.

Theorem [Finch, 2000] *If a is a positive number then*

$$\lim_{n \rightarrow \infty} \frac{1}{n} \sum_{i=2}^n \left(\frac{\ln S(i)}{\ln i}\right)^a = \lambda_a. \quad (8)$$

Proof

Many terms of the difference $\frac{1}{n} \sum_{i=2}^n \left(\frac{\ln S(i)}{\ln i} \right)^a - \frac{1}{n} \sum_{i=2}^n \left(\frac{\ln P(i)}{\ln i} \right)^a$ are equal, therefore there will be reduced. This difference is transformed as follows:

$$\begin{aligned} & \left| \frac{1}{n} \sum_{i=2}^n \left(\frac{\ln S(i)}{\ln i} \right)^a - \frac{1}{n} \sum_{i=2}^n \left(\frac{\ln P(i)}{\ln i} \right)^a \right| = \frac{1}{n} \cdot \left| \sum_{i=2}^n \left[\left(\frac{\ln S(i)}{\ln i} \right)^a - \left(\frac{\ln P(i)}{\ln i} \right)^a \right] \right| = \\ & = \frac{1}{n} \cdot \left| \sum_{i: S(i) > P(i)} \left[\left(\frac{\ln S(i)}{\ln i} \right)^a - \left(\frac{\ln P(i)}{\ln i} \right)^a \right] \right| \leq \frac{1}{n} \cdot \sum_{i: S(i) > P(i)} \frac{|\ln^a S(i) - \ln^a P(i)|}{\ln^a i} \leq \\ & \leq \frac{1}{n} \cdot \sum_{i: S(i) > P(i)} \frac{|\ln^a S(i) - \ln^a P(i)|}{\ln^a i} \leq \frac{1}{n}. \end{aligned}$$

In the following we will present a proof for the result The Erdos harmonic series can be defined

by $\sum_{n \geq 2} \frac{1}{P^a(n)}$. This is one of the important series with the Erdos function and its convergence

is studied starting from the convergence of the Smarandache harmonic series $\sum_{n \geq 2} \frac{1}{S^a(n)}$. Some

results concerning series with the function S are reviewed briefly in the following:

- If $(x_n)_{n > 0}$ is an increasing sequence such that $\lim_{n \rightarrow \infty} x_n = \infty$, then the series $\sum_{n > 1} \frac{x_{n+1} - x_n}{S(x_n)}$ is divergent. [Cojocaru, 1997]. (7)
- The series $\sum_{n \geq 2} \frac{1}{S^2(n)}$ is divergent. [Tabirca, 1998] (8)
- The series $\sum_{n \geq 2} \frac{1}{S^a(n)}$ is divergent for all $a > 0$. [Luca, 1999] (9)

These above results are translated to the similar properties on the Erdos function.

Theorem 1. If $(x_n)_{n > 0}$ is an increasing sequence such that $\lim_{n \rightarrow \infty} x_n = \infty$, then the series

$$\sum_{n > 1} \frac{x_{n+1} - x_n}{P(x_n)}$$

is divergent.

Proof The proof is obvious based on the equation $P(x_n) \leq S(x_n)$. Therefore, the equation

$$\frac{x_{n+1} - x_n}{P(x_n)} \geq \frac{x_{n+1} - x_n}{S(x_n)} \text{ and the divergence of the series } \sum_{n>1} \frac{x_{n+1} - x_n}{S(x_n)} \text{ give that the series}$$

$$\sum_{n>1} \frac{x_{n+1} - x_n}{P(x_n)} \text{ is divergent.} \quad \blacklozenge$$

A direct consequence of Theorem 1 is the divergence of the series $\sum_{n>1} \frac{1}{P(a \cdot n + b)}$, where $a, b > 0$

are positive numbers. This gives that $\sum_{n \geq 2} \frac{1}{P(n)}$ is divergent and moreover that $\sum_{n \geq 2} \frac{1}{P^a(n)}$ is

divergent for all $a < 1$.

Theorem 2. The series $\sum_{n \geq 2} \frac{1}{P^a(n)}$ is divergent for all $a > 1$.

Proof The proof studies two cases.

Case 1. $a \geq \frac{1}{2}$.

In this case, the proof is made by using the divergence of $\sum_{n \geq 2} \frac{1}{S^a(n)}$.

Denote $A = \{i = \overline{2, n} \mid S(i) = P(i)\}$ and $B = \{i = \overline{2, n} \mid S(i) > P(i)\}$ a partition of the set $\{i = \overline{1, n}\}$. We start from the following simple transformation

$$\sum_{i=2}^n \frac{1}{P^a(i)} = \sum_{i=2}^n \frac{1}{S^a(i)} + \sum_{i \in B} \left[\frac{1}{P^a(i)} - \frac{1}{S^a(i)} \right] = \sum_{i=2}^n \frac{1}{S^a(i)} + \sum_{i \in B} \frac{S^a(i) - P^a(i)}{P^a(i) \cdot S^a(i)}. \quad (10)$$

An $i \in B$ satisfies $S^a(i) - P^a(i) \geq 1$ and $P(i) < S(i) \leq n$ thus, (10) becomes

$$\sum_{i=2}^n \frac{1}{P^a(i)} \geq \sum_{i=2}^n \frac{1}{S^a(i)} + \sum_{i \in B} \frac{1}{n^{2a}} = \sum_{i=2}^n \frac{1}{S^a(i)} + \frac{1}{n^{2a}} \cdot |B|. \quad (11)$$

The series $\sum_{n \geq 2} \frac{1}{P^a(n)}$ is divergent because the series $\sum_{n \geq 2} \frac{1}{S^a(n)}$ is divergent and

$$\lim_{n \rightarrow \infty} \frac{|B|}{n^{2a}} = \lim_{n \rightarrow \infty} \frac{n \cdot e^{-(\sqrt{2+a_n}) \cdot \sqrt{\ln n \cdot \ln \ln n}}}{n^{2a}} = \lim_{n \rightarrow \infty} \frac{1}{n^{2a-1} \cdot e^{(\sqrt{2+a_n}) \cdot \sqrt{\ln n \cdot \ln \ln n}}} = 0.$$

Case 2. $\frac{1}{2} > a > 1$.

The first case gives that the series $\sum_{n \geq 2} \frac{1}{P^{\frac{1}{2}}(n)}$ is divergent.

Based on $P^{\frac{1}{2}}(n) > P^a(n)$, the inequality $\sum_{i=2}^n \frac{1}{P^a(i)} > \sum_{i=2}^n \frac{1}{P^{\frac{1}{2}}(i)}$ is found. Thus, the series

$\sum_{n \geq 2} \frac{1}{S^a(n)}$ is divergent. ♦

The technique that has been applied to the proof of Theorem 2 can be used in the both ways. Theorem 2 started from a property of the Smarandache function and found a property of the

Erdos function. Opposite, Finch [1999] found the property $\lim_{n \rightarrow \infty} \frac{\sum_{i=2}^n \frac{\ln S(i)}{\ln i}}{n} = \lambda$ based on the

similar property $\lim_{n \rightarrow \infty} \frac{\sum_{i=2}^n \frac{\ln P(i)}{\ln i}}{n} = \lambda$, where $\lambda=0.6243299$ is the Golomb-Dickman constant.

Obviously, many other properties can be proved using this technique. Moreover, Equations (5-6) gives a very interesting fact - "the Smarandache and Erdos function may have the same behavior especially on the convergence problems."

References

- Cojocaru, I. And Cojocaru, S. (1997) On a function in Number Theory, *Smarandache Notions Journal*, **8**, No. 1-2-3, 164-169
- Erdos, P. (1991) *Problem 6674*, Amer. Math. Monthly. **98**, 965.
- Ford, K. (1999) The normal behaviours of the Smarandache function, *Smarandache Notions Journal*, Vol. **10**, No.1-2-3, 81-86.
- Luca, F. (1999) On the divergence of the Smarandache harmonic series, *Smarandache Notions Journal*, **10**, No. 1-2-3, 116-118.
- Tabirca, S. and Tabirca, T. (1998) The convergence of the Smarandache harmonic series, *Smarandache Notions Journal*, **9**, No. 1-2, 27-35.
- Smarandache, F. (1980) A Function in number theory, *Analele Univ. Timisoara*, **XVIII**.

ERDÖS-SMARANDACHE NUMBERS

Sabin Tabirca*

Tatiana Tabirca**

*Transilvania University of Brasov, Computer Science Department

**University of Manchester, Computer Science Department

The starting point of this article is represented by a recent work of Finch [2000]. Based on two asymptotic results concerning the Erdos function, he proposed some interesting equations concerning the moments of the Smarandache function. The aim of this note is give a bit modified proof and to show some computation results for one of the Finch equation. We will call the numbers obtained from computation '*the Erdos-Smarandache Numbers*'. The Erdos-Smarandache number of order 1 is obtained to be the Golomb-Dickman constant.

1. INTRODUCTION

We briefly present the results used in this article. These concern the relationship between the Smarandache and the Erdos functions and some asymptotic equations concerning them. The Smarandache and Erdos functions are important functions in Number Theory defined as follows:

- The Smarandache function [Smarandache, 1980] is $S: N^* \rightarrow N$,

$$S(n) = \min\{k \in N \mid k! \times n\} \quad (\forall n \in N^*). \quad (1)$$

- The Erdos function is $P: N^* \rightarrow N$,

$$P(n) = \min\{p \in N \mid n \times p \wedge p \text{ is prim}\} \quad (\forall n \in N^* \setminus \{1\}), \quad P(1) = 0. \quad (2)$$

Their main properties are:

$$(\forall a, b \in N^*) \quad (a, b) = 1 \Rightarrow S(a \cdot b) = \max\{S(a), S(b)\}, \quad P(a \cdot b) = \max\{P(a), P(b)\}. \quad (3)$$

$$(\forall a \in N^*) \quad P(a) \leq S(a) \leq a \quad \text{and the equalities occur iff } a \text{ is prim.} \quad (4)$$

An important equation between these functions was found by Erdos [1991]

$$\lim_{n \rightarrow \infty} \frac{\left| \left\{ i = \overline{1, n} \mid P(i) < S(i) \right\} \right|}{n} = 0, \quad (5)$$

which was extended by Ford [1999] to

$$\left| \left\{ i = \overline{1, n} \mid P(i) < S(i) \right\} \right| = n \cdot e^{-(\sqrt{2+a_n})\sqrt{\ln n \cdot \ln \ln n}}, \quad \text{where } \lim_{n \rightarrow \infty} a_n = 0. \quad (6)$$

Equations (5-6) are very important because create a similarity between these functions especially for asymptotic properties. Moreover, these equations allow us to translate convergence properties of the Smarandache function to convergence properties on the Erdos function and vice versa. The main important equations that have been obtained using this translation are presented in the following.

The average values

$$\frac{1}{n} \sum_{i=2}^n S(i) = O\left(\frac{n}{\log n}\right) \text{ [Luca, 1999]}, \quad \frac{1}{n} \sum_{i=2}^n P(i) = O\left(\frac{n}{\log n}\right) \text{ [Tabirca, 1999a]}$$

and their generalizations

$$\frac{1}{n} \sum_{i=2}^n P^a(i) = \frac{\zeta(a+1)}{a+1} \cdot \frac{n^a}{\ln(n)} + O\left(\frac{n^a}{\ln^2(n)}\right) \text{ [Knuth and Pardo 1976]}$$

$$\frac{1}{n} \sum_{i=2}^n S^a(i) = \frac{\zeta(a+1)}{a+1} \cdot \frac{n^a}{\ln(n)} + O\left(\frac{n^a}{\ln^2(n)}\right) \text{ [Finch, 2000]}$$

The log-average values

$$\lim_{n \rightarrow \infty} \frac{1}{n} \sum_{i=2}^n \frac{\ln P(i)}{\ln i} = \lambda \text{ [see Finch, 1999]} \quad \lim_{n \rightarrow \infty} \frac{1}{n} \sum_{i=2}^n \frac{\ln S(i)}{\ln i} = \lambda \text{ [Finch, 1999]}$$

and their generalizations

$$\lim_{n \rightarrow \infty} \frac{1}{n} \sum_{i=2}^n \left(\frac{\ln P(i)}{\ln i}\right)^a = \lambda_a \text{ [Shepp, 1964]} \quad \lim_{n \rightarrow \infty} \frac{1}{n} \sum_{i=2}^n \left(\frac{\ln S(i)}{\ln i}\right)^a = \lambda_a \text{ [Finch, 2000].}$$

The Harmonic Series

$$\lim_{n \rightarrow \infty} \sum_{i=2}^n \frac{1}{S^a(i)} = \infty \text{ [Luca, 1999], [Tabirca, 1998]} \quad \lim_{n \rightarrow \infty} \sum_{i=2}^n \frac{1}{P^a(i)} = \infty \text{ [Tabirca, 1999]}$$

2. THE ERDOS-SMARANDACHE NUMBERS

From a combinatorial study of random permutation Sheep and Lloyd [1964] found the following integral equation

$$\lim_{n \rightarrow \infty} \frac{1}{n} \sum_{i=2}^n \left(\frac{\ln P(i)}{\ln i}\right)^a = \int_0^{\infty} \frac{x^{a-1}}{a!} \cdot \exp\left(-x - \int_{-x}^{\infty} \frac{\exp(-y)}{y} dy\right) dx := \lambda_a. \quad (7)$$

Finch [2000] started from Equation (7) and translated it from the Smarandache function.

Theorem [Finch, 2000] *If a is a positive integer number then*

$$\lim_{n \rightarrow \infty} \frac{1}{n} \sum_{i=2}^n \left(\frac{\ln S(i)}{\ln i} \right)^a = \lim_{n \rightarrow \infty} \frac{1}{n} \sum_{i=2}^n \left(\frac{\ln P(i)}{\ln i} \right)^a. \quad (8)$$

Proof

Many terms of the difference $\frac{1}{n} \sum_{i=2}^n \left(\frac{\ln S(i)}{\ln i} \right)^a - \frac{1}{n} \sum_{i=2}^n \left(\frac{\ln P(i)}{\ln i} \right)^a$ are equal, therefore there will be reduced. This difference is transformed as follows:

$$\begin{aligned} & \left| \frac{1}{n} \sum_{i=2}^n \left(\frac{\ln S(i)}{\ln i} \right)^a - \frac{1}{n} \sum_{i=2}^n \left(\frac{\ln P(i)}{\ln i} \right)^a \right| = \frac{1}{n} \cdot \left| \sum_{i=2}^n \left[\left(\frac{\ln S(i)}{\ln i} \right)^a - \left(\frac{\ln P(i)}{\ln i} \right)^a \right] \right| = \\ & = \frac{1}{n} \cdot \left| \sum_{i: S(i) > P(i)} \left[\left(\frac{\ln S(i)}{\ln i} \right)^a - \left(\frac{\ln P(i)}{\ln i} \right)^a \right] \right| \leq \frac{1}{n} \cdot \sum_{i: S(i) > P(i)} \frac{|\ln^a S(i) - \ln^a P(i)|}{\ln^a i}. \end{aligned}$$

The general term of the last sum is superiorly bounded by

$$\frac{|\ln^a S(i) - \ln^a P(i)|}{\ln^a i} \leq \ln^a n$$

because $|\ln^a S(i) - \ln^a P(i)| = \ln^a S(i) - \ln^a P(i) \leq \ln^a n$ and $\ln^a i > 1$ ($i > 3$).

Therefore, the chain of inequalities is continued as follows:

$$\begin{aligned} & \left| \frac{1}{n} \sum_{i=2}^n \left(\frac{\ln S(i)}{\ln i} \right)^a - \frac{1}{n} \sum_{i=2}^n \left(\frac{\ln P(i)}{\ln i} \right)^a \right| \leq \frac{1}{n} \cdot \ln^a n \cdot |i = \overline{1, n}: S(i) > P(i)| = \\ & = \frac{1}{n} \cdot \ln^a n \cdot n \cdot e^{-(\sqrt{2}+a_n)\sqrt{\ln n \cdot \ln \ln n}} = \frac{\ln^a n}{e^{(\sqrt{2}+a_n)\sqrt{\ln n \cdot \ln \ln n}}}. \end{aligned}$$

In order to prove that last right member tends to 0, we start from $\lim_{x \rightarrow \infty} \frac{x^{2a}}{e^x} = 0$. We substitute

$x = \sqrt{\ln n \cdot \ln \ln n} \rightarrow \infty$ and the limit becomes $\lim_{n \rightarrow \infty} \frac{(\ln n \cdot \ln \ln n)^a}{e^{\sqrt{\ln n \cdot \ln \ln n}}} = 0$. Now, the last right

member is calculated as follows:

$$\lim_{n \rightarrow \infty} \frac{\ln^a n}{e^{(\sqrt{2}+a_n)\sqrt{\ln n \cdot \ln \ln n}}} = \lim_{n \rightarrow \infty} \frac{(\ln n \cdot \ln \ln n)^a}{e^{\sqrt{\ln n \cdot \ln \ln n}}} \cdot \frac{1}{(\ln \ln n)^a} \cdot \frac{1}{e^{(\sqrt{2}-1+a_n)\sqrt{\ln n \cdot \ln \ln n}}} = 0.$$

Therefore, the equation $\lim_{n \rightarrow \infty} \frac{1}{n} \sum_{i=2}^n \left(\frac{\ln S(i)}{\ln i} \right)^a = \lim_{n \rightarrow \infty} \frac{1}{n} \sum_{i=2}^n \left(\frac{\ln P(i)}{\ln i} \right)^a$ holds. \clubsuit

The essence of this proof and the proof from [Finch, 2000] is given by Equation (6). But the above proof is a bit general giving even more

$$\lim_{n \rightarrow \infty} (\ln \ln n)^a \cdot \left[\frac{1}{n} \sum_{i=2}^n \left(\frac{\ln S(i)}{\ln i} \right)^a - \frac{1}{n} \sum_{i=2}^n \left(\frac{\ln P(i)}{\ln i} \right)^a \right] = 0.$$

Definition. The Erdos-Smarandache number of order $a \in \mathbb{N}$ is defined by

$$\lambda_a = \lim_{n \rightarrow \infty} \frac{1}{n} \sum_{i=2}^n \left(\frac{\ln S(i)}{\ln i} \right)^a = \lim_{n \rightarrow \infty} \frac{1}{n} \sum_{i=2}^n \left(\frac{\ln P(i)}{\ln i} \right)^a.$$

Equation (7) gives a formula for this number $\lambda_a = \int_0^{\infty} \frac{x^{a-1}}{a!} \cdot \exp\left(-x - \int_{-x}^{\infty} \frac{\exp(-y)}{y} dy\right) dx$. For

$a=1$, we obtain that the Erdos-Smarandache number $\lambda_1 = \lim_{n \rightarrow \infty} \frac{1}{n} \sum_{i=2}^n \frac{\ln S(i)}{\ln i} = \lim_{n \rightarrow \infty} \frac{1}{n} \sum_{i=2}^n \frac{\ln P(i)}{\ln i}$,

is in fact the Golomb-Dickman constant. Using a simple Maple computation the values of the first 20 Erdos-Smarandache numbers have been calculated with 15 exact decimals. They are presented below.

$$a=1 \Rightarrow \lambda_1=0.624329988543551$$

$$a=11 \Rightarrow \lambda_{11}=0.0909016222187764$$

$$a=2 \Rightarrow \lambda_2=0.426695764659643$$

$$a=12 \Rightarrow \lambda_{12}=0.083330176072027$$

$$a=3 \Rightarrow \lambda_3=0.313630673224523$$

$$a=13 \Rightarrow \lambda_{13}=0.0769217248993612$$

$$a=4 \Rightarrow \lambda_4=0.243876608021201$$

$$a=14 \Rightarrow \lambda_{14}=0.0714279859927442$$

$$a=5 \Rightarrow \lambda_5=0.197922893443075$$

$$a=15 \Rightarrow \lambda_{15}=0.0666664107138031$$

$$a=6 \Rightarrow \lambda_6=0.16591855680276$$

$$a=16 \Rightarrow \lambda_{16}=0.0624998871487541$$

$$a=7 \Rightarrow \lambda_7=0.142575542115497$$

$$a=17 \Rightarrow \lambda_{17}=0.0588234792828849$$

$$a=8 \Rightarrow \lambda_8=0.124890340441877$$

$$a=18 \Rightarrow \lambda_{18}=0.0555555331402286$$

$$a=9 \Rightarrow \lambda_9=0.111067241922065$$

$$a=19 \Rightarrow \lambda_{19}=0.0526315688647356$$

$$a=10 \Rightarrow \lambda_{10}=0.0999820620134543$$

$$a=20 \Rightarrow \lambda_{20}=0.049999954405103$$

3. Final Remarks

The numbers provided by Equation (7) could have many other names such as the Golomb-Dickman generalized constants or Because they are implied in Equation (8), we believe that a proper name for them is the Erdos-Smarandache numbers. We should also say that it is the Finch major contribution in rediscovering a quite old equation and connecting it with the Smarandache function.

References

- Erdos, P. (1991) *Problem 6674*, Amer. Math. Monthly. **98**, 965.
- Ford, K. (1999) The normal behaviours of the Smarandache function, *Smarandache Notions Journal*, Vol. **10**, No.1-2-3, 81-86.
- Finch, S.R. (1999) The average of the Smarandache function, *Smarandache Notions Journal*, **10**, 95-96. available at <http://www.mathsoft.com/asolve/smarand/smarand.html>.
- Finch, S.R. (2000) Moments of the Smarandache function, [to be published in *Smarandache Notions Journal*], available at <http://www.mathsoft.com/asolve/smarand/smarand.html>.
- Knuth, D.E. and Pardo, L.T. (1976) Analysis of a simple factorisation algorithm, *Theoretical Computer Science*, **3**, 321-348.
- Luca, F. (1999) On the divergence of the Smarandache harmonic series, *Smarandache Notions Journal*, **10**, No. 1-2-3, 116-118.
- Luca, F. (1999) The average value of the Smarandache function, [*Personal communication to Sabin Tabirca*].
- Shepp, L.A. and Lloyd, S.P. (1966) Ordered cycle lengths in a random permutaion, *Trans. Amer. Math. Soc.*, **121**, 350-357.
- Tabirca, S. and Tabirca, T. (1998) The convergence of the Smarandache harmonic series, *Smarandache Notions Journal*, **9**, No. 1-2, 27-35.
- Tabirca, S. and Tabirca, T. (1999) The convergence of the Erdos harmonic series, *Smarandache Notions Journal*, **9**, No. 3-4-5.
- Tabirca, S. and Tabirca, T. (1999a) The average value of the Erdos function, *Smarandache Notions Journal*, **9**, No. 3-4-5.
- Smarandache, F. (1980) A Function in number theory, *Analele Univ. Timisoara*, **XVIII**.

On the Pseudo-Smarandache Function

J. Sándor
Babes-Bolyai University, 3400 Cluj-Napoca, Romania

Kashihara[2] defined the Pseudo-Smarandache function Z by

$$Z(n) = \min \left\{ m \geq 1 : n \mid \frac{m(m+1)}{2} \right\}$$

Properties of this function have been studied in [1], [2] etc.

1. By answering a question by C. Ashbacher, Maohua Le proved that $S(Z(n)) - Z(S(n))$ changes signs infinitely often. Put

$$\Delta_{s,z}(n) = |S(Z(n)) - Z(S(n))|$$

We will prove first that

$$\liminf_{n \rightarrow \infty} \Delta_{s,z}(n) \leq 1 \quad (1)$$

and

$$\limsup_{n \rightarrow \infty} \Delta_{s,z}(n) = +\infty \quad (2)$$

Indeed, let $n = \frac{p(p+1)}{2}$, where p is an odd prime. Then it is not difficult to see that

$S(n) = p$ and $Z(n) = p$. Therefore,

$$|S(Z(n)) - Z(S(n))| = |S(p) - S(p)| = |p - (p-1)| = 1$$

implying (1). We note that if the equation $S(Z(n)) = Z(S(n))$ has infinitely many solutions, then clearly the \liminf in (1) is 0, otherwise is 1, since

$$|S(Z(n)) - Z(S(n))| \geq 1,$$

$S(Z(n)) - Z(S(n))$ being an integer.

Now let $n = p$ be an odd prime. Then, since $Z(p) = p-1$, $S(p) = p$ and $S(p-1) \leq \frac{p-1}{2}$

(see [4]) we get

$$\Delta_{s,z}(p) = |S(p-1) - (p-1)| = p-1 - S(p-1) \geq \frac{p-1}{2} \rightarrow \infty \text{ as } p \rightarrow \infty$$

proving (2). Functions of type $\Delta_{f,g}$ have been studied recently by the author [5] (see also [3]).

2. Since $n \mid \frac{(2n-1)2n}{2}$, clearly $Z(n) \leq 2n-1$ for all n .

This inequality is best possible for even n , since $Z(2^k) = 2^{k+1} - 1$. We note that for odd n , we have $Z(n) \leq n - 1$, and this is best possible for odd n , since $Z(p) = p-1$ for prime p . By

$$\frac{Z(n)}{n} \leq 2 - \frac{1}{n} \text{ and } \frac{Z(2^k)}{2^k} = 2 - \frac{1}{2^k}$$

$$\text{we get } \limsup_{n \rightarrow \infty} \frac{Z(n)}{n} = 2. \quad (3)$$

Since $Z\left(\frac{p(p+1)}{2}\right) = p$, and $\frac{p}{p(p+1)/2} \rightarrow 0$ ($p \rightarrow \infty$), it follows

$$\liminf_{n \rightarrow \infty} \frac{Z(n)}{n} = 0 \quad (4)$$

For $Z(Z(n))$, the following can be proved. By

$$Z\left(Z\left(\frac{p(p+1)}{2}\right)\right) = p-1, \text{ clearly}$$

$$\liminf_{n \rightarrow \infty} \frac{Z(Z(n))}{n} = 0 \quad (5)$$

On the other hand, by $Z(Z(n)) \leq 2Z(n) - 1$ and (3), we have

$$\limsup_{n \rightarrow \infty} \frac{Z(Z(n))}{n} \leq 4 \quad (6)$$

3. We now prove

$$\liminf_{n \rightarrow \infty} |Z(2n) - Z(n)| = 0 \quad (7)$$

and

$$\limsup_{n \rightarrow \infty} |Z(2n) - Z(n)| = +\infty \quad (8)$$

Indeed, in [1] it was proved that $Z(2p) = p-1$ for a prime $p \equiv 1 \pmod{4}$. Since $Z(p) = p-1$, this proves relation (7).

On the other hand, let $n = 2^k$. Since $Z(2^k) = 2^{k+1} - 1$ and $Z(2^{k+1}) = 2^{k+2} - 1$, clearly $Z(2^{k+1}) - Z(2^k) = 2^{k+1} \rightarrow \infty$ as $k \rightarrow \infty$.

References

1. C. Ashbacher, *The Pseudo-Smarandache Function and the Classical Functions of Number Theory*, **Smarandache Notions J.**, 9(1998), No. 1-2, 78-81.
2. K. Kashihara, **Comments and Topics on Smarandache Notions and Problems**, Erhus Univ. Press, AZ., 1996.
3. M. Bencze, *OQ. 351*, **Octogon M.M.** 8(2000), No. 1, p. 275.
4. J. Sándor, *On Certain New Inequalities and Limits for the Smarandache Function*, **Smarandache Notions J.**, 9(1998), No. 1-2, 63-69.
5. J. Sándor, *On the Difference of Alternate Compositions of Arithmetical Functions*, to appear.

Smarandache k-k additive relationships

Henry Ibstedt

Abstract: An empirical study of Smarandache k-k additive relationships and related data is tabulated and analyzed. It leads to the conclusion that the number of Smarandache 2-2 additive relations is infinite. It is also shown that Smarandache k-k relations exist for large values of k.

We recall the definition of the Smarandache function $S(n)$:

Definition: $S(n)$ is the smallest integer such that $S(n)!$ is divisible by n .

The sequence of function values starts:

n:	1	2	3	4	5	6	7	8	9	10	...
S(n):	0	2	3	4	5	3	7	4	6	5	...

A table of values of $S(n)$ up to $n=4800$ is found in Vol. 2-3 of the Smarandache Function Journal [1].

Definition: A sequence of function values $S(n), S(n+1)+ \dots +S(n+2k-1)$ satisfies a k-k additive relationship if

$$S(n)+S(n+1)+ \dots +S(n+k-1)=S(n+k)+S(n+k+1)+ \dots +S(n+2k-1)$$

or

$$\sum_{j=0}^{k-1} S(n+j) = \sum_{j=k}^{2k-1} S(n+j)$$

A general definition of Smarandache p-q relationships is given by M. Bencze in Vol. 11 of the Smarandache Notions Journal [2]. Bencze gives the following examples of Smarandache 2-2 additive relationships: $S(n)+S(n+1)=S(n+2)+S(n+3)$

$$S(6)+S(7)=S(8)+S(9), 3+7=4+6;$$

$$S(7)+S(8)=S(9)+S(10), 7+4=6+5;$$

$$S(28)+S(29)=S(30)+S(31), 7+29=5+31.$$

He asks for others and questions whether there is a finite or infinite number of them. Actually the fourth one is quite far off:

$$S(114)+S(115)=S(116)+S(117), 19+23=29+13;$$

The fifth one is even further away:

$$S(1720)+S(1721)=S(1722)+S(1723), 43+1721=41+1723.$$

It is interesting to note that this solution is composed to two pairs of prime twins (1721,1723) and (43,41), - one ascending and one descending pair. This is also the case with the third solution found by Bencze.

One example of a Smarandache 3-3 additive relationship is given in the above mentioned article:

$$S(5)+S(6)+S(7)=S(8)+S(9)+S(10), 5+3+7=4+6+5.$$

Also in this case the next solution is far away:

$$S(5182)+S(5183)+S(5184)= S(5185)+S(5186)+S(5187), 2591+73+9=61+2593+19.$$

To throw some light on these types of relationships an online program for calculation of $S(n)$ [3] was used to tabulate Smarandache k - k additive relationships. Initially the following search limits were set: $n \leq 10^7$; $2 \leq k \leq 26$. For $k=2$ the search was extended to $n \leq 10^8$. The number of solutions m found in each case is given in table 1 and is displayed graphically in diagram 1 for $3 \leq k \leq 26$. The numerical results for $k \leq 6$ are presented in tables 4 -8.

Table 1. The number m of Smarandache k - k additive solutions for $n < 10^7$.

k	2	3	4	5	6	7	8	9	10	11	12	13	14	15	16	17	18	19	20	21	22	23	24	25	26
m	158	43	20	9	8	11	5	8	6	5	2	5	7	2	4	8	1	3	4	1	4	6	2	3	2

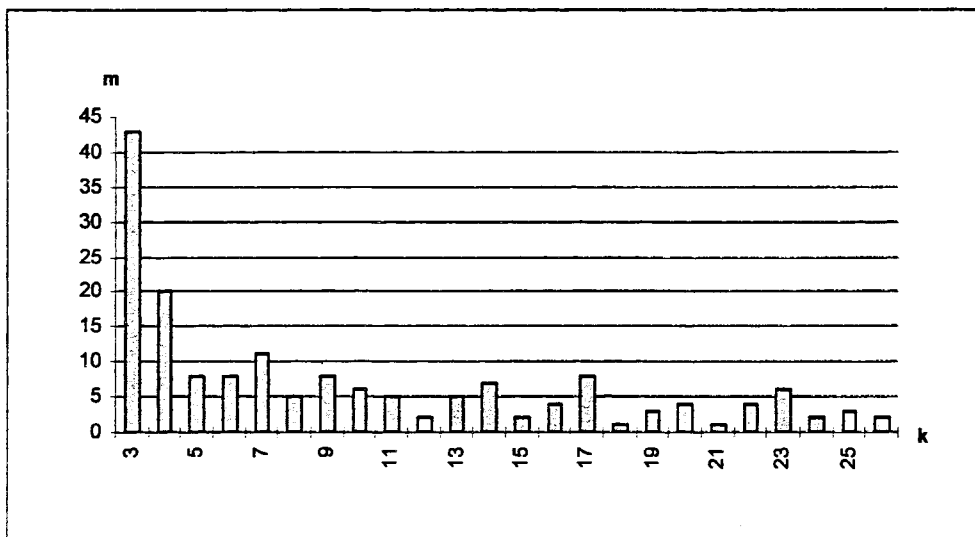

Diagram 1. The number m of Smarandache k - k additive relationships for $n < 10^7$ for $3 \leq k \leq 26$.

The first surprising observation - at least to the author of these lines - is that the number of solutions does not drop off radically as we increase k . In fact there are as many 23-23 additive relationships as there are have 10-10 additive relationships and more than the number of 8-8 relations in the search area $n < 10^7$. The explanation obviously lies in the distribution of the Smarandache function values, which up $n=32000$ is displayed in numerical form on page 56 of the Smarandache Function Journal, vol. 2-3 [1]. This study has been extended to $n \leq 10^7$. The result is shown in table 2 and graphically displayed in diagram 2 where the number of values z of $S(n)$ in the intervals $500000y+1 \leq S(n) \leq 500000(y+1)$ is represented for each interval $500000x+1 \leq n \leq 500000(x+1)$ for $y=0,1,2,\dots,19$ and $x=0,1,2,\dots,19$. The fact that $S(p)=p$ for p prime manifests itself in the line of isolated bars sticking up along the diagonal of the base of the diagram. The next line, which has a gradient = 0.5, corresponds to the fact that $S(2p)=p$. Of course, also the blank squares in the base of the diagram would be filled for n sufficiently large. For the most part, however, the values of $S(n)$ are small compared to n . This corresponds to the large wall running at the back of the diagram. A certain value of $S(n)$ may be repeated a great many times in a given interval. For $n < 10^7$ 82% of all values of n correspond to values of $S(n)$ which are smaller than 500000. It is the occurrence of a great number of values of $S(n)$ which are small compared to n that facilitates the occurrence of equal sums of function

values when sequences of consecutive values of n are considered. If this argument is as important as I think it is then chances are good that it might be possible to find, say, a Smarandache 50-50 additive relationship. I tried it - there are five of them, see table 9. Of the 158 solutions to the 2-2 additive relationships 22 are composed of pairs of prime twins. These are marked by * in table 3. Of course there must be one ascending and one descending pair, as in

$$9369317+199=9369319+197$$

A closer look at the 2-2 additive relationships reveals that only the first two contain composite numbers.

Question 1: For a given prime twin pair $(p,p+2)$ what are the chances that $p+1$ has a prime factor $q \neq 2$ such that $q+2$ is a factor of $p-1$ or $q-2$ a factor of $p+3$?

Question 2: What percentage of such prime twin pairs satisfy the Smarandache 2-2 additive relationship?

Question 3: Are all the Smarandache 2-2 additive relationships for $n > 7$ entirely composed of primes?

To elucidate these questions a bit further this empirical study was extended in the following directions.

1. All Smarandache 2-2 additive relations up to 10^8 were calculated. There are 481 of which 65 are formed by pairs of prime twins.
2. All Smarandache function values involved in these 2-2 additive relationships for $7 < n \leq 10^8$ were prime tested. They are all primes.
3. An analysis of how many of the Smarandache function values for $n < 10^8$ are primes, even composite numbers or odd composite numbers respectively was carried out.

The results of this extended search are summarized by intervals in table 3 from which we can make the following observations. The number of composite values of $S(n)$, even as well as odd, are relatively few and decreasing. In the last interval (table 3) there are only 1996 odd composite values. Even so we know that there are infinitely many composite values of $S(n)$, examples $S(p^2)=2p$, $S(p^3)=3p$ for infinitely many primes p . Nevertheless the scarcity of composite values of $S(n)$ explains why all the 2-2 additive relations examined for $n > 7$ are composite.

The number of 2-2 additive relations is of the order of 0.1 % of the number of prime twins. The 2-2 additive relations formed by pairs of prime twins is about 13.5% of the prime twins in the respective intervals.

Although one has to remember that we are still only "surfing on the ocean of numbers" the following conjecture seems safe to make:

Conjecture: The number of Smarandache 2-2 additive relationships is infinite.

What about $k > 2$? Do k - k additive relations exist for all k ? If not - which is the largest possible value of k ? When they exist, is the number of them infinite or not?

y/x	1	2	3	4	5	6	7	8	9	10	11	12	13	14	15	16	17	18	19	20	Sum
20																				31001	31001
19																			31089		31089
18																		31370			31370
17																	31342				31342
16																31516					31516
15															31613						31613
14														31891							31891
13													31908								31908
12												32049									32049
11											32287										32287
10										32565									16271	16294	65130
9									32802								16437	16365			65604
8								32996							16567	16429					65992
7							33334						16761	16573					11153	11150	88971
6						33744					16921	16823				11328	11250	11166			101232
5					34139				17148	16991			11470	11350	11319		8588	8560	8497	8494	136556
4				34778			17453	17325		11641	11604	11533	8730	8723	8683	15614	7014	6931	12788	12714	185531
3			35657		17971	17686	12033	11852	20793	8950	16060	16066	13102	13119	18125	11059	15515	15488	13592	13483	270551
2		36960	18700	30791	21798	28891	22955	28086	23553	27681	23970	27206	24323	26992	24500	26864	24601	26650	24762	26716	495999
1	499999	463040	445643	434431	426092	419679	414225	409741	405704	402172	399158	396323	393706	391352	389193	387190	385253	383470	381848	380148	8208367

Table 2. The number of values z of $S(n)$ in the intervals $500000y+1 \leq S(n) \leq 500000(y+1)$ is represented for each interval $500000x+1 \leq n \leq 500000(x+1)$ for $y=0,1,2,\dots,19$ and $x=0,1,2,\dots,19$.

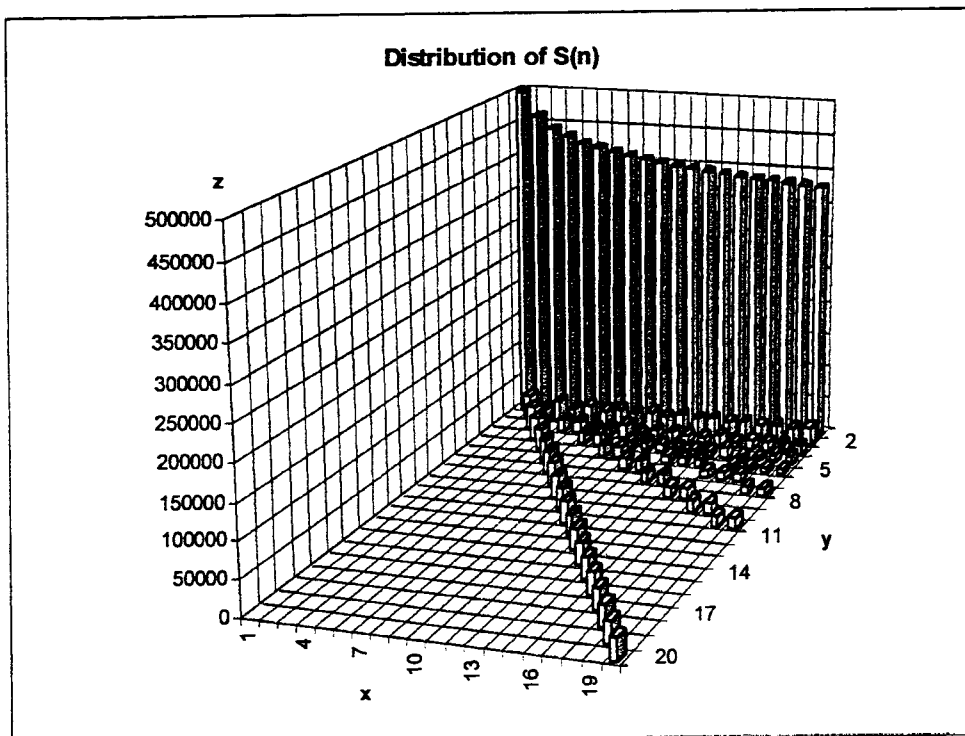

Diagram 2. The distribution of $S(n)$ for $n < 10^7$.

Table 3. Comparison between 2-2 additive relations and other relevant data.

Interval	# of prime twins	# of 2-2 additive relations	# of formed pairs of twins	# of S. function primes	# of S. function even values	# of S. odd composite values
$n \leq 10^7$	58980	158	22	9932747	59037	8215
$10^7 < n \leq 2 \cdot 10^7$	48427	59	9	9957779	38023	4198
$2 \cdot 10^7 < n \leq 3 \cdot 10^7$	45485	37	4	9963674	32922	3404
$3 \cdot 10^7 < n \leq 4 \cdot 10^7$	43861	42	4	9967080	29960	2960
$4 \cdot 10^7 < n \leq 5 \cdot 10^7$	42348	40	5	9969366	27962	2672
$5 \cdot 10^7 < n \leq 6 \cdot 10^7$	41547	30	2	9971043	26473	2484
$6 \cdot 10^7 < n \leq 7 \cdot 10^7$	40908	28	4	9972374	25303	2323
$7 \cdot 10^7 < n \leq 8 \cdot 10^7$	39984	41	7	9973482	24327	2191
$8 \cdot 10^7 < n \leq 9 \cdot 10^7$	39640	20	4	9974414	23521	2065
$9 \cdot 10^7 < n \leq 10^8$	39222	26	4	9975179	22825	1996
Total	440402	481	65	99657140	310355	9999999

Table 4. Smarandache function: 2-2 additive quadruplets for $n < 10^7$

#	n	S(n)	S(n+1)	S(n+2)	S(n+3)
1	6	3	7	4	6
2	7	7	4	6	5
3	28	7	29	5	31
4	114	19	23	29	13
5	1720	43	1721	41	1723
6	3538	61	3539	59	3541
7	4313	227	719	863	83
8	8474	223	113	163	173
9	10300	103	10301	101	10303
10	13052	251	229	107	373
11	15417	571	593	907	257
12	15688	53	541	523	71
13	19902	107	1531	311	1327
14	22194	137	193	179	151
15	22503	577	97	643	31
16	24822	197	241	107	331
17	26413	433	281	587	127
18	56349	2087	23	1523	587
19	70964	157	83	137	103
20	75601	173	367	79	461
21	78610	1123	6047	6551	619
22	86505	79	167	157	89
23	104309	104309	61	104311	59
24	107083	6299	1409	59	7649
25	108016	157	1187	353	991
26	108845	1979	6047	1223	6803
27	125411	877	1493	1511	859
28	130254	1277	239	1163	353
29	133455	41	439	421	59
30	147963	43	521	293	271
31	171794	1753	881	1481	1153
32	187369	71	457	191	337
33	189565	1223	317	59	1481
34	191289	9109	47	8317	839
35	198202	877	131	199	809
36	232086	823	151	433	541
37	247337	247337	151	247339	149
38	269124	547	2153	941	1759
39	286080	149	547	457	239
40	323405	911	113	983	41
41	330011	1579	103	631	1051
42	342149	79	2281	109	2251
43	403622	6959	151	3881	3229
44	407164	743	673	859	557
45	421474	2539	733	103	3169
46	427159	25127	181	20341	4967
47	479026	193	479027	191	479029
48	497809	257	743	227	773
49	526879	12253	89	10331	2011
50	539561	271	4733	1867	3137
51	564029	179	2089	1009	1259
52	598517	449	811	109	1151
53	603597	1163	3391	4051	503
54	604148	2069	2213	281	4001
55	604901	433	557	79	911
56	618029	618029	109	618031	107

Table 4. ctd

#	n	S(n)	S(n+1)	S(n+2)	S(n+3)	
57	662383	4219	41399	44159	1459	
58	665574	53	337	307	83	
59	675550	229	675551	227	675553	*
60	681088	313	681089	311	681091	*
61	722750	59	2339	491	1907	
62	753505	4073	397	2887	1583	
63	766172	1583	181	151	1613	
64	771457	2137	283	151	2269	
65	867894	1831	181	691	1321	
66	922129	797	101	41	857	
67	942669	1151	881	1553	479	
68	954087	10259	499	157	10601	
69	993299	2663	43	2273	433	
70	996091	2269	277	163	2383	
71	1008988	103	1008989	101	1008991	*
72	1114271	1114271	73	1114273	71	*
73	1184610	5641	4099	109	9631	
74	1198734	829	5101	139	5791	
75	1316412	239	1039	1129	149	
76	1343493	2927	3517	5717	727	
77	1353260	953	4957	4481	1429	
78	1362471	53	2333	1289	1097	
79	1382345	14551	53	14251	353	
80	1397236	2143	2447	3947	643	
81	1457061	1049	331	1321	59	
82	1457181	359	233	239	353	
83	1570143	2347	353	109	2591	
84	1625615	7561	71	439	7193	
85	1811933	24821	2341	19073	8089	
86	1850825	733	827	1489	71	
87	1885822	1471	479	1637	313	
88	1920649	2837	359	1283	1913	
89	2134118	113	54721	53353	1481	
90	2147188	23339	127	3767	19699	
91	2223285	269	367	563	73	
92	2300608	349	2300609	347	2300611	*
93	2316257	191	593	137	647	
94	2507609	2879	11941	14009	811	
95	2575700	599	541	311	829	
96	2683547	4421	463	4603	281	
97	2721286	1373	2131	1597	1907	
98	2774925	4111	487	151	4447	
99	2882422	1321	307	1447	181	
100	2965675	379	15131	223	15287	
101	3053808	7069	3803	9851	1021	
102	3058649	2551	971	2351	1171	
103	3063696	769	257	887	139	
104	3112450	5659	1913	179	7393	
105	3192189	1063	317	1217	163	
106	3369359	15527	139	14843	823	
107	3523174	3001	2659	5437	223	
108	3532407	197	293	401	89	
109	3575518	193	3575519	191	3575521	*
110	3669327	3673	59	3559	173	
111	3682461	643	7109	7321	431	
112	3847270	61	3847271	59	3847273	*

Table 4. ctd

#	n	S (n)	S (n+1)	S (n+2)	S (n+3)
113	3946899	131	1361	311	1181
114	3996604	13687	2087	223	15551
115	3996924	1327	149	617	859
116	4003753	2351	271	2243	379
117	4083279	421	1187	199	1409
118	4089287	4089287	241	4089289	239
119	4176254	1087	2003	79	3011
120	4231135	22871	1453	13693	10631
121	4319374	4243	6911	107	11047
122	4330089	3229	761	3313	677
123	4407890	241	3701	3761	181
124	4460749	1021	2549	211	3359
125	4466394	773	2063	1223	1613
126	4497910	2017	359	349	2027
127	4527424	109	631	241	499
128	4964380	619	4964381	617	4964383
129	5041464	2659	641	239	3061
130	5223823	1987	2003	109	3881
131	5225875	431	1321	433	1319
132	5567370	1229	3739	3877	1091
133	5808409	439	20029	13171	7297
134	6086323	11549	6703	11593	6659
135	6149140	2347	8747	4951	6143
136	6278729	1373	73	967	479
137	6598417	277	2389	1747	919
138	6611721	24763	2333	859	26237
139	6662125	239	45631	8017	37853
140	7019712	1741	25903	7297	20347
141	7083088	9419	12671	11243	10847
142	7208864	43	797	661	179
143	7450168	2731	7450169	2729	7450171
144	7535995	14633	6301	13291	7643
145	7699506	179	3121	1867	1433
146	7717006	151	7717007	149	7717009
147	7951133	274177	1249	26953	248473
148	8161388	10253	443	9833	863
149	8246970	2131	3929	5273	787
150	8406659	227207	140111	365507	1811
151	8822215	1663	2069	2903	829
152	8840170	349	8840171	347	8840173
153	9050492	3881	6719	137	10463
154	9369317	9369317	199	9369319	197
155	9558822	61	6203	5717	547
156	9616088	2027	4201	107	6121
157	9739368	109	4877	4253	733
158	9944053	2917	17569	20089	397

Table 5. Smarandache function: 3-3 additive sextets for $n < 10^7$

#	n	S(n)	S(n+1)	S(n+2)	S(n+3)	S(n+4)	S(n+5)
1	5	5	3	7	4	6	5
2	5182	2591	73	9	61	2593	19
3	9855	73	11	9857	53	9859	29
4	10428	79	10429	149	61	163	10433
5	28373	1669	4729	227	3547	1051	2027
6	32589	71	3259	109	97	2963	379
7	83323	859	563	101	683	809	31
8	106488	29	1283	463	461	337	977
9	113409	12601	1031	127	727	4931	8101
10	146572	36643	20939	479	41	9161	48859
11	257474	347	3433	1091	263	3301	1307
12	294742	569	1223	12281	233	8669	5171
13	448137	101	224069	448139	97	448141	224071
14	453250	37	14621	353	1613	13331	67
15	465447	1373	797	6947	107	59	8951
16	831096	97	4643	21871	617	8311	17683
17	1164960	809	1021	1669	673	1283	1543
18	1279039	1279039	571	691	347	1279043	911
19	1348296	56179	2447	499	49937	139	9049
20	1428620	1171	2393	2389	1607	3307	1039
21	1544770	863	1877	193	1021	1433	479
22	1680357	71	840179	1680359	67	1680361	840181
23	1917568	211	1917569	1559	1917571	1049	719
24	2466880	593	2466881	4153	2466883	4637	107
25	2475373	6173	3041	41	1181	6857	1217
26	3199719	15919	479	2297	13007	5087	601
27	3618482	1973	2333	419	311	593	3821
28	4217047	557	277	499	193	317	823
29	4239054	191	11941	863	4993	3359	4643
30	5022920	17939	1483	613	1229	18199	607
31	5154719	131	10739	113	3109	4813	3061
32	5488091	2221	971	1307	1987	2423	89
33	6093975	421	108821	271	92333	7351	9829
34	6597860	7019	9439	11657	23819	53	4243
35	6667100	29	1091	11149	659	1877	9733
36	6964515	2243	1999	1597	181	4549	1109
37	7092334	82469	45757	1063	3061	1801	124427
38	7394240	3301	2087	883	509	139	5623
39	7912020	809	35801	15761	16381	7219	28771
40	8741057	1321	653	9967	547	6607	4787
41	8823577	180073	259517	23159	441179	257	21313
42	9171411	2179	1999	479	1277	577	2803
43	9975698	947	173	14251	3677	523	11171

Table 6. Smarandache function: 4-4 additive octets for $n < 10^7$

#	n	S(n)	S(n+1)	S(n+2)	S(n+3)	S(n+4)	S(n+5)	S(n+6)	S(n+7)
1	23	23	4	10	13	9	7	29	5
2	643	643	23	43	19	647	9	59	13
3	10409	1487	347	359	137	89	127	2083	31
4	44418	673	1033	2221	67	167	1433	617	1777
5	163329	54443	16333	23333	349	701	81667	10889	1201
6	279577	279577	10753	2273	1997	3539	2741	279583	8737
7	323294	1483	3079	10103	1913	5987	10429	61	101
8	368680	709	2903	1429	1699	1511	2731	2221	277
9	857434	8089	769	71453	353	11587	2887	233	65957
10	1545493	1545493	1669	359	3167	389	4519	1545499	281
11	2458284	204857	28921	53441	21011	467	2339	81943	223481
12	3546232	19273	3546233	3863	151	1609	16649	5023	3546239
13	3883322	8707	3709	12289	155333	2287	32633	1291	143827
14	4945200	317	3299	9851	139	673	5717	6197	1019
15	5219814	1259	2411	5483	4339	2003	241	617	10631
16	6055151	128833	1249	465781	432511	14951	1559	2671	1009193
17	6572015	3137	461	31147	523	6277	157	24251	4583
18	7096751	7096751	223	457	506911	473117	30071	7096757	4397
19	7217695	4021	4799	2131	3608849	191	491	10267	3608851
20	7530545	5953	383	175129	6947	547	150611	34703	2551

Table 7. Smarandache function: 5-5 additive relationships for $n < 10^7$

#	n	S(n+1)	S(n+1)	S(n)	S(n+1)	S(n+2)	S(n+3)	S(n+4)	S(n+5)	S(n+6)	S(n+7)
1	13	13	7	5	6	17	6	19	5	7	11
2	570	19	571	13	191	41	23	8	577	34	193
3	1230	41	1231	11	137	617	19	103	1237	619	59
4	392152	49019	392153	9337	733	79	43573	15083	392159	43	463
5	1984525	487	992263	2371	47	1091	797	701	53	2441	992267
6	4730276	5303	54371	17783	36109	39419	3011	2819	6653	5351	135151
7	5798379	8087	499	2339	2677	2417	8839	139	587	2927	3527
8	5838665	7253	7103	227	132697	107	4457	9463	17377	37189	78901

Table 8. Smarandache function: 6-6 additive relationships for $n < 10^7$

#	n	S(n)	S(n+1)	S(n+2)	S(n+3)	S(n+4)	S(n+5)	S(n+6)	S(n+7)	S(n+8)	S(n+9)	S(n+10)	S(n+11)
1	14	7	5	6	17	6	19	5	7	11	23	4	10
2	158	79	53	8	23	9	163	41	11	83	167	7	26
3	20873	20873	71	167	307	6959	73	20879	29	157	197	6961	227
4	21633	7211	373	4327	601	281	349	7213	541	67	3607	941	773
5	103515	103	3697	1697	71	7963	647	3137	271	643	8627	101	1399
6	132899	10223	443	383	863	14767	449	1399	1303	4583	223	6329	13291
7	368177	661	61363	353	449	3719	9689	1301	46	73637	34	107	1109
8	5559373	5559373	1447	593	15107	3253	643	3323	1193	10837	293	5559383	5387

Table 9. Smarandache function 50-50 additive relations

	n=1876		n=16539		n=58631		n=109606		n=2385965	
S(n)/S(n+51)	67	107	149	313	58631	101	7829	1523	1087	7823
S(n+1)/S(n+52)	1877	47	827	79	349	61	2549	2069	36151	431
S(n+2)/S(n+53)	313	241	139	353	3449	631	4567	54829	140351	1091
S(n+3)/S(n+54)	1879	643	919	61	1543	863	109609	3323	11471	70177
S(n+4)/S(n+55)	47	193	233	5531	1303	97	113	5483	795323	1093
S(n+5)/S(n+56)	19	1931	47	8297	137	9781	641	109661	601	23
S(n+6)/S(n+57)	941	23	1103	3319	307	58687	409	373	1213	216911
S(n+7)/S(n+58)	269	1933	8273	461	337	131	2237	109663	347	1193011
S(n+8)/S(n+59)	157	967	16547	2371	8377	6521	18269	149	8431	1151
S(n+9)/S(n+60)	29	43	197	193	733	5869	1993	2437	51869	2953
S(n+10)/S(n+61)	41	22	67	503	1777	3089	31	54833	1097	95441
S(n+11)/S(n+62)	37	149	331	83	269	73	599	6451	298247	1867
S(n+12)/S(n+63)	59	19	613	1277	347	58693	2383	37	6997	7927
S(n+13)/S(n+64)	1889	277	2069	2767	181	29347	109619	15667	56809	596507
S(n+14)/S(n+65)	9	97	16553	16603	317	43	29	997	2385979	795343
S(n+15)/S(n+66)	61	647	89	593	71	29	109621	263	119299	887
S(n+16)/S(n+67)	43	971	43	41	173	743	929	13709	20393	2386031
S(n+17)/S(n+68)	631	67	4139	38	7331	1087	36541	109673	1697	4519
S(n+18)/S(n+69)	947	12	5519	16607	263	58699	193	677	2385983	6329
S(n+19)/S(n+70)	379	389	487	173	23	587	877	107	43	1301
S(n+20)/S(n+71)	79	139	571	977	659	1151	151	3917	68171	3119
S(n+21)/S(n+72)	271	59	23	151	43	599	15661	36559	2657	14549
S(n+22)/S(n+73)	73	487	16561	113	21	1249	27407	61	795329	30203
S(n+23)/S(n+74)	211	1949	26	4153	29327	1223	937	1637	257	397673
S(n+24)/S(n+75)	19	13	5521	449	11731	199	577	457	2385989	4051
S(n+25)/S(n+76)	1901	1951	101	71	47	197	2963	59	8837	59651
S(n+26)/S(n+77)	317	61	3313	3323	58657	593	571	317	2385991	113621
S(n+27)/S(n+78)	173	31	251	67	211	1129	6449	1741	311	1193021
S(n+28)/S(n+79)	17	977	16567	191	19553	8387	191	1613	7433	9431
S(n+29)/S(n+80)	127	23	109	1187	419	103	7309	21937	563	22093
S(n+30)/S(n+81)	953	163	263	16619	58661	58711	27409	181	113	477209
S(n+31)/S(n+82)	1907	103	1657	277	3259	179	9967	251	198833	91771
S(n+32)/S(n+83)	53	89	227	1511	5333	19571	6091	13711	457	795349
S(n+33)/S(n+84)	83	653	1381	8311	7333	947	109639	36563	2693	2663
S(n+34)/S(n+85)	191	14	16573	1847	3911	11743	2741	1567	313	50767
S(n+35)/S(n+86)	14	53	8287	1039	29333	233	227	479	1193	15907
S(n+36)/S(n+87)	239	109	17	19	34	827	4217	277	89	2386051
S(n+37)/S(n+88)	1913	151	37	163	4889	157	1321	2551	8461	35089
S(n+38)/S(n+89)	29	491	137	1279	4513	46	9137	4219	2386003	265117
S(n+39)/S(n+90)	383	131	307	4157	5867	367	21929	103	307	108457
S(n+40)/S(n+91)	479	983	281	241	53	4517	751	857	2179	9739
S(n+41)/S(n+92)	71	281	829	1663	193	9787	131	15671	251	2687
S(n+42)/S(n+93)	137	41	5527	16631	2551	8389	89	389	3463	2386057
S(n+43)/S(n+94)	101	179	8291	11	127	277	199	673	1069	62791
S(n+44)/S(n+95)	8	197	103	16633	2347	29	43	1097	2386009	317
S(n+45)/S(n+96)	113	73	691	8317	14669	29363	2333	239	199	2251
S(n+46)/S(n+97)	62	29	107	1109	19559	58727	347	54851	795337	2386061
S(n+47)/S(n+98)	641	1973	8293	4159	29339	2447	36551	9973	596503	653
S(n+48)/S(n+99)	37	47	97	131	58679	281	503	653	340859	2386063
S(n+49)/S(n+100)	11	79	29	59	163	839	241	593	727	757
Sum	20307	20307	154521	154521	457399	457399	705120	705120	18703984	18703984

References

1. H. Ibstedt, The Smarandache Function S(n), *Smarandache Function Journal*, Vol. 2-3, No 1, pgs 43-50.
2. M. Bencze, Smarandache Relationships and Subsequences, *Smarandache Notions Journal*, Vol. 11, No 1-2-3, pgs 79-85.
3. H. Ibstedt, Non-Recursive Sequences, *Computer Analysis of Number Sequences*, American Research Press, 1998.

Appendix to article on Smarandache k-k additive relationships

Henry Ibstedt

The numerical material which was produced in relation to the above study was considered too much to include in the article because the author did not want to distract readers from the essential parts of the study. At the request of ARP the material not included in the article has been edited in the tables below so that the material of this study is complete.

Table 1. Smarandache function 7-7 additive relations

n	#1 13	#2 210	#3 47760	#4 48594	#5 60943	#6 103305	#7 163823	#8 252061	#9 349033	#10 3280590	#11 5364719
S(n)	13	7	199	89	60943	97	281	173	8513	36451	5364719
S(n+1)	7	211	6823	9719	293	157	3413	126031	233	3280591	7451
S(n+2)	5	53	167	12149	239	103307	6553	4001	23269	1723	114143
S(n+3)	6	71	61	167	983	8609	6301	7877	1229	1093531	243851
S(n+4)	17	107	11941	94	1033	103	167	4583	26849	30949	457
S(n+5)	6	43	233	2113	1693	10331	5851	977	19391	656119	78893
S(n+6)	19	9	419	12	8707	883	419	569	349039	857	214589
Sum	73	501	19843	24343	73891	123487	22985	144211	428523	5100221	6024103
S(n+7)	5	31	1291	131	53	587	127	53	4363	172663	47059
S(n+8)	7	109	853	1279	1847	14759	947	1151	1511	1640299	5689
S(n+9)	11	73	15923	953	401	257	20479	277	2861	173	4441
S(n+10)	23	11	281	419	60953	20663	563	3037	349043	349	596081
S(n+11)	4	17	67	9721	10159	1123	677	389	59	5827	443
S(n+12)	10	37	1327	8101	167	34439	151	13267	69809	307	5364731
S(n+13)	13	223	101	3739	311	51659	41	126037	877	3280603	5659
Sum	73	501	19843	24343	73891	123487	22985	144211	428523	5100221	6024103

Table 2. Smarandache 8-8 additive relations

n	#1 628	#2 1490	#3 80175	#4 1569560	#5 6285978
S(n)	157	149	1069	39239	1973
S(n+1)	37	71	5011	2411	313
S(n+2)	7	373	80177	19141	314299
S(n+3)	631	1493	83	2441	1811
S(n+4)	79	83	197	14533	108379
S(n+5)	211	23	211	6679	571453
S(n+6)	317	17	151	229	65479
S(n+7)	127	499	853	18041	17707
Sum	1566	2708	87752	102714	1081414
S(n+8)	53	107	443	21	448999
S(n+9)	14	1499	257	1423	6781
S(n+10)	29	15	79	463	953
S(n+11)	71	79	40093	82609	103049
S(n+12)	8	751	26729	4967	209533
S(n+13)	641	167	20047	2389	12497
S(n+14)	107	47	89	1873	269
S(n+15)	643	43	15	8969	299333
Sum	1566	2708	87752	102714	1081414

Table 3. Smarandache 9-9 additive relations

n	#1 111	#2 156	#3 411	#4 41650	#5 60179	#6 79317	#7 633483	#8 7310358
S(n)	37	13	137	17	8597	1259	1193	397
S(n+1)	7	157	103	41651	59	39659	158371	21313
S(n+2)	113	79	59	89	5471	79319	67	1021
S(n+3)	19	53	23	1811	30091	661	15083	2436787
S(n+4)	23	8	83	353	743	7211	633487	59921
S(n+5)	29	23	13	2777	7523	2333	137	48413
S(n+6)	13	9	139	127	12037	193	9181	32063
S(n+7)	59	163	19	541	1433	2833	443	5689
S(n+8)	17	41	419	131	433	167	15451	311
Sum	317	546	995	47497	66387	133635	833413	2605915
S(n+9)	5	11	7	41659	367	113	17597	3547
S(n+10)	22	83	421	2083	20063	3449	90499	17573
S(n+11)	61	167	211	1543	463	67	4339	664579
S(n+12)	41	7	47	563	2617	853	269	3637
S(n+13)	31	26	53	683	19	7933	79187	82139
S(n+14)	15	17	17	31	8599	1619	633497	1827593
S(n+15)	7	19	71	641	30097	601	5557	4903
S(n+16)	127	43	61	251	4013	79333	2287	1693
S(n+17)	8	173	107	43	149	39667	181	251
Sum	317	546	995	47497	66387	133635	833413	2605915

Table 4. Smarandache 10-10 additive relations

n	#1 23564	#2 44237	#3 45202	#4 245301	#5 282215	#6 545002
S(n)	137	1427	233	11681	56443	719
S(n+1)	1571	101	2659	122651	1069	32059
S(n+2)	11783	83	3767	193	1277	15139
S(n+3)	23567	79	9041	3407	1933	109001
S(n+4)	491	14747	3229	691	151	3539
S(n+5)	37	2011	5023	122653	137	181669
S(n+6)	2357	293	5651	81769	282221	1481
S(n+7)	97	1229	853	8761	15679	1423
S(n+8)	83	8849	137	12911	769	491
S(n+9)	2143	22123	1559	37	569	17581
Sum	42266	50942	32152	364754	360248	363102
S(n+10)	3929	43	127	769	71	223
S(n+11)	41	5531	2153	3833	1061	211
S(n+12)	421	44249	47	281	25657	272507
S(n+13)	271	59	9043	709	811	5737
S(n+14)	11789	137	157	163	282229	22709
S(n+15)	73	37	439	20443	167	49547
S(n+16)	131	149	983	245317	10453	3733
S(n+17)	23581	109	15073	5333	35279	1307
S(n+18)	907	167	19	81773	1753	229
S(n+19)	1123	461	4111	6133	2767	6899
Sum	42266	50942	32152	364754	360248	363102

Table 5. Smarandache 11-11 additive relations

n	#1 1402	#2 25102	#3 55919	#4 84274	#5 2335403
S(n)	701	163	281	1453	127
S(n+1)	61	1931	233	3371	10243
S(n+2)	13	523	55921	2341	467081
S(n+3)	281	5021	27961	1187	1167703
S(n+4)	37	12553	2663	42139	778469
S(n+5)	67	8369	41	2161	145963
S(n+6)	11	6277	2237	43	8081
S(n+7)	1409	211	239	311	337
S(n+8)	47	31	55927	1277	1063
S(n+9)	83	25111	6991	947	583853
S(n+10)	353	73	181	1109	4349
Sum	3063	60263	152675	56339	3167269
S(n+11)	157	761	47	1873	1167707
S(n+12)	101	433	55931	67	467083
S(n+13)	283	5023	79	12041	73
S(n+14)	59	23	55933	439	333631
S(n+15)	109	25117	27967	2719	1167709
S(n+16)	709	661	113	8429	1291
S(n+17)	43	2791	23	28097	5077
S(n+18)	71	157	131	1621	19301
S(n+19)	29	25121	9323	97	3779
S(n+20)	79	79	331	223	1217
S(n+21)	1423	97	2797	733	401
Sum	3063	60263	152675	56339	3167269

Table 6. Smarandache 12-12 additive relations

n	#1 19971	#2 218296
S(n)	317	2099
S(n+1)	4993	12841
S(n+2)	19973	36383
S(n+3)	3329	521
S(n+4)	47	59
S(n+5)	227	72767
S(n+6)	6659	503
S(n+7)	1427	1097
S(n+8)	19979	379
S(n+9)	37	43661
S(n+10)	53	9923
S(n+11)	103	1373
Sum	57144	181606
S(n+12)	6661	54577
S(n+13)	1249	2399
S(n+14)	571	383
S(n+15)	3331	5077
S(n+16)	79	941
S(n+17)	263	191
S(n+18)	2221	6421
S(n+19)	1999	929
S(n+20)	19991	113
S(n+21)	17	223
S(n+22)	19993	109159
S(n+23)	769	1193
Sum	57144	181606

Table 7. Smarandache 13-13 additive relations

n	#1 1578	#2 3314	#3 29672	#4 230926	#5 623110
S(n)	263	1657	3709	103	62311
S(n+1)	1579	17	157	7963	3163
S(n+2)	79	829	401	283	3709
S(n+3)	31	107	1187	230929	337
S(n+4)	113	79	2473	3299	311557
S(n+5)	1583	3319	503	2851	227
S(n+6)	11	83	71	4441	521
S(n+7)	317	41	761	230933	1531
S(n+8)	61	151	53	3499	149
S(n+9)	46	3323	443	46187	89017
S(n+10)	397	277	97	28867	7789
S(n+11)	227	19	29683	1571	3919
S(n+12)	53	1663	181	115469	311561
Sum	4760	11565	39719	676395	795791
S(n+13)	43	1109	1979	230939	21487
S(n+14)	199	13	14843	1283	911
S(n+15)	59	3329	4241	230941	997
S(n+16)	797	37	1237	115471	947
S(n+17)	29	3331	2699	3347	207709
S(n+18)	19	17	2969	1031	97
S(n+19)	1597	101	3299	19	47933
S(n+20)	47	1667	571	631	20771
Sum	41	29	1291	1471	20101
S(n+21)	10	139	101	57737	155783
S(n+22)	1601	71	5939	383	157
S(n+23)	89	1669	29	149	311567
S(n+24)	229	53	521	32993	7331
Sum	4760	11565	39719	676395	795791

Table 8. Smarandache 14-14 additive relations

n	#1 154	#2 1282	#3 2413	#4 13322	#5 1454678	#6 2435152	#7 4727685
S(n)	11	641	127	6661	38281	152197	315179
S(n+1)	31	1283	71	4441	17959	49697	76253
S(n+2)	13	107	23	3331	887	521	4727687
S(n+3)	157	257	151	41	63247	13163	263
S(n+4)	79	643	2417	2221	242447	608789	4727689
S(n+5)	53	13	31	13327	1454683	90191	42979
S(n+6)	8	23	59	17	4723	1559	525299
S(n+7)	23	1289	22	1481	96979	641	1181923
S(n+8)	9	43	269	43	727343	223	10211
S(n+9)	163	1291	173	13331	751	2435161	367
S(n+10)	41	19	2423	101	5051	3613	135077
S(n+11)	11	431	101	199	1454689	4079	443
S(n+12)	83	647	97	113	199	12953	503
S(n+13)	167	37	1213	127	1307	28649	4027
Sum	849	6724	7177	45434	4108546	3401436	11747900
S(n+14)	7	9	809	1667	9829	2293	64763
S(n+15)	26	1297	607	13337	1759	1051	103
S(n+16)	17	59	347	19	242449	76099	429791
S(n+17)	19	433	12	13339	26449	677	2659
S(n+18)	43	13	17	29	181837	243517	1613
S(n+19)	173	1301	19	4447	181	443	590963
S(n+20)	29	31	811	953	3583	202931	4129
S(n+21)	10	1303	1217	1213	1454699	9859	14867
S(n+22)	11	163	487	139	373	181	4727707
S(n+23)	59	29	29	157	1454701	137	1181927
S(n+24)	89	653	2437	6673	727351	7079	743
S(n+25)	179	1307	53	1483	4801	16127	887
S(n+26)	6	109	271	71	67	405863	4727711
S(n+27)	181	17	61	1907	467	2435179	37
Sum	849	6724	7177	45434	4108546	3401436	11747900

Table 9. Smarandache 15-15 additive relations

n	#1 5978	#2 115686
S(n)	61	6427
S(n+1)	1993	809
S(n+2)	23	14461
S(n+3)	5981	787
S(n+4)	997	503
S(n+5)	193	6089
S(n+6)	17	311
S(n+7)	19	115693
S(n+8)	73	57847
S(n+9)	5987	857
S(n+10)	499	1033
S(n+11)	113	911
S(n+12)	599	1753
S(n+13)	1997	59
S(n+14)	107	89
Sum	18659	207629
S(n+15)	461	38567
S(n+16)	37	83
S(n+17)	109	16529
S(n+18)	1499	1607
S(n+19)	1999	317
S(n+20)	2999	57853
S(n+21)	857	38569
S(n+22)	15	28927
S(n+23)	353	157
S(n+24)	3001	29
S(n+25)	29	461
S(n+26)	79	113
S(n+27)	1201	43
S(n+28)	13	1231
S(n+29)	6007	23143
Sum	18659	207629

Table 10. Smarandache 16-16 additive relations

n	#1	#2	#3	#4
S(n)	2243	2411	1069441	1175971
S(n+1)	17	67	48611	41999
S(n+2)	449	127	163	5521
S(n+3)	1123	71	6521	587987
S(n+4)	107	23	16453	2767
S(n+5)	281	151	25463	16333
S(n+6)	173	2417	1459	106907
S(n+7)	15	31	3613	587989
S(n+8)	2251	59	3461	1931
S(n+9)	563	22	293	4523
S(n+10)	751	269	1069451	1175981
S(n+11)	23	173	487	195997
S(n+12)	41	2423	43	3389
S(n+13)	47	101	347	1097
S(n+14)	61	97	859	281
S(n+15)	1129	1213	66841	4421
Sum	9274	9655	2313506	2737982
S(n+16)	251	809	3779	191.
S(n+17)	113	607	13711	151
S(n+18)	19	347	1069459	1175989
S(n+19)	29	12	7639	5113
S(n+20)	73	17	359	3469
S(n+21)	283	19	18439	8647
S(n+22)	151	811	1069463	12923
S(n+23)	103	1217	4051	827
S(n+24)	2267	487	1999	235199
S(n+25)	9	29	3847	293999
S(n+26)	2269	2437	401	391999
S(n+27)	227	53	1601	587999
S(n+28)	757	271	34499	9719
S(n+29)	71	61	233	15
S(n+30)	2273	2441	82267	10789
S(n+31)	379	37	1759	953
Sum	9274	9655	2313506	2737982

Table 11. Smarandache 17-17 additive relations

n	#1	#2	#3	#4	#5	#6	#7	#8
S(n)	29	79	229	67049	5081	751	187921	263
S(n+1)	41	89	47	19157	335347	231809	169129	6269
S(n+2)	349	31	131	149	6449	7559	83	271
S(n+3)	233	17	367	167	5323	99347	1453	11701
S(n+4)	10	13	17	3529	353	7727	1691293	5741
S(n+5)	701	179	167	44701	757	331	1303	22721
S(n+6)	13	239	919	16763	157	86929	2399	429427
S(n+7)	37	359	613	26821	683	3929	3109	4583
S(n+8)	11	719	23	103	167677	347717	1691297	211
S(n+9)	47	6	263	2273	283	823	433	39397
S(n+10)	353	103	307	2579	59	487	11351	2147137
S(n+11)	101	38	97	4967	709	8803	1301	1847
S(n+12)	59	241	461	13411	601	18301	2833	1489
S(n+13)	709	181	41	3271	19727	599	1481	330329
S(n+14)	71	29	71	127	131	8693	1691303	3911
S(n+15)	79	22	1847	23	8599	695441	3709	390389
S(n+16)	89	727	11	67057	2297	257	191	107357
Sum	2932	3072	5611	272147	554233	1519503	5460589	3503043
S(n+17)	31	13	86	8941	2083	99349	845653	33289
S(n+18)	17	15	37	33529	27947	173861	1693	27179
S(n+19)	13	73	617	3119	67073	653	422827	613469
S(n+20)	179	43	463	7451	167683	3907	58321	15559
S(n+21)	239	61	109	1889	12421	695447	56377	2659
S(n+22)	359	733	103	479	103	743	271	4373
S(n+23)	719	367	53	181	929	23981	15101	4919
S(n+24)	6	14	29	67061	1597	1987	2551	863
S(n+25)	103	23	619	137	2221	10079	845657	28439
S(n+26)	38	67	929	11177	83843	127	338263	26
S(n+27)	241	41	26	37	111791	3719	4271	148079
S(n+28)	181	739	31	337	12899	3739	6581	1073573
S(n+29)	29	37	1861	2129	2683	139091	845659	20161
S(n+32)	22	19	19	101	137	211	1873	58031
S(n+32)	727	53	23	134129	47911	83	42283	858859
S(n+32)	13	743	233	263	2749	347729	1691321	94
S(n+32)	15	31	373	1187	10163	14797	281887	613471
Sum	2932	3072	5611	272147	554233	1519503	5460589	3503043

Table 12. Smarandache 18-18 additive relations

n	#1
S(n)	509
S(n+1)	334447
S(n+2)	34361
S(n+3)	5016707
S(n+4)	46451
S(n+5)	9629
S(n+6)	17299
S(n+7)	4049
S(n+8)	627089
S(n+9)	385901
S(n+10)	36353
S(n+11)	1721
S(n+12)	1254179
S(n+13)	32789
S(n+14)	103
S(n+15)	3307
S(n+16)	20903
S(n+17)	5016721
Sum	12842518
S(n+18)	132019
S(n+19)	7177
S(n+20)	29167
S(n+21)	263
S(n+22)	1949
S(n+23)	5016727
S(n+24)	627091
S(n+25)	1672243
S(n+26)	16183
S(n+27)	5016731
S(n+28)	59723
S(n+29)	106739
S(n+30)	147551
S(n+31)	4129
S(n+32)	743
S(n+33)	251
S(n+34)	1931
S(n+35)	1901
Sum	12842518

**Table 13. Smarandache Function
19-19 additive relationships**

n	#1 1759	#2 11709	#2 1205949
S(n)	1759	1301	21157
S(n+1)	11	1171	271
S(n+2)	587	239	1205951
S(n+3)	881	61	571
S(n+4)	43	53	172279
S(n+5)	14	5857	602977
S(n+6)	353	71	8933
S(n+7)	883	101	301489
S(n+8)	31	11717	1487
S(n+9)	17	31	15461
S(n+10)	61	11719	52433
S(n+11)	59	293	73
S(n+12)	23	3907	401987
S(n+13)	443	5861	367
S(n+14)	197	617	6449
S(n+15)	887	977	241
S(n+16)	71	67	8317
S(n+17)	37	41	602983
S(n+18)	1777	1303	57427
Sum	8134	45387	3460853
S(n+19)	127	733	3967
S(n+20)	593	317	1205969
S(n+21)	89	23	659
S(n+22)	137	11731	92767
S(n+23)	11	419	301493
S(n+24)	1783	3911	2851
S(n+25)	223	5867	191
S(n+26)	17	2347	48239
S(n+27)	47	163	461
S(n+28)	1787	97	1205977
S(n+29)	149	5869	379
S(n+30)	1789	43	401993
S(n+31)	179	587	3547
S(n+32)	199	199	172283
S(n+33)	10	103	971
S(n+34)	163	11743	6971
S(n+35)	23	367	223
S(n+36)	359	29	7309
S(n+37)	449	839	4603
Sum	8134	45387	3460853

**Table 14. Smarandache Function
20-20 additive relationships**

n	#1 97573	#2 280200	#2 456829	#3 569793	#4 861971
S(n)	263	467	7489	631	3407
S(n+1)	48787	7573	4153	284897	659
S(n+2)	1301	829	263	1373	6481
S(n+3)	12197	1213	83	461	430987
S(n+4)	97577	70051	35141	569797	1277
S(n+5)	139	56041	149	284899	107747
S(n+6)	97579	5189	91367	63311	861977
S(n+7)	41	280207	6011	37	257
S(n+8)	2957	211	89	9341	861979
S(n+9)	503	131	228419	4129	131
S(n+10)	97583	4003	12347	827	287327
S(n+11)	107	311	47	853	39181
S(n+12)	673	1229	349	37987	4513
S(n+13)	827	3547	228421	16759	73
S(n+14)	1549	271	773	81401	10141
S(n+15)	787	479	631	1319	13903
S(n+16)	4243	35027	91369	569809	41047
S(n+17)	3253	40031	5857	2999	215497
S(n+18)	7507	46703	14737	557	23297
S(n+19)	1109	280219	4079	142453	487
Sum	378982	833732	731774	2073840	2910368
S(n+20)	32531	14011	2207	569813	1087
S(n+21)	6971	93407	9137	13567	107
S(n+22)	149	140111	991	113963	8707
S(n+23)	2711	280223	3461	5479	2677
S(n+24)	5741	139	1117	63313	172399
S(n+25)	48799	1019	228427	6949	2477
S(n+26)	32533	839	229	569819	861997
S(n+27)	61	3221	57107	9497	430999
S(n+28)	191	317	5783	401	287333
S(n+29)	16267	280229	1493	439	431
S(n+30)	467	9341	311	11173	123143
S(n+31)	1877	43	431	17807	313
S(n+32)	241	1523	152287	991	2311
S(n+33)	1319	107	32633	31657	137
S(n+34)	97607	2297	1013	7213	57467
S(n+35)	83	1367	4759	433	1471
S(n+36)	97609	193	91373	769	8369
S(n+37)	227	3947	7877	56983	733
S(n+38)	32537	541	16921	569831	862009
S(n+39)	1061	857	114217	23743	86201
Sum	378982	833732	731774	2073840	2910368

Table 15. Smarandache Function 21-21 additive relationships

n	#1 1477852
S(n)	6971
S(n+1)	1439
S(n+2)	317
S(n+3)	295571
S(n+4)	46183
S(n+5)	492619
S(n+6)	38891
S(n+7)	2459
S(n+8)	24631
S(n+9)	1129
S(n+10)	971
S(n+11)	5297
S(n+12)	184733
S(n+13)	181
S(n+14)	18947
S(n+15)	34369
S(n+16)	1123
S(n+17)	16987
S(n+18)	147787
S(n+19)	1477871
S(n+20)	311
Sum	2798787
S(n+21)	4259
S(n+22)	738937
S(n+23)	563
S(n+24)	369469
S(n+25)	77783
S(n+26)	14489
S(n+27)	113683
S(n+28)	36947
S(n+29)	164209
S(n+30)	105563
S(n+31)	134353
S(n+32)	1151
S(n+33)	4049
S(n+34)	269
S(n+35)	492629
S(n+36)	251
S(n+37)	30161
S(n+38)	16421
S(n+39)	677
S(n+40)	293
S(n+41)	492631
Sum	2798787

Table 16. Smarandache Function 22-22 additive relationships

n	#1 976	#2 61156	#3 2554732	#4 4279047
S(n)	61	15289	127	1831
S(n+1)	977	2659	2554733	2131
S(n+2)	163	10193	4679	13759
S(n+3)	89	8737	853	257
S(n+4)	14	139	159671	611293
S(n+5)	109	37	1693	1303
S(n+6)	491	577	1277369	83903
S(n+7)	983	1973	6277	5309
S(n+8)	41	1699	83	77801
S(n+9)	197	941	193	373
S(n+10)	29	257	11719	4279057
S(n+11)	47	20389	50093	137
S(n+12)	19	3823	319343	11057
S(n+13)	43	61169	5741	213953
S(n+14)	11	2039	425791	80737
S(n+15)	991	83	196519	713177
S(n+16)	31	373	3967	4279063
S(n+17)	331	971	283861	534883
S(n+18)	71	419	929	491
S(n+19)	199	2447	62311	353
S(n+20)	83	2549	6653	3259
S(n+21)	997	467	2554753	281
Sum	5977	137230	7927358	10914408
S(n+22)	499	181	8573	4279069
S(n+23)	37	20393	839	25171
S(n+24)	15	23	638689	3557
S(n+25)	13	317	2554757	2729
S(n+26)	167	103	141931	2441
S(n+27)	59	61	59	1249
S(n+28)	251	239	51	171163
S(n+29)	67	4079	77417	6563
S(n+30)	503	30593	199	43223
S(n+31)	53	8741	2554763	2139539
S(n+32)	7	5099	212897	611297
S(n+33)	1009	1423	773	211
S(n+34)	101	211	7649	8089
S(n+35)	337	523	94621	2139541
S(n+36)	23	7649	159673	1426361
S(n+37)	1013	5563	2417	9467
S(n+38)	26	47	85159	1453
S(n+39)	29	12239	401	33961
S(n+40)	127	15299	1873	6803
S(n+41)	113	20399	5039	593
S(n+42)	509	827	1277387	349
S(n+43)	1019	3221	102191	1579
Sum	5977	137230	7927358	10914408

Table 17. Smarandache Function 23-23 additive relationships

n	#1 587	#2 993	#3 43637	#4 58186	#5 2471860	#6 9908628
S(n)	587	331	3967	619	123593	7717
S(n+1)	14	71	1039	1877	353123	9908629
S(n+2)	31	199	151	373	21683	643
S(n+3)	59	83	1091	58189	2471863	9743
S(n+4)	197	997	373	46	5237	1531
S(n+5)	37	499	21821	163	211	367
S(n+6)	593	37	2297	3637	1235933	857
S(n+7)	11	15	3637	58193	46639	701
S(n+8)	17	13	43	61	577	2477159
S(n+9)	149	167	157	113	2471869	89
S(n+10)	199	59	14549	14549	1637	3253
S(n+11)	23	251	31	1021	373	58631
S(n+12)	599	67	43649	4157	2971	983
S(n+13)	10	503	97	58199	85237	31657
S(n+14)	601	53	43651	97	4079	4954321
S(n+15)	43	7	1559	37	113	6619
S(n+16)	67	1009	14551	29101	56179	2477161
S(n+17)	151	101	73	223	30517	18181
S(n+18)	22	337	8731	14551	39869	150131
S(n+19)	101	23	107	1663	107473	14593
S(n+20)	607	1013	293	109	20599	1667
S(n+21)	19	26	263	58207	130099	821
S(n+22)	29	29	14	107	461	198173
Sum	4166	5890	162144	305292	7210335	20323627
S(n+23)	61	127	59	19403	823961	9908651
S(n+24)	47	113	43661	5821	617971	3343
S(n+25)	17	509	383	58211	2237	430811
S(n+26)	613	1019	929	14	1543	79
S(n+27)	307	17	2729	2531	224717	9049
S(n+28)	41	1021	71	2239	154493	1471
S(n+29)	11	73	3119	3881	117709	14767
S(n+30)	617	31	3359	383	6029	919
S(n+31)	103	12	1213	58217	18043	6143
S(n+32)	619	41	43669	313	205991	495433
S(n+33)	31	19	397	8317	4519	471841
S(n+34)	23	79	14557	71	1235947	137
S(n+35)	311	257	103	6469	337	21401
S(n+36)	89	21	367	677	1193	2281
S(n+37)	13	103	251	79	233	152441
S(n+38)	20	1031	1747	1213	67	4954333
S(n+39)	313	43	179	137	2471899	8669
S(n+40)	19	1033	211	4159	1301	607
S(n+41)	157	47	21839	1493	823967	22571
S(n+42)	37	23	1409	14557	109	330289
S(n+43)	7	37	13	58229	827	30677
S(n+44)	631	61	38	647	2861	154823
S(n+45)	79	173	21841	58231	494381	3302891
Sum	4166	5890	162144	305292	7210335	20323627

Table 18. Smarandache Function 24-24 additive relationships

n	#1 6350	#2 56317
S(n)	127	283
S(n+1)	73	971
S(n+2)	397	18773
S(n+3)	6353	12
S(n+4)	353	3313
S(n+5)	41	149
S(n+6)	227	373
S(n+7)	163	14081
S(n+8)	34	751
S(n+9)	6359	28163
S(n+10)	53	79
S(n+11)	6361	2347
S(n+12)	3181	619
S(n+13)	101	131
S(n+14)	43	569
S(n+15)	67	14083
S(n+16)	1061	56333
S(n+17)	6367	229
S(n+18)	199	593
S(n+19)	193	503
S(n+20)	14	211
S(n+21)	277	1657
S(n+22)	59	1063
S(n+23)	6373	313
Sum	38476	145599
S(n+24)	3187	547
S(n+25)	17	197
S(n+26)	797	2683
S(n+27)	911	7043
S(n+28)	1063	191
S(n+29)	6379	9391
S(n+30)	29	67
S(n+31)	709	14087
S(n+32)	3191	2087
S(n+33)	491	23
S(n+34)	19	1523
S(n+35)	1277	587
S(n+36)	103	109
S(n+37)	2129	1483
S(n+38)	1597	34
S(n+39)	6389	193
S(n+40)	71	97
S(n+41)	83	101
S(n+42)	47	56359
S(n+43)	2131	1409
S(n+44)	139	18787
S(n+45)	1279	28181
S(n+46)	41	359
S(n+47)	6397	61
Sum	38476	145599

Table 19. Smarandache Function 25-25 additive relationships

n	#1 27403	#2 36682	#3 339846
S(n)	409	18341	4357
S(n+1)	31	36683	19991
S(n+2)	29	1019	1847
S(n+3)	193	29	307
S(n+4)	27407	83	971
S(n+5)	571	1747	11719
S(n+6)	27409	2293	223
S(n+7)	2741	1931	577
S(n+8)	9137	1223	677
S(n+9)	89	36691	163
S(n+10)	347	9173	1931
S(n+11)	1523	151	1033
S(n+12)	5483	2621	239
S(n+13)	149	179	2011
S(n+14)	37	139	16993
S(n+15)	13709	36697	113287
S(n+16)	3917	311	1559
S(n+17)	457	941	339863
S(n+18)	1613	367	34
S(n+19)	13711	107	673
S(n+20)	277	2039	169933
S(n+21)	857	127	3433
S(n+22)	1097	37	84967
S(n+23)	653	2447	2281
S(n+24)	27427	18353	11329
Sum	139273	173729	790398
S(n+25)	6857	71	2111
S(n+26)	223	23	43
S(n+27)	211	36709	587
S(n+28)	27431	3671	169937
S(n+29)	127	4079	2719
S(n+30)	3919	353	1049
S(n+31)	43	36713	4787
S(n+32)	59	211	2207
S(n+33)	57	1049	409
S(n+34)	27437	137	293
S(n+35)	269	12239	19993
S(n+36)	1193	1669	1531
S(n+37)	21	503	1201
S(n+38)	3049	17	2741
S(n+39)	13721	36721	83
S(n+40)	2111	61	169943
S(n+41)	2287	12241	339887
S(n+42)	499	9181	97
S(n+43)	13723	113	106
S(n+44)	1307	6121	829
S(n+45)	73	1933	89
S(n+46)	27449	4591	199
S(n+47)	61	53	757
S(n+48)	283	3673	821
S(n+49)	6863	1597	67979
Sum	139273	173729	790398

Table 20. Smarandache Function 26-26 additive relationships

n	#1 89	#2 8850
S(n)	89	59
S(n+1)	6	167
S(n+2)	13	2213
S(n+3)	23	227
S(n+4)	31	233
S(n+5)	47	23
S(n+6)	19	41
S(n+7)	8	521
S(n+8)	97	103
S(n+9)	14	2953
S(n+10)	11	443
S(n+11)	10	8861
S(n+12)	101	211
S(n+13)	17	8863
S(n+14)	103	277
S(n+15)	13	197
S(n+16)	7	31
S(n+17)	53	8867
S(n+18)	107	739
S(n+19)	9	181
S(n+20)	109	887
S(n+21)	11	2957
S(n+22)	37	1109
S(n+23)	7	467
S(n+24)	113	29
S(n+25)	19	71
Sum	1074	40730
S(n+26)	23	317
S(n+27)	29	269
S(n+28)	13	193
S(n+29)	59	683
S(n+30)	17	37
S(n+31)	5	107
S(n+32)	22	4441
S(n+33)	61	47
S(n+34)	41	2221
S(n+35)	31	1777
S(n+36)	15	1481
S(n+37)	7	8887
S(n+38)	127	101
S(n+39)	8	2963
S(n+40)	43	127
S(n+41)	13	523
S(n+42)	131	19
S(n+43)	11	8893
S(n+44)	19	4447
S(n+45)	67	593
S(n+46)	9	139
S(n+47)	17	41
S(n+48)	137	1483
S(n+49)	23	809
S(n+50)	139	89
S(n+51)	7	43
Sum	1074	40730

7, Rue du Sergent Blandan
92130 Issy les Moulineaux, France

REMARKS ON SOME OF THE SMARANDACHE'S PROBLEMS. Part 1

Krassimir T. Atanassov

CLBME - Bulgarian Academy of Sciences

Bulgaria, Sofia-1113, P.O.Box 12

e-mail: krat@bgcict.acad.bg

In 1996 the author of this remarks wrote reviews for "Zentralblatt für Mathematik" for books [1] and [2] and this was his first contact with the Smarandache's problems. He solved some of them and he published his solutions in [3]. The present paper contains some of the results from [3].

In [1] Florentin Smarandache formulated 105 unsolved problems, while in [2] C. Dumitrescu and V. Seleacu formulated 140 unsolved problems of his. The second book contains almost all the problems from [1], but now each problem has unique number and by this reason the author will use the numeration of the problems from [2]. Also, in [2] there are some problems, which are not included in [1].

When the text of [3] was ready, the author received Charles Ashbacher's book [4] and he corrected a part of the prepared results having in mind [4].

We shall use the usual notations: $[x]$ and $\lceil x \rceil$ for the integer part of the real number x and for the least integer $\geq x$, respectively.

The 4-th problem from [2] (see also 18-th problem from [1]) is the following:

Smarandache's deconstructive sequence:

1, 23, 456, 7891, 23456, 789123, 4567891, 23456789, 123456789, ...

Let the n -th term of the above sequence be a_n . Then we can see that the first digits of the first nine members are, respectively: 1, 2, 4, 7, 2, 7, 4, 2, 1. Let us define the function ω as follows:

$$\begin{array}{r|cccccccc} r & 0 & 1 & 2 & 3 & 4 & 5 & 6 & 7 & 8 & 9 \\ \omega(r) & 1 & 1 & 2 & 4 & 7 & 2 & 7 & 4 & 2 & 1 \end{array}$$

Here we shall use the arithmetic function ψ , discussed shortly in the Appendix and detailed in the author's paper [5].

In [3] it is proved that the form of the n -th member of the above sequence is

$$a_n = \overline{b_1 b_2 \dots b_n},$$

where

$$\begin{aligned} b_1 &= \omega(n - [\frac{n}{9}]) \\ b_2 &= \psi(\omega(n - [\frac{n}{9}]) + 1) \\ &\dots \\ b_n &= \psi(\omega(n - [\frac{n}{9}]) + n - 1). \end{aligned}$$

To the above sequence $\{a_n\}_{n=1}^{\infty}$ we can juxtapose the sequence $\{\psi(a_n)\}_{n=1}^{\infty}$ for which

we can prove (as above) that its basis is $[1, 5, 6, 7, 2, 3, 4, 8, 9]$.

The problem can be generalized, e.g., to the following form:

Study the sequence $\{a_n\}_{n=1}^{\infty}$, with its s -th member of the form

$$a_s = \overline{b_1 b_2 \dots b_{s,k}},$$

where $b_1 b_2 \dots b_{s,k} \in \{1, 2, \dots, 9\}$ and

$$\begin{aligned} b_1 &= \omega'(s - [\frac{s}{9}]) \\ b_2 &= \psi(\omega'(s - [\frac{s}{9}]) + 1) \\ &\dots \\ b_{s,k} &= \psi(\omega'(s - [\frac{s}{9}]) + s.k - 1), \end{aligned}$$

and here

$$\begin{array}{r|cccccc} r & 1 & 2 & 3 & 4 & 5 & 6 \\ \omega(r) & 1 & \psi(k+1) & \psi(3k+1) & \psi(6k+1) & \psi(10k+1) & \psi(15k+1) \end{array}$$

$$\begin{array}{r|ccc} r & 7 & 8 & 9 \\ \omega(r) & \psi(21k+1) & \psi(28k+1) & \psi(36k+1) \end{array}$$

To the last sequence $\{a_n\}_{n=1}^{\infty}$ we can juxtapose again the sequence $\{\psi(a_n)\}_{n=1}^{\infty}$ for which we can prove (as above) that its basis is $[3, 9, 3, 6, 3, 6, 9, 8, 9]$.

The 16-th problem from [2] (see also 21-st problem from [1]) is the following:

Digital sum:

$$\begin{aligned} & \underbrace{0, 1, 2, 3, 4, 5, 6, 7, 8, 9}, \underbrace{1, 2, 3, 4, 5, 6, 7, 8, 9, 10}, \underbrace{2, 3, 4, 5, 6, 7, 8, 9, 10, 11}, \\ & \underbrace{3, 4, 5, 6, 7, 8, 9, 10, 11, 12}, \underbrace{4, 5, 6, 7, 8, 9, 10, 11, 12, 13}, \underbrace{5, 6, 7, 8, 9, 10, 11, 12, 13, 14}, \dots \end{aligned}$$

($d_s(n)$ is the sum of digits.) Study this sequence.

The form of the general term a_n of the sequence is:

$$a_n = n - 9 \cdot \sum_{k=1}^{\infty} \left[\frac{n}{10^k} \right].$$

It is not always true that equality $d_s(m) + d_s(n) = d_s(m+n)$ is valid. For example,

$$d_s(2) + d_s(3) = 2 + 3 = 5 = d_s(5),$$

but

$$d_s(52) + d_s(53) = 7 + 8 = 15 \neq 6 = d_s(105).$$

The following assertion is true

$$d_s(m+n) = \begin{cases} d_s(m) + d_s(n), & \text{if } d_s(m) + d_s(n) \leq 9 \cdot \max\left(\left[\frac{d_s(m)}{9}\right], \left[\frac{d_s(n)}{9}\right]\right) \\ d_s(m) + d_s(n) - 9 \cdot \max\left(\left[\frac{d_s(m)}{9}\right], \left[\frac{d_s(n)}{9}\right]\right), & \text{otherwise} \end{cases}$$

The sum of the first n members of the sequence is

$$S_n = 5 \cdot \left[\frac{n}{10} \right] \cdot \left(\left[\frac{n}{10} \right] + 8 \right) + (n - 10 \cdot \left[\frac{n}{10} \right]) \cdot \left(\frac{n-1}{2} - 4 \cdot \left[\frac{n}{10} \right] \right).$$

The 37-th and 38-th problems from [2] (see also 39-th problem from [1]) are the following:

(Inferior) prime part:

2, 3, 3, 5, 5, 7, 7, 7, 7, 11, 11, 13, 13, 13, 13, 17, 17, 19, 19, 19, 19, 23, 23, 23, 23, 23, 23, 29, 29, 31,

31, 31, 31, 31, 31, 37, 37, 37, 37, 41, 41, 43, 43, 43, 43, 47, 47, 47, 47, 47, 47, 53, 53, 53, 53, 53, ...

(For any positive real number n one defines $p_p(n)$ as the largest prime number less than or equal to n .)

(Superior) prime part:

2, 2, 2, 3, 5, 5, 7, 7, 11, 11, 11, 11, 13, 13, 17, 17, 17, 17, 19, 19, 23, 23, 23, 23, 29, 29, 29, 29, 29, 29, 31, 31, 37, 37, 37, 37, 37, 37, 41, 41, 41, 41, 43, 43, 47, 47, 47, 47, 53, 53, 53, 53, 53, 53, 59, 59, ...

(For any positive real number n one defines $P_p(n)$ as the smallest prime number greater than or equal to n .)

Study these sequences.

First, we should note that in the first sequence $n \geq 2$, while in the second one $n \geq 0$. It would be better, if the first two members of the second sequence are omitted. Let everywhere below $n \geq 2$.

Second, let us denote by

$$\{p_1, p_2, p_3, \dots\} = \{2, 3, 5, \dots\},$$

the set of all prime numbers. Let $p_0 = 1$, and let $\pi(n)$ be the number of the prime numbers less or equal to n .

Then the n -th member of the first sequence is

$$p_p(n) = p_{\pi(n)-1}$$

and of the second sequence is

$$P_p(n) = p_{\pi(n)+\mathcal{B}(n)},$$

where

$$\mathcal{B}(n) = \begin{cases} 0, & \text{if } n \text{ is a prime number} \\ 1, & \text{otherwise} \end{cases}$$

(see [7]).

The checks of these equalities are straightforward, or by induction.

Therefore, the values of the n -th partial sums of the two sequences are, respectively,

$$X_n = \sum_{k=1}^n p_p(k) = \sum_{k=2}^{\pi(n)} (p_k - p_{k-1}) \cdot p_{k-1} + (n - p_{\pi(n)} + 1) \cdot p_{\pi(n)}$$

$$Y_n = \sum_{k=1}^n P_p(k) = \sum_{k=1}^{\pi(n)} (p_k - p_{k-1}) \cdot p_k + (n - p_{\pi(n)}) \cdot p_{\pi(n) + \mathcal{B}(n)}.$$

The 39-th and 40-th problems from [2] (see also 40-th problem from [1]) are the following:
(Inferior) square part:

0, 1, 1, 1, 4, 4, 4, 4, 4, 9, 9, 9, 9, 9, 9, 9, 9, 16, 16, 16, 16, 16, 16, 16, 16, 16, 16, 25, 25, 25, 25, 25, 25,
 25, 25, 25, 25, 25, 36, 36, 36, 36, 36, 36, 36, 36, 36, 36, 36, 36, 36, 36, 36, 36, 49, 49, ...

(the largest square less than or equal to n.)

(Superior) square part:

0, 1, 4, 4, 4, 9, 9, 9, 9, 9, 16, 16, 16, 16, 16, 16, 16, 16, 25, 25, 25, 25, 25, 25,
 25, 25, 25, 36, 36, 36, 36, 36, 36, 36, 36, 36, 36, 36, 36, 36, 36, 36, 49, 49, ...

(the smallest square greater than or equal to n.) Study these sequences.

The 41-st and 42-nd problems from [1] (see also 41-st problem from [1]) are the following:
(Inferior) cube part:

0, 1, 1, 1, 1, 1, 1, 1, 8, 27, 27, 27, 27, 27, 27, 27, 27, 27, ...

(the largest cube less than or equal to n.)

(Superior) cube part:

0, 1, 8, 8, 8, 8, 8, 8, 8, 27, 64, ...

(the smallest cube greater than or equal to n.) Study these sequences.

The n -th term of each of the above sequences is, respectively

$$a_n = [\sqrt{n}]^2, \quad b_n = \lceil \sqrt{n} \rceil^2, \quad c_n = [\sqrt[3]{n}]^3, \quad d_n = \lceil \sqrt[3]{n} \rceil^3.$$

The values of the n -th partial sums of these sequences are:

$$A_n = \frac{[\sqrt{n} - 1]([\sqrt{n} - 1] + 1)(3[\sqrt{n} - 1]^2 + 5[\sqrt{n} - 1] + 1)}{6} + (n - [\sqrt{n}]^2 + 1) \cdot [\sqrt{n}]^2,$$

$$B_n = \frac{[\sqrt{n}]([\sqrt{n}] + 1)(3[\sqrt{n}]^2 + [\sqrt{n}] - 1)}{6} + (n - [\sqrt{n}]^2) \cdot [\sqrt{n}]^2,$$

$$C_n = \frac{[\sqrt[3]{n}-1]([\sqrt[3]{n}-1]+1)(5[\sqrt[3]{n}-1]^4+16[\sqrt[3]{n}-1]^3)}{10}$$

$$+ \frac{14[\sqrt[3]{n}-1]^2 + [\sqrt[3]{n}-1] - 1}{10} + (n - [\sqrt[3]{n}]^3 + 1) \cdot [\sqrt[3]{n}]^3,$$

$$D_n = \frac{[\sqrt[3]{n}]([\sqrt[3]{n}] + 1)(5[\sqrt[3]{n}]^4 + 4[\sqrt[3]{n}]^3 - 4[\sqrt[3]{n}]^2 - [\sqrt[3]{n}] + 1)}{10} (n - [\sqrt[3]{n}]^3 + 1) \cdot [\sqrt[3]{n}]^3.$$

The 43-rd and 44-th problems from [2] (see also 42-nd problem from [1]) are the following:
(Inferior) factorial part:

1, 2, 2, 2, 2, 6, 6, 6, 6, 6, 6, 6, 6, 6, 6, 6, 6, 6, 6, 6, 6, 6, 24, 24, 24, 24, 24, 24, 24, 24, 24, 24, ...

($F_p(n)$ is the largest factorial less than or equal to n .)

(Superior) factorial part:

1, 2, 6, 6, 6, 6, 24, 24, 24, 24, 24, 24, 24, 24, 24, 24, 24, 24, 24, 24, 24, 24, 24, 24, 120, ...

($f_p(n)$ is the smallest factorial greater than or equal to n .) Study these sequences.

It must be noted immediately that p is not an index in F_p and f_p .

First, we shall extend the definition of the function “factorial” (possibly, it is already defined, but the author does not know this). It is defined only for natural numbers and for a given such number n it has the form:

$$n! = 1.2. \dots .n.$$

Let the new form of the function “factorial” be the following for the real positive number y :

$$y! = y.(y-1).(y-2)\dots(y-[y]+1),$$

where $[y]$ denotes the integer part of y .

Therefore, for the real number $y > 0$:

$$(y + 1)! = y! \cdot (y + 1).$$

This new factorial has Γ -representation

$$y! = \frac{\Gamma(y + 1)}{\Gamma(y - [y] + 1)}$$

and representation by the Pochhammer symbol

$$y! = (y)_{[y]}$$

(see, e.g., [8]).

Obviously, if y is a natural number, $y!$ is the standard function “factorial”.

It can be easily seen that the extended function has the properties similar to these of the standard function.

Second, we shall define a new function (possibly, it is already defined, too, but the author does not know this). It is an inverse function of the function “factorial” and for the arbitrary positive real numbers x and y it has the form:

$$x? = y \text{ iff } y! = x.$$

Let us show only one of its integer properties.

For every positive real number x :

$$[(x + 1)?] = \begin{cases} [x?] + 1, & \text{if there exists a natural number } n \text{ such} \\ & \text{that } n! = x + 1 \\ [x?], & \text{otherwise} \end{cases}$$

From the above discussion it is clear that we can ignore the new factorial, using the definition

$$x? = y \text{ iff } (y)_{[y]} = x.$$

Practically, everywhere below y is a natural number, but at some places x will be a positive real number (but not an integer).

Then the n -th member of the first sequence is

$$F_p(n) = [n?]$$

and of the second sequence it is

$$f_p(n) = \lceil n^? \rceil!$$

The checks of these equalities is direct, or by the method of induction.

Therefore, the values of the n -th partial sums of the two above Smarandache's sequences are, respectively,

$$X_n = \sum_{k=1}^n F_p(k) = \sum_{k=1}^{\lceil n^? \rceil} (k! - (k-1)!).(k-1)! + (n - \lceil n^? \rceil + 1).\lceil n^? \rceil!$$

$$Y_n = \sum_{k=1}^n f_p(k) = \sum_{k=1}^{\lceil n^? \rceil} (k! - (k-1)!).k! + (n - \lceil n^? \rceil + 1).\lceil n^? \rceil!$$

The 100-th problem from [2] (see also 80-th problem from [1]) is the following:

Square roots:

$$0, 1, 1, 1, 2, 2, 2, 2, 2, 3, 3, 3, 3, 3, 3, 3, 4, 4, 4, 4, 4, 4, 4, 4, 4, 4, 5, 5, 5, 5, 5, 5, \dots$$

($s_q(n)$ is the superior integer part of square root of n .)

Remark: this sequence is the natural sequence, where each number is repeated $2n + 1$ times, because between n^2 (included) and $(n+1)^2$ (excluded) there are $(n+1)^2 - n^2$ different numbers.

Study this sequence.

The 101-st problem from [2] (see also 81-st problem from [1]) is the following:

Cubical roots:

$$0, 1, 1, 1, 1, 1, 1, 1, 2, 3, 3, 3, 3, 3, \dots$$

($c_q(n)$ is the superior integer part of cubical root of n .)

Remark: this sequence is the natural sequence, where each number is repeated $3n^2 + 3n + 1$ times, because between n^3 (included) and $(n+1)^3$ (excluded) there are $(n+1)^3 - n^3$ different numbers.

Study this sequence.

The 102-nd problem from [2] (see also 82-nd problem from [1]) is the following:

m-power roots:

($m_q(n)$ is the superior integer part of m -power root of n .)

Remark: this sequence is the natural sequence, where each number is repeated $(n+1)^m - n^m$ times.

Study this sequence.

The n -th term of each of the above sequences is, respectively,

$$x_n = [\sqrt{n}], \quad y_n = [\sqrt[3]{n}], \quad z_n = [\sqrt[m]{n}]$$

and the values of the n -th partial sums are, respectively,

$$X_n = \sum_{k=1}^n x_k = \frac{([\sqrt{n}] - 1)[\sqrt{n}](4[\sqrt{n}] + 1)}{6} + n - [\sqrt{n}]^2 + 1) \cdot [\sqrt{n}],$$

$$Y_n = \sum_{k=1}^n y_k = \frac{([\sqrt[3]{n}] - 1)[\sqrt[3]{n}]^2(3[\sqrt[3]{n}] + 1)}{4} + (n - [\sqrt[3]{n}]^3 + 1) \cdot [\sqrt[3]{n}],$$

$$Z_n = \sum_{k=1}^n z_k = \sum_{k=1}^n (([\sqrt[m]{k}] + 1)^m - [\sqrt[m]{k}]^m)[\sqrt[m]{k} - 1]^m + (n - [\sqrt[m]{n}]^m + 1) \cdot [\sqrt[m]{n}].$$

The 118-th Smarandache's problem (see [2]) is:

"Smarandache's criterion for coprimes":

If a, b are strictly positive integers, then: a and b are coprimes if and only if

$$a^{\varphi(b)+1} + b^{\varphi(a)+1} \equiv a + b \pmod{ab},$$

where φ is Euler's totient.

For the natural number

$$n = \prod_{i=1}^k p_i^{\alpha_i},$$

where p_1, p_2, \dots, p_k are different prime numbers and $\alpha_1, \alpha_2, \dots, \alpha_k \geq 1$ are natural numbers, the Euler's totient is defined by:

$$\varphi(n) = \prod_{i=1}^k p_i^{\alpha_i-1} \cdot (p_i - 1).$$

Below we shall introduce a solution of one direction of this problem and we shall introduce a counterexample to the other direction of the problem.

Let a, b be strictly positive integers for which $(a, b) = 1$. Hence, from one of the Euler's theorems:

If m and n are natural numbers and $(m, n) = 1$, then

$$m^{\varphi(n)} \equiv 1 \pmod{n}$$

(see, e.g., [6]) it follows that

$$a^{\varphi(b)} \equiv 1 \pmod{b}$$

and

$$b^{\varphi(a)} \equiv 1 \pmod{a}.$$

Therefore,

$$a^{\varphi(b)+1} \equiv a \pmod{ab}$$

and

$$b^{\varphi(a)+1} \equiv b \pmod{ab}$$

from where it follows that really

$$a^{\varphi(b)+1} + b^{\varphi(a)+1} \equiv a + b \pmod{ab}.$$

It can be easily seen that the other direction of the Smarandache's problem is not valid. For example, if $a = 6$ and $b = 10$, and, therefore, $(a, b) = 2$, then:

$$6^{\varphi(10)+1} + 10^{\varphi(6)+1} = 6^5 + 10^3 = 7776 + 1000 = 8776 \equiv 16 \pmod{60}.$$

Therefore, the "Smarandache's criterion for coprimes" is valid only in the form:

If a, b are strictly positive coprime integers, then

$$a^{\varphi(b)+1} + b^{\varphi(a)+1} \equiv a + b \pmod{ab}.$$

The 125-th Smarandache's problem (see [2]) is the following:

To prove that

$$n! > k^{n-k+1} \prod_{i=0}^{k-1} \left[\frac{n-i}{k} \right]! \quad (*)$$

for any non-null positive integers n and k .

Below we shall introduce a solution to the problem.

First, let us define for every negative integer m : $m! = 0$.

Let everywhere k be a fixed natural number. Obviously, if for some n : $k > n$, then the inequality (*) is obvious, because its right side is equal to 0. Also, it can be easily seen that (*) is valid for $n = 1$. Let us assume that (*) is valid for some natural number n . Then,

$$(n+1)! - k^{n-k+2} \prod_{i=0}^{k-1} \left[\frac{n-i+1}{k} \right]!$$

(by the induction assumption)

$$\begin{aligned} &> (n+1) \cdot k^{n-k+1} \prod_{i=0}^{k-1} \left[\frac{n-i}{k} \right]! - k^{n-k+2} \prod_{i=0}^{k-1} \left[\frac{n-i+1}{k} \right]! \\ &= k^{n-k+1} \prod_{i=0}^{k-2} \left[\frac{n-i}{k} \right]! \cdot \left((n+1) \cdot \left[\frac{n-k+1}{k} \right]! - k \cdot \left[\frac{n+1}{k} \right]! \right) \geq 0, \end{aligned}$$

because

$$\begin{aligned} &(n+1) \cdot \left[\frac{n-k+1}{k} \right]! - k \cdot \left[\frac{n+1}{k} \right]! \\ &= (n+1) \cdot \left[\frac{n-k+1}{k} \right]! - k \cdot \left[\frac{n-k+1}{k} + 1 \right]! \\ &= \left[\frac{n-k+1}{k} \right]! \cdot (n+1 - k \cdot \left[\frac{n+1}{k} \right]) \geq 0. \end{aligned}$$

Thus the problem is solved.

Finally, we shall formulate two new problems:

1. Let $y > 0$ be a real number and let k be a natural number. Will the inequality

$$y! > k^{y-k+1} \prod_{i=0}^{k-1} \left[\frac{y-i}{k} \right]!$$

be valid again?

2. For the same y and k will the inequality

$$y! > k^{y-k+1} \prod_{i=0}^{k-1} \frac{y-i}{k}!$$

be valid?

The paper and the book [3] are based on the author's papers [9-16].

APPENDIX

Here we shall describe two arithmetic functions which were used below, following [5].

For

$$n = \sum_{i=1}^m a_i \cdot 10^{m-i} \equiv \overline{a_1 a_2 \dots a_m},$$

where a_i is a natural number and $0 \leq a_i \leq 9$ ($1 \leq i \leq m$) let (see [5]):

$$\varphi(n) = \begin{cases} 0 & , \text{ if } n = 0 \\ \sum_{i=1}^m a_i & , \text{ otherwise} \end{cases}$$

and for the sequence of functions $\varphi_0, \varphi_1, \varphi_2, \dots$, where (l is a natural number)

$$\varphi_0(n) = n,$$

$$\varphi_{l+1} = \varphi(\varphi_l(n)),$$

let the function ψ be defined by

$$\psi(n) = \varphi_l(n),$$

in which

$$\varphi_{l+1}(n) = \varphi_l(n).$$

This function has the following (and other) properties (see [5]):

$$\psi(m+n) = \psi(\psi(m) + \psi(n)),$$

$$\psi(m.n) = \psi(\psi(m).\psi(n)) = \psi(m.\psi(n)) = \psi(\psi(m).n),$$

$$\psi(m^n) = \psi(\psi(m)^n),$$

$$\psi(n+9) = \psi(n),$$

$$\psi(9n) = 9.$$

Let the sequence a_1, a_2, \dots with members - natural numbers, be given and let

$$c_i = \psi(a_i) \quad (i = 1, 2, \dots).$$

Hence, we deduce the sequence c_1, c_2, \dots from the former sequence. If k and l exist, so that $l \geq 0$,

$$c_{i+l} = c_{k+i+l} = c_{2k+i+l} = \dots$$

for $1 \leq i \leq k$, then we shall say that

$$[c_{l+1}, c_{l+2}, \dots, c_{l+k}]$$

is a base of the sequence c_1, c_2, \dots with a length of k and with respect to function ψ .

For example, the Fibonacci sequence $\{F_i\}_{i=0}^{\infty}$, for which

$$F_0 = 0, F_1 = 1, F_{n+2} = F_{n+1} + F_n \quad (n \geq 0)$$

has a base with a length of 24 with respect to the function ψ and it is the following:

$$[1, 1, 2, 3, 5, 8, 4, 3, 7, 1, 8, 9, 8, 8, 7, 6, 4, 1, 5, 6, 2, 8, 1, 9];$$

the Lucas sequence $\{L_i\}_{i=0}^{\infty}$, for which

$$L_2 = 2, L_1 = 1, L_{n+2} = L_{n+1} + L_n \quad (n \geq 0)$$

also has a base with a length of 24 with respect to the function ψ and it is the following:

$$[2, 1, 3, 4, 7, 2, 9, 2, 2, 4, 6, 1, 7, 8, 6, 5, 2, 7, 9, 7, 7, 5, 3, 8];$$

even the Lucas-Lehmer sequence $\{l_i\}_{i=0}^{\infty}$, for which

$$l_1 = 4, l_{n+1} = l_n^2 - 2 \quad (n \geq 0)$$

has a base with a length of 1 with respect to the function ψ and it is [5].

The k -th triangular number t_k is defined by the formula

$$t_k = \frac{k(k+1)}{2}$$

and it has a base with a length of 9 with the form

$$[1, 3, 6, 1, 5, 3, 1, 9, 9].$$

It is directly checked that the bases of the sequences $\{n^k\}_{k=1}^{\infty}$ for $n = 1, 2, \dots, 9$ are the ones introduced in the following table.

n	a base of a sequence $\{n^k\}_{k=1}^{\infty}$	a length of the base
1	1	1
2	2,4,8,7,5,1	6
3	9	1
4	4,7,1	3
5	5,7,8,4,2,1	6
6	9	1
7	7,4,1	3
8	8,1	2
9	9	1

On the other hand, the sequence $\{n^n\}_{n=1}^{\infty}$ has a base (with a length of 9) with the form

$$[1, 4, 9, 1, 2, 9, 7, 1, 9],$$

and the sequence $\{k^{n!}\}_{n=1}^{\infty}$ has a base with a length of 9 with the form

$$\begin{cases} [1] & , \text{ if } k \neq 3m \text{ for some natural number } m \\ [9] & , \text{ if } k = 3m \text{ for some natural number } m \end{cases}$$

We must note that in [5] there are some misprints, corrected here.

An obvious, but unpublished up to now result is that the sequence $\{\psi(n!)\}_{n=1}^{\infty}$ has a base with a length of 1 with respect to the function ψ and it is [9]. The first members of this sequence are

$$1, 2, 6, 6, 3, 9, 9, 9, \dots$$

We shall finish with two new results related to the concept “factorial” which occur in some places in this book.

The concepts of $n!!$ is already introduced and there are some problems in [1,2] related to it. Let us define the new factorial $n!!!$ only for numbers with the forms $3k + 1$ and $3k + 2$:

$$n!!! = 1.2.4.5.7.8.10.11\dots n$$

We shall prove that the sequence $\{\psi(n!!!)\}_{n=1}^{\infty}$ has a base with a length of 12 with respect to the function ψ and it is

$$[1, 2, 8, 4, 1, 8, 8, 7, 1, 5, 8, 1].$$

Really, the validity of the assertion for the first 12 natural numbers with the above mentioned forms, i.e., the numbers

$$1, 2, 4, 5, 7, 8, 10, 11, 13, 14, 16, 17,$$

is directly checked. Let us assume that the assertion is valid for the numbers

$$(18k + 1)!!!, (18k + 2)!!!, (18k + 4)!!!, (18k + 5)!!!, (18k + 7)!!!, (18k + 8)!!!,$$

$$(18k + 10)!!!, (18k + 11)!!!, (18k + 13)!!!, (18k + 14)!!!, (18k + 16)!!!,$$

$$(18k + 17)!!!.$$

Then

$$\psi((18k + 19)!!!) = \psi((18k + 17)!!!.(18k + 19))$$

$$= \psi(\psi(18k + 17)!!!.\psi(18k + 19))$$

$$= \psi(1.1) = 1;$$

$$\psi((18k + 20)!!!) = \psi((18k + 19)!!!.(18k + 20))$$

$$= \psi(\psi(18k + 19)!!!.\psi(18k + 20))$$

$$\begin{aligned}
&= \psi(1.2) = 2; \\
\psi((18k + 22)!!!) &= \psi((18k + 20)!!!.(18k + 22)) \\
&= \psi(\psi(18k + 20)!!!.\psi(18k + 22)) \\
&= \psi(2.4) = 8,
\end{aligned}$$

etc., with which the assertion is proved.

Having in mind that every natural number has exactly one of the forms $3k + 3$, $3k + 1$ and $3k + 2$, for the natural number $n = 3k + m$, where $m \in \{1, 2, 3\}$ and $k \geq 1$ is a natural number, we can define:

$$n!_m = \begin{cases} 1.4\dots(3k + 1), & \text{if } n = 3k + 1 \text{ and } m = 1 \\ 2.5\dots(3k + 2), & \text{if } n = 3k + 2 \text{ and } m = 2 \\ 3.6\dots(3k + 3), & \text{if } n = 3k + 3 \text{ and } m = 3 \end{cases}$$

As above, we can prove that:

- for the natural number n with the form $3k + 1$, the sequence $\{\psi(n!_1)\}_{n=1}^{\infty}$ has a base with a length of 3 with respect to the function ψ and it is

$$[1, \psi(3k + 1), 1];$$

- for the natural number n with the form $3k + 2$, the sequence $\{\psi(n!_1)\}_{n=1}^{\infty}$ has a base with a length of 6 with respect to the function ψ and it is

$$[2, \psi(6k + 4), 8, 7, \psi(3k + 5), 1];$$

- for the natural number n with the form $3k + 3$, the sequence $\{\psi(n!_1)\}_{n=1}^{\infty}$ has a base with a length of 1 with respect to the function ψ and it is [9] and only its first member is 3.

Now we can see that

$$n!!! = \begin{cases} (3k + 1)!_1.(3k - 1)!_2, & \text{if } n = 3k + 1 \text{ and } k \geq 1 \\ (3k + 1)!_1.(3k + 2)!_2, & \text{if } n = 3k + 2 \text{ and } k \geq 1 \end{cases}$$

REFERENCES:

- [1] F. Smarandache, *Only Problems, Not Solutions!*. Xiquan Publ. House, Chicago, 1993.
- [2] C. Dumitrescu, V. Seleacu, *Some Sotions and Questions in Number Theory*, Erhus Univ. Press, Glendale, 1994.
- [3] Atanassov K., *On Some of the Smarandache's Problems*. American Research Press, Lupton, 1999.
- [4] C. Ashbacher, *Pluckings from the Tree of Smarandache Sequences and Functions*. American Research Press, Lupton, 1998.
- [5] K. Atanassov, An arithmetic function and some of its applications. *Bull. of Number Theory and Related Topics*, Vol. IX (1985), No. 1, 18-27.
- [6] T. Nagell, *Introduction to Number Theory*. John Wiley & Sons, Inc., New York, 1950.
- [7] K. Atanassov, Remarks on prime numbers, *Notes on Number Theory and Discrete Mathematics*, Vol. 2 (1996), No. 4, 49 - 51.
- [8] L. Comtet, *Advanced Combinatorics*, D. Reidel Publ. Co., Dordrecht-Holland, 1974.
- [9] Atanassov K., On the 4-th Smarandache's problem *Notes on Number Theory and Discrete Mathematics*, Vol. 5 (1999), No. 1, 33-35.
- [10] Atanassov K., On the 16-th Smarandache's problem *Notes on Number Theory and Discrete Mathematics*, Vol. 5 (1999), No. 1, 36-38.
- [11] Atanassov K., On the 37-th and the 38-th Smarandache's problems. *Notes on Number Theory and Discrete Mathematics*, Vol. 5 (1999), No. 2, 83-85.
- [12] Radeva V., Atanassov K., On the 40-th and 41-th Smarandache's problems. *Notes on Number Theory and Discrete Mathematics*, Vol. 4 (1998), No. 3, 101-104.
- [13] Atanassova V., K. Atanassov, On the 43-rd and the 44-th Smarandache's problems. *Notes on Number Theory and Discrete Mathematics*, Vol. 5 (1999), No. 2, 86-88.
- [14] Atanassov K., On the 100-th, the 101-st, and the 102-nd Smarandache's problems. *Notes on Number Theory and Discrete Mathematics*, Vol. 5 (1999), No. 3, 94-96.
- [15] Atanassov K., On the 118-th Smarandache's problem. *Notes on Number Theory and Discrete Mathematics*, Vol. 5 (1999), No. 3, 99.
- [16] Atanassov K., On the 125-th Smarandache's problem. *Notes on Number Theory and Discrete Mathematics*, Vol. 5 (1999), No. 3, 124.

A brief account on Smarandache 2-2 subtractive relationships

Henry Ibstedt

Abstract: An analysis of the number of relations of the type $S(n)-S(n+1)=S(n+2)-S(n+3)$ for $n < 10^8$ where $S(n)$ is the Smarandache function leads to the plausible conclusion that there are infinitely many of those.

This brief note on Smarandache 2-2 subtractive relationships should be seen in relation to the article on Smarandache k-k additive relationships in this issue of SNJ [1]. A Smarandache 2-2 subtractive relationship is defined by

$$S(n)-S(n+1)=S(n+2)-S(n+3)$$

where $S(n)$ denotes the Smarandache function. In an article by Bencze [2] three 2-2 subtractive relationships are given

$$S(1)-S(2)=S(3)-S(4), \quad 1-2=3-4$$

$$S(2)-S(3)=S(4)-S(5), \quad 2-3=4-5$$

$$S(49)-S(50)=S(51)-S(52), \quad 14-10=17-13$$

The first of these solutions must be rejected since $S(1)=0$ not 1. The question raised in the article is "How many quadruplets verify a Smarandache 2-2 subtractive relationship?"

As in the case of Smarandache 2-2 additive relationships a search was carried for $n \leq 10^8$. In all 442 solutions were found. The first 50 of these are shown in table 1.

Table 1. The 50 first 2-2 subtractive relations.

#	n	S(n)	S(n+1)	S(n+3)	S(n+4)
1	2	2	3	4	5
2	40	5	41	7	43
3	49	14	10	17	13
4	107	107	9	109	11
5	2315	463	193	331	61
6	3913	43	103	29	89
7	4157	4157	11	4159	13
8	4170	139	97	149	107
9	11344	709	2269	61	1621
10	11604	967	211	829	73
11	11968	17	11969	19	11971
12	13244	43	883	179	1019
13	15048	19	149	43	173
14	19180	137	19181	139	19183
15	19692	547	419	229	101
16	26219	167	23	2017	1873
17	29352	1223	197	1129	103
18	29415	53	3677	1279	4903
19	43015	1229	283	1103	157
20	44358	7393	6337	1109	53
21	59498	419	601	17	199
22	140943	4271	383	4027	139

Table 1. continued.

#	n	S(n)	S(n+1)	S(n+3)	S(n+4)
23	147599	1433	41	2203	811
24	153386	283	23	1237	977
25	169533	23	79	827	883
26	181577	971	571	1697	1297
27	186056	1789	2297	2269	2777
28	201965	1303	821	1453	971
29	204189	2347	2917	139	709
30	210219	887	457	659	229
31	217591	151	461	8059	8369
32	246974	59	89	227	257
33	253672	857	167	829	139
34	257543	1801	73	2711	983
35	262905	1031	211	929	109
36	273815	2381	3803	3299	4721
37	321010	683	821	241	379
38	363653	163	227	283	347
39	407836	31	661	673	1303
40	431575	283	739	607	1063
41	451230	89	127	239	277
42	530452	202	166	419	383
43	549542	2309	2207	941	839
44	573073	2909	2837	283	211
45	589985	631	449	1291	1109
46	590569	353	809	317	773
47	608333	1907	1913	191	197
48	646333	15031	24859	271	10099
49	649702	577	1447	107	977
50	666647	666647	197	666649	199

As in the case of 2-2 additive relations there is a great number of solutions formed by pairs of prime twins.

Table 2. All 51 subtractive relations formed by pairs of prime twins for $n < 10^8$.

#	n	S(n)	S(n+1)	S(n+3)	S(n+4)
1	40	5	41	7	43
2	4157	4157	11	4159	13
3	11968	17	11969	19	11971
4	19180	137	19181	139	19183
5	666647	666647	197	666649	199
6	895157	895157	137	895159	139
7	1695789	347	101	349	103
8	1995526	71	1995527	73	1995529
9	2007880	101	2007881	103	2007883
10	2272547	2272547	149	2272549	151
11	3198730	1787	3198731	1789	3198733
12	3483088	227	3483089	229	3483091
13	3546268	431	3546269	433	3546271
14	4194917	4194917	197	4194919	199

Table 2. Continued.

#	n	S(n)	S(n+1)	S(n+3)	S(n+4)
15	4503640	179	4503641	181	4503643
16	5152420	149	5152421	151	5152423
17	6634078	269	6634079	271	6634081
18	6729658	107	6729659	109	6729661
19	7455628	2729	7455629	2731	7455631
20	7831738	641	7831739	643	7831741
21	7924877	7924877	71	7924879	73
22	11001647	11001647	239	11001649	241
23	11053978	281	11053979	283	11053981
24	12466690	809	12466691	811	12466693
25	13530988	311	13530989	313	13530991
26	17293120	4157	17293121	4159	17293123
27	17424707	17424707	311	17424709	313
28	18173650	191	18173651	193	18173653
29	19222600	431	19222601	433	19222603
30	19227910	419	19227911	421	19227913
31	22208567	22208567	431	22208569	433
32	26037491	26037491	347	26037493	349
33	30468670	311	30468671	313	30468673
34	31815238	5639	31815239	5641	31815241
35	36683147	36683147	641	36683149	643
36	40881257	40881257	191	40881259	193
37	42782236	227	42782237	229	42782239
38	46238236	311	46238237	313	46238239
39	53009681	53009681	1061	53009683	1063
40	53679671	53679671	521	53679673	523
41	53906597	53906597	227	53906599	229
42	54747418	269	54747419	271	54747421
43	57935326	659	57935327	661	57935329
44	63694847	63694847	1481	63694849	1483
45	68203229	68203229	1721	68203231	1723
46	73763380	2381	73763381	2383	73763383
47	84344411	84344411	269	84344413	271
48	86250580	1667	86250581	1669	86250583
49	92596529	92596529	1019	92596531	1021
50	94788077	94788077	1031	94788079	1033
51	95489237	95489237	101	95489239	103

In the case of 2-2 additive relations only 2 solutions contained composite numbers and these were the first two. This was explained in terms of the distribution Smarandache functions values. For the same reason 2-2 subtractive relations containing composite numbers are also scarce, but there are 6 of them for $n < 10^8$. These are shown in table 3.

It is interesting to note that solutions #3, #5 and #6 have in common with the solutions formed by pairs of prime twins that they are formed by pairs of numbers whose difference is 2. Finally table 4 shows a tabular comparison between the solutions to the 2-2 additive and 2-2 subtractive solutions for $n < 10^8$. The great similarity between these results leads the conclusion: If the conjecture that there are infinitely many 2-2 additive relations is valid then we also have the following conjecture:

Table 3. All 2-2 subtractive relations $<10^8$ containing composite numbers.

#	n	S(n)	S(n+1)	S(n+3)	S(n+4)
1	2	2	3	4	5
2	49	14	10	17	13
3	107	107	9	109	11
4	530452	202	166	419	383
5	41839378	111	41839379	113	41839381
6	48506848	57	48506849	59	48506851

Table 4. Comparison between 2-2 additive and 2-2 subtractive relations.

	Number of 2-2 additive solutions	Number of 2-2 subtractive sol.
Total number of solutions	481	442
Number formed by pairs of prime twins	65	51
Number containing composite numbers	2	6

Conjecture: There are infinitely many Smarandache 2-2 subtractive relationships.

References

1. H. Ibstedt, Smarandache k-k additive relationships, *Smarandache Notions Journal*, Vol. 12 (this issue).
2. M. Bencze, Smarandache Relationships and Subsequences, *Smarandache Notions Journal*, Vol. 11, No 1-2-3, pgs 79-85.

7, Rue du Sergent Blandan
92130 Issy les Moulineaux, France

On a Smarandache Partial Perfect Additive Sequence

Henry Ibstedt

Abstract: The sequence defined through $a_{2k+1}=a_{k+1}-1$, $a_{2k+2}=a_{k+1}+1$ for $k \geq 1$ with $a_1=a_2=1$ is studied in detail. It is proved that the sequence is neither convergent nor periodic - questions which have recently been posed. It is shown that the sequence has an amusing oscillating behavior and that there are terms that approach $\pm \infty$ for a certain type of large indices.

Definition of Smarandache perfect f_p sequence: If f_p is a p-ary relation on $\{a_1, a_2, a_3, \dots\}$ and $f_p(a_i, a_{i+1}, a_{i+2}, \dots, a_{i+p-1}) = f_p(a_j, a_{j+1}, a_{j+2}, \dots, a_{j+p-1})$ for all a_i, a_j and all $p > 1$, then $\{a_n\}$ is called a Smarandache perfect f_p sequence.

If the defining relation is not satisfied for all a_i, a_j or all p then $\{a_n\}$ may qualify as a Smarandache partial perfect f_p sequence.

The purpose of this note is to answer some questions posed in an article in the Smarandache Notions Journal, vol. 11 [1] on a particular Smarandache partial perfect sequence defined in the following way:

$$a_1 = a_2 = 1$$

$$a_{2k+1} = a_{k+1} - 1, \quad k \geq 1 \tag{1}$$

$$a_{2k+2} = a_{k+1} + 1, \quad k \geq 1 \tag{2}$$

Adding both sides of the defining equations results in $a_{2k+2} + a_{2k+1} = 2a_{k+1}$ which gives

$$\sum_{i=1}^{2n} a_i = 2 \sum_{i=1}^n a_i \tag{3}$$

Let n be of the form $n = k \cdot 2^m$. The summation formula now takes the form

$$\sum_{i=1}^{k \cdot 2^m} a_i = 2^m \sum_{i=1}^k a_i \tag{4}$$

From this we note the special cases $\sum_{i=1}^4 a_i = 4$, $\sum_{i=1}^8 a_i = 8$, \dots , $\sum_{i=1}^{2^m} a_i = 2^m$.

The author of the article under reference poses the questions: "Can you, readers, find a general expression of a_n (as a function of n)? Is the sequence periodical, or convergent or bounded?"

The first 25 terms of this sequence are¹:

k	1	2	3	4	5	6	7	8	9	10	11	12	13	14	15	16	17	18	19	20	21	22	23	24	25
a_k	1	1	0	2	-1	1	1	3	-2	0	0	2	0	2	2	4	-3	-1	-1	1	-1	1	1	3	-1

¹ The sequence as quoted in the article under reference is erroneous as from the thirteenth term.

It may not be possible to find a general expression for a_n in terms of n . For computational purposes, however, it is helpful to unify the two defining equations by introducing the δ -function defined as follows:

$$\delta(n) = \begin{cases} -1 & \text{if } n \equiv 0 \pmod{2} \\ 1 & \text{if } n \equiv 1 \pmod{2} \end{cases} \quad (5)$$

The definition of the sequence now takes the form:

$$a_1 = a_2 = 1$$

$$a_n = a_{\left(\frac{n+\delta(n)}{2}\right)} - \delta(n) \quad (6)$$

A translation of this algorithm to computer language was used to calculate the first 3000 terms of this sequence. A feeling for how this sequence behaves may be best conveyed by table 1 of the first 136 terms, where the switching between positive, negative and zero terms have been made explicit.

Before looking at some parts of this calculation let us make a few observations.

Although we do not have a general formula for a_n we may extract very interesting information in particular cases. Successive application of (2) to a case where the index is a power of 2 results in:

$$a_{2^m} = a_{2^{m-1}} + 1 = a_{2^{m-2}} + 2 = \dots = a_2 + m - 1 = m \quad (7)$$

This simple consideration immediately gives the answer to the main question:

The sequence is neither periodic nor convergent.

We will now consider the difference $a_n - a_{n-1}$ which is calculated using (1) and (2). It is necessary to distinguish between n even and n odd.

1. $n=2k, k \geq 2$.

$$a_{2k} - a_{2k-1} = 2 \text{ (exception: } a_2 - a_1 = 0) \quad (8)$$

2. $n=k \cdot 2^m + 1$ where k is odd.

$$a_{k \cdot 2^{m+1}} - a_{k \cdot 2^m} = a_{k \cdot 2^{m-1} + 1} - 1 - a_{k \cdot 2^{m-1}} - 1 = \dots = a_{k+1} - a_k - 2m = \begin{cases} 1 - 2m & \text{if } k=1 \\ 2 - 2m & \text{if } k > 1 \end{cases} \quad (9)$$

In particular

$$a_{2k+1} - a_{2k} = 0 \text{ if } k \geq 3 \text{ is odd.}$$

Table 1. The first 136 terms of the sequence

n	a_n	a_{n+1}	...	etc
1	1	1		
3	0			
4	2			
5	-1			
6	1	1	3	
9	-2			
10	0	0		
12	2			
13	0			
14	2	2	4	
17	-3	-1	-1	
20	1			
21	-1			
22	1	1	3	
25	-1			
26	1	1	3	1 3 3 5
33	-4	-2	-2	
36	0			
37	-2			
38	0	0		
40	2			
41	-2			
42	0	0		
44	2			
45	0			
46	2	2	4	
49	-2			
50	0	0		
52	2			
53	0			
54	2	2	4	
57	0			
58	2	2	4	2 4 4 6
65	-5	-3	-3	-1 -3 -1 -1
72	1			
73	-3	-1	-1	
76	1			
77	-1			
78	1	1	3	
81	-3	-1	-1	
84	1			
85	-1			
86	1	1	3	
89	-1			
90	1	1	3	1 3 3 5
97	-3	-1	-1	
100	1			
101	-1			
102	1	1	3	
105	-1			
106	1	1	3	1 3 3 5
113	-1			
114	1	1	3	1 3 3 5 1 3 3 5 3 5 5 7
129	-6	-4	-4	-2 -4 -2 -2
136	0			

The big drop. The sequence shows an interesting behaviour around the index 2^m . We have seen that $a_{2^m} = m$. The next term in the sequence calculated from (9) is $m+1-2 \cdot m = -m+1$. This makes for the spectacular behaviour shown in diagrams 1 and 2. The sequence gradually struggles to get to a peak for $n=2^m$ where it drops to a low and starts working its way up again. There is a great similarity between the oscillating behaviour shown in the two diagrams. In diagram 3 this behaviour is illustrated as it occurs between two successive peaks.

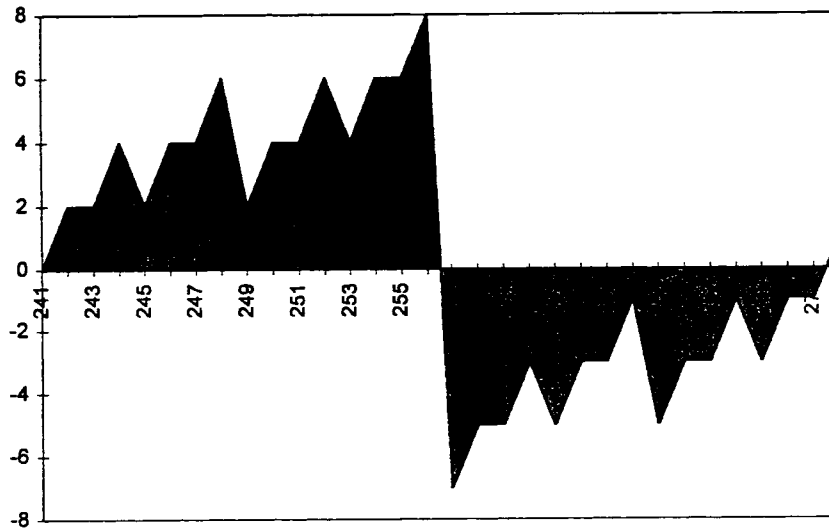

Diagram 1. a_n as a function of n around $n=2^8$ illustrating the "big drop"

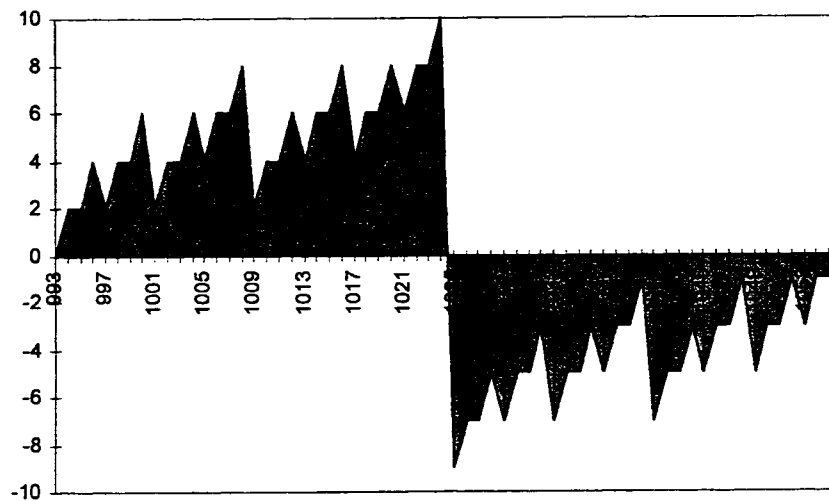

Diagram 2. a_n as a function of n around $n=2^{10}$ illustrating the "big drop"

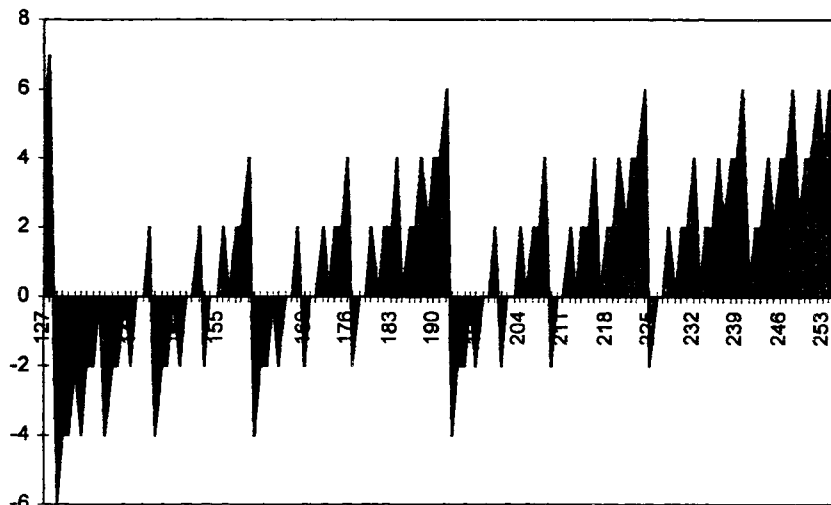

Diagram 3. The oscillating behaviour of the sequence between the peaks for $n=2^7$ and $n=2^8$.

When using the defining equations (1) and (2) to calculate elements of the sequence it is necessary to have in memory the values of the elements as far back as half the current index. We are now in a position to generate preceding and proceeding elements to a given element by using formulas based on (8) and (9).

The forward formulas:

$$a_n = \begin{cases} a_{n-1}+2 & \text{when } n=2k, k>1 \\ a_{n-1}+1-2m & \text{when } n=2^m+1 \\ a_{n-1}+2-2m & \text{when } n=k \cdot 2^m+1, k>1 \end{cases} \quad (10)$$

Since we know that $a_{2^m} = m$ it will also prove useful to calculate a_n from a_{n+1} .

The reverse formulas:

$$a_n = \begin{cases} a_{n+1}-2 & \text{when } n=2k-1, k>1 \\ a_{n+1}-1+2m & \text{when } n=2^m \\ a_{n+1}-2+2m & \text{when } n=k \cdot 2^m, k>1 \end{cases} \quad (11)$$

Finally let's use these formulas to calculate some terms forwards and backwards from one known value say $a_{4096}=12$ ($4096=2^{12}$). It is seen that a_n starts from 0 at $n=4001$, makes its big drop to -11 for $n=4096$ and remains negative until $n=4001$. For an even power of 2 the mounting sequence only has even values and the descending sequence only odd values. For odd powers of 2 it is the other way round.

Table 2. Values of a_n around $n=2^{12}$.

4095	4094	4093	4092	4091	4090	4089	4088	4087	4086	4085	4084	4083	4082	4081	4080	4079	4078 ...	4001
10	10	8	10	8	8	6	10	8	8	6	8	6	6	4	10	8	8 ...	0
4096	4097	4098	4099	4100	4101	4102	4103	4104	4105	4106	4107	4108	4109	4110	4111	4112	4113 ...	4160
12	-11	-9	-9	-7	-9	-7	-7	-5	-9	-7	-7	-5	-7	-5	-5	-3	-9 ...	1

References:

1. M. Bencze, Smarandache Relationships and Subsequences, *Smarandache Notions Journal*. Vol. 11, No 1-2-3, pgs 79-85.

ON THE 107-th, 108-th AND 109-th SMARANDACHE'S PROBLEMS

Nikolai Nikolov and Krassimir Atanassov

CLBME - Bulgarian Academy of Sciences,

Bl. 105, Acad. G. Bonchev Str., Sofia-1113, Bulgaria

e-mails: {shte, krat}@bgcict.acad.bg

Here we shall discuss three definitions regarded by Smarandache as paradoxical.

The analysis of the three definitions is of course a trivial task. Our only motivation for producing it was the desire of making clear the rather imprecise treatment of these paradoxes in [1].

Definition 1. n is called a paradoxist Smarandache number iff n does not belong to any of the Smarandache number sequences.

Let us denote the sequence of paradoxist Smarandache numbers by SP.

Definition 2. n is called non-Smarandache number iff n is neither a Smarandache paradoxist number nor a member of any of the Smarandache defined number sequences.

Let us denote the sequence of non-Smarandache numbers by NS.

We propose two accounts of Definition 1; in both, the apparent paradoxicality is eliminated.

Account 1. If the scope of the definition includes itself, i. e., if a number is called paradoxist iff it does not belong to any Smarandache sequence including SP, then SP is empty.

Proof: Assume SP is not empty and let $p \in SP$. Then, by the definition, p does not belong to any Smarandache sequence (including SP) and therefore $p \notin SP$, which is a contradiction with the assumption that $p \in SP$. Therefore, the contrary holds – that SP is empty.

In other words, SP is not paradoxical by nature, but just an empty sequence.

In this case, NS is equal to

$$N - \bigcup_j S_j$$

where $S_1 \dots S_n$ are all the rest of Smarandache sequences. This is proved by a simple check of Definition 2.

Account 2. If the scope of the definition excludes itself, i. e., if a number is called paradoxist iff it does not belong to any Smarandache sequence except SP, then SP is equal to

$$N - \bigcup_j S_j$$

where $S_1 \dots S_n$ are all the rest of Smarandache sequences.

Let us assume that SP is not empty and let $p \in SP$. As the definition of SP excludes the SP itself, p does not belong to any Smarandache sequence except SP, and therefore there is no contradiction with the assumption that $p \in SP$. From the definition it follows that p belongs to the set

$$N - \bigcup_j S_j$$

where $S_1 \dots S_n$ are all of the Smarandache sequences except SP. On the other hand, if SP is empty, then every natural number belongs to some Smarandache sequence other than SP. Since there are no members of SP, and the apparent paradox stemmed from the assumption that some number belongs to SP, no paradox arises in this case either.

Again, there is no paradoxicality here. We cannot, however, make statements about the members of SP in the latter case – it may be empty or not.

In this case, NS is empty. Proof: By definition 2, NS equals

$$N - \bigcup_j S_j - SP$$

and by the above, SP is

$$N - \bigcup_j S_j$$

where S_j are as above. Therefore NS is empty.

Finally, let us consider "the paradox of Smarandache numbers": Any number is a Smarandache number, the non-Smarandache number too.

On both accounts this is true. Therefore it is a mere play of words - it is a matter of choice of the name 'non-Smarandache number' that causes the apparent paradox.

REFERENCE:

[1] Dumitrescu C., V. Seleacu, Some Notions and Questions in Number Theory, Erhus Univ. Press, Glendale, 1994.

ON THE 20-th AND THE 21-st SMARANDACHE'S PROBLEMS

Krassimir T. Atanassov

CLBME - Bulg. Academy of Sci., and MRL, P.O.Box 12, Sofia-1113, Bulgaria

e-mail: krat@bgcict.acad.bg

The 20-nd problem from [1] is the following (see also Problem 25 from [2]):

Smarandache divisor products:

1, 2, 3, 8, 5, 36, 7, 64, 27, 100, 11, 1728, 13, 196, 225, 1024, 17, 5832, 19, 8000, 441, 484, 23,
331776, 125, 676, 729, 21952, 29, 810000, 31, 32768, 1089, 1156, 1225, 10077696, 37, 1444,
1521, 2560000, 41, ...

($P_d(n)$ is the product of all positive divisors of n .)

The 21-st problem from [1] is the following (see also Problem 26 from [2]):

Smarandache proper divisor products:

1, 1, 1, 2, 1, 6, 1, 8, 3, 10, 1, 144, 1, 14, 15, 64, 1, 324, 1, 400, 21, 22, 1, 13824, 5, 26, 27,
784, 1, 27000, 1, 1024, 33, 34, 35, 279936, 1, 38, 39, 64000, 1, ...

($p_d(n)$ is the product of all positive divisors of n but n .)

These problems their solutions are well-known and by this reason we shall give more unstandard solutions (see, e.g. [3]).

Let

$$n = \prod_{i=1}^k p_i^{a_i},$$

where $p_1 < p_2 < \dots < p_k$ are different prime numbers and $k, a_1, a_2, \dots, a_k \geq 1$ are natural numbers. Then

$$P_d(n) = \prod_{d/n} d.$$

Therefore, every divisor of n will be a natural number with the form

$$d = \prod_{i=1}^k p_i^{b_i},$$

where b_1, b_2, \dots, b_k are natural numbers and for every i ($1 \leq i \leq k$): $0 \leq b_i \leq a_i$, i.e.,

$$P_d(n) = \prod_{i=1}^k p_i^{c_i},$$

where c_1, c_2, \dots, c_k are natural numbers and below we shall discuss their form.

First, we shall note that for fixed where $k, a_1, a_2, \dots, a_k, p_1, p_2, \dots, p_k$ the number of the different divisors of n will be

$$\tau(n) = \prod_{i=1}^k (a_i + 1).$$

THEOREM: For every natural number $n = \prod_{i=1}^k p_i^{a_i}$:

$$P_d(n) = \prod_{i=1}^k p_1^{a_1+1} \cdot \dots \cdot p_{i-1}^{a_{i-1}+1} \cdot p_i^{t_{a_i}} \cdot p_{i+1}^{a_{i+1}+1} \cdot \dots \cdot p_k^{a_k+1}, \quad (1)$$

where $t_q = \frac{q \cdot (q+1)}{2}$ is the q -th triangular number.

Proof: When n is a prime number, i.e., $k = a_1 = 1$, the validity of (1) is obvious. Let us

assume that (1) is valid for some natural number $m = \sum_{i=1}^k a_i$. We shall prove (8) for $m+1$,

i.e., for the natural number $n' = n \cdot p$, where p is a prime number. There are two cases for p .

Case 1: $p \notin \{p_1, p_2, \dots, p_k\}$. Then

$$P_d(n') = P_d(n \cdot p) = (P_d(n)) \cdot (P_d(n) \cdot p^{(a_1+1)} \cdot \dots \cdot (a_k+1))$$

(because the first term contains all multipliers of n multiplied by 1 and in the second term - multiplied by p)

$$\begin{aligned} &= (P_d(n))^2 \cdot p^{(a_1+1)} \cdot \dots \cdot (a_k+1) = (P_d(n))^{a_{k+1}+1} \cdot p^{(a_1+1)} \cdot \dots \cdot (a_k+1) \cdot t_{a_{k+1}} \\ &= \prod_{i=1}^{k+1} p_1^{a_1+1} \cdot \dots \cdot p_{i-1}^{a_{i-1}+1} \cdot p_i^{t_{a_i}} \cdot p_{i+1}^{a_{i+1}+1} \cdot \dots \cdot p_{k+1}^{a_{k+1}+1}. \end{aligned}$$

Case 2: $p = p_s \in \{p_1, p_2, \dots, p_k\}$. Then $n = m \cdot p_s^{a_s}$ and

$$\begin{aligned} P_d(n') &= P_d(n \cdot p) = P_d(m \cdot p_s^{a_s+1}) = (P_d(m) \cdot 1) \cdot (P_d(m) \cdot p_s^{(a_1+1)} \cdot \dots \cdot (a_{s-1}+1) \cdot (a_{s+1}+1) \cdot \dots \cdot (a_k+1)) \\ &\quad \cdot (P_d(m) \cdot p_s^{2 \cdot (a_1+1)} \cdot \dots \cdot (a_{s-1}+1) \cdot (a_{s+1}+1) \cdot \dots \cdot (a_k+1)) \\ &\quad \cdot \dots \cdot (P_d(m) \cdot p_s^{(a_s+1) \cdot (a_1+1)} \cdot \dots \cdot (a_{s-1}+1) \cdot (a_{s+1}+1) \cdot \dots \cdot (a_k+1)) \\ &= (P_d(m))^{a_s+1} \cdot p_s^{(a_1+1)} \cdot \dots \cdot (a_{s-1}+1) \cdot (a_{s+1}+1) \cdot \dots \cdot (a_k+1) \cdot (1+2+\dots+(a_s+1)) \\ &= (P_d(m))^{a_s+1} \cdot p_s^{(a_1+1)} \cdot \dots \cdot (a_{s-1}+1) \cdot t_{a_s+1} \\ &= \prod_{i=1}^{k+1} p_1^{a_1+1} \cdot \dots \cdot p_{i-1}^{a_{i-1}+1} \cdot p_i^{t_{a_i}} \cdot p_{i+1}^{a_{i+1}+1} \cdot \dots \cdot p_{k+1}^{a_{k+1}+1}. \end{aligned}$$

Therefore, (1) is valid, i.e., Problem 20 is solved. Using it we can see easily, that

$$\begin{aligned}
 P_d(n) &= \prod_{i=1}^k p_1^{a_1+1} \cdot \dots \cdot p_{i-1}^{a_{i-1}+1} \cdot p_i^{\frac{a_i(a_i+1)}{2}} \cdot p_{i+1}^{a_{i+1}+1} \cdot \dots \cdot p_k^{a_k+1} \\
 &= \prod_{i=1}^k p_i^{\frac{1}{2} \cdot (a_i+1) \cdot \dots \cdot (a_i+1)} \cdot p_i^{a_i} \cdot \dots \cdot a_k \\
 &= \prod_{i=1}^k n^{\frac{1}{2} \cdot \tau(n)} \cdot n = n \cdot \sqrt{\prod_{i=1}^k n^{\tau(n)}},
 \end{aligned}$$

i.e.,

$$P_d(n) = n \cdot \sqrt{\prod_{i=1}^k n^{\tau(n)}}, \quad (2)$$

which is the standard form of the representation of $P_d(n)$.

From (2), having in mind that

$$p_d(n) = \frac{P_d(n)}{n}$$

it is seen directly that the solution of 21-st problem is

$$p_d(n) = \sqrt{\prod_{i=1}^k n^{\tau(n)}},$$

or in the form of (1):

$$p_d(n) = \prod_{i=1}^k p_1^{a_1+1} \cdot \dots \cdot p_{i-1}^{a_{i-1}+1} \cdot p_i^{\frac{a_i}{2}} \cdot p_{i+1}^{a_{i+1}+1} \cdot \dots \cdot p_k^{a_k+1}.$$

REFERENCE:

- [1] C. Dumitrescu, V. Seleacu, Some notions and questions in number theory, Erhus Univ. Press, Glendale, 1994.
- [2] F. Smarandache, Only problems, not solutions!, Xiquan Publ. House, Chicago, 1993.
- [3] T. Nagell, Introduction to Number Theory. John Wiley & Sons, Inc., New York, 1950.

ON PRIMALITY OF THE SMARANDACHE SYMMETRIC SEQUENCES

Sabin TABIRCA, Tatiana TABIRCA

"Transilvania" University of Brasov
Faculty of Science, Computer Science Department
Str. Iuliu Maniu, nr. 50, Brasov, 2200
Romania

The study of primality for the Smarandache sequences represents a recent research direction on the Smarandache type notions. A few articles that were published recently deal with the primality of the direct and reverse Smarandache sequences. The primality of Smarandache symmetric sequences has not been studied yet. This article proposes some results concerning the non-primality of these symmetric sequences and presents some interesting conclusions on a large computational test on these.

Key Words: Smarandache Symmetric Sequences, Prime Numbers, Testing Primality

Smarandache type notions represents one of the important and recent directions on which the research on Elementary Number Theory has been carried out on the last years. Many theoretical and practical studies concerning the Smarandache functions, numbers or sequences have been developed so far. The practical studies have proved that many conjectures and open problems on this kind of notions are true. This article follows this line by developing a large computation on the Smarandache symmetric sequence and after that by proving some non-primality results. But, the most important fact is the article proposes two special numbers of the sequences that are primes.

1. INTRODUCTION

In the following, the main notions that are used in this article are summarized and some recent results concerning them are reviewed. All of them concern the Smarandache sequences. There are three types of the Smarandache sequences presented below [4]:

- The direct Smarandache sequence: 1, 12, 123, 1234, ...
- The reverse Smarandache sequence: 1, 21, 321, 4321, ...
- The symmetric Smarandache sequence: 1,121, 1221, 12321, 123321, 1234321, 12344321,...

Let these sequences be denoted by:

$$Sd(n) = 123...n \quad (\forall n > 0) \quad (1.a.)$$

$$Sr(n) = n...321 \quad (\forall n > 0) \quad (1.b.)$$

In order to simplify the study of the symmetric Smarandache sequence, we note

$$S_1(n) = 123\dots(n-1)n(n-1)\dots321 \quad (\forall n > 0) \quad (2.a.)$$

$$S_2(n) = 123\dots(n-1)nn(n-1)\dots321 \quad (\forall n > 0) \quad (2.b.)$$

and called them the symmetric Smarandache sequences of the first and second order, respectively. These sequences have been intensely studied and some interesting results have been proposed so far.

The direct and reverse Smarandache were the subject to an intense computational study. Stephan [5] developed the first large computational study on these sequences. He analyzed the factorization of the first one hundred terms of these sequences finding no prime numbers within. In order to find prime numbers in these sequences, Fleuren [3] extended the study up to two hundred finding no prime numbers too. In [3], a list of people who study these computationally these sequences was presented. No prime numbers in these sequences have been found so far. Unfortunately, a computational study has not been done for the symmetric sequences yet.

The only result concerning the symmetric sequences was proposed by Le [2]. This result states that the terms $S_2(n) = 123\dots(n-1)nn(n-1)\dots321$ of the second Smarandache symmetric sequence are not prime if $\frac{n}{2} \not\equiv 1 \pmod{3}$. No computational results were furnished in this article for sustaining the theorem. Smarandache [4] proposed several proprieties on these three sequences, majority of them being open problems.

2. COMPUTATIONAL RESULTS

Testing primality has always represented a difficult problem. For deciding the primality of large numbers, special and complicated methods have been developed. The last generation ones use elliptic curve and are very efficient in finding prime factors large. For example, Fleuren used Elliptic Curve Primality Proving or Adleman-Pomerance-Rumely tests obtaining all prime factors up to 20 digits. More information about these special tests could be found in [1].

The computation that we have done uses MAPLE 5, which is software oriented to mathematical computations. This software contains several functions for dealing with primes and factorization such as *isprime*, *ifactor*, *ifactors*, *ithfactor*, etc. The function *ifactor* that is based on the elliptic curves can find prime factors depending on the method used. The easy version discovers prime factor up to 10 digits. The "Lenstra" method can find prime factors up to 20 digits. We used the simple version of *ifactor* for testing the terms of the Smarandache symmetric sequences. The computation was done for all the numbers between 2 and 100. The results are presented in Tables 1,2 of Appendix. Table 1 gives the factorization of the terms of the first Smarandache symmetric sequence. Table 2 provides the factorization of the second Smarandache symmetric sequence.

Several simple observations can be made by analyzing Tables 1, 2. The most important of them is that two prime numbers are found within. The term $S_1(10) = 12345678910987654321$ of the first Smarandache symmetric sequence is a prime number with 20 digits. Similarly, the term $S_2(10) = 1234567891010987654321$ of the second Smarandache symmetric sequence is a prime number with 22 digits. No other prime numbers

can be found in these two tables. The second remark is that the terms from the tables present similarities. For example, all the terms $S_1(3 \cdot k)$, $k > 1$ and $S_2(3 \cdot k - 1)$, $S_2(3 \cdot k)$, $k > 1$ are divisible by 3. This will follow us to some theoretical results. The third remark is that some prime factors satisfy a very strange periodicity. The factor (333667) appear 29 times in the factorization of the second Smarandache symmetric sequence. A supposition that can be made is the following *there are no prime numbers in the Smarandache symmetric sequences others that $S_1(10)$, $S_2(10)$.*

In the following, the prime numbers $S_1(10) = 12345678910987654321$ and $S_2(10) = 1234567891010987654321$ are named the Smarandache gold numbers. Perhaps, they are the largest and simplest prime numbers known so far.

3. PRIMALITY OF THE SMARANDACHE SYMMETRIC SEQUENCES

In this section, some theoretical results concerning the primality of the Smarandache symmetric sequences are presented. The remarks drawn from Tables 1,2 are proved to be true in general.

Let $ds(n)$, $n \in N^*$ be the digits sum of number n . It is known that a natural number n is divisible by 3 if and only if $3 \mid ds(n)$. A few simple results on this function are given in the following.

Proposition 1. $(\forall n > 1) ds(3n)$ is M3.

Proof

The proof is obvious by using the simple remarks $3n$ is M3. Thus, $ds(3n)$ is M3. ♣

Proposition 2. $(\forall n > 1) ds(3n-1) + ds(3n-2)$ is M3.

Proof

Let us suppose that the forms of the numbers $3n-1, 3n-2$ are

$$3 \cdot n - 2 = \overline{a_1 a_2 a_3 \dots a_p} \quad (3.)$$

$$3 \cdot n - 1 = \overline{b_1 b_2 b_3 \dots b_p}. \quad (4.)$$

Both of them have the same number of digits because $3n-2$ cannot be $999\dots 9$. The equation

$$ds(3 \cdot n - 2) + ds(3 \cdot n - 1) = a_1 + a_2 + \dots + a_p + b_1 + b_2 + \dots + b_p = ds(\overline{a_1 a_2 \dots a_p b_1 b_2 \dots b_p})$$

gives $ds(3 \cdot n - 2) + ds(3 \cdot n - 1) = ds((3 \cdot n - 2) \cdot 10^p + 3 \cdot n - 1)$.

The number $(3 \cdot n - 2) \cdot 10^p + 3 \cdot n - 1$ is divisible by 3 as follows

$$(3 \cdot n - 2) \cdot 10^p + 3 \cdot n - 1 = 10^p - 1 = (9 + 1)^p - 1 = 0 \pmod{3}.$$

Thus, $ds(3n-2) + ds(3n-1) = ds((3n-2)10^p + 3n-1)$ is M3. ♣

In order to prove that the number $S_1(3 \cdot k)$, $k > 1$ and $S_2(3 \cdot k - 1)$, $S_2(3 \cdot k)$, $k > 1$ are divisible by 3, Equations (5-6) are used.

$$ds(S_1(3 \cdot k)) = ds(S_1(3 \cdot k - 3)) + 2 \cdot ds(3 \cdot k - 2) + 2 \cdot ds(3 \cdot k - 1) + ds(3 \cdot k) \quad (5.)$$

$$ds(S_2(3 \cdot k)) = ds(S_2(3 \cdot k - 3)) + 2 \cdot ds(3 \cdot k - 2) + 2 \cdot ds(3 \cdot k - 1) + 2 \cdot ds(3 \cdot k) \quad (6.a.)$$

$$ds(S_2(3 \cdot k - 1)) = ds(S_2(3 \cdot k - 4)) + 2 \cdot ds(3 \cdot k - 3) + 2 \cdot ds(3 \cdot k - 2) + 2 \cdot ds(3 \cdot k - 1) \quad (6.b.)$$

Based on Propositions 1,2, Equations (5-6) give

$$ds(S_1(3 \cdot k)) = ds(S_1(3 \cdot k - 3)) \pmod{3} \quad (7.)$$

$$ds(S_2(3 \cdot k)) = ds(S_2(3 \cdot k - 3)) \pmod{3} \text{ and } ds(S_2(3 \cdot k - 1)) = ds(S_2(3 \cdot k - 4)) \pmod{3}. \quad (8.)$$

The starting point is given by $S_1(3) = 3^2 \cdot 37^2$ is M3, $S_2(2) = 3 \cdot 11 \cdot 37$ is M3, and $S_2(3) = 3 \cdot 11 \cdot 37 \cdot 101$ is M3. All the above facts provide an induction mechanism that proves obviously the following theorem.

Theorem 3. The numbers $S_1(3 \cdot k)$, $k \geq 1$ and $S_2(3 \cdot k - 1)$, $S_2(3 \cdot k)$, $k \geq 1$ are divisible by 3, thus are not prime.

Proof

This proof is given by the below implications.

$$S_1(3) = 3^2 \cdot 37^2 \text{ is M3, } ds(S_1(3 \cdot k)) = ds(S_1(3 \cdot k - 3)) \pmod{3} \Rightarrow S_1(3k) \text{ is M3, } k \geq 1.$$

$$S_2(2) = 3 \cdot 11 \cdot 37 \text{ is M3, } ds(S_1(3 \cdot k)) = ds(S_1(3 \cdot k - 3)) \pmod{3} \Rightarrow S_2(3k) \text{ is M3, } k \geq 1.$$

$$S_2(2) = 3 \cdot 11 \cdot 37 \cdot 101 \text{ is M3, } ds(S_2(3 \cdot k - 1)) = ds(S_2(3 \cdot k - 4)) \pmod{3} \Rightarrow S_2(3k-1) \text{ is M3, } k \geq 1.$$

4. FINAL REMARKS

This article has provided both a theoretical and computational study on the Smarandache symmetric sequences. This present study can be further developed on two ways. Firstly, the factorization can be refined by using a more powerful primality testing technique. Certainly, the function *ifactor* used by Lenstra's method may give factors up to 20 digits. Secondly, the computation can be extended up to 150 in order to check divisibility property. Perhaps, the most interested fact to be followed is if the factor (333667) appears periodically in the factorization of the second Smarandache sequence.

The important remark that can be outlined is two important prime numbers were found. These are 12345678910987654321 and 1234567891010987654321. We have named them the Smarandache gold numbers and represent large numbers that can be memorized easier. Moreover, they seem to be the only prime numbers within the Smarandache symmetric sequences.

REFERENCES

[1] BACH E., SHALLIT J., Algorithmic number theory, MIT Press, Massachusetts, 1998.
 [2] LE M., *The primes in the Smarandache symmetric sequence*, Smarandache Notion Journal, Vol.10, No.1-3, (1999), 174-175.
 [3] Fleuren M., *The prime factors on the Smarandache symmetric sequence*, Smarandache Notion Journal, Vol.10, No.1-3, (1999), 5-38.
 [4] SMARANDACHE F., Only problems, Not solutions!, Xiquan Publ., Pheonix-Chicago, 1993.
 [5] STEPHAN R. W., *Factors and primes in two Smarandache sequences*, Smarandache Notion Journal, Vol. 8, No.9 (1998), 4-10.

APPENDIX - The results of the computation.

<i>n</i>	<i>Digits</i>	<i>Factorisation</i>
2	3	$(11)^2$
3	5	$(3)^2(37)^2$
4	7	$(11)^2(101)^2$
5	9	$(41)^2(271)^2$
6	11	$(3)^2(7)^2(11)^2(13)^2(37)^2$
7	13	$(239)^2(4649)^2$
8	15	$(11)^2(73)^2(101)^2(137)^2$
9	17	$(3)^4(37)^2(333667)^2$
10	20	PRIME
11	24	$(7)(17636684157301569664903)$
12	28	$(3)^2(7)^2(2799473675762179389994681)$
13	32	$(1109)(4729)(2354041513534224607850261)$
14	36	$(7)(571)(3167)(10723)(439781)(2068140300159522133)$
15	40	$(3)^2(7)(3167)(10723)(75401)(439781)(687437)_{c27}$
16	44	$(71)(18428)_{c37}$
17	48	$(7)^2(31)_{c44}$
18	52	$(3)^5(7)(8087)(89744777939149063905891825989378400337330283)$
19	56	$(251)(281)(5519)(96601)_{c42}$
20	60	$(7)(17636684157301733059308816884574168816593059017301569664903)$
21	64	$(3)^2(7)_{c62}$
22	68	$(70607)_{c63}$
23	72	$(7)(15913)_{c67}$
24	76	$(3)^2(7)(659)(56383)_{c66}$
25	80	NO Answer, Yet
26	84	$(7)(3209)(17627)_{c75}$
27	88	$(3)^4(7)(223)(28807)_{78}$
28	92	$(149)(82856905436988007661182361202698806929028608924581377465249745095179303029618262489850029)$
29	96	$(7)_{c95}$
30	100	$(3)^2(7)(167)(761)_{93}$
31	104	$(827)_{c101}$
32	108	$(7)(31)(42583813)_{c98}$
33	112	$(3)^2(7)^2(281)_{c106}$
34	116	$(197)(509)_{c111}$
35	120	$(7)(10243)_{c115}$
36	124	$(3)^6(7)(2399)_{c117}$
37	128	NO Answer, Yet
38	132	$(7)^2(313)_{c127}$
39	136	$(3)^2(7)(733)(2777)_{c127}$
40	140	$(17047)(28219)_{131}$
41	144	$(7)(5153)(7687)(79549)_{c130}$
42	148	$(3)^2(7)(9473)_{c142}$
43	152	$(191)(4567)_{c?}$
44	156	$(7)(223)(251)_{c150}$
45	160	$(3)^6(7)(643303)_{c150}$
46	164	$(967)(33289)_{c156}$
47	168	$(7)(31)(199)(281)_{c161}$
48	172	$(3)^2(7)(557)(38995472881)_{c156}$
49	176	$(139121)_{c170}$
50	180	$(7)(179)$
51	184	$(3)^2(7)(71)(55697)_{c175}$
52	188	$(109)(181)_{c183}$

53	192	$(7)(14771)$ c187
54	196	$(3)^4(7)^3(191)(3877)$ c185
55	200	(5333) c196
56	204	$(7)(73589)$ c198
57	208	$(3)^2(7)(3389)(56591)$ c198
58	212	NO Answer, Yet
59	216	$(7)^2$ c214
60	220	$(3)^2(7)(14769967)$ c211
61	224	$(281)(286813)$ c216
62	228	$(7)(31)$ c?
63	232	$(3)^2(7)$ c228
64	236	NO Answer, Yet
65	240	(7) c239
66	244	$(3)^2(7)$ c242
67	248	NO Answer, Yet
68	252	$(7)(1861)(12577)(19163)$ c?
69	256	$(3)^2(7)(251)(1861)$ c248
70	260	NO Answer, Yet
71	264	(7) c263
72	268	$(3)^5(7)(563)(3323)$ c258
73	272	$(2477)(3323)(3943)$ c265
74	276	$(7)(47279)$ c270
75	280	$(3)^2(7)^2(281)(7681)$ c271
76	284	NO Answer, Yet
77	288	$(7)(31)$ c285
78	292	$(3)^2(7)$ c290
79	296	$(313)(6529)(63311)$ c284
80	300	$(7)^3(130241)$ c292
81	304	$(3)^4(7)$ c301
82	308	NO Answer, Yet
83	312	$(7)(197)$ c308
84	316	$(3)^2(7)(1931)(110323)$ c305
85	320	$(953)(1427)(103573)$ c308
86	324	$(7)(71)(181)$ c319
87	328	$(3)^2(7)(491)$ c?
88	332	NO Answer, Yet
89	336	$(7)(281)(50581)$ c328
90	340	$(3)^5(7)(67121)$ c332
91	344	(19501) c339
92	348	$(7)(31)(571)(811)$ c340
93	352	$(3)^2(7)$ c350
94	356	$(251)(79427)$ c348
95	360	(7) c359
96	364	$(3)^2(7)^2$ c361
97	368	(7559) c364
98	372	$(7)(1129)(4703)(63367)$
99	376	$(3)^5(7)$ c372
100	381	NO Answer, Yet

Table 1. Smarandache Symmetric Sequence of the first order.

<i>n</i>	<i>Digits</i>	<i>Factorisation</i>
2	4	(3)(11)(37)
3	6	(3)(11)(37)(101)
4	8	(11)(41)(101)(271)
5	10	(3)(7)(11)(13)(37)(41)(271)
6	12	(3)(7)(11)(13)(37)(239)(4649)
7	14	(11)(73)(137)(239)(4649)
8	16	(3) ² (11)(37)(73)(101)(137)(333667)
9	18	(3) ² (11)(37)(41)(271)(333667)(9091)
10	22	PRIME
11	26	(3)(43)(97)(548687)(1798162193492119)
12	30	(3)(11)(31)(37)(61)(92869187)(575752909227253)
13	34	(109)(3391)(3631)(919886914249704430301189)
14	38	(3)(41)(271)(9091)(290971)(140016497889621568497917)
15	42	(3)(37)(661)(1682637405802185215073413380233484451)
16	46	No Answer Yet
17	50	(3) ² (1371742101123468126835130190683490346790109739369)
18	54	(3) ² (37)(1301)(333667)(6038161) c36
19	58	(41)(271)(9091) c50
20	62	(3)(11)(97) c58
21	66	(3)(37)(983) c61
22	70	(67)(773)(2383749861966990503207452683288838257844397322240377925143576831)
23	74	(3)(11)(7691) c68
24	78	(3)(37)(41)(43)(271)(9091)(165857) c61
25	82	(227)(2287)(33871) c71
26	86	(3) ² (163)(5711) c78
27	90	(3) ² (31)(37)(333667) c80
28	94	(146273)(608521) c83
29	98	(3)(41)(271)(9091)(40740740407441077407747474744141750841417542087508417508414141414141077441077407407407407)
30	102	(3)(37)(5167) c96
31	106	(11) ³ (4673) c99
32	110	(3)(43)(1021) c?
33	114	(3)(37)(881) c109
34	118	(11)(41)(271)(9091) c109
35	122	(3) ² (3209) c117
36	126	(3) ² (37)(333667)(68697367) c110
37	130	No Answer Yet
38	134	(3)(1913)(12007)(58417)(597269) c115
39	138	(3)(37)(41)(271)(347)(9091)(23473) c121
40	142	No Answer Yet
41	146	(3)(156841) c140
42	150	(3)(11)(31)(37)(61) c143
43	154	(71)(5087) c?
44	158	(3) ² (41)(271)(9091) c149
45	162	(3) ² (11)(37)(43)(333667) c151
46	166	No Answer Yet
47	170	(3) c169
48	174	(3)(37)(173)(60373) c165
49	178	(41)(271)(929)(34613)(9091) c162
50	182	(3)(167)(1789)(9923)(159652607) c163
51	186	(3)(37)(1847) C180
52	190	No Answer Yet
53	194	(3) ³ (11)(43)(26539) c185

54	198	$(3)^3(37)(41)(151)(271)(347)(463)(9091)(333667)$ c174
55	202	(67) c200
56	206	(3) c205
57	210	$(3)(37)$ c208
58	214	$(59)(109)$ c210
59	218	$(3)(11)^2(41)(59)(271)(9091)$ c205
60	222	$(3)(37)(8837)$ c216
61	226	$(11)^2(17)(197)(631)$ c217
62	230	$(3)^4(19)(72617)$ c222
63	234	$(3)^2(37)(333667)$ c226
64	238	$(41)(89)(271)(9091)(63857)(6813559)$ c216
65	242	$(3)(2665891)$ c235
66	246	$(3)(37)$ c244
67	250	(1307) c246
68	254	$(3)(43)(107)(8147)(3373)(37313)$ c237
69	258	$(3)(17)(37)(41)(271)(1637)(9091)(4802689)$ c236
70	262	$(11)(109)(21647107)$
71	266	$(3)^2(19)$ c263
72	270	$(3)^2(11)(37)(333667)(1099081)$ c254
73	274	No Answer Yet
74	278	$(3)(41)(271)(1481)(9091)$ c266
75	282	$(3)(37)(17827)(26713)$ c271
76	286	No Answer Yet
77	290	$(3)(17)^2(337)(8087)(341659)$ c275
78	294	$(3)(37)$ c292
79	298	$(41)(271)(9091)(10651)(98887)$ c281
80	302	$(3)^2(19)$ c299
81	306	$(3)^6(11)(37)(333667)$ c295
82	310	No Answer Yet
83	314	$(3)(11)(41543)(48473)(69991)$ c298
84	318	$(3)(37)(41)(271)(9091)$ c308
85	322	$(17)(2203)(19433)$ c313
86	326	$(3)(89)(193)$ c321
87	330	$(3)(37)(59)$ c326
88	334	$(59)(67)$ c330
89	338	$(3)^3(19)(41)(43)(271)(9091)$ c325
90	342	$(3)^2(37)(333667)$ c334
91	346	No Answer Yet
92	350	$(3)(11)(18859)$ c344
93	354	$(3)(17)(37)(1109)(1307)$ c344
94	358	$(11)(41)(271)(9091)$ c349
95	362	(3) c361
96	366	$(3)(37)(373)(169649)(24201949)$ c348
97	370	$(113)(163)(457)(7411)$ c359
98	374	$(3)^2(19)(572597)$ c366
99	378	$(3)^2(37)(41)(271)(499)(593)(333667)(9091)$ c?
100	384	(89) c382

Table 2. Smarandache Symmetric Sequence of the second order.

ON FOUR PRIME AND COPRIME FUNCTIONS

Krassimir T. Atanassov

CLBME - Bulg. Academy of Sci., and MRL, P.O.Box 12, Sofia-1113, Bulgaria

e-mail: krat@bgcict.acad.bg

Devoted to Prof. Vladimir Shkodrov
for his 70-th birthday

In [1] F. Smarandache discussed the following particular cases of the well-know characteristic functions (see, e.g., [2] or [3]).

1) Prime function: $P : N \rightarrow \{0, 1\}$, with

$$P(n) = \begin{cases} 0, & \text{if } n \text{ is prime} \\ 1, & \text{otherwise} \end{cases}$$

More generally: $P_k : N^k \rightarrow \{0, 1\}$, where $k \geq 2$ is an integer, and

$$P_k(n_1, n_2, \dots, n_k) = \begin{cases} 0, & \text{if } n_1, n_2, \dots, n_k \text{ are all prime numbers} \\ 1, & \text{otherwise} \end{cases}$$

2) Coprime function is defined similarly: $C_k : N^k \rightarrow \{0, 1\}$, where $k \geq 2$ is an integer, and

$$C_k(n_1, n_2, \dots, n_k) = \begin{cases} 0, & \text{if } n_1, n_2, \dots, n_k \text{ are coprime numbers} \\ 1, & \text{otherwise} \end{cases}$$

Here we shall formulate and prove four assertions related to these functions.

THEOREM 1: For each k, n_1, n_2, \dots, n_k natural numbers:

$$P_k(n_1, \dots, n_k) = 1 - \prod_{i=1}^k (1 - P(n_i)).$$

Proof: Let the given natural numbers n_1, n_2, \dots, n_k be prime. Then, by definition

$$P_k(n_1, \dots, n_k) = 0.$$

In this case, for each i ($1 \leq i \leq k$):

$$P(n_i) = 0,$$

i.e.,

$$1 - P(n_i) = 1.$$

Therefore

$$\prod_{i=1}^k (1 - P(n_i)) = 1,$$

i.e.,

$$1 - \prod_{i=1}^k (1 - P(n_i)) = 0 = P_k(n_1, \dots, n_k). \quad (1)$$

If at least one of the natural numbers n_1, n_2, \dots, n_k is not prime, then, by definition

$$P_k(n_1, \dots, n_k) = 1.$$

In this case, there exists at least one i ($1 \leq i \leq k$) for which:

$$P(n_i) = 1,$$

i.e.,

$$1 - P(n_i) = 0.$$

Therefore

$$\prod_{i=1}^k (1 - P(n_i)) = 0,$$

i.e.,

$$1 - \prod_{i=1}^k (1 - P(n_i)) = 1 = P_k(n_1, \dots, n_k). \quad (2)$$

The validity of the theorem follows from (1) and (2).

Similarly it can be proved

THEOREM 2: For each k, n_1, n_2, \dots, n_k natural numbers:

$$C_k(n_1, \dots, n_k) = 1 - \prod_{i=1}^{k-1} \prod_{j=i+1}^k (1 - C_2(n_i, n_j)).$$

Let p_1, p_2, p_3, \dots be the sequence of the prime numbers ($p_1 = 2, p_2 = 3, p_3 = 5, \dots$).

Let $\pi(n)$ be the number of the primes less or equal to n .

THEOREM 3: For each natural number n :

$$C_{\pi(n)+P(n)}(p_1, p_2, \dots, p_{\pi(n)+P(n)-1}, n) = P(n).$$

Proof: Let n be a prime number. Then

$$P(n) = 0$$

and

$$p_{\pi(n)} = n.$$

Therefore

$$C_{\pi(n)+P(n)}(p_1, p_2, \dots, p_{\pi(n)+P(n)-1}, n) = C_{\pi(n)}(p_1, p_2, \dots, p_{\pi(n)-1}, p_{\pi(n)}) = 0,$$

because the primes $p_1, p_2, \dots, p_{\pi(n)-1}, p_{\pi(n)}$ are also coprimes.

Let n be not a prime number. Then

$$P(n) = 1$$

and

$$p_{\pi(n)} < n.$$

Therefore

$$C_{\pi(n)+P(n)}(p_1, p_2, \dots, p_{\pi(n)+P(n)-1}, n) = C_{\pi(n)+1}(p_1, p_2, \dots, p_{\pi(n)-1}, n) = 1,$$

because, if n is a composite number, then it is divided by at least one of the prime numbers

$p_1, p_2, \dots, p_{\pi(n)-1}$.

With this the theorem is proved.

Analogically, it is proved the following

THEOREM 4: For each natural number n :

$$P(n) = 1 - \prod_{i=1}^{\pi(n)+P(n)-1} (1 - C_2(p_i, n)).$$

COROLLARY: For each natural numbers k, n_1, n_2, \dots, n_k :

$$P_k(n_1, \dots, n_k) = 1 - \prod_{i=1}^k \prod_{j=1}^{\pi(n_i)+P(n_i)-1} (1 - C_2(p_j, n_i)).$$

These theorems show the connections between the prime and coprime functions. Clearly, it is the C_2 function basing on which all the rest of functions above can be represented.

REFERENCES:

- [1] Smarandache, F., Collected Papers, Vol. II, Kishinev University Press, Kishinev, 1997.
- [2] Grauert H., Lieb I., Fischer W, Differential- und Integralrechnung, Springer-Verlag, Berlin, 1967.
- [3] Yosida K., Functional Analysis, Springer-Verlag, Berlin, 1965.

INVESTIGATING CONNECTIONS BETWEEN SOME SMARANDACHE SEQUENCES, PRIME NUMBERS AND MAGIC SQUARES

Y.V. CHEBRAKOV, V.V. SHMAGIN
*Department of Mathematics, Technical University,
Nevsky 3-11, 191186, St-Petersburg, Russia
E-mail: chebra@phdeg.hop.stu.neva.ru*

In this paper we investigate some properties of Smarandache sequences of the 2nd kind and demonstrate that these numbers are near prime numbers. In particular, we establish that prime numbers and Smarandache numbers of the 2nd kind (a) may be computed from the similar analytical expressions, (b) may be used for constructing Magic squares 3×3 or Magic squares 9×9 , consisted of 9 Magic squares 3×3 .

Key words: prime numbers, Smarandache numbers of the 2nd kind, density of numerical sequences, Magic squares 3×3 and 9×9 .

1 Introduction

We remind [2, 3], that in the general case *Magic squares* represent by themselves numerical or analytical square tables, whose elements satisfy a set of definite basic and additional relations. The basic relations therewith assign some constant property for the elements located in the rows, columns and two main diagonals of a square table, and additional relations, assign additional characteristics for some other sets of its elements.

Let it be required to construct Magic squares $n \times n$ in size from a given set of numbers. Judging by the mentioned general definition of Magic squares, there is no difficulty in understanding that the foregoing problem consists of the four interrelated problems

1. Elaborate the practical methods for generating the given set of numbers;
2. Look for a concrete family of n^2 elements, which would satisfy both the basic and all the additional characteristics of the Magic squares;
3. Determine how many Magic squares can be constructed from the chosen family of n^2 elements;
4. Elaborate the practical methods for constructing these Magic squares.

For instance, as we demonstrated in [5],

a) every $(n+1)$ -th term a_{n+1} of Smarandache sequences of 1st kind may be formed by subjoining several natural numbers to previous terms a_n and also may be computed from the analytical expression

$$a_{\varphi(n)} = \sigma(a_n 10^{\psi(a_n)} + \xi\{\varphi(n)\}), \quad (1)$$

where $\varphi(n)$, $\psi(a_n)$ and $\xi\{\varphi(n)\}$ are some functions; σ is an operator. In other words, for generating Smarandache sequences of 1st kind, the set of analytical formulae may be used (see the problem 1);

22232425262728	15161718192021	20212223242526
17181920212223	19202122232425	21222324252627
18192021222324	23242526272829	16171819202122

(1)

171819191817	101112121110	151617171615
121314141312	141516161514	161718181716
131415151413	181920201918	111213131211

(2)

17181920191817	10111213121110	15161718171615
12131415141312	14151617161514	16171819181716
13141516151413	18192021201918	11121314131211

(3)

Figure 1. Magic squares 3×3 from k -truncated Smarandache numbers of 1st kind.

b) it is impossible to construct Magic squares 3×3 from Smarandache numbers of 1st kind without previous truncating these numbers. Consequently, if the given set of numbers consists only of Smarandache numbers of 1st kind, then one releases from care on solving problems, mentioned above in items 2 – 4;

c) there is a set of analytical formulae available for constructing Magic squares 3×3 in size from k -truncated Smarandache numbers of 1st kind (examples of Magic squares 3×3, obtained by these formulae, are shown in figure 1). In this case the foregoing set of analytical formulae is also the desired practical method for constructing Magic squares 3×3 from k -truncated Smarandache numbers of 1st kind (see the problem 4).

The *main goal* of this paper is to investigate some properties of Smarandache sequences of the 2nd kind [6, 9] and to demonstrate that these numbers are near prime numbers. In particular, we establish in the paper, that prime numbers and Smarandache numbers of the 2nd kind

a) may be computed from the similar analytical expressions (see Section 2 and 3);

b) may be used for constructing Magic squares 3×3 or Magic squares 9×9 , consisted of 9 Magic squares 3×3 (see Section 5 and 6).

2 Prime Numbers

We remind that in number theory [2, 10, 11] any positive integer (any natural number), simultaneously dividing positive integers a, b, \dots, m , is called their *common divisor*. The largest of common divisors is called *greatest common divisor* and denoted by the symbol $\text{GCD}(a, b, \dots, m)$. The existence of GCD appears from the finiteness of the number of common divisors. The numbers a and b for which $\text{GCD}(a, b) = 1$ are called *relatively prime numbers*. The analytical formula available for counting the value of $\text{GCD}(a, b)$ has form [6]

$$\text{GCD}(a, b) = b\{1 - \text{sign}(r)\} + k \text{sign}(r), \quad r = a - b[a/b], \quad (2)$$

$$k = \underset{i=2}{\overset{[b/2]}{\text{MAX}}} \{i(1-d)\}, \quad d = \text{sign}\{a - i[a/i]\} + \text{sign}\{b - i[b/i]\},$$

where the function $\text{MAX}(a_1, a_2, \dots, a_i)$ gives the greatest from numbers a_1, a_2, \dots, a_i ; $\text{sign}(x) = |x|/x$ if $x \neq 0$ and $\text{sign}(0) = 0$.

It is easy to prove, that any natural number larger than a unit, has no less than two divisors: the unit and itself. Any natural number $p > 1$, having exactly two divisors, is called *prime*. If the number of divisors is more than 2, then the number is called *composite* (for example, the number 11, having divisors 1 and 11, is the prime number, whereas the number 10, having the divisors 1, 2, 5 and 10, is the composite number). In this paper we shall consider the number 1 as the least prime number. The analytical formula, generating n -th prime number p_n , has form [6]

$$p_n = \sum_{m=0}^{(n+1)^2-1} \text{sg}(n-1 - \sum_{i=3}^m \chi_i), \quad \chi_i = \prod_{j=2}^{[i]} \{\text{sg}(i - j[i/j])\}, \quad (3)$$

where $p_2 = 2, p_3 = 3, p_4 = 5, \dots$; $\text{sg}(x) = 1$ if $x > 0$ and $\text{sg}(x) = 0$ if $x \leq 0$.

It is proved in the number theory [2, 10, 11], that any natural number larger than a unit can be represented as a product of prime numbers and this representation is unique (we assume that products, differing only by the order of cofactors, are identical). For solving the problem on decomposing the natural number a in simple cofactors, it is necessary to know all the prime numbers $p_a < \sqrt{a}$.

Let $m = [\sqrt{a}]$, where the notation $[b]$ means integer part from b . Then, for finding all the prime number p_a one may use the following procedure (*Eratosthenes sieve*) [2, 10, 11]:

1. Write out all the successive numbers from 2 to m and put $p = 2$;

2. In the series of the numbers $2, 3, 4, \dots, m$, cross out all the numbers having the form $p + kp$, where $k = 1, 2, \dots$;
3. If, in the series of the numbers $2, 3, 4, \dots, m$, all the numbers larger than p have been crossed out, then pass to step 4. If there still remain the numbers larger than p , which have not been crossed out, then the first of these ones we denote by p_1 . If $p_1^2 \geq m$, then pass to step 4. Otherwise, put $p = p_1$ and pass to step 2;
4. The end of the procedure: primes are all the numbers of the series $1, 2, 3, 4, \dots, m$, which have not been deleted.

If an arithmetical progression from n prime numbers is found then it should be known that [2, 10]

The difference of any arithmetical progression, containing n prime numbers larger than n , is divisible by all the prime numbers $\leq n$ (Cantor theorem).

From the series of the consecutive prime numbers one may reveal subsequences of numbers, possessed the different interesting properties. For instance

a) two prime numbers are called *reversed*, if each is obtained from other by reversing of its digits. If $p < 1\ 000$ then such numbers are

1, 2, 3, 5, 7, 11, 13, 17, 31, 37, 71, 73, 79, 97, 101, 107, 113, 131, 149, (4)
 151, 157, 167, 179, 181, 191, 199, 311, 313, 337, 347, 353, 359, 373,
 383, 389, 701, 709, 727, 733, 739, 743, 751, 757, 761, 769, 787, 797,
 907, 919, 929, 937, 941, 953, 967, 971, 983, 991.

b) among the numbers of (4) one may reveal the *symmetric* prime numbers:

1, 2, 3, 5, 7, 11, 101, 131, 151, 181, 191, 313, 353, 373, 383, 727, 757, (5)
 787, 797, 919, 929;

c) two prime numbers are called *mirror-reversed*, if each is obtained from other by reflecting in the mirror, located above the number. If $p < 3\ 000$ then such numbers are:

1, 2, 3, 5, 11, 13, 23, 31, 53, 83, 101, 131, 181, 227, 251, 311, 313, (6)
 331, 383, 521, 557, 811, 823, 853, 881, 883, 1013, 1021, 1031, 1033,
 1051, 1103, 1123, 1153, 1181, 1223, 1231, 1283, 1301, 1303, 1381,
 1531, 1553, 1583, 1811, 1831, 2003, 2011, 2053, 2081, 2113, 2203,
 2251, 2281, 2333, 2381, 2531, 2851.

3 Smarandache Numbers of the 2nd Kind

In this section we consider 4 different Smarandache sequences of the 2nd kind [6, 9] and demonstrate that the value of n -th numbers a_n in these sequences may be computed by the universal analytical formula {compare with formula (3)}

$$a_n = \sum_{m=0}^{U_n} \text{sg}(n+2-b-\sum_{i=1}^m \chi_i), \quad (7)$$

where χ_i are the characteristic numbers for the described below Smarandache sequences of the 2nd type and $U_n = 10 + (n+1)^2$.

3.1 Pseudo-Prime Numbers

a) Smarandache P_1 -series

$$1, 2, 3, 5, 7, 11, 13, 14, 16, 17, 19, 20, 23, 29, 30, 31, 32, 34, \dots \quad (8)$$

contains the only such natural numbers, which are or prime numbers itself or prime numbers can be obtained from P_1 -series numbers by a permutation of digits (for instance, the number 115 is the pseudo-prime of P_1 -series because the number 151 is the prime).

It is clear from the description of P_1 -series numbers that they may be generated by the following algorithm

1. Write out all the successive prime numbers from 1 to 13: 1, 2, 3, 5, 7, 11, 13 and put $n=8$; $a_n = 13$;
2. Assume $p = a_n + 1$.
3. Examine the number p . If p is a prime or a prime number can be obtained from a_n by a permutation of digits, then increase n by 1, put $a_n = p$ and go to step 2. Else increase p by 1 and go to the beginning of this step.

To convert the foregoing algorithm into a computer-oriented method (see problem 1 in Section 1), we are evidently to translate this description into one of special computer-oriented languages. There is a set of methods to realise such translation [6]. The most simplest among ones is to write program code directly from the verbal description of the algorithm without any preliminary construction. For instance, Pascal program identical with the verbal description of the algorithm under consideration are shown in Table 1. In this program the procedure *Pd*, the functions *PrimeList* and *PseudoPrime* are used for generating respectively permutations, primes numbers and pseudo-prime numbers; the meaning of the logical function *BelongToPrimes* is clear from its name.

In the case, when verbal descriptions are complex, babelized or incomplete, the translation of these descriptions into computer languages may be performed sometimes in two stages [7]: firstly, verbal descriptions of computational algorithms are translated into analytical ones and then analytical descriptions are translated into computer languages. To demonstrate how this scheme is realised in practice, let us apply it to the algorithm, generating P_1 -series numbers.

Table 1. Pascal program 1 for generating Smarandache P_1 -series

```

Type Ten=Array[1..10]Of Integer;
Procedure Pd(Var m4,n1,n:Integer;Var
nb3,nb4,nb5:Ten);
Label A28,A29,A30; Var nt,k,m:Integer;
Begin
  If M4=1 Then
    Begin
      m4:=0;n:=n1;
      For k:=2 to n do
        Begin Nb4[k]:=0; Nb5[k]:=1; End;
      Exit;
    End;
  k:=0; n:=n1;
A28: m:=Nb4[n]+Nb5[n];Nb4[n]:=m;
  If m=n Then
    Begin Nb5[n]:=-1;Goto A29; End;
  If Abs(m)>0 Then Goto A30;
  Nb5[n]:=1;Inc(k);
A29: If n>2 Then
  Begin Dec(n);Goto A28; End;
  Inc(m);m4:=1;
A30: m:=m+k; nt:=nb3[m];
  nb3[m]:=nb3[m+1]; nb3[m+1]:=nt
End;

Const Mn=10000; MaxN:Integer=Mn;
Type int=Array[1..Mn]Of Integer; pint=int;
Var pl:pint;

Function PrimeList(Var MaxN:Integer):pint;
Var i,j,k:Integer; p:pint;Ok:Boolean;
Begin
  GetMem(p,MaxN); p^[1]:=2;i:=3;k:=1;
  While i<MaxN do
    Begin {Is i prime or not ?}
      j:=3;Ok:=True;
      While Ok And (j<=Round(Sqrt(i))) do
        If i mod j=0 Then Ok:=False
        Else Inc(j,2);
        If Ok Then Begin Inc(k);p^[k]:=i;End;
        Inc(i,2);
      End;
      MaxN:=k;Primelist:=p;
    End {PrimeList} ;

Function
BelongToPrimes(num:Integer):Boolean;
Var l,r,j:Integer;
Begin
  BelongToPrimes:=True; l:=1;r:=MaxN;
  Repeat
    j:=(l+r)shr 1; If num<P1^[j] Then r:=j
    Else If num>P1^[j] Then l:=j+1
    Else Exit;
    Until l=r;BelongToPrimes:=False;
  End;

Function
PseudoPrime(Num:Integer):Boolean;
Var g,nb3,nb4,nb5:Ten;
  nd,m,r,mn,m4,n1,mm,i,j,d,k,n:Integer;
Begin
  PseudoPrime:=True;
  {Decomposition number num on digits}
  d:=Num;k:=0;
  Repeat
    Inc(k); g[k]:=d mod 10;
    r:=d; d:=d div 10;
  Until r div 10=0;
  {Examination whether numbers,
  composed from digits are prime}
  m4:=1; m:=0; n1:=k;
  For i:=1 to n1 do Nb3[i]:=g[i];
  Repeat
    Pd(m4,n1,n,nb3,nb4,nb5); Inc(m);
    If m4=1 Then Break; mm:=1;d:=0;
    For i:=1 to n1 do
      Begin
        d:=d+nb3[i]*mm; mm:=mm*10;
      End;
    If BelongToPrimes(d) Then Exit;
  Until False; PseudoPrime:=False;
End;

Var Ind,Num,i:Integer; List:pint;
Begin pl:=PrimeList(MaxN);
  {Generating list of primes up to MaxN}
  Ind:=0;Getmem(List,4*(MaxN shl 1));
  For Num:=10 to MN do
    If PseudoPrime(Num) Then
      {If number is pseudoprime then add it to list}
      Begin Inc(Ind);List^[Ind]:=Num; End;
      {Output generated numbers to 'Sp1' file,
      10 values per row}
      Assign(Output,'Sp1');Rewrite(Output);
      WriteLn(Ind);
      For i:=1 to Ind do
        Begin
          Write(List^[i]:7);
          If i mod 10=0 Then WriteLn;
        End;
      Close(output)
End.

```

Table 2. Pascal program 2 for generating Smarandache P_1 -series

```

Const MaxG=5;
Var c,d,r:Array[1..MaxG]Of Integer;
    g:Integer;

Function Sg(x:Integer):Integer;
Begin {function returns unit if argument is
greater than zero}
    If x>0 Then Sg:=1 Else Sg:=0;
End;

Function Fact(x:Integer):LongInt;
Var i:Integer;f:LongInt;
Begin {function calculates factorial of
argument}
    f:=1; For i:=1 to x do f:=f*i; Fact:=f;
End;

Function Lg(x:Extended):Extended;
Begin {function returns decimal logarithm of
argument}
    Lg:=Ln(x)/Ln(10);
End;

Function
Power(x:Extended;Deg:Integer):Extended;
Var p:Extended;i:Integer;
Begin {function returns argument in 'deg'
power}
    p:=1;For i:=1 to Deg do p:=p*x;
    Power:=p;
End;

Function Mu(p,g:Integer):Integer;
Var m,q:Integer;
{this is an auxiliary function}
Begin m:=1;
    For q:=1 to p do m:=m*(g-q+1); Mu:=m;
End;

Function GetPos(k,p:Integer):Integer;
Var i,f:Integer;
Begin
    {function returns location of element 'p'
in 'k'th permutation of 'g' objects}
    c[p]:=(k div Mu(p,g)) mod 2;
    f:=(k div Mu(p-1,g))mod (g-p+1);
    d[p]:=p-1+(1-c[p])*f+c[p]*(g-p-f);
    r[p]:=d[p];
    For i:=p-1 downto 1 do
        r[p]:=r[p]-Byte(d[i]>=r[p]); GetPos:=r[p];
    End;
End;

Function MXi(i:Integer):Integer;
Var k,q,p,s,Pro:Integer;
    Sum,c:Extended;
Begin
    {function returns unit if examined value '1'
{belongs to set of Smarandache numbers}
    S:=0;g:=Trunc(Lg(i))+1;
    For k:=0 to Fact(g)-1 do
        Begin
            {Construction number 'c' from permutated
            digits of number 'i'}
            sum:=0; For p:=1 to g do
                sum:=sum+(Int(i/Power(10,g-p))-
10*Int(i/Power(10,g-p+1)))/
                Power(10,GetPos(k,p));
            c:=Power(10,g-1)*sum;
            Pro:=1; {if 'c' is prime number}
            For q:=2 to Trunc(sqrt(c)) do
                Pro:=Pro*Sg(Round(c) mod q);
            s:=s+Pro;
        End; Mxi:=Sg(s);
    End;

Var xi,n,M:Integer;

Function BuildAn(n:Integer):Integer;
Var i,xi,a:Integer;
    m,Un,SumXi:LongInt;
Begin
    {function returns 'n'th element of
Smarandache sequence}
    a:=0;Un:=Sqr(LongInt(n));
    For m:=0 to Un do
        Begin
            {'SumXi' is quantity of Smarandache
numbers which are less than number 'm'}
            SumXi:=0; For i:=1 to m do
                SumXi:=SumXi+MXi(i);
            a:=a+sg(n-SumXi);
        End; BuildAn:=a;
    End;

Begin {Output of the first 'M' Smarandache
numbers}
    M:=30;
    For n:=1 to M do Write(BuildAn(n):5);
    WriteLn;
End.

```

The analytical formula available for determining n -th number in the P_1 -series is obtained from (7) when [6]

$$b = 2, \quad \chi_i = \text{sg} \left\{ \sum_{k=0}^{g^i-1} \prod_{q=2}^{\lfloor \sqrt{c} \rfloor} \text{sg}(c - q[c/q]) \right\}, \quad (9)$$

and g, c and r_p are calculated by the formulae

$$g = [\lg i] + 1, \quad c = 10^g \sum_{p=1}^g \left(\left[\frac{i}{10^{g-p}} \right] - 10 \left[\frac{i}{10^{g-p+1}} \right] \right) / 10^{g-p}, \quad (10)$$

$$r_p = z_1, \quad d_p = p - 1 + f(1 - c_p) + c_p(g - p - f), \quad c_p = \lfloor (-1)^{t_p} - 1 \rfloor / 2,$$

$$f = t_{p-1} - (g - p + 1) [t_{p-1} / (g - p + 1)], \quad t_p = \lfloor k / \prod_{q=1}^p (g - q + 1) \rfloor,$$

$$z_1 = z_2 - \text{sg}(1 + d_1 - z_2), \quad z_2 = z_3 - \text{sg}(1 + d_2 - z_3), \quad \dots,$$

$$z_{p-2} = z_{p-1} - \text{sg}(1 + d_{p-2} - z_{p-1}), \quad z_{p-1} = d_p - \text{sg}(1 + d_{p-1} - d_p).$$

Pascal program identical with the analytical description (9) – (10) of the algorithm, generating P_1 -series numbers, takes the form, shown in Table 2.

It should be noted that most part of Pascal text of program 2 consists of formulae (9) – (10). In other words, translating analytical descriptions of computational algorithms into computer languages requires noticeably less efforts than the translation of verbal descriptions. Therefore, our conclusion is that

if it is possible, one should provide the verbal descriptions of computational algorithms with the analytical ones, constructed, for instance, by using logical functions [5 – 7].

b) Smarandache P_2 -series

$$14, 16, 20, 30, 32, 34, 35, 38, 50, 70, 74, 76, 91, 92, 95, 98, \dots \quad (11)$$

contains the only such natural numbers, which are the composite numbers itself, but the prime numbers can be obtained from P_2 -series numbers by a permutation of digits. The analytical formula available for determining n -th number in the P_2 -series has the same form as for P_1 -series numbers, but in this case the value of χ_i from (9) is computed by the formula

$$\chi_i = (1 - w_0) \text{sg} \left(\sum_{k=1}^{g^i-1} w_k \right), \quad w_k = \prod_{q=2}^{\lfloor \sqrt{c} \rfloor} \text{sg}(c - q[c/q]). \quad (12)$$

3.2 Some Modifications of Eratosthenes Sieve

a) Smarandache T_1 -series

$$7, 13, 19, 23, 25, 31, 33, 37, 43, 47, 49, 53, 55, 61, 63, \dots \quad (13)$$

is obtained from the series of natural numbers by deleting all even numbers and all such odd numbers t_i that the numbers $t_i + 2$ are primes. The analytical formula for the determination of n -th number in the T_1 -series has the form (7) with

$$b = 2, \chi_i = (i - 2[i/2]) \left\{ 1 - \prod_{k=2}^{[i/2]+1} \text{sg}(i + 2 - k[(i+2)/k]) \right\}, \quad (14)$$

b) Smarandache T_2 -series

$$1, 3, 5, 9, 11, 13, 17, 21, 25, 27, 29, 33, 35, 37, 43, 49, \dots \quad (15)$$

This series may be obtained from the series of natural numbers by the following *step-procedure*:

On k -th step each 2^k -th numbers are deleted from the series of numbers constructed on $(k-1)$ -th step.

The analytical formula for the determination of n -th number in the T_2 -series has the form (7) with

$$\chi_i = \text{sg} \left(\prod_{k=1}^{[\log i]+1} \{x_k - 2^k [x_k / 2^k]\} \right), x_1 = i, x_{k+1} = x_k - [x_k / 2^k], \quad (16)$$

where $\log a$ is the logarithm of the number a to the base 2.

4 Algorithms for Solving Problems on Constructing Magic Squares 3x3 from Given Class of Numbers

Proposition 1. *A set of nine numbers is available for constructing Magic squares 3x3 only in the case if one succeeds to represent these nine numbers in the form of such three arithmetic progressions from 3 numbers whose differences are identical and the first terms of all three progressions are also forming an arithmetic progression.*

Proof. The general algebraic formula of Magic squares 3x3 is shown in figure 1(3) [2, 4]. The table 1(4) is obtained from table 1(3) by arranging its symbols. It is noteworthy that arithmetic progressions with the difference b are placed in the rows of the table 1(4), whereas ones, having the difference c , are located in its columns. Thus, the proof of Proposition 1 follows directly from the construction of tables 1(3) and/or 1(4).

1	2	3
4	5	6
7	8	9

(1)

$a + b + 2c$	a	$a + 2b + c$
$a + 2b$	$a + b + c$	$a + 2c$
$a + c$	$a + 2b + 2c$	$a + b$

(3)

1	2	4
3	5	7
6	8	9

(2)

a	$a + b$	$a + 2b$
$a + c$	$a + b + c$	$a + 2b + c$
$a + 2c$	$a + b + 2c$	$a + 2b + 2c$

(4)

Figure 1. To proofs of correctness of Proposition 1 and Algorithm 1:

(3) — the general algebraic formula of Magic squares 3x3; (4) — additional table of Magic squares 3x3; (1) ($c > 2b$) and (2) ($b < c < 2b$) — two possible arrangements of the nine increasing numbers in cells of the additional table (4).

By Proposition 1 and two possible arrangements of the nine increasing numbers in cells of the additional table 1(4), which are shown in figures 1(1) and 1(2), we may elaborate *algorithm 1* available for constructing Magic squares 3×3 from an arbitrarily given set of nine increasing numbers [2]:

1. Take two square tables 3×3 and arrange 9 testing numbers in them so as it is shown in figures 1(1) and 1(2).
2. Check whether three arithmetic progressions of Proposition 1 are in one of these square tables 3×3 .

It should be noted, if the problem on constructing the Magic square 3×3 from the given set of nine increasing numbers has the solution, then this solution is always unique with regard for rotations and mappings.

For finding all Magic squares 3×3 from a given class of numbers with the number f in its central cell, one may use the following *algorithm 2* [2, 4]

- a) write out the possible decompositions of the number $2f$ in the two summands of the following form:

$$2f = x_1(j) + x_2(j), \quad (17)$$

where j is the number of a decomposition and $x_1(j)$, $x_2(j)$ are the two numbers such that $x_1(j) < x_2(j)$ and both these numbers belong to the given class of numbers;

- b) in the complete set of various decompositions (17), fix one, having, for instance, the number k and, for this decomposition, determine the number $d(k)$: $d(k) = f - x_1(j)$;
- c) find all possible arithmetic progressions from 3 numbers with differences equal $d(k)$ among a set of numbers $\{x_1(j)\}$ without $x_1(k)$. If there are m such arithmetic progressions then there are m Magic squares 3×3 with the numbers $x_1(k)$ and $x_2(k)$ in its cells;
- d) repeat items (b) and (c) for other values of k .

5 Magic Squares 3×3 and 9×9 from Prime Numbers

Proposition 2. *A Magic square 3×3 can be constructed from prime numbers only in the case if the parameters b and c of the general algebraic formula 1(3) and/or additional table 1(4) are the numbers multiple of 6.*

Proof. The truth of Proposition 2 follows from Proposition 1 and Cantor theorem of Section 2.

Corollaries from Proposition 2 [2]:

1. By using prime numbers one cannot construct a Magic square 3×3 with one of the cells containing numbers 2 or 3.

2. All nine prime numbers of a Magic square 3×3 are either numbers of the form $6k - 1$ or have the form $6k + 1$.

Proposition 3 [2]. *With regard for rotations and mappings, the last digits of the prime numbers may be arranged in the cells of the additional table of a Magic square 3×3 only in such variants, which are shown in figure 2.*

Proof. To prove the truth of Proposition 3, we need the two more easily verified properties of the additional table 1(4).

1. In this table the sums of the symbols of the central row, central column and both diagonals are identical and coincide with the Magic constant of the general algebraic formula 1(3).

2. An arithmetic progression, consisting of three numbers, occurs not only in the rows and columns but also in each diagonal of the additional table.

Now let us place a prime number, for instance, ending by 1, into the central cell of the additional table 1(4). It is clear, that in this case the last digits of all other prime numbers of the additional table of a Magic square 3×3 must be such that their sums in the central column, central row and both diagonals would terminate by 3. Thus, only certain arrangements of the last digits of prime numbers are possible in the remaining cells of the additional table and all such variants are shown in figure 2.

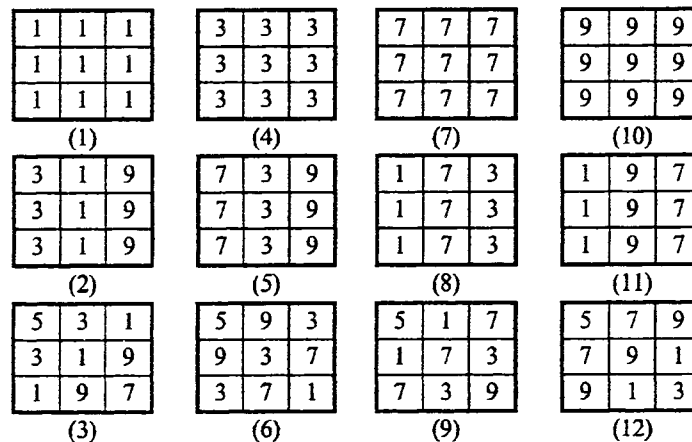

Figure 2. All possible arrangements of the last digits of the prime numbers in cells of the additional table 1(4).

Corollaries from Proposition 3 [2]:

1. Since 5 is a prime number having the form $6k - 1$, only the prime numbers of the form $6k - 1$ can be placed in cells of the additional table 1(4) with arrangements 2(3), 2(6), 2(9) and 2(12).

2. The arithmetic progression from three prime numbers a_k-30m, a_k, a_k+30m may be found among nine prime numbers of any Magic square 3×3 , where the number a_k is located in the central cell of the Magic square and m is some integer number. Hence it appears that

no Magic square 3×3 may be constructed from prime numbers if $a_k < 30$.

Let us consider some results of [2], obtained for prime numbers by computer.

1. Magic squares 3×3 , shown in figure 3, are the least ones, constructed only from prime numbers.

67	1	43
13	37	61
31	73	7

(1)

101	5	71
29	59	89
47	113	17

(2)

101	29	83
53	71	89
59	113	41

(3)

109	7	79
43	73	103
67	139	37

(4)

Figure 3. The least Magic squares 3×3 , constructed only from prime numbers.

2. Let it be required to construct a Magic square 3×3 only from prime numbers with the number a_k in its central cell. This problem cannot be solved only for the following prime numbers $a_k > 30$:

- a) having the form $6k - 1$: 41, 101; 53, 83, 113, 233; 47, 107, 197, 317; 569;
- b) having the form $6k + 1$: 31, 61, 181, 331; 43, 163, 223, 313, 433; 67, 97, 277, 457; 79, 199, 229, 439, 859.

3. The results of the item 2 make it possible to assume that, for any a_k larger than some prime number P_{\max} , one can always construct a Magic square 3×3 with Magic sum $S = 3a_k$ and the prime numbers, ending by the same digit as the number a_k . P_{\max} equals the following prime numbers:

- a) having the form $6k - 1$: 5081 (281); 3323 (683); 6257 (557); 3779 (359);
 - b) having the form $6k + 1$: 3931 (601); 3253 (523); 4297 (307); 7489 (769),
- where in brackets we indicate the least prime numbers a_k , for which one can construct a Magic square 3×3 with $S = 3a_k$ and the prime numbers, ending by the same digit as a_k .

4. Let it be required from prime numbers to construct a Magic square 9×9 , which contains the number a_k in its central cell and consists of 9 Magic squares 3×3 .

The example of the least Magic square 9×9 , constructed only from prime numbers and consisted of 9 Magic squares 3×3 , is shown in figure 4.

If $a_k > 1019$, then the problem on constructing Magic squares 9×9 , discussed in this item, cannot be solved only for following prime numbers a_k :

- 1021, 1031, 1033, 1039, 1049, 1051, 1061, 1069, 1087, 1091, 1093, (18)

1097, 1109, 1117, 1123, 1129, 1153, 1171, 1181, 1193, 1201, 1213,
 1217, 1229, 1231, 1237, 1249, 1259, 1279, 1283, 1303, 1307, 1321,
 1327, 1439, 1453, 1481, 1483, 1489, 1511, 1531, 1543, 1567, 1783.

2531	17	1409	1097	71	863	2069	23	1091
197	1319	2441	443	677	911	83	1061	2039
1229	2621	107	491	1283	257	1031	2099	53
1433	29	821	1811	137	1109	2153	311	1367
149	761	1373	317	1019	1721	491	1277	2063
701	1493	89	929	1901	227	1187	2243	401
1487	431	1013	2339	173	1571	1307	11	839
503	977	1451	593	1361	2129	251	719	1187
941	1523	467	1151	2549	383	599	1427	131

Figure 4. The example of the least Magic square 9×9 , constructed only from prime numbers and consisted of 9 Magic squares 3×3 .

6 Magic Squares 3×3 and 9×9 from Smarandache Numbers of the 2nd Kind

6.1 Magic Squares 3×3 and 9×9 from P_1 -Series Numbers

Let the notation $A_{C_j}(N)$ means the quantity of all C_j -series numbers, whose values are less than N , and the notation P_0 -series means the prime numbers series.

Proposition 4. For any natural number N the following inequality

$$A_{P_1}(N) \geq A_{P_0}(N) \quad (19)$$

is fulfilled

Proof. The truth of Proposition 4 follows from the description of P_1 -series numbers (see Section 3.1). Namely, P_0 -series numbers is subset of P_1 -series numbers at any N and agree with a set of P_1 -series numbers only if $N \leq 13$.

Proposition 5. P_1 -series numbers are available for constructing Magic squares 3×3 .

Proof. The truth of Proposition 5 follows from Proposition 4 and that the prime numbers are available for constructing Magic squares 3×3 (see Section 5).

Solving the problems on constructing Magic squares 3×3 from P_1 -series numbers by computer, we find that

1. Magic squares 3×3 , shown in figure 5, are the least ones, constructed from P_1 -series numbers.

47	5	35
17	29	41
23	53	11

(1)

50	11	35
17	32	47
29	53	14

(2)

53	11	41
23	35	47
29	59	17

(3)

50	17	38
23	35	47
32	53	20

(4)

Figure 5. The least Magic squares 3×3 , constructed from P_1 -series numbers.

2. Let it be required from P_1 -series numbers to construct a Magic square 3×3 with the number a_k in its central cell.

If $a_k > 35$, then this problem cannot be solved only for the following P_1 -series numbers: 38, 43, 47, 50 and 61.

3. Let it be required from P_1 -series numbers to construct a Magic square 9×9 , which contains the number a_k in its central cell and consists of 9 Magic squares 3×3 .

Magic square 9×9 , shown in figure 6, is the least such one, constructed from P_1 -series numbers.

We note, that

a) in the Magic square 9×9 , shown in figure 6, the numbers 215, 35, 143, 59, 203, 119, 227 and 47 may be replaced respectively by 203, 47, 143, 71, 191, 119, 215 and 59;

413	101	329	137	20	92	383	2	269
197	281	365	38	83	128	104	218	332
233	461	149	74	146	29	167	434	53
215	35	143	293	11	278	380	17	374
59	131	203	179	194	209	251	257	263
119	227	47	110	377	95	140	497	134
317	5	188	323	272	320	182	14	125
41	170	299	302	305	308	50	107	164
152	335	23	290	338	287	89	200	32

Figure 6. The least Magic square 9×9 , constructed from P_1 -series numbers and consisted of 9 Magic squares 3×3 .

b) if $a_k > 194$, then the problem on constructing Magic squares 9×9 , discussed in this point, cannot be solved only for following 10 P_1 -series numbers a_k : 196, 197, 199, 211, 214, 217, 223, 229, 232 and 300.

6.2 Magic Squares 3×3 and 9×9 from P_2 -Series Numbers

Proposition 6. For any natural number N the following inequality

$$A_{P_2}(N) < A_{P_1}(N) \quad (20)$$

is fulfilled

Proof. The truth of Proposition 6 follows from the description of P_2 -series numbers (see Section 3.2). Namely, P_2 -series numbers may be obtained by deleting all prime numbers from P_1 -series numbers.

It follows from Proposition 6 that, although we know about the availability of P_0 - and P_2 -series numbers for constructing Magic squares 3×3, we cannot state that P_2 -series numbers are also available for constructing Magic squares 3×3. To clear up this situation, let us consider our results, obtained for P_2 -series numbers by computer.

1. Magic squares 3×3, shown in figure 7, are the least ones, constructed from P_2 -series numbers.

152	14	110	164	50	143	203	20	134	215	20	140
50	92	134	98	119	140	50	119	188	50	125	200
74	170	32	95	188	74	104	218	35	110	230	35
(1)			(2)			(3)			(4)		

Figure 7. The least Magic squares 3×3, constructed from P_2 -series numbers.

2. Let it be required from P_2 -series numbers to construct a Magic square 3×3 with the number a_k in its central cell.

If $a_k = 92, 125, 441, 448, 652, 766$ or 928 , then this problem has a single solution.

If $a_k > 125$, then this problem cannot be solved only for the following P_2 -series numbers:

$$130, 142, 143, 145, 152, 160, 166, 169, 172, 175, 176, 190, 196, 232, \quad (21)$$

$$238, 289, 292, 298, 300, 301, 304, 319, 325, 382, 385, 391, 478, 517.$$

3. Let it be required from P_2 -series numbers to construct a Magic square 9×9, which contains the number a_k in its central cell and consists of 9 Magic squares 3×3.

If $a_k = 473$, then there are 609 the least Magic squares 9×9 with mentioned properties (the example of such Magic square is shown in figure 8).

If $a_k > 473$, then the problem on constructing Magic squares 9×9, discussed in this item, cannot be solved only for two P_2 -series numbers a_k : 478 and 517.

1007	140	578	374	278	344	830	74	632
146	575	1004	302	332	362	314	512	710
572	1010	143	320	386	290	392	950	194
785	32	413	728	20	671	902	14	692
38	410	782	416	473	530	326	536	746
407	788	35	275	926	218	380	1058	170
740	92	470	872	236	734	533	203	377
164	434	704	476	614	752	215	371	527
398	776	128	494	992	356	365	539	209

Figure 8. The example of the least Magic square 9×9 , constructed from P_2 -series numbers and consisted of 9 Magic squares 3×3 .

6.3 Magic Squares 3×3 and 9×9 from T_1 -Series Numbers

Proposition 7. *There exists such natural number N_0 that for any natural $N > N_0$ the following inequality*

$$A_{T_1}(N) > A_{P_0}(N) \quad (22)$$

is fulfilled

Proof. As it follows from the description of T_1 -series numbers (see Section 3.2), this series numbers may be obtained from series odd natural numbers by deleting all such odd numbers, which are prime numbers decreased by 2. Thus, we have the following relation

$$A_{T_1}(N) = (N-1)/2 - A_{P_0}(N) \quad \text{or} \quad A_{T_1}(N)/A_{P_0}(N) = \{(N-1)/2\}/A_{P_0}(N) - 1 \quad (23)$$

where the term $(N-1)/2$ is the quantity of all odd natural numbers, whose values are less than N . Since [8]

$$A_{P_0}(N) = N / \{\ln(N) + 1\} \pm N / \ln^2(N), \quad (24)$$

we obtain from (23) and (24) that

$$A_{T_1}(N)/A_{P_0}(N) \approx \ln(N)/2 - 1 > 2 \quad \text{for any } N > 500. \quad (25)$$

Thus, Proposition 7 is true, if N_0 , for instance, equals 500.

Proposition 8. *T_1 -series numbers are available for constructing Magic squares 3×3 .*

Proof. The truth of Proposition 8 follows from Proposition 7 and that the prime numbers are available for constructing Magic squares 3×3 .

Let us consider our results, obtained for T_1 -series numbers by computer.

1. Magic square 3×3 , shown in figure 9(1), is the least one, constructed from T_1 -series numbers.

49	7	37
19	31	43
25	55	13

(1)

83	13	63
33	53	73
43	93	23

(2)

117	19	89
47	75	103
61	131	33

(3)

185	31	141
75	119	163
97	207	53

(4)

Figure 9. Examples of Magic squares 3×3 , constructed from T_1 -series numbers.

2. Let it be required from T_1 -series numbers to construct a Magic square 3×3 with the number a_k in its central cell.

If $a_k = 53, 75$ or 119 , then this problem has a single solution {see figure 9(2 – 4)}.

If $a_k > 31$, then this problem cannot be solved only for two T_1 -series numbers: 33 and 47 .

3. Let it be required from T_1 -series numbers to construct a Magic square 9×9 , which contains the number a_k in its central cell and consists of 9 Magic squares 3×3 .

If $a_k = 181$, then there are 118 the least Magic squares 9×9 with mentioned properties (the example of such Magic square is shown in figure 10).

If $a_k > 181$, then the problem on constructing Magic squares 9×9 , discussed in this item, can be solved for all T_1 -series numbers a_k .

319	247	301	55	7	49	317	93	241
271	289	307	31	37	43	141	217	293
277	331	259	25	67	19	193	341	117
127	79	121	205	151	187	283	203	273
103	109	115	163	181	199	243	253	263
97	139	91	175	211	157	233	303	223
215	61	159	443	169	363	123	13	83
89	145	201	245	325	405	33	73	113
131	229	75	287	481	207	63	133	23

Figure 10. The example of the least Magic square 9×9 , constructed from T_1 -series numbers and consisted of 9 Magic squares 3×3 .

If $a_k = 181$, then there are 118 the least Magic squares 9×9 with mentioned properties (the example of such Magic square is shown in figure 10).

If $a_k > 181$, then the problem on constructing Magic squares 9×9 , discussed in this item, can be solved for all T_1 -series numbers a_k .

6.4 Magic Squares 3×3 and 9×9 from T_2 -Series Numbers

Proposition 9. *There exists such natural number N_0 that for any natural $N > N_0$ the following inequality*

$$A_{T_2}(N) > A_{p_0}(N) \quad (26)$$

is fulfilled

Proof. As it follows from the description of T_2 -series numbers (see Section 3.2), this series numbers may be obtained from series natural numbers by deleting all 2^k -th numbers on each k -th step of step-procedure (sieve). Thus, we have the following relation

$$\begin{aligned} A_{T_2}(N) &= N - N \prod_{k=1}^{\lfloor \log(N) \rfloor} 1/2^k \approx N(1 - 2/\{\log(N) (\log(N)+1)\}) \approx \\ &\approx N(1 - 2.9/\{\ln(N) (1.44 \ln(N) + 1)\}). \end{aligned} \quad (27)$$

We obtain from (24) and (27) that

$$A_{T_1}(N)/A_{p_0}(N) \approx \ln(N) > 2 \text{ for any } N > 20. \quad (28)$$

Thus, Proposition 9 is true, if N_0 , for instance, equals 20.

Proposition 10. *T_2 -series numbers are available for constructing Magic squares 3×3.*

Proof. The truth of Proposition 10 follows from Proposition 9 and that the prime numbers are available for constructing Magic squares 3×3.

Our computations give the following results:

1. Magic squares 3×3, shown in figure 11, are the least ones, constructed from T_2 -series numbers.

29	1	21	33	5	25	51	1	29	43	1	33	43	5	33
9	17	25	13	21	29	5	27	49	17	27	37	17	27	37
13	33	5	17	37	9	25	53	3	21	53	11	21	49	11
(1)			(2)			(3)			(4)			(5)		

Figure 11. The least Magic squares 3×3, constructed from T_2 -series numbers.

2. Let it be required from T_2 -series numbers to construct a Magic square 3×3 with the number a_k in its central cell.

If $a_k > 27$, then this problem cannot be solved only for two T_2 -series numbers: 37 and 49.

3. Let it be required from T_1 -series numbers to construct a Magic square 9×9, which contains the number a_k in its central cell and consists of 9 Magic squares 3×3.

395	11	299	265	17	153	373	5	237
139	235	331	33	145	257	69	205	341
171	459	75	137	273	25	173	405	37
249	29	197	325	1	259	397	9	269
113	165	217	129	195	261	97	225	353
133	301	81	131	389	65	181	441	53
321	13	221	401	21	313	251	27	187
85	185	285	157	245	333	91	155	219
149	357	49	177	469	89	123	283	59

Figure 12. The example of the least Magic square 9×9 , constructed from T_2 -series numbers and consisted of 9 Magic squares 3×3 .

If $a_k = 195$, then there are 6 the least Magic squares 9×9 with mentioned properties (the example of such Magic square is shown in figure 12).

If $a_k > 195$, then the problem on constructing Magic squares 9×9 , discussed in this point, cannot be solved only for the following P_2 -series numbers a_k :

$$197, 201, 205, 213, 213, 217, 221, 225, 229, 237, \quad (29)$$

$$245, 249, 257, 261, 269.$$

7 Concluding Remarks

As it is demonstrated in this paper, preliminary theoretical analysis of number-theoretic and combinatorial problems is always useful. In particular, the results of this analysis are able sometimes to provide investigators with valuable information, facilitating considerably the solution of all such of practical tasks, which are enumerated in Section 1. We hope, that the technique of theoretical analysis, elaborated in the paper, will become useful tool of investigators, occupied in the considered problems.

References

1. W.S. Andrews, H.A. Sayles, Magic squares made with prime numbers to have the lowest possible summations. *The Monist* (1913) 23 (4)
2. Y.V. Chebrakov, *Magic squares. Number theory, algebra, combinatorial analysis* (St.-Petersburg State Technical University Press, St.-Petersburg, 1998)
3. —, Analytical formulae and algorithms for constructing Magic squares from an arbitrary set of 16 numbers. *Smarandache Notions J.* (1997) 8 (1-2-3) 184-201
(see also web-site <http://www.pse.che.tohoku.ac.jp/~msuzuki/MagicSquare.html>)

4. —, Advance of Smarandache approach to solving systems of Diophantine equations. *Smarandache Notions J.* (2000) **11** (1-2-3) 144-155.
5. Y.V. Chebrakov, V.V. Shmagin, The analytical formulae yielding some Smarandache numbers and applications in Magic squares theory. *Smarandache Notions J.* (1997) **8** (1-2-3) 62-71.
6. —, Analytical approach to description of some combinatorial and number-theoretic computative algorithms. *Smarandache Notions J.* (2000) **11** (1-2-3) 156-164.
7. —, Computer-oriented methods for numerical solving combinatorial problems on partitions. *Smarandache Notions J.* (see this Issue)
8. P.L. Chebyshev, On determining the quantity of prime numbers. On prime numbers. In: *Complete edition of Chebyshev's works* (Akad. Nauk SSSR, Moscow, 1964)
9. C. Dumitrescu, V. Seleacu, *Some notions and questions in number theory* (Erhus University Press, Vail, 1995)
(see also web-site <http://www.gallup.unm.edu/~smarandache/>)
10. W. Sierpinsky, *Elementary theory of numbers* (Polska Akad. Nauk., Warszawa, 1964)
11. I.M. Vinogradov *Foundation of the theory of numbers* (Moscow, Nauka, 1981)

On Smarandache sequences and subsequences

Tiang Zhengping

Xu Kanghua

(Hangzhou Teacher's College, Fuyang No.2 Middle School, Zhejiang, P. R. China)

Abstract A Smarandache sequence partial perfect additive sequence is studied completely in the first paragraph. In the second paragraph both Smarandache square-digital subsequence and square-partial-digital subsequence are studied.

Key words Smarandache partial perfect additive sequence, Smarandache square-digital subsequence, Smarandache square-partial-digital subsequence.

§1 Smarandache partial perfect additive sequence

The Smarandache partial perfect additive sequence is defined to be a sequence: 1, 1, 0, 2, -1, 1, 1, 3, -2, 0, 0, 2, 0, 2, 2, 4, -3, -1, -1, 1, -1, 1, 1, 3, -1, 1, ...

This sequence has the property that:

$$\sum_{i=1}^p a_i = \sum_{j=p+1}^{2p} a_j, \quad \text{for all } p \geq 1.$$

It is constructed in the following way:

$$a_1 = a_2 = 1,$$

$$a_{2p+1} = a_{p+1} - 1,$$

and $a_{2p+2} = a_{p+1} + 1$ for all $p \geq 1$.

In [1] M. Bencze raised the following two questions:

(a) Can you, readers, find a general expression of a_n (as function of n)?

Is it periodical or convergent or bounded?

(b) Please design (invent) yourselves other Smarandache perfect (or partial perfect) f-sequences.

In this paper we solved the question (a) completely.

Suppose the binary notation of $n(n \geq 2)$ as $n = (\varepsilon_k \varepsilon_{k-1} \cdots \varepsilon_1 \varepsilon_0)_2$, among which $\varepsilon_k = 1, \varepsilon_i = 0$ or 1 ($i = 0, 1, \dots, k-1$). Define $f(n)$ are the numbers of $\varepsilon_i = 1 (i = 0, 1, \dots, k)$, $g(n)$ is the minimum of i that makes $\varepsilon_i = 1$.

Thus we may prove the expression of $a(n)$ (i.e. a_n) as the following:

$$a(n) = \begin{cases} k, & \text{if } \varepsilon_0 = \varepsilon_1 = \cdots = \varepsilon_{k-1} = 0, \\ -k + 2f(n) + 2g(n) - 3 & \text{otherwise} \end{cases}$$

We may use mathematical induction to prove it.

$$a(2) = 1, a(3) = 0 = -1 + 2 \times 2 + 2 \times 0 - 3 = -1 + 2f(3) + 2g(3) - 3.$$

So the conclusion is valid for $n = 2, 3$,

Suppose that the conclusion is also valid for $2, 3, \dots, n-1 (n \geq 3)$. Let's consider the cases of n .

1 When $\varepsilon_0 = \varepsilon_1 = \cdots = \varepsilon_{k-1} = 0$.

$$\begin{aligned} a(n) &= a((\varepsilon_k \varepsilon_{k-1} \cdots \varepsilon_1 \varepsilon_0)_2) = a((\varepsilon_k \varepsilon_{k-1} \cdots \varepsilon_1) + 1) \\ &= k - 1 + 1 = k. \end{aligned}$$

2 When not all the $\varepsilon_0, \varepsilon_1, \dots, \varepsilon_{k-1}$ are zeroes, two kinds of cases should be discussed.

(1) If $\varepsilon_0 = 0$.

$$\text{Then } f(n) = f((\varepsilon_k \varepsilon_{k-1} \cdots \varepsilon_1 \varepsilon_0)_2) = f((\varepsilon_k \varepsilon_{k-1} \cdots \varepsilon_1)_2) = f\left(\frac{n}{2}\right),$$

$$g(n) = g((\varepsilon_k \varepsilon_{k-1} \cdots \varepsilon_1 \varepsilon_0)_2) = g((\varepsilon_k \varepsilon_{k-1} \cdots \varepsilon_1)_2) + 1 = g\left(\frac{n}{2}\right) + 1.$$

According to inductive hypothesis, we have

$$\begin{aligned} a(n) &= a\left(\frac{n}{2}\right) + 1 = -(k-1) + 2f\left(\frac{n}{2}\right) + 2g\left(\frac{n}{2}\right) - 3 + 1 \\ &= -k + 2f(n) + 2(g(n) - 1) - 1 \\ &= -k + 2f(n) + 2g(n) - 3. \end{aligned}$$

(2) If $\varepsilon_0 = 1$, three subcases exist

(i) If $\varepsilon_1 = 0$.

$$\text{Then } f(n) = f((\varepsilon_k \varepsilon_{k-1} \cdots \varepsilon_1 \varepsilon_0)_2) = f((\varepsilon_k \varepsilon_{k-1} \cdots \varepsilon_2 1)_2)$$

$$= f\left(\left\lfloor \frac{n}{2} \right\rfloor + 1\right), \text{ the notation } [x] \text{ denotes the greatest integer not}$$

more than x .

$$g(n) = g((\varepsilon_k \varepsilon_{k-1} \cdots \varepsilon_1 \varepsilon_0)_2) = g((\varepsilon_k \varepsilon_{k-1} \cdots \varepsilon_2 1)_2) = g\left(\left\lfloor \frac{n}{2} \right\rfloor + 1\right) + 1 = 0.$$

so, it's easily known from inductive hypothesis

$$\begin{aligned} a(n) &= a\left(\left\lfloor \frac{n}{2} \right\rfloor + 1\right) - 1 = -(k-1) + 2f\left(\left\lfloor \frac{n}{2} \right\rfloor + 1\right) + 2g\left(\left\lfloor \frac{n}{2} \right\rfloor + 1\right) - 3 - 1 \\ &= -k + 2f(n) + 2g(n) - 3. \end{aligned}$$

(ii) If $\varepsilon_1 = \varepsilon_2 = \cdots = \varepsilon_i = 1, \varepsilon_{i+1} = 0, 1 \leq i \leq k-2$.

$$n = (\varepsilon_k \varepsilon_{k-1} \cdots \varepsilon_1 \varepsilon_0)_2, \quad \left\lfloor \frac{n}{2} \right\rfloor + 1 = (\varepsilon_k \varepsilon_{k-1} \cdots \varepsilon_{i+2} \varepsilon_{i+1} \varepsilon_i \cdots \varepsilon_2 \varepsilon_1)_2 + (1)_2$$

$$= (\varepsilon_k \varepsilon_{k-1} \cdots \varepsilon_{i+2} \underbrace{100 \cdots 0}_{i \text{ times}})_2.$$

So, $f\left(\left\lfloor \frac{n}{2} \right\rfloor + 1\right) = f(n) - i$, $g\left(\left\lfloor \frac{n}{2} \right\rfloor + 1\right) = i = i + g(n)$.

Then, According to inductive hypothesis, we have

$$\begin{aligned} a(n) &= a\left(\left\lfloor \frac{n}{2} \right\rfloor + 1\right) - 1 = -(k-1) + 2f\left(\left\lfloor \frac{n}{2} \right\rfloor + 1\right) + 2g\left(\left\lfloor \frac{n}{2} \right\rfloor + 1\right) - 3 - 1 \\ &= -k + 2(f(n) - i) + 2(i + g(n)) - 3 \\ &= -k + 2f(n) + 2g(n) - 3. \end{aligned}$$

(iii) If $\varepsilon_1 = \varepsilon_2 = \cdots = \varepsilon_{k-1} = \varepsilon_k = 1$, then

$$\begin{aligned} f(n) &= k+1, \quad g(n) = 0. \quad \left\lfloor \frac{n}{2} \right\rfloor + 1 = (\varepsilon_k \varepsilon_{k-1} \cdots \varepsilon_2 \varepsilon_1)_2 + (1)_2 \\ &= \underbrace{(100 \cdots 0)}_{k \text{ times}}_2, \quad \text{so from 1} \end{aligned}$$

$$a\left(\left\lfloor \frac{n}{2} \right\rfloor + 1\right) = k.$$

Then
$$\begin{aligned} a(n) &= a\left(\left\lfloor \frac{n}{2} \right\rfloor + 1\right) - 1 = k - 1 \\ &= -k + 2(k+1) + 2 \times 0 - 3 = -k + 2f(n) + 2g(n) - 3. \end{aligned}$$

From the above, the conclusion is true for all the natural numbers $n(n \geq 2)$.

Having proved above fact, the remaining problem in question (a) can be solved easily. For if $n = 2^k$, we have $a(n) = k$, so sequence $\{a(n)\}$ is unbounded, therefore cannot be periodical and convergent.

§ 2 Smaranche square-digital subsequence and Smaranche square-partial-digital subsequence

The Smaranche square-digital subsequence is defined to be a subsequence:

0, 1, 4, 9, 49, 100, 144, 400, 441, ...

i.e. from 0, 1, 4, 9, 16, 25, 36, ..., n^2 , ... we choose only the terms those digits are all perfect squares (Therefore only 0, 1, 4 and 9)

In [1] M.Bencze questioned: Disregarding the square numbers of the form $\overbrace{N0\dots0}^{2k \text{ times}}$, where N is also a perfect square, how many other numbers belong to this sequence?

We find that 1444, 11449, 491401, also belong to the sequence by calculating.

In fact, we may find infinitely many numbers that belong to the sequence.

$$(2 \cdot 10^k + 1)^2 = 4 \cdot 10^{2k} + 4 \cdot 10^k + 1,$$

$$(10^k + 2)^2 = 10^{2k} + 4 \cdot 10^k + 4 \quad \text{for all } k \geq 1.$$

Smarandache square-partial-digital subsequence is defined to be a sequence:

49, 100, 144, 169, 400, 441, ...

i.e. the square numbers that can be partitioned into groups of digits which are also perfect squares (169 can be partitioned as $16 = 4^2$ and $9 = 3^2$, etc.).

In the same way it is questioned: Disregarding the square numbers of the form $\overbrace{N0\dots0}^{2k \text{ times}}$, where N is also a perfect square, how many other numbers belong to this sequence?

We may find 22 numbers in the form $\overline{a0b^2}$ (here neither a or b is zero).

10404, 11025, 11449, 11664, 40401, 41616, 42025, 43681,
 93025, 93636, 161604, 164025, 166464, 251001, 254016, 259081,
 363609, 491401, 641601, 646416, 813604, 819025.

We may construct infinitely many numbers by adding zero in the middle of these numbers like 102^2 , 105^2 , 107^2 , 108^2 , 201^2 , 204^2 , 205^2 , 209^2 , 305^2 , 306^2 , 402^2 , 405^2 , 408^2 , 501^2 , 504^2 , 509^2 , 603^2 , 701^2 , 801^2 , 804^2 , 902^2 , 905^2 as well. we may find some other numbers as the following:

3243601, 10246401, 2566404, 1036324, 4064256, 36144144, 49196196,
81324324, 64256256, 121484484, 169676676, 196784784, 484484121,
576576144, 676676169, 784784196, 900900225, 1442401, 3243601, 4004001,
4844401, 10246401, 20259001, 24019801, 25010001, 49014001, 64016001.

§ 3 Smaranche cube-partial-digital subsequence

1000, 8000, 10648, 27000, ...

i.e. the cube numbers that can be partitioned into groups of digits which are also perfect cubes (10648 can be partitioned as $1 = 1^3, 0 = 0^3, 64 = 4^3$, and $8 = 2^3$)

Same question: disregarding the cube numbers of the form: $\overline{M \underbrace{0 \dots 0}_{3k \text{ times}}}$, where M is also a perfect cube, how many other numbers belong to this sequence?

As the above said, we may find infinitely many numbers that belong to the sequence as well

$$(3 \cdot 10^{k+2} + 3)^3, (6 \cdot 10^{k+3} + 1)^3, (6 \cdot 10^{k+3} + 6)^3, (10^{k+3} + 6)^3 \quad \text{for all } k \geq 0$$

for example $\underline{27818127} = 303^3$, $\underline{216648648216} = 6006^3$,

$$\underline{216108018001} = 6001^3, \underline{1018108216} = 1006^3 .$$

REFERENCES

1. Bencze, M.(1998). "Smarandache Relationships and Subsequences", *Bulletin of Pure and Applied Sciences*. Vol. 17E (N0.1) 1998; P.55-62.

On three problems concerning the Smarandache LCM sequence

Felice Russo

Via A. Infante 7

67051 Avezano (Aq) Italy

felice.russo@katamail.com

Abstract

In this paper three problems posed in [1] and concerning the Smarandache LCM sequence have been analysed.

Introduction

In [1] the Smarandache LCM sequence is defined as the least common multiple (LCM) of $(1, 2, 3, \dots, n)$:

1, 2, 6, 12, 60, 60, 420, 840, 2520, 2520, 27720, 27720, 360360, 360360, 360360, 720720

In the same paper the following three problems are reported:

1. *If $a(n)$ is the n -th term of the Smarandache LCM sequence, how many terms in the new sequence obtained taking $a(n)+1$ are prime numbers?*

2. *Evaluate $\lim_{n \rightarrow \infty} \sum_n \frac{a(n)}{n!}$ where $a(n)$ is the n -th term of the Smarandache LCM sequence*

3. *Evaluate $\lim_{n \rightarrow \infty} \sum_n \frac{1}{a(n)}$ where $a(n)$ is the n -th term of the Smarandache LCM sequence*

In this paper we analyse those three questions.

Results

Problem 1.

Thanks to a computer programs written with Ubasic software package the first 50 terms of sequence $a(n)+1$, where $a(n)$ is the n -th term of Smarandache LCM sequence, have been checked. Only 10 primes have been found excluding the repeating terms.

In the following the sequence of values of $n \leq 50$ such that $a(n)+1$ is prime is reported:

$$2, 3, 4, 5, 7, 9, 19, 25, 32, 47$$

According to those experimental data the percentage of primes is:

$$\frac{10}{24} \approx 41.7\%$$

We considered 24 instead of 50 because we have excluded all the repeating terms in the sequence $a(n)$ as already mentioned before. Based on that result the following conjecture can be formulated:

Conjecture: *The number of primes generated by terms of Smarandache LCM sequence plus 1 is infinite.*

Problem 2.

By using a Ubasic program we have found:

$$\lim_{n \rightarrow \infty} \sum_n \frac{a(n)}{n!} \approx \sum_{n=1}^{\infty} \frac{1}{32 \cdot n^2 + 20 \cdot n - 11} = 4.195953\dots$$

Problem 3.

Always thanks to a Ubasic program the convergence value has been evaluated:

$$\lim_{n \rightarrow \infty} \sum_n \frac{1}{a(n)} \approx \ln \frac{27773}{27281} = 1.7873\dots$$

where 27773 and 27281 are both prime numbers.

References.

[1] A. Murthy, *Some new Smarandache sequences, functions and partitions*, Smarandache Notions Journal, Vol. 11 N. 1-2-3 Spring 2000.

On a problem concerning the Smarandache Unary sequence

Felice Russo

Via A. Infante 7

67051 Avezzano (Aq) Italy

felice.russo@katamail.com

Abstract

In this paper a problem posed in [1] and concerning the number of primes in the Smarandache Unary sequence is analysed.

Introduction

In [1] the Smarandache Unary sequence is defined as the sequence obtained concatenating p_n digits of 1, where p_n is the n -th prime number:

11, 111, 11111, 1111111, 1111111111, 111111111111, 1111111111111, 111111111111111,

In the same paper the following open question is reported:

How many terms in the Smarandache Unary sequence are prime numbers?

In this paper we analyse that question and a conjecture on the number of primes belonging to the Smarandache Unary sequence is formulated.

Results

A computer program with Ubasic software package has been written to check the first 311 terms of the Unary sequence; we have found only five prime numbers. If we indicate the n -th term of the unary sequence as:

$$u(n) = \frac{10^{p_n} - 1}{9} \quad \text{where } p_n \text{ is the } n\text{-th prime.}$$

those five primes have been found for p_n equal to 2, 19, 23, 317 and 1031.

This means a percentage of $\frac{5}{311} \approx 1.6\%$ prime numbers. According to this experimental evidence the following conjecture can be formulated:

Conjecture: The number of primes in the Smarandache Unary sequence is upper limited.

Unsolved question: Find that upper limit.

References.

[1] F. Iacobescu, *Smarandache Partition type and other sequences*, Smarandache Notions Journal, Vol. 11 N. 1-2-3 Spring 2000

An introduction to the Smarandache Double factorial function

Felice Russo
Via A. Infante 7
 67051 Avezzano (Aq) Italy

In [1], [2] and [3] the Smarandache Double factorial function is defined as:

Sdf(n) is the smallest number such that Sdf(n)!! is divisible by n, where the double factorial is given by [4]:

$$m!! = 1 \times 3 \times 5 \times \dots \times m, \text{ if } m \text{ is odd};$$

$$m!! = 2 \times 4 \times 6 \times \dots \times m, \text{ if } m \text{ is even}.$$

In this paper we will study this function and several examples, theorems, conjectures and problems will be presented. The behaviour of this function is similar to the other Smarandache functions introduced in the chapter I.

In the table below the first 100 values of function Sdf(n) are given:

n	Sdf(n)	n	Sdf(n)	n	Sdf(n)	n	Sdf(n)	n	Sdf(n)
1	1	21	7	41	41	61	61	81	15
2	2	22	22	42	14	62	62	82	82
3	3	23	23	43	43	63	9	83	83
4	4	24	6	44	22	64	8	84	14
5	5	25	15	45	9	65	13	85	17
6	6	26	26	46	46	66	22	86	86
7	7	27	9	47	47	67	67	87	29
8	4	28	14	48	6	68	34	88	22
9	9	29	29	49	21	69	23	89	89
10	10	30	10	50	20	70	14	90	12
11	11	31	31	51	17	71	71	91	13
12	6	32	8	52	26	72	12	92	46
13	13	33	11	53	53	73	73	93	31
14	14	34	34	54	18	74	74	94	94
15	5	35	7	55	11	75	15	95	19
16	6	36	12	56	14	76	38	96	8
17	17	37	37	57	19	77	11	97	97
18	12	38	38	58	58	78	26	98	28
19	19	39	13	59	59	79	79	99	11
20	10	40	10	60	10	80	10	100	20

According to the experimental data the following two conjectures can be formulated:

Conjecture 4.1 The series $\sum_{n=1}^{\infty} Sdf(n)$ is asymptotically equal to $a \cdot n^b$ where a and b are close to 0.8834.. and 1.759.. respectively.

Conjecture 4.2 The series $\sum_{n=1}^{\infty} \frac{1}{Sdf(n)}$ is asymptotically equal to $a \cdot n^b$ where a and b are close to 0.9411.. and 0.49.. respectively.

Let's start now with the proof of some theorems.

Theorem 4.1. $Sdf(p)=p$ where p is any prime number.

Proof. For $p=2$, of course $Sdf(2)=2$. For p odd instead observes that only for $m=p$ the factorial of first m odd integers is a multiple of p , that is $1 \cdot 3 \cdot 5 \cdot 7 \dots p = (p-2)!! \cdot p$.

Theorem 4.2. For any squarefree even number n ,

$$Sdf(n) = 2 \cdot \max\{p_1, p_2, p_3, \dots, p_k\}$$
where $p_1, p_2, p_3, \dots, p_k$ are the prime factors of n .

Proof. Without loss of generality let's suppose that $n = p_1 \cdot p_2 \cdot p_3$ where $p_3 > p_2 > p_1$ and $p_1 = 2$. Given that the factorial of even integers must be a multiple of n of course the smallest integer m such that $2 \cdot 4 \cdot 6 \dots \cdot m$ is divisible by n is $2 \cdot p_3$. Infact for $m = 2 \cdot p_3$ we have :

$$2 \cdot 4 \cdot 6 \dots 2 \cdot p_2 \cdot 2 \cdot p_3 = (2 \cdot p_2 \cdot p_3) \cdot (4 \cdot 6 \dots 2k \cdot 2) = k \cdot (2 \cdot p_2 \cdot p_3) \text{ where } k \in \mathbb{N}$$

Theorem 4.3. For any squarefree composite odd number n ,
 $Sdf(n) = \max\{p_1, p_2, \dots, p_k\}$ where p_1, p_2, \dots, p_k are the prime factors of n .

Proof. Without loss of generality let suppose that $n = p_1 \cdot p_2$ where p_1 and p_2 are two distinct primes and $p_2 > p_1$. Of course the factorial of odd integers up to p_2 is a multiple of n because being $p_1 < p_2$ the factorial will contain the product $p_1 \cdot p_2$ and therefore $n \mid 1 \cdot 3 \cdot 5 \cdot \dots \cdot p_1 \cdot p_2$.

Theorem 4.4. $\sum_{n=1}^{\infty} \frac{1}{Sdf(n)}$ diverges.

Proof. This theorem is a direct consequence of the divergence of sum $\sum_p \frac{1}{p}$ where p is any prime number.

In fact $\sum_{k=1}^{\infty} \frac{1}{Sdf(k)} > \sum_{p=2}^{\infty} \frac{1}{p}$ according to the theorem 4.1 and this proves the theorem.

Theorem 4.5 The $Sdf(n)$ function is not additive that is $Sdf(n+m) \neq Sdf(n) + Sdf(m)$ for $(n,m) = 1$.

Proof. In fact for example $Sdf(2+15) \neq Sdf(2) + Sdf(15)$.

Theorem 4.6 The $Sdf(n)$ function is not multiplicative, that is $Sdf(n \cdot m) \neq Sdf(n) \cdot Sdf(m)$ for $(n,m) = 1$.

Proof. In fact for example $Sdf(3 \cdot 4) \neq Sdf(3) \cdot Sdf(4)$.

Theorem 4.7 $Sdf(n) \leq n$

Proof. If n is a squarefree number then based on theorems 4.1, 4.2 and 4.3 $Sdf(n) \leq n$. Let's now consider the case when n is not a squarefree number. Of course the maximum value of the $Sdf(n)$ function cannot be larger than n because when we arrive in the factorial to n for sure it is a multiple of n .

Theorem 4.8 $\sum_{n=1}^{\infty} \frac{Sdf(n)}{n}$ diverges.

Proof. In fact $\sum_{k=1}^{\infty} \frac{Sdf(k)}{k} > \sum_{p=2}^{\infty} \frac{Sdf(p)}{p}$ where p is any prime number and of course $\sum_p \frac{Sdf(p)}{p}$ diverges because the number of primes is infinite [5] and $Sdf(p)=p$.

Theorem 4.9 $Sdf(n) \geq 1$ for $n \geq 1$

Proof. This theorem is a direct consequence of the $Sdf(n)$ function definition. In fact for $n=1$, the smallest m such that 1 divide $Sdf(1)$ is trivially 1. For $n \neq 1$, m must be greater than 1 because the factorial of 1 cannot be a multiple of n .

Theorem 4.10 $0 < \frac{Sdf(n)}{n} \leq 1$ for $n \geq 1$

Proof. The theorem is a direct consequence of theorem 4.7 and 4.9.

Theorem 4.11 $Sdf(p_k\#) = 2 \cdot p_k$ where $p_k\#$ is the product of first k primes (primorial) [4].

Proof. The theorem is a direct consequence of theorem 4.2.

Theorem 4.12 The equation $\frac{Sdf(n)}{n} = 1$ has an infinite number of solutions.

Proof. The theorem is a direct consequence of theorem 4.1 and the well-known fact that there is an infinite number of prime numbers [5].

Theorem 4.13 The even (odd respectively) numbers are invariant under the application of Sdf function, namely $Sdf(\text{even})=\text{even}$ and $Sdf(\text{odd})=\text{odd}$

Proof. Of course this theorem is a direct consequence of the Sdf(n) function definition.

Theorem 4.14 The diophantine equation $Sdf(n) = Sdf(n+1)$ doesn't admit solutions.

Proof. In fact according to the previous theorem if n is even (odd respectively) then Sdf(n) also is even (odd respectively). Therefore the equation $Sdf(n)=Sdf(n+1)$ can not be satisfied because Sdf(n) that is even should be equal to Sdf(n+1) that instead is odd.

Conjecture 4.3 The function $\frac{Sdf(n)}{n}$ is not distributed uniformly in the interval]0,1].

Conjecture 4.4 For any arbitrary real number $\varepsilon > 0$, there is some number $n \geq 1$ such that $\frac{Sdf(n)}{n} < \varepsilon$

Let's now start with some problems related to the Sdf(n) function.

Problem 1. Use the notation $FSdf(n)=m$ to denote, as already done for the $Zt(n)$ and $Zw(n)$ functions, that m is the number of different integers k such that $Zw(k)=n$.

Example $FSdf(1)=1$ since $Sdf(1)=1$ and there are no other numbers n such that $Sdf(n)=1$

Study the function $Fsdf(n)$.

Evaluate $\lim_{m \rightarrow \infty} \frac{\sum_{k=1}^m \frac{FSdf(k)}{k}}{m}$

Problem 2. *Is the difference $|Sdf(n+1)-Sdf(n)|$ bounded or unbounded?*

Problem 3. *Find the solutions of the equations: $\frac{Sdf(n+1)}{Sdf(n)} = k = \frac{Sdf(n)}{Sdf(n+1)}$ where k is any positive integer and $n > 1$ for the first equation.*

Conjecture 4.5 *The previous equations don't admits solutions.*

Problem 4. *Analyze the iteration of $Sdf(n)$ for all values of n . For iteration we intend the repeated application of $Sdf(n)$. For example the k -th iteration of $Sdf(n)$ is:*

$$Sdf^k(n) = Sdf(Sdf(\dots(Sdf(n))\dots)) \quad \text{where } Sdf \text{ is repeated } k \text{ times.}$$

For all values of n , will each iteration of $Sdf(n)$ produces always a fixed point or a cycle?

Problem 5. *Find the smallest k such that between $Sdf(n)$ and $Sdf(k+n)$, for $n > 1$, there is at least a prime.*

Problem 6. *Is the number $0.1232567491011\dots$ where the sequence of digits is $Sdf(n)$ for $n \geq 1$ an irrational or transcendental number? (We call this number the Pseudo-Smarandache-Double Factorial constant).*

Problem 7. *Is the Smarandache Euler-Mascheroni sum (see chapter II for definition) convergent for $Sdf(n)$ numbers? If yes evaluate the convergence value.*

Problem 8. Evaluate $\sum_{k=1}^{\infty} (-1)^k \cdot Sdf(k)^{-1}$

Problem 9. Evaluate $\prod_{n=1}^{\infty} \frac{1}{Sdf(n)}$

Problem 10. Evaluate $\lim_{k \rightarrow \infty} \frac{Sdf(k)}{\theta(k)}$ where $\theta(k) = \sum_{n \leq k} \ln(Sdf(n))$

Problem 11. Are there m, n, k non-null positive integers for which $Sdf(n \cdot m) = m^k \cdot Sdf(n)$?

Problem 12. Are there integers $k > 1$ and $n > 1$ such that $(Sdf(n))^k = k \cdot Sdf(n \cdot k)$?

Problem 13. Solve the problems from 1 up to 6 already formulated for the $Zw(n)$ function also for the $Sdf(n)$ function.

Problem 14. Find all the solution of the equation $Sdf(n)! = Sdf(n!)$

Problem 15. Find all the solutions of the equation $Sdf(n^k) = k \cdot Sdf(n)$ for $k > 1$ and $n > 1$.

Problem 16. Find all the solutions of the equation $Sdf(n^k) = n \cdot Sdf(k)$ for $k > 1$.

Problem 17. Find all the solutions of the equation $Sdf(n^k) = n^m \cdot Sdf(m)$ where $k > 1$ and $n, m > 0$.

Problem 18. For the first values of the $Sdf(n)$ function the following inequality is true:

$$\frac{n}{Sdf(n)} \leq \frac{1}{8} \cdot n + 2 \quad \text{for } 1 \leq n \leq 1000$$

Is this still true for $n > 1000$?

Problem 19. For the first values of the $Sdf(n)$ function the following inequality is true:

$$\frac{Sdf(n)}{n} \leq \frac{1}{n^{0.73}} \quad \text{for } 1 \leq n \leq 1000$$

Is this still true for all values of $n > 1000$?

Problem 20. For the first values of the $Sdf(n)$ function the following inequality hold:

$$\frac{1}{n} + \frac{1}{Sdf(n)} < n^{-\frac{1}{4}} \quad \text{for } 2 < n \leq 1000$$

Is this still true for $n > 1000$?

Problem 21. For the first values of the $Sdf(n)$ function the following inequality holds:

$$\frac{1}{n \cdot Sdf(n)} < n^{-\frac{5}{4}} \quad \text{for } 1 \leq n \leq 1000$$

Is this inequality still true for $n > 1000$?

Problem 22. Study the convergence of the Smarandache Double factorial harmonic series:

$$\sum_{n=1}^{\infty} \frac{1}{Sdf^a(n)} \quad \text{where } a > 0 \text{ and } a \in \mathbb{R}$$

Problem 23. Study the convergence of the series:

$$\sum_{n=1}^{\infty} \frac{x_{n+1} - x_n}{Sdf(x_n)}$$

where x_n is any increasing sequence such that $\lim_{n \rightarrow \infty} x_n = \infty$

Problem 24. Evaluate

$$\lim_{n \rightarrow \infty} \frac{\sum_{k=2}^n \frac{\ln(Sdf(k))}{\ln(k)}}{n}$$

Is this limit convergent to some known mathematical constant?

Problem 25. Solve the functional equation:

$$Sdf(n)^r + Sdf(n)^{r-1} + \Lambda \wedge Sdf(n) = n$$

where r is an integer ≥ 2 .

What about the functional equation:

$$Sdf(n)^r + Sdf(n)^{r-1} + \Lambda \wedge Sdf(n) = k \cdot n$$

where r and k are two integers ≥ 2 .

Problem 26. Is there any relationship between $Sdf\left(\prod_{k=1}^m m_k\right)$ and $\sum_{k=1}^m Sdf(m_k)$?

References.

- [1] F. Smarandache, *"Only Problems, not Solutions!"*, Xiquan, Publishing House, Phoenix-Chicago, 1990, 1991, 1993;
- [2] F. Smarandache, *"The Florentin Smarandache papers"* special collection, Arizona State University, Hayden Library, Tempe, Box 871006, AZ 85287-1006, USA;
- [3] C. Dumitrescu and V. Seleacu, *Some notions and questions in Number Theory*, Erhus Univ. Press, Glendale 1994
- [4] E. Weisstein, *CRC Concise Encyclopedia of Mathematics*, CRC Press, 1999
- [5] P. Ribenboim, *The book of prime numbers records*, Second edition, New York, Springer-Verlag, 1989

GEOMETRIA INTERIOARĂ

Adrian VasIU

Angela VasIU

Universitatea Babes-Bolyai
3400 Cluj-Napoca, Romania

TRANSGRESAREA FRONTIERELOR DINTRE DISCIPLINE

În ultimii 30 de ani se răspândește tot mai mult în lume cuvântul transdisciplinaritate. Fiind adesea confundat cu pluridisciplinaritatea și interdisciplinaritatea, se impun câteva precizări.

Cu toții înțelegem nevoia stringentă de a construi *punți* de legătură între diferite discipline, acum când explozia informațională ne duce la adâncirea unor studii disciplinare care face tot mai greoaie comunicarea între specialiști, chiar și din domenii apropiate. Această imperioasă nevoie a condus la apariția pluridisciplinarității și interdisciplinarității, către mijlocul secolului XX.

Pluridisciplinaritatea realizează un același studiu din punctul de vedere al mai multor discipline. *Interdisciplinaritatea* are ca scop transferul metodelor unei discipline, altor discipline. Aceste cercetări au fost impulsionate de tentativele de apropiere dintre artă și știință. Inițiativele multi și inter-disciplinare au avut marele merit de a releva că dialogul dintre știință și artă este posibil și necesar.

Prima Geometrie ne-euclidiană se naște din cea euclidiană: prin *negarea* axiomei unicității paralelei printr-un punct la o dreaptă. Astăzi, clasa Geometriilor ne-euclidiene este mult mai vastă, iar Geometria absolută - ca fundament comun al diferitelor tipuri de Geometrii - este o noțiune care se modifică mereu, e o noțiune în evoluție.

S-a ajuns la negarea tuturor axiomelor lui D. Hilbert, puse la baza Geometriei euclidiene, prin introducerea Anti-Geometriei și Geometriei paradoxiste, de către Florentin Smarandache în [9].

Această paletă largă a tipurilor de Geometrii ne-euclidiene nu ne mai șochează, nu ne surprinde. Ele sunt studiate, iar prin *modele proprii* se dovedesc a fi consistente și ne-contradictorii. Tot așa, a apărut o imensă varietate în paleta: bio-psiho-socială a condiției umane.

Studiul diferitelor clase de Geometrii ne conduce în mod natural la noțiunea de "*Geometrie interioară*" pe care o considerăm ca fiind *starea* la un moment dat a gradului de manifestare sau blocare a însușirilor înnăscute ale omului, ale corpului său subtil. Multiplele combinații și permutări ale calităților înnăscute ale unei ființe; existente în stare *latentă* sau în diferite grade de *adormire* reprezintă o *infinită varietate* pe care în [11] am numit-o "*Geometrie interioară*". Ea poate fi diferită de la un moment la altul și noi, fiecare, știm cât ne poate costa aceasta! Putem numi și altfel Geometria interioară. N-are importanță denumirea pe care diferiți specialiști i-o pot da. Importantă este doar, semnificația denumirii.

De la prima Geometrie ne-euclidiană, care neagă o proprietate a Geometriei euclidiene, putem ajunge la alte tipuri de Geometrii în care

negăm chiar toate axiomele Geometriei euclidiene, ajungând la o Anti-Geometrie sau Geometrie Paradoxistă de tip Smarandache, introdusă în [9].

După gradul de blocare a diferitelor însușiri ale ființei noastre interioare, avem și noi diferite "Geometrii interioare". Prin diferitele tipuri de Geometrii ne-euclidiene putem înțelege marea diversitate bio-psiho-socială, de la angelic și sublim, până la: degradare, depersonalizare sau dezumanizare. Aceasta ne ajută în câteva direcții.

1. Acceptăm alături de noi, chiar cu înțelepciune și bunăvoință și pe cei care gândesc sau se comportă altfel, știind că suntem diferiți - după șansa proprie a stării ființei interioare și exterioare.

2. Propriile probleme sau ale celorlalți le înțelegem *nu ca o pedeapsă* a lui Dumnezeu, ci ca o consecință a propriilor blocaje, a ignoranței sau sfidării Legilor naturale universale și ale cunoașterii de sine. Atunci, în loc să-i judecăm pe alții, sau să-i criticăm, or să ne plângem în vreun fel, știm că e mai bine să-i ajutăm, altfel contribuim la sporirea propriilor perturbări și a negativității din jur. Atunci înțelegem primul principiu din cartea [1]: "nu critica, nu condamna, *nu te plânge*". Altfel, ne creem blocaje subtile.

3. Devenim conștienți de nevoia supravegherii vieții noastre, de nevoia: de clipe de liniște pentru a *deveni noi înșine*, pentru a ne da șansa manifestării plenare a ființei interioare.

Grație eforturilor din multiplele direcții menționate și a multor alora, putem avea încredere că avem șansa redresării acestei lumi bulversate de atâta violență și confuzie. Asistăm la o *renaștere* care ne umple sufletele de un optimism, bine fundamentat, de atâția căutători ai adevărului, din cele mai diferite domenii.

BIBLIOGRAFIE

1. Dale Carnegie, *Secretele succesului. Cum să vă faceți prieteni și să deveniți influent*, Editura Cartea Veche, București, 1989.
2. Dan Costian, *În lumina Bibliei. Biblia și India*, Vol.I, Editura Nemira, București, 1999.
3. V.R. Dhiravamsa, *Calea Non-atașamentului pentru a reuși singur în viață*, Editura Colosseum, București, 1995.
4. Shri Mataji Nirmala Devi, *Meta Modern Era*, Vishwa Nirmala Dharma, Bombay, 1995.
5. Basarab Nicolescu, *Transdisciplinaritatea. Manifest.* Editura Polirom Iași, 1999.
6. Umesh C. Rai, *Medical Science Enlightened*, Ed. Harper, San Francisco, 1990.
7. R. T. Rajasekharan, R. Venkatesan, *Divine Knowledge Through Vibrations*, Panther Publ. Bangalore, 1992.
8. José Antonio Salgado, *Sahaja Yoga*, Editura Ariadna Bacău, 1996.
9. Florentin Smarandache, *Collected Papers*, 1997, Vol.II, University of Kishinev, Press Kishinev.
10. Angela VasIU, Adrian VasIU, *Geometria în sprijinul învățământului formativ*, Dokia Publ. House Ltd., 1998
11. Adrian VasIU, Angela VasIU, *Fundamentele integrării naturale în viață*, Dokia Publishing House Ltd., 1998.
12. Adrian VasIU, Angela VasIU, *Bolyai invites us to more wisdom, to our awakening*, Proceedings of Symp. in Geom., "Babeș-Bolyai" Univ., Nr.2, 1993.
13. Gwenaäl Verez, *La Mere et la Spiritualité*, Publisud, Paris, 1995.
14. Yogi Mahajan, *Geeta Enlightened*, Motilal Banarsidass, Delhi, Yaranasi, Madras, 1989.

On some Smarandache conjectures and unsolved problems

Felice Russo
Via A. Infante 7
67051 Avezzano (Aq) Italy

In this paper some Smarandache conjectures and open questions will be analysed. The first three conjectures are related to prime numbers and formulated by F. Smarandache in [1].

1) First Smarandache conjecture on primes

The equation:

$$B_n(x) = p_{n+1}^x - p_n^x = 1 ,$$

where p_n is the n-th prime, has a unique solution between 0.5 and 1;

- the maximum solution occurs for $n = 1$, i.e.

$$3^x - 2^x = 1 \quad \text{when } x = 1;$$

- the minimum solution occurs for $n = 31$, i.e.

$$127^x - 113^x = 1 \quad \text{when } x = 0.567148K = a_0$$

First of all observe that the function $B_n(x)$ which graph is reported in the fig. 5.1 for some values of n , is an increasing function for $x > 0$ and then it admits a unique solution for $0.5 \leq x \leq 1$.

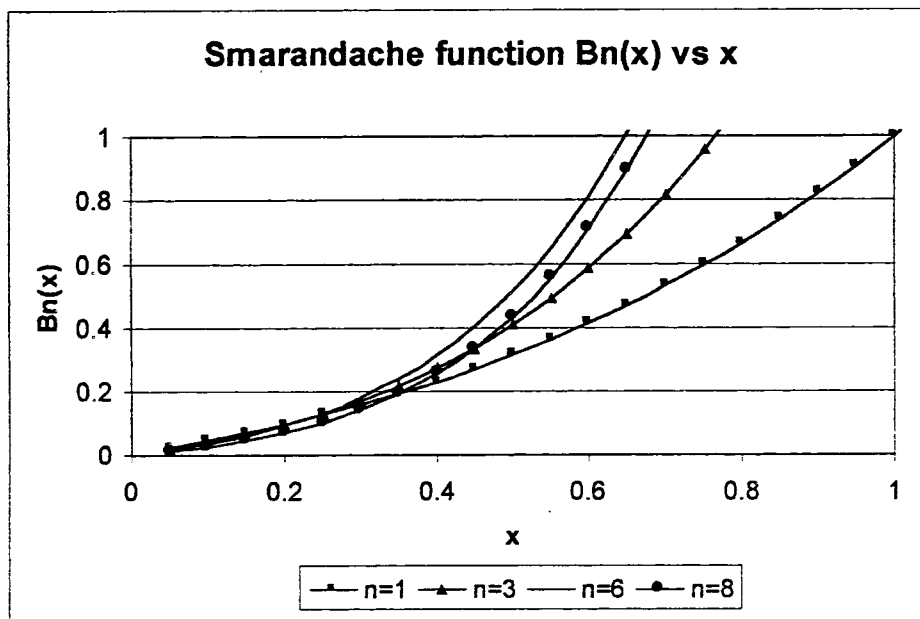

Fig. 5.1

In fact the derivate of $B_n(x)$ function is given by:

$$\frac{d}{dx} B_n(x) = p_{n+1}^x \cdot \ln(p_{n+1}) - p_n^x \cdot \ln(p_n)$$

and then since $p_{n+1} > p_n$ we have:

$$\ln(p_{n+1}) > \ln(p_n) \quad \text{and} \quad p_{n+1}^x > p_n^x \quad \text{for } x > 0$$

This implies that $\frac{d}{dx} B_n(x) > 0$ for $x > 0$ and $n > 0$.

Being the $B_n(x)$ an increasing function, the Smarandache conjecture is equivalent to:

$$B_n^0 = p_{n+1}^{a_0} - p_n^{a_0} \leq 1$$

that is, the intersection of $B_n(x)$ function with $x = a_0$ line is always lower or equal to 1. Then an Ubasic program has been written to test the new version of Smarandache conjecture for all primes lower than 2^{27} . In this range the conjecture is true. Moreover we have created an histogram for the intersection values of $B_n(x)$ with $x = a_0$:

Counts	Interval
7600437	[0, 0.1]
2640]0.1, 0.2]
318]0.2, 0.3]
96]0.3, 0.4]
36]0.4, 0.5]
9]0.5, 0.6]
10]0.6, 0.7]
2]0.7, 0.8]
3]0.8, 0.9]
1]0.9, 1]

This means for example that the function $B_n(x)$ intersects the axis $x = a_0$, 318 times in the interval $]0.2, 0.3]$ for all n such that $p_n < 2^{27}$.

In the fig. 5.2 the graph of normalized histogram is reported (black dots). According to the experimental data an interpolating function has been estimated (continuous curve):

$$B_n^0 = 8 \cdot 10^{-8} \cdot \frac{1}{n^{6.2419}}$$

with a good R^2 value (97%).

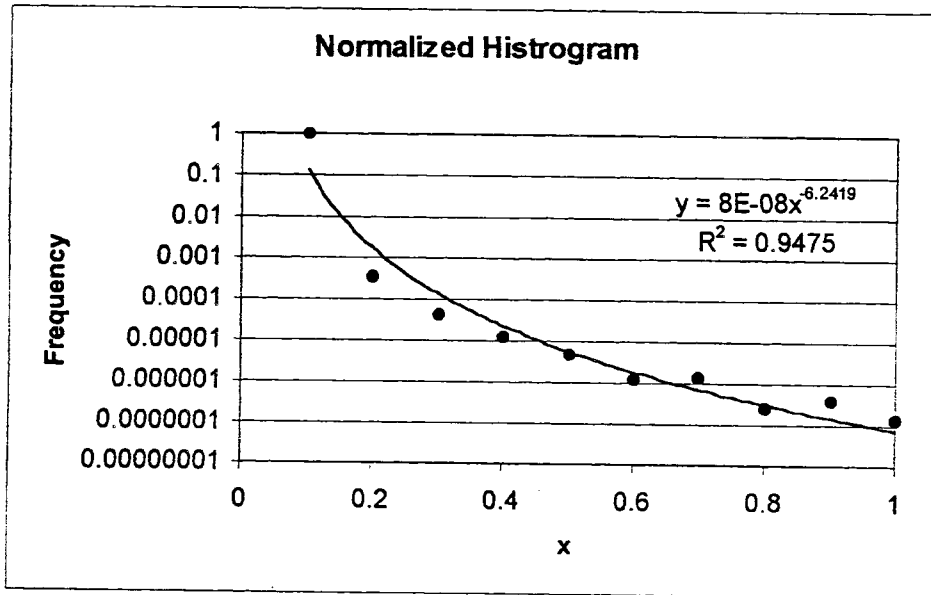

Fig. 5.2

Assuming this function as empirical probability density function we can evaluate the probability that $B_n^0 > 1$ and then that the Smarandache conjecture is false. By definition of probability we have:

$$P(B_n^0 > 1) = \frac{\int_c^\infty B_n^0 dn}{\int_c^\infty B_n^0 dn} \approx 6.99 \cdot 10^{-19}$$

where $c=3.44E-4$ is the lower limit of B_n^0 found with our computer search. Based on those experimental data there is a strong evidence that the Smarandache conjecture on primes is true.

2) Second Smarandache conjecture on primes.

$$B_n(x) = p_{n+1}^x - p_n^x < 1$$

where $x < a_0$. Here p_n is the n -th prime number.

This conjecture is a direct consequence of conjecture number 1 analysed before. In fact being $B_n(x)$ an increasing function if:

$$B_n^0 = p_{n+1}^{a_0} - p_n^{a_0} \leq 1$$

is verified then for $x < a_0$ we have no intersections of the $B_n(x)$ function with the line $B_n(x) = 1$, and then $B_n(x)$ is always lower than 1.

3) Third Smarandache conjecture on primes.

$$C_n(k) = p_{n+1}^{\frac{1}{k}} - p_n^{\frac{1}{k}} < \frac{2}{k} \quad \text{for } k \geq 2 \text{ and } p_n \text{ the } n\text{-th prime number}$$

This conjecture has been verified for prime numbers up to 2^{25} and $2 \leq k \leq 10$ by the author [2]. Moreover a heuristic that highlight the validity of conjecture out of range analysed was given too.

At the end of the paper the author reformulated the Smarandache conjecture in the following one:

Smarandache-Russo conjecture

$$C_n(k) \leq \frac{2}{k^{2 \cdot a_0}} \quad \text{for } k \geq 2$$

where a_0 is the Smarandache constant $a_0 = 0.567148...$ (see [1]).

So in this case for example the Andrica conjecture (namely the Smarandache conjecture for $k=2$) becomes:

$$\sqrt{p_{n+1}} - \sqrt{p_n} < 0.911111\dots$$

Thanks to a program written with Ubasic software the conjecture has been verified to be true for all primes $p_n < 2^{25}$ and $2 \leq k \leq 15$.

In the following table the results of the computer search are reported.

k	2	3	4	5	6	7	8	9	10	11	12	13	14	15
Max_C(n,k)	0.6708	0.3110	0.1945	0.1396	0.1082	0.0885	0.0756	0.0659	0.0584	0.0525	0.0476	0.0436	0.0401	0.0372
$2/k^{2a_0}$	0.4150	0.1654	0.0861	0.0519	0.0343	0.0242	0.0178	0.0136	0.0107	0.0086	0.0071	0.0060	0.0050	0.0043
delta	0.2402	0.2641	0.2204	0.1826	0.1538	0.1314	0.1134	0.0994	0.0883	0.0792	0.0717	0.0654	0.0600	0.0554

Max_C(n,k) is the largest value of the Smarandache function $C_n(k)$ for $2 \leq k \leq 15$

and $p_n < 2^{25}$ and delta is the difference between $\frac{2}{k^{2a_0}}$ and Max_C(n,k).

Let's now analyse the behaviour of the delta function versus the k parameter. As highlighted in the following graph (fig. 5.3),

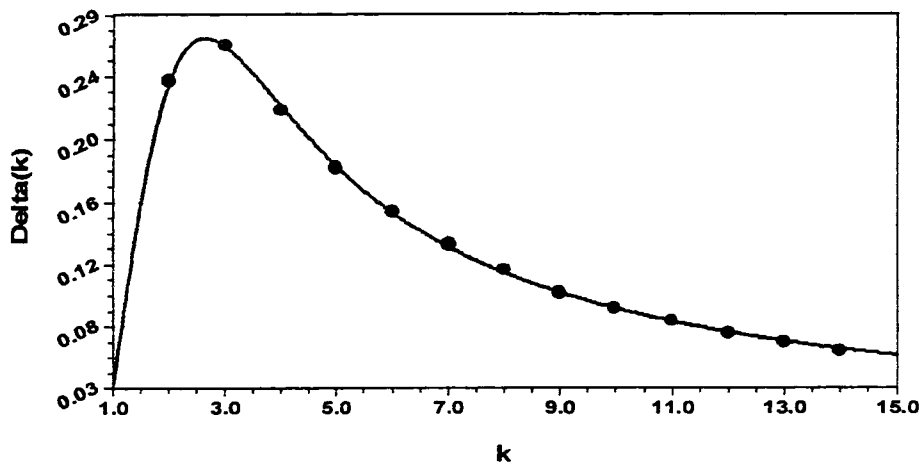

Fig. 5.3

an interpolating function with good R^2 (0.999) has been estimated:

$$\Delta(k) = \frac{a + b \cdot k}{1 + c \cdot k + d \cdot k^2}$$

where: $a = 0.1525\dots$, $b = 0.17771\dots$, $c = -0.5344\dots$, $d = 0.2271\dots$

Since the Smarandache function decrease asymptotically as n increases it is likely that the estimated maximum is valid also for $p_n > 2^{25}$. If this is the case then the interpolating function found reinforce the Smarandache-Russo conjecture being:

$$\Delta(k) \rightarrow 0 \text{ for } k \rightarrow \infty$$

Let's now analyse some Smarandache conjectures that are a generalization of Goldbach conjecture.

4) Smarandache generalization of Goldbach conjectures

C. Goldbach (1690-1764) was a German mathematician who became professor of mathematics in 1725 in St. Petersburg, Russia. In a letter to Euler on June 7, 1742, He speculated that every even number is the sum of three primes.

Goldbach in his letter was assuming that 1 was a prime number. Since we now exclude it as a prime, the modern statements of Goldbach's conjectures are [5]:

Every even number equal or greater than 4 can be expressed as the sum of two primes, and every odd number equal or greater than 9 can be expressed as the sum of three primes.

The first part of this claim is called the Strong Goldbach Conjecture, and the second part is the Weak Goldbach Conjecture.

After all these years, the strong Goldbach conjecture is still not proven, even though virtually all mathematicians believe it is true.

Goldbach's weak conjecture has been proven, almost!

In 1937, I.M. Vonogradov proved that there exist some number N such that all odd numbers that are larger than N can be written as the sum of three primes. This reduce the problem to finding this number N , and then testing all odd numbers up to N to verify that they, too, can be written as the sum of three primes.

How big is N? One of the first estimates of its size was approximately [6]:

$$10^{6846168}$$

But this is a rather large number; to test all odd numbers up to this limit would take more time and computer power than we have. Recent work has improved the estimate of N. In 1989 J.R. Chen and T. Wang computed N to be approximately [7]:

$$10^{43000}$$

This new value for N is much smaller than the previous one, and suggests that some day soon we will be able to test all odd numbers up to this limit to see if they can be written as the sum of three primes.

Anyway assuming the truth of the generalized Riemann hypothesis [5], the number N has been reduced to 10^{20} by Zinoviev [9], Saouter [10] and Deshouillers. Effinger, te Riele and Zinoviev[11] have now successfully reduced N to 5.

Therefore the weak Goldbach conjecture is true, subject to the truth of the generalized Riemann hypothesis.

Let's now analyse the generalizations of Goldbach conjectures reported in [3] and [4]; six different conjectures for odd numbers and four conjectures for even numbers have been formulated. We will consider only the conjectures 1, 4 and 5 for the odd numbers and the conjectures 1, 2 and 3 for the even ones.

4.1 First Smarandache Goldbach conjecture on even numbers.

Every even integer n can be written as the difference of two odd primes, that is $n = p - q$ with p and q two primes.

This conjecture is equivalent to:

For each even integer n , we can find a prime q such that the sum of n and q is itself a prime p .

A program in Ubasic language to check this conjecture has been written.

The result of this check has been that the first Smarandache Goldbach conjecture is true for all even integers equal or smaller than 2^{29} .
The list of Ubasic program follows.

```

1 ' *****
2 '           Smarandache Goldbach conjecture
3 '           on even numbers: n=p-q with p and q two primes
4 '           by Felice Russo Oct. 1999
5 ' *****
10 cls
20 for N=2 to 2^28 step 2
22 W=3
25 locate 10,10:print N
30 for Q=W to 10^9
40 gosub *Pspr(Q)
50 if Pass=0 then goto 70
60 cancel for:goto 80
70 next
75 print N,"The Smarandache conjecture is not true up to 10^9 for q=";Q
80 Sum=N+Q
90 gosub *Pspr(Sum)
100 if Pass=1 then goto 120
110 W=Q+1:goto 30
120 next
130 print "The Smarandache conjecture has been verified up to:";N-2
140 end
1000 ' *****
1010 '           Strong Pseudoprime Test Subroutine
1020 '           by Felice Russo 25/5/99
1030 ' *****
1040 '
1050 ' The sub return the value of variable PASS.
1060 ' If pass is equal to 1 then N is a prime.
1070 '
1080 '
1090 *Pspr(N)
1100 local I,J,W,T,A,Test

```

```

1110 W=3:if N=2 then Pass=1:goto 1290
1120 if even(N)=1 or N=1 then Pass=0:goto 1290
1130 if prmdiv(N)=N then Pass=1:goto 1290
1140 if prmdiv(N)>0 and prmdiv(N)<N then Pass=0:goto 1290
1150 I=W
1160 if gcd(I,N)=1 then goto 1180
1170 W=I+1:goto 1150
1180 T=N-1:A=A+1
1190 while even(T)=1
1200 T=T\2:A=A+1
1210 wend
1220 Test=modpow(I,T,N)
1230 if Test=1 or Test=N-1 then Pass=1:goto 1290
1240 for J=1 to A-1
1250 Test=(Test*Test)@N
1260 if Test=N-1 then Pass=1:cancel for:goto 1290
1270 next
1280 Pass=0
1290 return

```

For each even integer n the program check if it is possible to find a prime q , generated by a subroutine (rows from 1000 to 1290) that tests the primality of an integer, such that the sum of n and q , $\text{sum}=n+q$ (see rows 80 and 90) is again a prime.

If yes the program jumps to the next even integer. Of course we have checked only a little quantity of integers out of infinite number of them.

Anyway we can get some further information from experimental data about the validity of this conjecture.

In fact we can calculate the ratio q/n for the first 3000 values, for example, and then graphs this ratio versus n (see fig. 5.4).

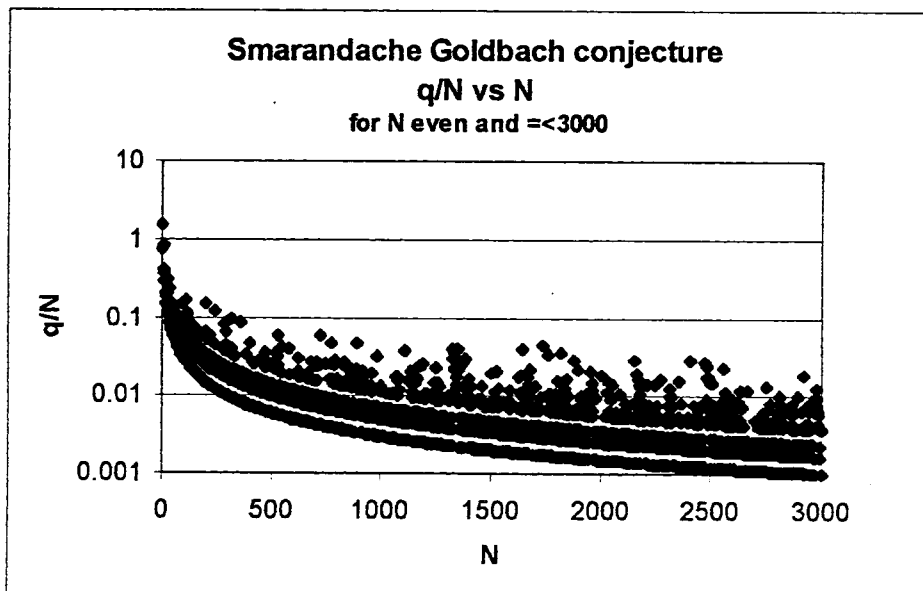

Fig. 5.4

As we can see this ratio is a decreasing function of n ; this means that for each n is very easy to find a prime q such that $n+q$ is a prime. This heuristic well support the Smarandache-Goldbach conjecture.

4.2 Second Smarandache-Goldbach conjecture on even numbers.

Every even integer n can be expressed as a combination of four primes as follows:

$$n=p+q+r-t \text{ where } p, q, r, t \text{ are primes.}$$

For example: $2=3+3+3-7$, $4=3+3+5-7$, $6=3+5+5-7$, $8=11+5+5-13$

Regarding this conjecture we can notice that since n is even and t is an odd prime their sum is an odd integer.

So the conjecture is equivalent to the weak Goldbach conjecture because we can always choose a prime t such that $n+t \geq 9$.

4.3 Third Smarandache-Goldbach conjecture on even numbers.

Every even integer n can be expressed as a combination of four primes as follows:

$$n=p+q-r-t \text{ where } p, q, r, t \text{ are primes.}$$

For example: $2=11+11-3-17$, $4=11+13-3-17$, $6=13+13-3-17$, $8=11+17-7-13$

As before this conjecture is equivalent to the strong Goldbach conjecture because the sum of an even integer plus two odd primes is an even integer. But according to the Goldbach conjecture every even integer ≥ 4 can be expressed as the sum of two primes.

4.4 First Smarandache Goldbach conjecture on odd numbers.

Every odd integer n , can be written as the sum of two primes minus another prime:

$$n=p+q-r \text{ where } p, q, r \text{ are prime numbers.}$$

For example: $1=3+5-7$, $3=5+5-7$, $5=3+13-11$, $7=11+13-17$ $9=5+7-3$

Since the sum of an odd integer plus an odd prime is an even integer this conjecture is equivalent to the strong Goldbach conjecture that states that every even integer ≥ 4 can be written as the sum of two prime numbers.

A little variant of this conjecture can be formulated requiring that all the three primes must be different.

For this purpose an Ubasic program has been written. The conjecture has been verified to be true for odd integers up to 2^{29} .

The algorithm is very simple. In fact for each odd integer n , we put $r=3$, $p=3$ and q equal to the largest primes smaller than $n+r$.

Then we check the sum of p and q . If it is greater than $n+r$ then we decrease the variable q to the largest prime smaller than the previous one. On the contrary if the sum is smaller than $n+r$ we increase the variable p to the next prime. This loop continues until p is lower than q . If this is not the case then we increase the variable r to the next prime and we restart again the check on p and q . If the sum of n and r

coincide with that of p and q the last check is on the three primes r, p and q that must be of course different. If this is not the case then we reject this solution and start again the check.

```

1 ' *****
2 '      First Smarandache-Goldbach conjecture
3 '              on odd integers
4 '              by Felice Russo Oct. 99
5 ' *****
10 cls:Lim=2^29
20 for N=1 to Lim step 2
30 S=3:W=3
40 locate 10,10:print N
50 r=S
60 gosub *Pspr(r)
70 if Pass=0 then goto 260
80 Sum1=N+r:L=0:H=Sum1-1
90 p=W
100 gosub *Pspr(p)
110 if Pass=1 and L=0 then goto 140
120 if Pass=1 and L=1 then goto 190
130 W=p+1:goto 90
140 q=H
150 gosub *Pspr(q)
160 if Pass=1 then goto 190
170 H=q-1:goto 140
190 Sum2=p+q
200 if p>=q then goto 260
210 if Sum2>Sum1 then H=q-1:goto 140
220 if Sum2<Sum1 then W=p+1:L=1:goto 90
230 if r=p or r=q and p<q then W=p+1:goto 90
240 if r=p or r=q and p>=q then goto 260
250 goto 270
260 S=r+1:if r>2^25 goto 290 else goto 50
270 next
280 cls:print "Conjecture verified up to";Lim:goto 300
290 cls:print "Conjecture not verified up to 2^25 for";N

```



```

300 end
310 ' *****
320 '      Strong Pseudoprime Test Subroutine
330 '      by Felice Russo 25/5/99
340 ' *****
350 '
360 ' The sub return the value of variable PASS.
370 ' If pass is equal to 1 then N is a prime.
380 '
390 '
400 *Pspr(N)
410 local I,J,W,T,A,Test
420 W=3:if N=2 then Pass=1:goto 600
430 if even(N)=1 or N=1 then Pass=0:goto 600
440 if prmdiv(N)=N then Pass=1:goto 600
450 if prmdiv(N)>0 and prmdiv(N)<N then Pass=0:goto 600
460 I=W
470 if gcd(I,N)=1 then goto 490
480 W=I+1:goto 460
490 T=N-1:A=A+1
500 while even(T)=1
510 T=T\2:A=A+1
520 wend
530 Test=modpow(I,T,N)
540 if Test=1 or Test=N-1 then Pass=1:goto 600
550 for J=1 to A-1
560 Test=(Test*Test)@N
570 if Test=N-1 then Pass=1:cancel for:goto 600
580 next
590 Pass=0
600 return

```

4.5 Fourth Smarandache Goldbach conjecture on odd numbers.

Every odd integer n can be expressed as a combination of five primes as follows:

$$n=p+q+r-t-u \text{ where } p, q, r, t, u \text{ are all prime numbers.}$$

For example: $1=3+7+17-13-13$, $3=5+7+17-13-13$, $5=7+7+17-13-13$,
 $7=5+11+17-13-13$

Also in this case the conjecture is equivalent to the weak Goldbach conjecture. In fact the sum of two odd primes plus an odd integer is always an odd integer and according to the weak Goldbach conjecture it can be expressed as the sum of three primes.

Now we will analyse a conjecture about the wrong numbers introduced in Number Theory by F. Smarandache and reported for instance in [8] and then we will analyse a problem proposed by Castillo in [12].

5) Smarandache Wrong numbers

A number $n = \overline{a_1 a_2 a_3 \dots a_k}$ of at least two digits, is said a Smarandache Wrong number if the sequence:

$$a_1, a_2, a_3, K K, a_k, b_{k+1}, b_{k+2}, K K$$

(where b_{k+i} is the product of the previous k terms, for any $i \geq 0$) contains n as its term [8].

Smarandache conjectured that there are no Smarandache Wrong numbers.

In order to check the validity of this conjecture up to some value N_0 , an Ubasic program has been written.

N_0 has been choose equal to 2^{28} . For all integers $n \leq N_0$ the conjecture has been proven to be true. Moreover utilizing the experimental data obtained with the computer program a heuristic that reinforce the validity of conjecture can be given. First of all let's define what we will call the Smarandache Wrongness of an integer n with at least two digits. For any integer n , by definition of Smarandache Wrong number we must create the sequence:

$$a_1, a_2, a_3, K K, a_k, b_{k+1}, b_{k+2}, K K$$

as reported above. Of course this sequence is stopped once a term b_{k+i} equal or greater than n is obtained.

Then for each integer n we can define two distance:

$$d_1 = |b_{k+i} - n| \quad \text{and} \quad d_2 = |b_{k+i-1} - n|$$

The Smarandache Wrongness of n is defined as $\min\{d_1, d_2\}$ that is the minimum value between d_1 and d_2 and indicate with $W(n)$. Based on definition of $W(n)$, if the Smarandache conjecture is false then for some n we should have $W(n)=0$.

Of course by definition of wrong number, $W(n)=n$ if n contains any digit equal to zero and $W(n)=n-1$ if n is repunit (that is all the digits are 1). In the following analysis we will exclude this two species of integers. With the Ubasic program utilized to test the smarandache conjecture we have calculated the $W(n)$ function for $12 \leq n \leq 3000$. The graph of $W(n)$ versus n follows.

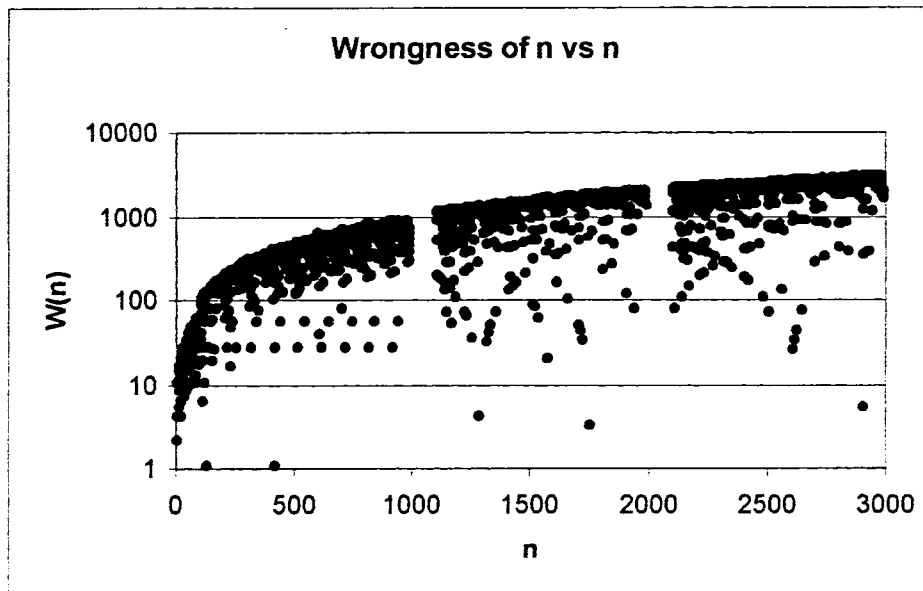

Fig. 5.5

as reported above. Of course this sequence is stopped once a term b_{k+i} equal or greater than n is obtained.

Then for each integer n we can define two distance:

$$d_1 = |b_{k+i} - n| \quad \text{and} \quad d_2 = |b_{k+i-1} - n|$$

The Smarandache Wrongness of n is defined as $\min\{d_1, d_2\}$ that is the minimum value between d_1 and d_2 and indicate with $W(n)$. Based on definition of $W(n)$, if the Smarandache conjecture is false then for some n we should have $W(n)=0$.

Of course by definition of wrong number, $W(n)=n$ if n contains any digit equal to zero and $W(n)=n-1$ if n is repunit (that is all the digits are 1). In the following analysis we will exclude this two species of integers. With the Ubasic program utilized to test the smarandache conjecture we have calculated the $W(n)$ function for $12 \leq n \leq 3000$. The graph of $W(n)$ versus n follows.

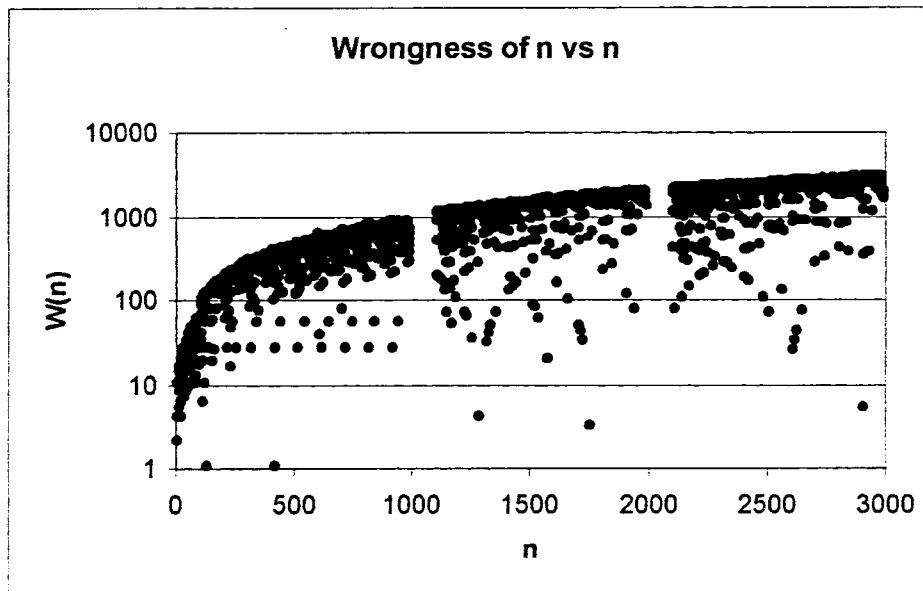

Fig. 5.5

As we can see $W(n)$ in average increases linearly with n even though at a more close view (see fig. 5.6) a nice triangular pattern emerges with points scattered in the region between the x-axis and the triangles.

Anyway the average behaviour of $W(n)$ function seems to support the validity of Smarandache conjecture.

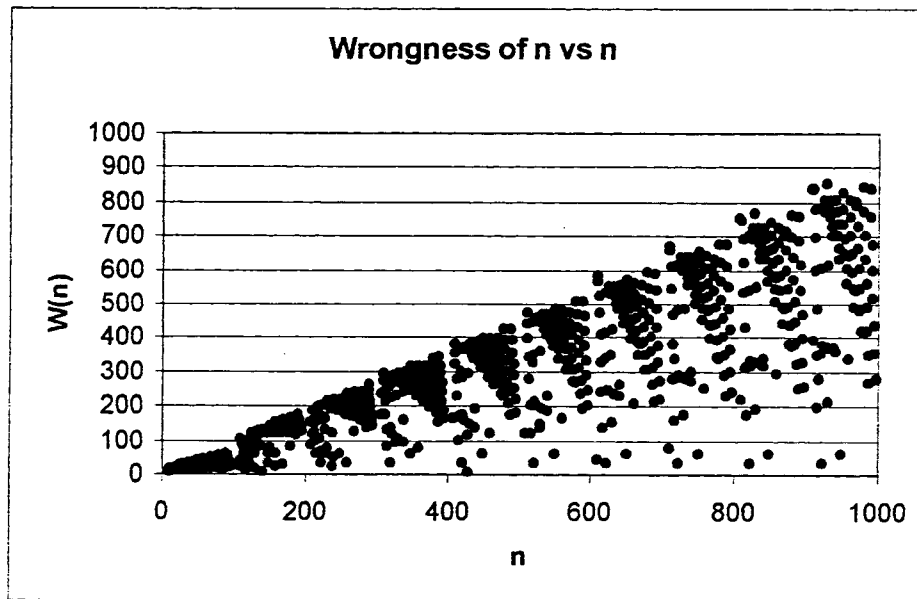

Fig. 5.6

Let's now divide the integers n into two families: those for which the $W(n)$ function is smaller than 5 and those for which it is greater than 5.

The integers with $W(n)$ smaller than 5 will be called the Smarandache Weak Wrong numbers.

Up to 2^{28} the sequence of weak wrong numbers is given by the following integers n :

n	W(n)	interv.	C_Ww(n)
12	4	10^2	5
13	4	10^3	2
14	2	10^4	4
23	5	10^5	2
31	4	10^6	1
143	1	10^7	1
431	1	10^8	0
1292	4	2^{28}	0
1761	3	2^{29}	0
2911	5		
6148	4		
11663	1		
23326	2		
314933	5		
5242881	1		

Here $W(n)$ is the Wrongness of n and $C_Ww(n)$ is the number of the weak wrong numbers between 10 and 10^2 , 10^2 and 10^3 and so on.

Once again the experimental data well support the Smarandache conjecture because the density of the weak wrong numbers seems goes rapidly to zero.

6) About a problem on continued fraction of Smarandache consecutive and reverse sequences.

In [12] J. Castillo introduced the notion of Smarandache simple continued fraction and Smarandache general continued fraction. As example he considered the application of this new concept to the two well-know Smarandache sequences:

Smarandache consecutive sequence

1, 12, 123, 1234, 12345, 123456, 1234567

Smarandache reverse sequence

1, 21, 321, 4321, 54321, 654321, 7654321

At the end of its article the following problem has been formulated:

Is the simple continued fraction of consecutive sequence convergent? If yes calculate the limit.

$$1 + \frac{1}{12 + \frac{1}{123 + \frac{1}{1234 + \frac{1}{12345 + \Lambda}}}}$$

Is the general continued fraction of consecutive and reverse sequences convergent? If yes calculate the limit.

$$1 + \frac{1}{12 + \frac{21}{123 + \frac{321}{1234 + \frac{4321}{12345 + \Lambda}}}}$$

Using the Ubasic software a program to calculate numerically the above continued fractions has been written. Here below the result of computation.

$$1 + \frac{1}{12 + \frac{1}{123 + \frac{1}{1234 + \frac{1}{12345 + \Lambda}}}} \approx 1.0833\dots$$

$$1 + \frac{1}{12 + \frac{1}{123 + \frac{1}{1234 + \frac{1}{12345 + \dots}}}} \approx 1.0822\dots \approx K_e$$

where K_e is the Keane's constant (see [13])

Moreover for both the sequences the continued radical (see chapter II) and the Smarandache series [14] have been evaluated too.

$$\sqrt{1 + \sqrt{12 + \sqrt{123 + \sqrt{1234 + \dots}}}} \approx 2.442\dots \approx \frac{2}{7} \cdot \sin\left(\frac{\pi}{18}\right)$$

$$\sqrt{1 + \sqrt{21 + \sqrt{321 + \sqrt{4321 + \dots}}}} \approx 2.716\dots \approx \lim_{x \rightarrow \infty} (1+x)^{\frac{1}{x}} = e$$

$$\sum_{n=1}^{\infty} \frac{1}{a(n)} \approx 1.0924\dots \approx B$$

where $a(n)$ is the Smarandache consecutive sequence and B the Brun's constant [15].

$$\sum_{n=1}^{\infty} \frac{1}{b(n)} \approx 1.051\dots$$

where $b(n)$ is the Smarandache reverse sequence.

References

- [1] Smarandache, Florentin, "*Conjectures which Generalize Andrica's Conjecture*", Arizona State University, Hayden Library, Special Collections, Tempe, AZ, USA.
- [2] <http://www.gallup.unm.edu/~smarandache/russo3.htm>
- [3] M. Bencze, *Bulletin of Pure and Applied Sciences*. Vol. 17 E(No. 1) 1998; p. 55-62
- [4] <http://www.gallup.unm.edu/~smarandache/prim-sum.txt>
- [5] E. Weisstein, *CRC Concise Encyclopedia of Mathematics*, CRC Press, 1999
- [6] P. Ribenboim, *The book of prime numbers records*, Second edition, New York, Springer-Verlag, 1989
- [7] Internet: sci.math, Boklan, July 21, 1994
- [8] C. Dumitrescu and V. Seleacu, *Some notions and questions in Number Theory*, Erhus Univ. Press, Glendale 1994
- [9] D. Zinoviev, *On Vinogradov's constant in Goldbach's ternary problem*, J. Number Theory 65 (1997) 334-358.
- [10] Y. Saouter, *Checking the odd Goldbach conjecture up to 10^{20}* , Math. Comp. 67 (1998) 863-866.
- [11] J.-M. Deshouillers, G. Effinger; H. te Riele and D. Zinoviev, *A complete Vinogradov 3-primes theorem under the Riemann hypothesis*, Elec. Research Announc. Amer. Math. Soc. 3 (1997), 99-104.
- [12] J. Castillo, *Smarandache continued fractions*, Bulletin of pure and applied Sciences, Vol. 17E, No.1, 1998, p. 149-151
- [13] S. Finch in <http://www.mathsoft.com/asolve/constant/geom/geom.html>
- [14] <http://www.gallup.unm.edu/~smarandache/SERIES.TXT>
- [15] S. Finch in <http://www.mathsoft.com/asolve/constant/brun/brun.html>

A recurrence formula for prime numbers using the Smarandache or Totient functions

Felice Russo

Via A. Infante 67051

Avezzano (Aq) Italy

felice.russo@katamail.com

Abstract

In this paper we report a recurrence formula to obtain the n-th prime in terms of (n-1)th prime and as a function of Smarandache or Totient function.

In [1] the Smarandache Prime Function is defined as follows:

$$P: N \rightarrow (0,1)$$

$$\text{where: } P(n) = \begin{cases} 0 & \text{if } n \text{ is prime} \\ 1 & \text{if } n \text{ is composite} \end{cases}$$

This function can be used to determine the number of primes $\pi(N)$ less or equal to some integer N and to determine a recurrence formula to obtain the n-th prime starting from the (n-1)th one.

In fact:

$$\pi(N) = \sum_{i=1}^N (1 - P(i))$$

and

$$p_{n+1} = 1 + p_n + \sum_{j=p_n+1}^{2p_n} \prod_{i=p_n+1}^j P(i)$$

where p_n is the n-th prime.

The first equation is obvious because $(1 - P(i))$ is equal to 1 every time i is a prime. Let's prove the second one.

Since $p_{n+1} < 2p_n$ [2] where p_{n+1} and p_n are the $(n+1)$ th and n -th prime respectively, the following equality holds [3]:

$$\sum_{j=p_n+1}^{2p_n} \prod_{i=p_n+1}^j P(i) = \sum_{j=p_n+1}^{p_{n+1}-1} \prod_{i=p_n+1}^j P(i) + \sum_{j=p_n+1}^{2p_n} \prod_{i=p_n+1}^j P(i) = \sum_{j=p_n+1}^{p_{n+1}-1} \prod_{i=p_n+1}^j P(i)$$

because $\sum_{j=p_{n+1}}^{2p_n} \prod_{i=p_n+1}^j P(i) = 0$ being $P(p_{n+1}) = 0$ by definition.

As:

$$\sum_{j=p_n+1}^{p_{n+1}-1} \prod_{i=p_n+1}^j P(i) = \sum_{j=p_n+1}^{p_{n+1}-1} 1 = (p_{n+1} - 1) - (p_n + 1) + 1 = p_{n+1} - p_n - 1$$

we get:

$$p_{n+1} = 1 + p_n + \sum_{j=p_n+1}^{2p_n} \prod_{i=p_n+1}^j P(i) \quad \text{q.e.d}$$

According to this result we can obtain p_{n+1} once we know p_n and $P(i)$.

We report now two expressions for $P(i)$ using the Smarandache function $S(n)$ [4] and the well known Totient function $\varphi(n)$ [5].

- $P(i) = 1 - \left\lfloor \frac{S(i)}{i} \right\rfloor$ for $i > 4$
- $P(i) = 1 - \left\lfloor \frac{\varphi(i)}{i-1} \right\rfloor$ for $i > 1$

where $\lfloor n \rfloor$ is the floor function [6]. Let's prove now the first equality.

By definition of Smarandache function $S(i) = i$ for $i \in P \cup \{1, 4\}$ where P is the set of prime numbers [6]. Then $\left\lfloor \frac{S(i)}{i} \right\rfloor$ is equal to 1 if i is a prime number and equal to zero for all composite > 4 being $S(i) \leq i$ [4].

About the second equality we can notice that by definition $\varphi(n) < n$ for $n > 1$ and $\varphi(n) = n-1$ if and only if n is a prime number [5]. So $\varphi(n) \leq n-1$ for $n > 1$ and this implies that $\left\lfloor \frac{\varphi(i)}{i-1} \right\rfloor$ is equal to 1 if i is a prime number and equal to zero otherwise..

Then:

$$p_{n+1} = 1 + p_n + \sum_{j=p_n+1}^{2p_n} \prod_{i=p_n+1}^j \left(1 - \left\lfloor \frac{S(i)}{i} \right\rfloor \right) \quad \text{for } n > 2$$

and

$$p_{n+1} = 1 + p_n + \sum_{j=p_n+1}^{2p_n} \prod_{i=p_n+1}^j \left(1 - \left\lfloor \frac{\varphi(i)}{i-1} \right\rfloor \right) \quad \text{for } n \geq 1$$

According to the result obtained in [7] for the Smarandache function:

$$S(i) = i + 1 - \left[\sum_{k=1}^i i^{-\left(i \cdot \sin\left(k! \frac{\pi}{i}\right)\right)^2} \right]$$

and in [3] for the following function:

$$\left[\frac{i}{k} \right] - \left[\frac{i-1}{k} \right] = \begin{cases} 1 & \text{if } k \text{ divide } i \\ 0 & \text{if } k \text{ doesn't divide } i \end{cases}$$

the previous recurrence formulas can be further simplified as follows:

$$p_{n+1} = 1 + p_n + \sum_{j=p_n+1}^{2p_n} \prod_{i=p_n+1}^j \left(1 - \frac{\left(i + 1 - \left[\sum_{k=1}^i i^{-\left(i \cdot \sin\left(k! \frac{\pi}{i}\right)\right)^2} \right] \right)}{i} \right) \quad \text{for } n > 2$$

and

$$p_{n+1} = 1 + p_n + \sum_{j=p_n+1}^{2p_n} \prod_{i=p_n+1}^j \left(1 - \frac{\sum_{k=1}^i \left(1 - \left(\left[\frac{i}{k} \right] - \left[\frac{i-1}{k} \right] \right) \right)}{i-1} \right) \quad \text{for } n \geq 1$$

References.

- [1] <http://www.gallup.unm.edu/~smarandache/primfct.txt>
- [2] P. Ribenboim, *The book of prime numbers records*, Second edition, New York, Springer-Verlag, 1989
- [3] S. M. Ruiz, *A functional recurrence to obtain the prime numbers using the Smarandache prime function*, SNJ Vol. 11 N. 1-2-3, Spring 2000
- [4] C. Ashbacher, *An introduction to the Smarandache function*, Erhus Univ. Press, 1995.
- [5] E. Weisstein, *CRC Concise Encyclopedia of Mathematics*, CRC Press, 1999
- [6] E. Burton, *S-primality degree of a number and S-prime numbers*, SNJ Vol. 11 N. 1-2-3, Spring 2000
- [7] M. Le, *A formula of the Smarandache Function*, SNJ Vol. 10 1999

On two problems concerning two Smarandache P-partial digital subsequences

Felice Russo

*Via A. Infante 67051
Avezzano (Aq) Italy
felice.russo@katamail.com*

Abstract

In this paper the solution of two problems posed in [1] and concerning the Smarandache Lucas-partial subsequence and the Smarandache Fibonacci-partial subsequence is reported.

Introduction

In [1] the Smarandache P-digital subsequence is defined as the sequence obtained screening a starting sequence $\{a_n\}$, $n \geq 1$ defined by a property P, selecting only the terms whose digits satisfy the property P.

In the same way, The Smarandache P-partial digital subsequence is the sequence obtained screening a given sequence $\{a_n\}$, $n \geq 1$ defined by a property P, selecting only the terms whose groups of digits satisfy the property P.

Two examples of Smarandache P-partial subsequence reported in [1] are:

1. The Smarandache Lucas-partial digital subsequence
2. The Smarandache Fibonacci-partial digital subsequence

Results

1. Smarandache Lucas-partial digital subsequence

The Smarandache Lucas-partial digital subsequence is the sequence of Lucas numbers [2] whose sum of the first two groups of digits is equal to the last group of digits.

For example 123 is a Lucas number that can be partitioned as 1, 2 and 3 where $1+2=3$.

In [1] M. Bencze formulated the following problem:

Is 123 the only Lucas number that verifies a Smarandache type partition?

In order to analyse this problem a computer program with Ubasic software package has been written.

We have checked the first 3000 terms of Lucas sequence finding one more number beside 123 that verifies a Smarandache type partition, i.e. the number 20633239 that can be partitioned as 206, 33, 239 where $206+33=239$.

2. *Smarandache Fibonacci-partial digital subsequence*

The Smarandache Fibonacci-partial digital subsequence is the sequence of the Fibonacci numbers [2] whose sum of the first two groups of digits is equal to the last group of digits.

Always in [1] the following problem has been posed:

No Fibonacci number verifying a Smarandache type partition has been found for the first terms of the Fibonacci sequence. Can you investigate larger Fibonacci numbers and determine if someone belongs to the Smarandache Fibonacci-partial digital subsequence?

Modifying slightly the computer program written for the problem on Lucas numbers we have found, among the first 3000 terms of the Fibonacci sequence, a number that verify a Smarandache type partition : 832040 that can be partitioned as 8, 32, 040 where $8+32=40$.

New questions

According to the previous results the following two conjectures can be formulated:

- The Smarandache Lucas-partial digital subsequence is upper limited

Unsolved question: find that upper limit

- The Smarandache Fibonacci-partial digital subsequence is upper limited

Unsolved question: find that upper limit

References:

- [1] M. Bencze, *Smarandache relationships and subsequences*, SNJ Vol. 11 N. 1-2-3, Spring 2000
- [2] E. Weisstein, *CRC Concise Encyclopedia of Mathematics*, CRC Press, 1999

Open Questions For The Smarandache Function

Mihaly Bencze
Brasov, Romania

Let $S(n)$ be the Smarandache function. I propose the following open questions:

1) Solve the following equation in integers:

$$1/S^2(a) = 1/S^2(b) + 1/S^2(c).$$

2) Solve the following equation in integers:

$$S^2(\phi(a)) = S^2(\phi(b)) + S^2(\phi(c)).$$

3) Solve the following equation in integers:

$$S(d(n) + \sigma(n)) = d(S(n)) + \sigma(S(n)).$$

4) Solve the following equation in integers:

$$S(a*d(n) + b*\sigma(n) + c*\phi(n) + d*\psi(n)) = a*d(S(n)) + b*\sigma(S(n)) + c*\phi(S(n)) + d*\psi(S(n)).$$

5) Solve the following equation in integers:

$$S\left(\sum_{k=1}^n n^k\right) = \prod_{k=1}^n S(k)*\phi(n)$$

6) Solve the following equation in integers:

$$\pm S(1) \pm S(2) \pm \dots \pm S(n) = \phi((n(n+1))/2).$$

7) Solve the following equation in integers:

$$S(\pm 1^2 \pm 2^2 \pm \dots \pm n^2) = \pm S^2(1) \pm S^2(2) \pm \dots \pm S^2(n).$$

8) Solve the following equation in integers:

$$S(\pm \mu(1) \pm \mu(2) \pm \dots \pm \mu(n)) = S(\mu((n(n+1))/2)).$$

9) Solve the following equation in integers:

$$S(\pm d(1) \pm d(2) \pm \dots \pm d(n)) = S(d((n(n+1))/2)).$$

10) Solve the following equation in integers:

$$S(\pm \sigma(1) \pm \sigma(2) \pm \dots \pm \sigma(n)) = S(\sigma((n(n+1))/2)).$$

11) Solve the following equation in integers:

$$\frac{1}{S(1)} + \frac{1}{S(2)} + \dots + \frac{1}{S(n)} = \frac{n}{S((n(n+1))/2)}.$$

12) Solve the following equation in integers:

$$S(1*2) + S(2*3) + \dots + S(n(n+1)) = S((n(n+1)(n+2))/3).$$

13. Let $\alpha_k(n)$ be the first k digits of n and $\beta_p(n)$ the last p digits of n . Determine all integer 5-tuples (n, m, r, k, p) for which:

$$S^2(\alpha_k(n)) = S^2(\alpha_k(m)) + S^2(\alpha_k(r))$$

and

$$S^2(\beta_p(n)) = S^2(\beta_p(m)) + S^2(\beta_p(r)).$$

14) Determine all integer 5-tuples (n, m, r, k, p) for which:

$$\alpha_k^2(S(n)) = \alpha_k^2(S(m)) + \alpha_k^2(S(r))$$

and

$$\beta_k^2(S(n)) = \beta_k^2(S(m)) + \beta_k^2(S(k)).$$

15) Determine all integer pairs (n, k) for which:

$$\alpha_{k+2}^2(S(n)) = \alpha_{k+1}^2(S(n)) + \alpha_k^2(S(n)).$$

16) Determine all integer pairs (n,p) for which:

$$\beta_{p+2}^2(S(n)) = \beta_{p+1}^2(S(n)) + \beta_p^2(S(n)).$$

17) Find all integer pairs (n,k) such that

$$S(\alpha_k(n)) + S(\alpha_k(n+2)) = 2 * S(\alpha_k(n+1))$$

18) Find all integer pairs (n,p) such that

$$S(\beta_p(n)) + S(\beta_p(n+2)) = 2*S(\beta_p(n+1))$$

19) Let p_n be the n -th prime number. Determine all integer triples (n,k,p) for which

$$S(\alpha_k(p_n)) + S(\beta_p(p_n)) = 2 * S(\alpha_{(k+p)/2}(p_n))$$

and

$$S(\alpha_k(p_n)) + S(\beta_p(p_n)) = 2 * S(\beta_{(k+p)/2}(p_n)).$$

20) Find all integer pairs (a,b) such that

$$\frac{a*S(b) + b*S(a)}{a+b} = S \left[\frac{a^2 + b^2}{a+b} \right]$$

21) Solve the following in integers:

$$\pm S(\sigma(1)) \pm S(\sigma(2)) \pm \dots \pm S(\sigma(n)) = \pm \sigma(\pm S(1) \pm S(2) \pm \dots \pm S(n)).$$

22) Solve the following in integers:

$$\alpha_k(n) = S(n) \quad \text{and} \quad \beta_p(n) = S(n).$$

23) Solve the following in integers:

$$\alpha_k(n!) = S(m) \quad \text{and} \quad \beta_p(n!) = S(m).$$

ON SMARANDACHE ALGEBRAIC STRUCTURES, I: THE COMMUTATIVE MULTIPLICATIVE SEMIGROUP $A(a, n)$

Maohua Le

Abstract . In this paper , under the Smarandache algorithm , we construct a class of commutative multiplicative semigroups .

Key words . Smarandache algorithm , commutative multiplicative semigroup .

In this serial papers we consider some algebraic structures under the Smarandache algorithm (see [2]). Let n be a positive integer with $n > 1$, and let

$$(1) \quad n = p_1^{r_1} p_2^{r_2} \cdots p_k^{r_k}$$

be the factorization of n , where p_1, p_2, \dots, p_k are prime with $p_1 < p_2 < \cdots < p_k$ and r_1, r_2, \dots, r_k are positive integers . Further , let

$$(2) \quad n' = p_1 p_2 \cdots p_k .$$

Then , for any fixed nonzero integer a , there exist unique integers b, c, l, m, l', m' such that

$$(3) \quad a = bc, \quad n = lm, \quad n' = l'm',$$

$$(4) \quad l' = \gcd(l, n'), \quad m' = \gcd(m, n'),$$

$$(5) \quad l = \gcd(a, n'), \quad \gcd(c, n) = 1,$$

and every prime divisor of b divides l' . Let

$$(6) \quad e = \begin{cases} 0, & \text{if } l' = 1, \\ \text{the least positive integer} \\ \text{which make } l \mid a^e, & \text{if } l' > 1. \end{cases}$$

Since $\gcd(a, m) = 1$, by the Fermat - Euler theorem (see [1, Theorem 72]), there exists a positive integer t such that

$$(7) \quad a^f \equiv 1 \pmod{m}.$$

Let f be the least positive integer t satisfying (7). For any fixed a and n , let the set

$$(8) \quad A(a,n) = \begin{cases} \{1, a, \dots, a^{f-1}\} \pmod{n}, & \text{if } f=1, \\ \{a, a^2, \dots, a^{e+f-1}\} \pmod{n}, & \text{if } f>1. \end{cases}$$

In this paper we prove the following result.

Theorem. Under the Smarandache algorithm, $A(a,n)$ is a commutative multiplicative semigroup.

Proof. Since the commutativity and the associativity of $A(a,n)$ are clear, it suffices to prove that $A(a,n)$ is closed.

Let a^i and a^j belong to $A(a,n)$. If $i+j \leq e+f-1$, then from (8) we see that $a^i a^j = a^{i+j}$ belongs to $A(a,n)$. If $i+j > e+f-1$, then $i+j \geq e+f$. Let $u = i+f-e$. Then there exists unique integers v, w such that

$$(9) \quad u = fv + w, \quad u \geq 0, \quad f > w \geq 0.$$

Since $a^f \equiv 1 \pmod{m}$, we get from (9) that

$$(10) \quad a^{i+j-e} - a^w \equiv a^u - a^w \equiv a^{fv+w} - a^w \equiv a^w - a^w \equiv 0 \pmod{m}.$$

Further, since $\gcd(l,m)=1$ and $a^e \equiv 0 \pmod{l}$ by (6), we see from (10) that

$$(11) \quad a^{i+j} \equiv a^{e+w} \pmod{m}.$$

Notice that $e \leq e+w \leq e+f-1$. We find from (11) that a^{i+j} belongs to $A(a,n)$. Thus the theorem is proved.

References

- [1] G H Hardy and E M Wright, An Introduction to the Theory of Numbers, Oxford Universit Press, Oxford, 1937.
- [2] R. Padilla, Smardandche algebraic structures, Smarandache Notions J. 9(1998), 36-38.

Department of Mathematics
Zhanjiang Normal College
Zhanjiang, Guangdong
P.R. CHINA

ON SMARANDACHE ALGEBRAIC STRUCTURES. II:THE SMARANDACHE SEMIGROUP

Maohua Le

Abstract . In this paper we prove that $A(a,n)$ is a Smarandache semigroup.

Key words . Smarandache algorithm , Smarandache semigroup .

Let G be a semigroup . If G contains a proper subset which is a group under the same operation , then G is called a Smarandache semigroup (see [2]) . For example , $G=\{18,18^2,18^3,18^4,18^5\} \pmod{60}$ is a commutative multiplicative semigroup . Since the subset $\{18^2,18^3,18^4,18^5\} \pmod{60}$ is a group , G is a Smarandache semigroup .

Let a,n be integers such that $a \neq 0$ and $n > 1$. Further , let $A(a,n)$ be defined as in [1] . In this paper we prove the following result .

Theorem . $A(a,n)$ is a Smarandache semigroup .

Proof . Under the definitions and notations of [1] , let $A'(a,n)=\{a^e, a^{e+1}, \dots, a^{e+f-1}\} \pmod{n}$. Then $A'(n,a)$ is a proper subset of $A(a,n)$.

If $e=0$, then $a^e = 1 \in A'(a,n)$. Clear , 1 is the unit of $A'(a,n)$. Moreover , for any $a^i \in A(a,n)$ with $i > 0$, a^i is the inverse element of a^i in $A'(a,n)$.

If $e > 0$, then $a^f \in A'(a,n)$. Since $a^f \equiv 1 \pmod{m}$, a^f is the unit of $A'(a,n)$ and a^{ft-i} is the inverse element of a^i in $A'(a,n)$, where t is the integer satisfying $e < ft-i \leq e+f-1$. Thus , under the Smarandache algorithm , $A'(a,n)$ is a group . It implies that $A(a,n)$ is a Smarandache

semigroup. The theorem is proved.

References

- [1] M.-H. Le, On Smarandache algebraic structures I: The commutative multiplicative semigroup $A(a,n)$, Smarandache Notions J. , 12(2001).
- [2] R. Padilla , Smarandache algebraic structures , Smarandache Notions J. 9(1998) , 36-38 .

Department of Mathematics
Zhanjiang Normal College
Zhanjiang , Guangdong
P.R. CHINA

ON SMARANDACHE ALGEBRAIC STRUCTURES.
III : THE COMMUTATIVE RING $B(a,n)$

Maohua Le

Abstract In this paper we construct a class of commutative rings under the Smarandache algorithm.

Key words . Smarandache algorithm , commutative ring .

Let a,n be integers such that $a \neq 0$ and $n > 1$. Under the definitions and notions in [1], let

$$(1) \quad B(a,n) = \begin{cases} \{0,1,a,\dots,a^{f-1}\} \pmod{n}, & \text{if } l=1, \\ \{0,a,a^2,\dots,a^{e+f-1}\} \pmod{n}, & \text{if } l > 1. \end{cases}$$

In this paper we prove the following result.

Theorem . If m is a prime and a is a primitive root modulo m , then $B(a,n)$ is a commutative ring under the Smarandache additive and multiplicative.

Proof . Since $B(a,n) = A(a,n) \cup \{0\}$ by (1) , $B(a,n)$ is a commutative multiplicative semigroup under the Smarandache algorithm (see [2]).

Notice that m is a prime and a is a primitive root modulo m . Then we have $f = m - 1$. If $l = 1$, then $B(a,n) = \{0,1,2, \dots, m-1\} \pmod{m}$. Therefore , $B(a,n)$ is a commutative additive group . It implies that $B(a,n)$ is a commutative ring under additive and multiplicative . If $l > 1$, since $l \mid a^e$, then from (1) we see that $B(a,n) = \{0,l,2l,\dots,(m-1)l\} \pmod{n}$. Therefore , $B(a,n)$ is also a commutative ring . The theorem is proved .

References

- [1] M.-H. Le , On Smarandache algebraic structures I: The commutative multiplicative semigroup $A(a,n)$, Smarandache Notions J., 12(2001).
- [2] R.Padilla , Smarandache algebraic structures , Smarandache Notions J. 9(1998),36-38.

Department of Mathematics
Zhanjiang Normal College
Zhanjiang , Guangdong
P.R. CHINA

ON SMARANDACHE ALGEBRAIC STRUCTURES.

IV : THE COMMUTATIVE RING $C(a,n)$

Maohua Le

Abstract. In this paper we construct a new class of commutative rings under the Smarandache algorithm.

Key words. Smarandache algorithm, commutative ring.

Let a, n be integers such that $a \neq 0$ and $n > 1$. Let $d = \gcd(a, n)$, $b = a/d$ and $t = n/d$. Further, let

$$(1) \quad C(a, n) = \{0, a, 2a, \dots, (t-1)a\} \pmod{n}.$$

In this paper we prove the following result.

Theorem. $C(a, n)$ is a commutative ring under the Smarandache additive and multiplicative.

Proof. Let u, v be two elements of $C(a, n)$. By (1), we have

$$(2) \quad u = ia, \quad v = ja, \quad 0 \leq i, j \leq t-1.$$

Let r be the least nonnegative residue of $i+j$ modulo t . Since $d = \gcd(a, n)$ and $n = dt$, we get from (2) that

$$(3) \quad u + v \equiv (i+j)a \equiv ra \pmod{n}, \quad 0 \leq r \leq t-1.$$

It implies that $u+v$ belongs to $C(a, n)$. Therefore, it is a commutative additive group under the Smarandache algorithm (see [1]).

On the other hand, let r' be the least nonnegative residue of ija modulo t . By (2), we get

$$(4) \quad uv \equiv ija^2 \equiv r'a \pmod{n}, \quad 0 \leq r' \leq t-1.$$

Hence, by (4), $C(a, n)$ is a commutative multiplicative semigroup. Thus, $C(a, n)$ is a commutative ring. The theorem is proved.

Reference

- [1] R. Padilla , Smarandache algebraic structures , Smarandache Notions J. 9(1998) ,36-38 .

Department of Mathematics
Zhanjiang Normal College
Zhanjiang , Guangdong
P.R. CHINA

ON SMARANDACHE ALGEBRAIC STRUCTURES. V : TWO CLASSES OF SMARANDACHE RINGS

Maohua Le

Abstract . In this paper we construct two classes of Smarandache rings .

Key words . Smarandache algorithm , Smarandache ring .

Let R be a ring . If R contains a proper subset , which is a field under the same operations , then R is called a Smarandache ring (see [4]) . For example , by the result of [3] , $R=C(6,60)=\{0,6,12,18,24,30,36,42,48,56\} \pmod{60}$ is a ring . Since the proper subset $\{0,12,24,36,48\} \pmod{60}$ of $C(6,60)$ is a field , $C(6,60)$ is a Smarandache ring .

Under the definitions and notions of [1] , [2] and [3] , we now construct two classes of Smarandache rings as follows .

Theorem 1 . If m is a prime and a is a primitive root modulo m , then $B(a,n)$ is a Smarandache ring .

Theorem 2 . If t has a prime divisor p with $p \nmid d$, then $C(a,n)$ is a Smarandache ring .

Proof of Theorem 1 . Since $B(a,n)$ has a proper subset $\{0, a^e, 2a^e, \dots, (m-1)a^e\} \pmod{n}$, which is a field . Thus , it is a Smarandache ring .

Proof of Theorem 2 . Since $C(a,n)$ has a proper subset $\{0, at/p, 2at/p, \dots, (p-1)at/p\} \pmod{n}$, which is a field . Thus , it is a Smarandache ring .

References

- [1] M.-H. Le, On Smarandache algebraic structures I: The Commutative multiplicative semigroup, Smarandache Notions, J. , 12(2001).
- [2] M.-H. Le , On Smarandache algebraic structures III: The commutative ring $B(a,n)$, Smarandache Notions J. , 12(2001).
- [3] M.-H. Le , On Smarandache algebraic structures IV: The commutative ring $C(a,n)$, Smarandache Notions J. , 12(2001).
- [4] R.Padilla , Smarandache algebraic structures , Smarandache Notions J. 9(1998),36-38 .

Department of Mathematics
Zhanjiang Normal College
Zhanjiang , Guangdong
P.R. CHINA

A NOTE ON THE SMARANDACHE BAD NUMBERS

Maohua Le

Abstract . In this paper we show that 7 and 13 are not Smarandache bad numbers . Moreover , we give a criterion for the Smarandache bad numbers .

Key words . Smarandache bad number , criterion program .

Let a be a positive integer . If a cannot be expressed as the absolute value of difference between a cube and a square , then a is called a Smarandache bad number . Smarandache [2] conjectured that the numbers 5,6,7,10,13,14,...are probably such bad numbers . However , since

$$(1) \quad 7 = | 2^3 - 1^2 | , \quad 13 = | 17^3 - 70^2 | ,$$

we find that 7 and 13 are not Smarandache bad numbers .

On the other hand , by a result of Bakera [1] , we give the following criterion for the Smarandache bad numbers immediately .

Theorem . For any fixed positive integer a , if

$$(2) \quad a \neq | x^3 - y^2 |$$

for every positive integer pairs (x,y) with

$$(3) \quad \log \max (x,y) \leq 10^{10} a^{10000} ,$$

then a is a Smarandache bad number .

References

- [1] A.Baker , The diophantine equation $y^2 = x^3 + k$, Phil .
Trans . Roy . Soc . London 263(1968),193-208 .
- [2] F. Smarandache , Properties of Numbers , University of
Craiova Archives , 1975 .

Department of Mathematics
Zhanjiang Normal College
Zhanjiang , Guangdong
P.R. CHINA

A LOWER BOUND FOR $S(2^{p-1}(2^p-1))$

Maohua Le

Abstract. Let p be a prime, and let $n=2^{p-1}(2^p-1)$. In this paper we prove that $S(n) \geq 2p+1$.

Key words. Smarandache function, function value, lower bound.

For any positive integer a , let $S(a)$ be the Smarandache function. In [2], Sandor showed that if

$$(1) \quad n=2^{p-1}(2^p-1)$$

is an even perfect number, then $S(n)=2^p-1$. It is a well known fact that if n is an even perfect number, then p must be a prime. But, its inverse proposition is false (see [1, Theorems 18 and 276]). In this paper we give a lower bound for $S(n)$ in the general cases. We prove the following result.

Theorem. If p is a prime and n can be expressed as (1), then $S(n) \geq 2p+1$.

Proof. Let

$$(2) \quad 2^p-1=q_1^{r_1} q_2^{r_2} \dots q_t^{r_t}$$

be the factorization of 2^p-1 , where q_1, q_2, \dots, q_t are primes with $q_1 < q_2 < \dots < q_t$ and r_1, r_2, \dots, r_t are positive integers. By (1) and (2), we get

$$(3) \quad S(n) = \max(S(2^{p-1}), S(q_1^{r_1}), S(q_2^{r_2}), \dots, S(q_t^{r_t})).$$

It is a well known fact that $q_i \equiv 1 \pmod{2p}$ for $i=1, 2, \dots, t$. So we have

$$(4) \quad 2p+1 \leq q_1 < q_2 < \dots < q_t.$$

Since $q_i = S(q_i) \leq S(q_i^{r_i})$ for $i=1, 2, \dots, t$, we get from (4) that

$$(5) \quad 2p+1 \leq \max(S(q_1^{r_1}), S(q_2^{r_2}), \dots, S(q_i^{r_i})).$$

On the other hand, if m is the largest integer such that $(2p+1)!$ is a multiple of 2^m , then

$$(6) \quad m = \sum_{k=1}^{\infty} \left[\frac{2p+1}{2^k} \right] \geq \left[\frac{2p+1}{2} \right] = p.$$

It implies that $2^p \mid (2p+1)!$. So we have

$$(7) \quad S(2^{p-1}) \leq S(2^p) \leq 2p+1.$$

Thus, by (3), (5) and (7), we obtain $S(n) \geq 2p+1$. The theorem is proved.

References

- [1] G.H.Hardy and E.M. Wright, An introduction to the Theory of Numbers, Oxford University Press, Oxford, 1937.
- [2] J.Sandor, A note on $S(n)$, where n is an even perfect number, Smarandache Notions J.11(2000),139.

Department of Mathemaics
 Zhanjing Normal College
 Zhanjing, Guangdong
 P.R. CHINA

THE SQUARES IN THE SMARANDACHE HIGHER POWER PRODUCT SEQUENCES

Maohua Le

Abstract . In this paper we prove that the Smarandache higher power product sequences of the first kind and the second kind do not contain squares.

Key words . Smarandache product sequence, higher power, square.

Let r be a positive integer with $r > 3$, and let $A(n)$ be the n -th power of degree r . Further, let

$$(1) \quad p(n) = \prod_{k=1}^n A(k)+1$$

and

$$(2) \quad Q(n) = \prod_{k=1}^n A(k)-1.$$

Then the sequences $P = \{P(n)\}_{n=1}^{\infty}$ and $Q = \{Q(n)\}_{n=1}^{\infty}$ are called the Smarandache higher power product sequences of the first kind and the second kind respectively. In this paper we consider the squares in P and Q . We prove the following result.

Theorem . For any positive integer r with $r > 3$, the sequences P and Q do not contain squares.

Proof . By (1), if $P(n)$ is a square, then we have

$$(3) \quad (n!)^r + 1 = a^2,$$

where a is a positive integer. It implies that the equation

$$(4) \quad x^m+1=y^2, \quad m>3$$

has a positive integer solution $(x,y,m)=(n!,a,r)$. However, by the result of [1], the equation (4) has no positive integer solution (x,y,m) . Thus, the sequence P does not contain squares.

Similarly, by (2), if $Q(n)$ is a square, then we have

$$(5) \quad (n!)^r-1=a^2,$$

where a is a positive integer. It implies that the equation

$$(6) \quad x^m-1=y^2, m>3.$$

has a positive integer solution $(x,y,m)=(n!,a,r)$. However, by the result of [2], it is impossible. Thus, the sequence Q does not contain squares. The theorem is proved.

References

- [1] C.Ko, On the diophantine equation $x^2=y^n+1, xy \neq 0$, Sci, Sinica, 14 (1964), 457-460.
- [2] V.A. Lebesgue, Sur l'impossibilité, en nombres entiers, de l'équation $x^m=y^2+1$, Nouv. Ann. Math. (1), 9 (1850), 178-181.

Department of Mathematics
Zhanjiang Normal College
Zhanjiang, Guangdong
P.R. CHINA

THE POWERS IN THE SMARANDACHE SQUARE PRODUCT SEQUENCES

Maohua Le

Abstract . In this paper we prove that the Smarandache square product sequences of the first kind and the second kind do not contain powers.

Key words . Smarandache square product sequence, power.

For any positive integer n , let $A(n)$ be the n -th square. Further, let

$$(1) \quad P(n) = \prod_{k=1}^n A(k)+1$$

and

$$(2) \quad Q(n) = \prod_{k=1}^n A(k)-1.$$

Then the sequences $P = \{P(n)\}_{n=1}^{\infty}$ and $Q = \{Q(n)\}_{n=1}^{\infty}$ are called the Smarandache square product sequences of the first kind and the second kind respectively (see [3]). In this paper we consider the powers in P and Q . We prove the following result.

Theorem . The sequences P and Q do not contain powers .

Proof . If $P(n)$ is a power, then from (1) we get

$$(3) \quad (n!)^2 + 1 = a^r,$$

where a and r are positive integers satisfying $a > 1$ and $r > 1$. It implies that the equation.

$$(4) \quad X^2+1=Y^m, m>1,$$

has a positive integer solution $(X, Y, m) = (n!, a, r)$. However, by the result of [2], the equation (4) has no positive integer solution (X, Y, m) . Thus, the sequence P does not contain powers.

Similarly, by (2), if $Q(n)$ is a power, then we have

$$(5) \quad (n!)^2-1=a^r,$$

where a and r are positive integers satisfying $a>1$ and $r>1$. It implies that the equation

$$(6) \quad X^2-1=Y^m, X>1, m>1,$$

has a positive integer solution $(X, Y, m) = (n!, a, r)$. By the result of [1], (5) has only the solution $(X, Y, m) = (3, 2, 3)$. Notice that $1! = 1, 2! = 2$ and $n! \geq 6$ for $n \geq 3$. Therefore, (4) is impossible. The theorem is proved.

References

- [1] C. Ko, On the diophantine equation $x^2=y^n+1, xy \neq 0$, *Sci. Sinica*, 14(1964), 457-460.
- [2] V.A. Lebesgue, Sur l'impossibilité, en nombres entiers, de l'équation $x^m=y^2+1$, *Nouv. Ann. Math. (1)*, 9(1850), 178-181.
- [3] F. Russo, Some results about four Smarandache U-product sequences, *Smarandache Notions J.* 11(2000), 42-49.

Department of Mathematics
Zhanjiang Normal College
Zhanjiang, Guangdong
P.R. CHINA

THE POWERS IN THE SMARANDACHE CUBIC PRODUCT SEQUENCES

Maohua Le

Abstract. Let P and Q denote the Smarandache cubic product sequences of the first kind and the second kind respectively. In this paper we prove that P contains only one power 9 and Q does not contain any power.

Key words. Smarandache cubic product sequence, power.

For any positive integer n , Let $C(n)$ be the n -th cubic. Further, let

$$(1) \quad P(n) = \prod_{k=1}^n C(k)+1$$

and

$$(2) \quad Q(n) = \prod_{k=1}^n C(k)-1.$$

Then the sequences $P = \{P(n)\}_{n=1}^{\infty}$ and $Q = \{Q(n)\}_{n=1}^{\infty}$ are called the Smarandache cubic product sequence of the first kind and the second kind respectively (see [5]). In this paper we consider the powers in P and Q . We prove the following result.

Theorem. The sequence P contains only one power $P(2)=3^2$. The sequence Q does not contain any power.

Proof. If $P(n)$ is a power, then from (1) we get

$$(3) \quad (n!)^3+1=a^r,$$

$$(3) \quad (n!)^3+1=a^r,$$

where a and r are positive integers satisfying $a>1$ and $r>1$, By (3), if $2 \mid r$, then the equation

$$(4) \quad X^3+1=Y^2$$

has a positive integer solution $(X,Y)=(n!, a^{r/2})$. Using a well known result of Euler (see [3,p.302]), (4) has only one positive integer solution $(X,Y)=(2,3)$. It implies that P contain only one power $P(2)=3^2$ with $2 \mid r$. If $2 \nmid r$, then the equation

$$(5) \quad X^3+1=Y^m, m>1, 2 \nmid m$$

has a positive integer solution $(X,Y,m)=(n!, a, r)$. However, by [4], it is impossible. Thus, P contains only one power $P(2)=3^2$.

Similarly, by(2), if $Q(n)$ is a power, then we have

$$(6) \quad (n!)^3-1=a^r,$$

where a and r are positive integers satisfying $a>1$ and $r>1$, It implies that the equation.

$$(7) \quad X^3-1=Y^m, m>1,$$

has a positive integer solution $(x,Y,m)=(n!, a, r)$. However, by the results of [2] and [4], it is impossible. Thus, the suquence Q does not contain any power. The theorem is proved.

References

- [1] C.Ko, On the diophantine equation $x^2=y^n+1, 0 \neq xy$, Sci. Sinica 14(1964),457-460.
- [2] V.A.Lebesgue, Sur l'impossibilité, en nombres entiers, de l'équation $x^m=y^2+1$, Nouv, Ann. Math. (1), 9(1850),178-181.
- [3] L.j.Mordell, Diophantine Equations, Academic Press,

London, 1969.

- [4] T.Nagell, Des équations indéterminées $x^2+x+1=y^n$ et $x^2+x+1=3y^n$, Norsk. Mat Forenings Skr. Ser. I, 2(1921), 12-14.
- [5] F.Russo, Some results about four Smarandache U-product sequences, Smarandache Notions J. 11(2000), 42-49.

Department of Mathematics
Zhanjiang Normal College
Zhanjiang, Guangdong
P.R.CHINA

ON THE SMARANDACHE UNIFORM SEQUENCES

Maohua Le

Abstract. Let t be a positive integer with $t > 1$. In this paper we give a necessary and sufficient condition for t to have the Smarandache uniform sequence.

Key words. Smarandache uniform sequence, decimal notation.

Let t be a positive integer with $t > 1$. If a sequence contains all multiples of t written with same digit in base 10, then it is called the Smarandache uniform sequence of t . In [2], Smith showed that such sequence may be empty for some t .

In this paper we give a necessary and sufficient condition for t to have the Smarandache uniform sequence. Clearly, the positive integer t can be expressed as

$$(1) \quad t = 2^a 5^b c,$$

where a, b are nonnegative integers, c is a positive integer satisfying $\gcd(10, c) = 1$. We prove the following result.

Theorem. t has the Smarandache uniform sequence if and only if

$$(2) \quad (a, b) = (0, 0), (1, 0), (2, 0), (3, 0), (0, 1).$$

Proof. Clearly, t has the Smarandache uniform sequence if and only if there exists a multiple m of t such that

$$(3) \quad m = dd\dots d, 1 \leq d \leq 9.$$

By (1) and (3), we get

$$(4) \quad ts=2^a5^bcs=m=d \frac{10^r-1}{10-1},$$

where r, s are positive integers. From (4), we obtain

$$(5) \quad 2^a5^b9cs=d(10^r-1).$$

Since $\gcd(2^a5^b, 10^r-1)=1$, we see from (5) that d is a multiple of 2^a5^b . Therefore, since $1 \leq d \leq 9$, we obtain the condition (2).

On the other hand, since $\gcd(10, 9c)=1$, by Fermat-Euler theorem (see [1, Theorem 72]), There exists a positive integer r such that 10^r-1 is a multiple of $9c$. Thus, if (2) holds, then t has Smarandache uniform sequence. The theorem is proved.

References

- [1] G.H.Hardy and E.M.Wright, An Introduction to the Theory of Numbers, Oxford University Press, Oxford, 1937.
- [2] S.Smith, A set of conjectures on Smarandache sequences, Smarandache Notions J. 11(2000), 86-92.

Department of Mathematics
Zhanjiang Normal College
Zhanjiang, Guangdong
P.R.CHINA

THE PRIMES IN THE SMARANDACHE POWER PRODUCT SEQUENCES OF THE SECOND KIND

Maohua Le

Abstract. In this paper we completely determine the primes in the Smarandache power product sequences of the second kind.

Key words . Smarandache power product sequencem , second kind, prime.

For any positive integers n, r with $r > 1$, let $P(n, r)$ be the n -th power of degree r . Further, let

$$(1) \quad U(n, r) = \prod_{k=1}^n P(k, r) - 1.$$

Then the sequence $U(r) = \{U(n, r)\}_{n=1}^{\infty}$ is called the Smarandache r -power product sequence of the second kind. In [2], Russo proposed the following question.

Question. How many terms in $U(2)$ and $U(3)$ are primes?

In this paper we completely solve the mentioned question. We prove a more strong result as follows.

Theorem. If r and $2^r - 1$ are both primes, then $U(r)$ contains only one prime $U(2, r) = 2^r - 1$. Otherwise, $U(r)$ does not contain any prime.

Proof. Since $U(1, r) = 0$, we may assume that $n > 1$. By (1), we get

$$(2) \quad U(n, r) = (n!)^r - 1 = (n! - 1)((n!)^{r-1} + (n!)^{r-2} + \dots + 1).$$

Since $n! > 2$ if $n > 2$, we see from (2) that $U(n, r)$ is not a prime if $n > 2$. When $n = 2$, we get from (2) that

(3) $U(2,r)=2^r-1$.

Therefore, by [1,Theorem 18], we find from (3) that $U(r)$ contains a prime if and only if r and 2^r-1 are both primes. The theorem is proved.

References

- [1] G.H.Hardy and E.M.Wright, An Introduction to the Theory of Numbers, Oxford University Press, Oxford, 1937.
- [2] F.Russo, Some results about four Smarandache U-product sequences, Smarandache Notions J.11(2000),42-49.

Department of Mathematics
Zhanjiang Normal College
Zhanjiang, Guangdong
P.R.CHINA

THE PRIMES IN THE SMARANDACHE POWER PRODUCT SEQUENCES OF THE FIRST KIND

Maohua Le

Abstract. In this paper we prove that if $r > 1$ and r is not a power of 2, then the Smarandache r -power product sequence of the first kind contains only one prime 2.

Key words . Smarandache power product sequence, first kind, prime.

For any positive integers n, r with $r > 1$, let $P(n, r)$ be the n -th power of degree r . Further, let

$$(1) \quad V(n, r) = \prod_{k=1}^n P(k, r) + 1.$$

Then the sequence $V(r) = \{V(n, r)\}_{n=1}^{\infty}$ is called the Smarandache r -power product sequence of the first kind. In [2], Russo proposed the following question.

Question . How many terms in $V(2)$ and $V(3)$ are primes?

In fact, Le and Wu [1] showed that if r is odd, then $V(r)$ contains only one prime 2. It implies that $V(3)$ contains only one prime 2. In this paper we prove a general result as follows.

Theorem . If r is not a power of 2, then $V(r)$ contains only one prime 2.

Proof. Since $r > 1$, if r is not a power of 2, then r has an odd prime divisor p . By (1), we get

$$V(n, r) = (n!)^r + 1 = ((n!)^{r/p} + 1)((n!)^{r(p-1)/p} - (n!)^{r(p-2)/p} + \dots - (n!)^{r/p} + 1),$$

Where r/p is a positive integer. Notice that if $n > 1$, then $(n!)^{r/p} + 1 > 1$ and $(n!)^{r(p-1)/p} + 1 > 1$. Therefore, we see from (2) that if $n > 1$, then $V(n, r)$ is not a prime. Thus, the sequence $V(r)$ contains only one prime $V(1, r) = 2$. The theorem is proved.

References

- [1] M.-H. Le and K.-J. Wu, The primes in Smarandache power product sequences, Smarandache Notions J. 9(1998), 97-98.
- [2] F. Ruso, Some results about four Smarandache U-product sequences, Smarandache Notions J. 11(2000), 42-49.

Department of Mathematics
Zhanjiang Normal College
Zhanjiang, Guangdong
P.R. CHINA

ON THE EQUATION $S(mn)=m^k S(n)$

Maohua Le

Abstract. In this paper we prove that the equation $S(mn)=m^k S(n)$ has only the positive integer solution $(m,n,k)=(2,2,1)$ with $m>1$ and $n>1$.

Key words Smarandache function, equation, positive integer solution .

For any positive integer a , let $S(a)$ be the Smarandache function. Muller [2, Problem 21] proposed a problem concerning the integer solutions (m,n,k) of the equation

$$(1) \quad S(mn)=m^k S(n), \quad m > 1, n > 1.$$

In this paper we determine all solutions of (1) as follows.

Theorem. The equation (1) has only the solution $(m,n,k)=(2,2,1)$.

Proof. By [1, Theorem], we have

$$(2) \quad S(mn) \leq S(m)+S(n).$$

Hence, if (m,n,k) is a solution of (1), then from (2) we obtain

$$(3) \quad m^k S(n) \leq S(m)+S(n).$$

By (3), we get

$$(4) \quad m^k \leq \frac{S(m)}{S(n)} + 1.$$

Since $S(m) \leq m$, we see from (4) that

$$(5) \quad m^k \leq \frac{m}{S(n)} + 1.$$

If $n>2$, then $S(n) \geq 3$ and

$$(6) \quad m \leq m^k \leq \frac{m}{3} + 1,$$

by (5). However, we get from (6) that $m \leq 1/2$, a

contradiction. So we have $n=2$. Then, we get $S(n)=2$ and

$$(7) \quad m^k \leq \frac{m}{2} + 1$$

by (5).

If $m > 2$, then $m/2 > 1$, and

$$(8) \quad m \leq m^k < \frac{m}{2} + \frac{m}{2} = m$$

by (7). This is a contradiction. Therefore, we get $m=2$ and

$$(9) \quad 2^k \leq 1 + 1 = 2,$$

by (7). Thus, we see from (9) that (1) has only the solution $(m, n, k) = (2, 2, 1)$. The theorem is proved.

References

- [1] M.-H. Le, An inequality concerning the Smarandache function, *Smarandache Notions J.* 9(1998), 124-125.
- [2] R. Muller, *Unsolved Problems Related to Smarandache Function*, Number Theory Publishing Company, 1997.

Department of Mathematics
Zhanjiang Normal College
Zhanjiang, Guangdong
P.R. CHINA

ON AN INEQUALITY CONCERNING THE SMARANDACHE FUNCTION

Maohua Le

Abstract. Let a, n be positive integers. In this paper we prove that $S(a)S(a^2)\dots S(a^n) \leq n!(S(a))^n$.

Key words Smarandache function, inequality.

For any positive integer a , let $S(a)$ be the Smarandache function. In [1], Bencze proposed the following problem.

Problem. For any positive integers a and n , prove the inequality.

$$(1) \quad \prod_{k=1}^n S(a^k) \leq n!(S(a))^n.$$

In this paper we completely solve this problem. We prove the following result.

Theorem. For any positive integers a and n , the inequality (1) holds.

Proof By [2, Theorem], we have

$$S(ab) \leq S(a) + S(b),$$

for any positive integers a and b . It implies that

$$(2) \quad S(a^k) \leq kS(a),$$

for any positive integers a and k . Therefore, by (2), we get

$$(3) \quad \prod_{k=1}^n S(a^k) \leq \prod_{k=1}^n (kS(a)) = n!(S(a))^n.$$

Thus, the inequality (1) is proved.

References

- [1] M.Bencze, PP.1388, Octogon Math. Mag.,7(1999),2:149.
- [2] M.-H.Le, An inequality concerning the Smarandache function, Smarandache Notions J. 9(1998),124-125.

Department of Mathemaics
Zhanjiang Normal College
Zhanjiang , Guangdong
P . R . CHINA

THE SQUARES IN THE SMARANDACHE FACTORIAL PRODUCT SEQUENCE OF THE SECOND KIND

Maohua Le

Abstract . In this paper we prove that the Smarandache factorial product sequence contains only one square 1.

Key words . Smarandache product sequence, factorial, square.

For any positive integer n , let

$$(1) \quad F(n) = \prod_{k=1}^n k! - 1.$$

Then the sequence $F = \{F(n)\}_{n=1}^{\infty}$ is called the Smarandache factorial product sequence of the second kind (see [2]). In this paper we completely determine squares in F . We prove the following result.

Theorem . The Smarandache factorial product sequence of the second kind contains only one square $F(2)=1$.

Proof. Since $F(1)=0$ by (1), we may assume that $n>1$. If $F(n)$ is a square, then from (1) we get

$$(2) \quad a^2 = \prod_{k=1}^n k!,$$

where a is a positive integer. By [1, Theorem 82], if p is a prime divisor of a^2+1 , then either $p=2$ or $p \equiv 1 \pmod{4}$. Therefore, we see from (2) that $n<3$. Since $F(2)=1$ is a square, the theorem is proved.

References

- [1] G.H Hardy and E.M. Wright, An Introduction to the Theory of Numbers, Oxford University Press, Oxford, 1937.
- [2] F. Russo, Some results about four Smarandache U-product sequence, Smarandache Notions J. 11(2000)42-49.

Department of Mathematics
Zhanjiang Normal College
Zhanjiang , Guangdong
P.R. CHINA

ON THE THIRD SMARANDACHE CONJECTURE ABOUT PRIMES

Maohua Le

Abstract . In this paper we basically verify the third Smarandache conjecture on prime.

Key words . Smarandache third conjecture, prime , gap.

For any positive integer n , let $P(n)$ be the n -th prime. Let k be a positive integer with $k > 1$, and let

$$(1) \quad c(n,k) = (P(n+1))^{1/k} - (P(n))^{1/k} .$$

Smarandache [3] has been conjectured that

$$(2) \quad C(n,k) < \frac{2}{k} .$$

In [2], Russo verified this conjecture for $P(n) < 2^{25}$ and $2 \leq k \leq 10$. In this paper we prove a general result as follows .

Theorem . If $k > 2$ and $n > C$, where C is an effectively computable absolute constant, then the inequality (2) holds.

Proof . Since $k > 2$, we get from (1) that

$$(3) \quad C(n,k) = \frac{P(n+1) - P(n)}{(P(n+1))^{(k-1)/k} + (P(n+1))^{(k-2)/k}(P(n))^{1/k} + \dots + (P(n))^{(k-1)/k}}$$

$$< \frac{P(n+1) - P(n)}{k(P(n))^{(k-1)/k}} \leq \frac{2}{k} \left[\frac{P(n+1) - P(n)}{2(P(n))^{2/3}} \right] .$$

By the result of [1], we have

$$(4) \quad P(n+1) - P(n) < C(a)(P(n))^{11/20+a} ,$$

for any positive number a , where $C(a)$ is an effectively

computable constant depending on a . Put $a=1/20$. Since $k \geq 3$ and $(k-1)/k \geq 2/3$, we see from (3) and (4) that

$$(5) \quad C(n,k) < \frac{2}{k} \left(\frac{C(1/20)}{2(P(n))^{1/15}} \right).$$

Since $C(1/20)$ is an effectively computable absolute constant, if $n > C$, then $2(P(n))^{1/15} > C(1/20)$. Thus, by (5), the inequality (2) holds. The theorem is proved.

References

- [1] D.R. Heath-Brown and H. Iwaniec, On the difference between consecutive primes, *Invent. Math.* 55(1979), 49-69.
- [2] F. Russo, An experimental evidence on the validity of third Smarandache conjecture on primes, *Smarandache Notions J.* 11(2000), 38-41.
- [3] F. Smarandache, Conjectures which generalized Andrica's conjecture, *Octagon Math. Mag.* 7(1999), 173-76.

Department of Mathematics
 Zhanjiang Normal College
 Zhanjiang, Guangdong
 P.R. CHINA

ON RUSSO'S CONJECTURE ABOUT PRIMES

Maohua Le

Abstract . Let n, k be positive integres with $k > 2$, and let b be a positive number with $b \geq 1$. In this paper we prove that if $n > C(k)$, where $C(k)$ is an effectively computable constant depending on k , then we have $C(n, k) < 2/k^b$.

Key words . Russo's conjecture, prime, gap, Smarandache constant.

For any positive integer n , let $P(n)$ be the n -th prime. Let k be a positive integer with $k > 1$, and let

$$(1) \quad C(n, k) = (P(n+1))^{1/k} - (P(n))^{1/k}.$$

In [2], Russo has been conjectured that

$$(2) \quad C(n, k) < \frac{2}{k^{2a}},$$

where $a = 0.567148130202017746468468755\dots$ is the Smarandache constant. In this paper we prove a general result as follows.

Theorem. For any positive number b with $b \geq 1$, if $k > 2$ and $n > C(k)$, where $C(k)$ is an effectively computable constant depending on k , then we have

$$(3) \quad C(n, k) < \frac{2}{k^b}.$$

Proof. Since $k > 2$, we get from (1) that

$$(4) \quad C(n, k) < \frac{2}{k^b} \left[\frac{(P(n+1) - P(n))k^{b-1}}{2(P(n))^{2/3}} \right].$$

By the result of [1], we have

$$(5) \quad P(n+1)-P(n) < C'(t)(P(n))^{11/20+t},$$

for any positive number t , where $C'(t)$ is an effectively computable constant depending on t . Put $t=1/20$. Since $k \geq 3$ and $(k-1)/k \geq 2/3$, we see from (4) and (5) that

$$(6) \quad C(n, k) < \frac{2}{k^b} \left[\frac{C'(1/20) k^{b-1}}{2(P(n))^{1/15}} \right].$$

Notice that $C'(1/20)$ is an effectively computable absolute constant and $P(n) > n$ for any positive integer n . Therefore, if $n > C(k)$, then $2(P(n))^{1/15} > C'(1/20)k^{b-1}$. Thus, by (6), the inequality (3) holds. The theorem is proved.

References

- [1] D.R. Heath-Brown and H. Iwaniec, On the difference between consecutive primes, *Invent. Math.* 55 (1979), 49-69.
- [2] F. Russo, An experimental evidence on the validity of third Smarandache conjecture on primes, *Smarandache Notions J.* 11(2000), 38-41.

Department of Mathematics
Zhanjiang Normal College
Zhanjiang, Guangdong
P.R. CHINA

A CONJECTURE CONCERNING THE RECIPROCAL PARTITION THEORY

Maohua Le

Abstract . In this paper we prove that there exist infinitely many disjoint sets of positive integers which the sum of whose reciprocals is equal to unity.

Key words . disjoint set of positive integers, sum of reciprocals, unity.

In [1] and [2] , Murthy proposed the following conjecture.

Conjecture . There are infinitely many disjoint sets of positive integers which the sum of whose reciprocals is equal to unity.

In this paper we completely verify the mentioned conjecture. For any positive integer n with $n \geq 3$, let $A(n) = \{a(n,1), a(n,2), \dots, a(n,n)\}$ be a disjoint set of positive integers having n elements, where $a(n,k)$ ($k=1,2,\dots,n$) satisfy

$$(1) \quad a(3,1)=2, \quad a(3,2)=3, \quad a(3,3)=6,$$

and

$$(2) \quad a(n,k) = \begin{cases} 2, & \text{if } k=1, \\ 2a(n-1,k-1), & \text{if } k>1, \end{cases}$$

for $n>3$. We prove the following result.

Theorem . For any positive integer n with $n \geq 3$, $A(n)$ is a disjoint set of positive integers satisfying

$$(3) \quad \frac{1}{a(n,1)} + \frac{1}{a(n,2)} + \dots + \frac{1}{a(n,n)} = 1.$$

Proof. We see from (1) and (2) that $a(n,1) < a(n,2) < \dots$

$\langle a(n,n) \rangle$. It implies that $A(n)$ is a disjoint set of positive integers. By (1), we get

$$(4) \quad \frac{1}{a(3,1)} + \frac{1}{a(3,2)} + \frac{1}{a(3,3)} = \frac{1}{2} + \frac{1}{3} + \frac{1}{6} = 1.$$

Hence, $A(n)$ satisfies (3) for $n=3$. Further, by (2) and (4), we obtain that if $n>3$, then

$$(5) \quad \left. \begin{aligned} &\frac{1}{a(n,1)} + \frac{1}{a(n,2)} + \dots + \frac{1}{a(n,n)} = \frac{1}{2} + \left[\frac{1}{2a(n-1,1)} + \right. \\ &\left. \frac{1}{2a(n-1,2)} + \dots + \frac{1}{2a(n-1,n-1)} \right] = \frac{1}{2} + \frac{1}{2} = 1. \end{aligned} \right\}$$

Therefore, by (5), $A(n)$ satisfies (3) for $n>3$. Thus, the theorem is proved.

References

- [1] A. Murthy, Smarandache maximum reciprocal representation function, Smarandache Notions J. 11(2000), 305-307.
- [2] A. Murthy, Open problems and conjectures on the factor/reciprocal partition theory, Smarandache Notions J. 11(2000), 308-311.

Department of Mathematics
Zhanjiang Normal College
Zhanjiang, Guangdong
P.R. CHINA

A SUM CONCERNING SEQUENCES

Maohua Le

Abstract . Let $A=\{a(n)\}_{n=1}^{\infty}$ be a sequence of positive integers. In this paper we prove that if the trailing digit of $a(n)$ is not zero for any n , then sum of $a(n)/\text{Rev}(a(n))$ is divergent.

Key words. decimal number, reverse, sequence of positive integers.

Let $\alpha=a_m \dots a_2 a_1$ be a decimal number . Then the decimal number $a_1 a_2 \dots a_m$ is called the reverse of α and denote by $\text{Rev}(\alpha)$. For example , if $\alpha=123$, then $\text{Rev}(\alpha)=321$. Let $S=\{s(n)\}_{n=1}^{\infty}$ be a certain Smarandache sequence such that $s(n)>0$ for any positive integer n . In [1], Russo that proposed to study the limit

$$(1) \quad L(s)=\lim_{N \rightarrow \infty} \frac{N}{\sum_{n=1}^N \text{Rev}(s(n))} .$$

In this paper we prove a general result as follows.

Theorem . Let $A=\{a(n)\}_{n=1}^{\infty}$ be a sequence of positive integers If the trailing digit of $a(n)$ is not zero for any n , then the sum of $a(n)/\text{Rev}(a(n))$ is divergent.

Proof . Let $a(n)=a_m \dots a_2 a_1$, where $a_1 \neq 0$. Then we have

$$(2) \quad \text{Rev}(a(n))=a_1 a_2 \dots a_m .$$

We see from (2) that

$$(3) \quad \frac{a(n)}{\text{Rev}(a(n))} > \frac{1}{10} .$$

Thus, by (3), the sum of $a(n)/\text{Rev}(a(n))$ is divergent . The

theorem is proved.

References

- [1] F. Russo, Some results about four Smarandache U-product sequences, Smarandache Notions J. 11(2000),42-49.

Department of Mathematics
Zhanjiang Normal College
Zhanjiang, Guangdong
P.R. CHINA

A Note On $S(n^2)$

J. Sàndor
Babes-Bolyai University, Cluj-Napoca, Romania

In the paper[1], it is shown that

$$S(n^2) \leq n \text{ for } n > 4 \text{ and even.} \quad (1)$$

In this note, we will prove that (1) holds for all $n > 4$, $n \neq \text{prime}$.

Let p be a prime. Then:

Lemma: For $n \neq p, 2p, 8$ or 9 , we have

$$n^2 \mid (n-1)! \quad (2)$$

Proof: If $n \neq p, 2p, p^2, 8$, or 16 , then n can be written as $n = xy$ ($x \neq y$; $x, y \geq 3$). If $n \neq 16$, then $n = xy$ with $x \geq 3, y \geq 5$. Let $n = xy$ with $y > x; x \geq 3$. Now $x, y, 2x, 2y, 3x < n-1$; $x, y, 2y$ are different and one of $2x, 3x$ is different from $x, y, 2y$. Therefore, $(n-1)!$ contains $x, y, 2y$ and $2x$ or $x, y, 2y$ and $3x$. In any case one has $(n-1)! \mid x^2y^2 = n^2$.

If $n = p^2$, then $n - 1 > 4p$, thus $(n-1)!$ contains the factors $p, 2p, 3p, 4p$, so $(n-1)! \mid p^4 = n^2$. For $n = 2p$, clearly p^2 does not divide $(n-1)!$. For $n = 8$ or 9 , n^2 does not divide $(n-1)!$, but for $n = 16$, this holds true by a simple verification.

As a corollary of (2), we can write

$$S(n^2) \leq n - 1 \text{ for } n \neq p, 2p, 8 \text{ or } 9 \quad (3)$$

Since $2p$ and 8 are even and $S(9^2) = 9$, on the basis of (3), (1) holds true for $n \neq p, n > 4$.

Reference:

1. J. Sàndor, *On Certain New Inequalities and Limits for the Smarandache Function*, SNJ 9(1998), No. 1-2, 63-69.

On A New Smarandache Type Function

J. Sándor
Babes-Bolyai University, 3400 Cluj-Napoca, Romania

Let $C_n^k = \binom{n}{k}$ denote a binomial coefficient, i.e.

$$C_n^k = \frac{n(n-1)\dots(n-k+1)}{1*2*\dots*k} = \frac{n!}{k!(n-k)!} \quad \text{for } 1 \leq k \leq n.$$

Clearly, $n \mid C_n^1$ and $n \mid C_n^{n-1} = C_n^1$. Let us define the following arithmetic function:

$$C(n) = \max \{ k: 1 \leq k < n-1, n \mid C_n^k \} \quad (1)$$

Clearly, this function is well-defined and $C(n) \geq 1$. We have supposed $k < n - 1$, otherwise on the basis of

$$C_n^{n-1} = C_n^1 = n, \text{ clearly we would have } C(n) = n-1.$$

By a well-known result on primes, $p \mid C_p^k$ for all primes p and $1 \leq k \leq p-1$.

Thus we get:

$$C(p) = p-2 \text{ for primes } p \geq 3. \quad (2)$$

Obviously, $C(2) = 1$ and $C(1) = 1$. We note that the above result on primes is usually used in the inductive proof of Fermat's "little" theorem.

This result can be extended as follows:

Lemma: For $(k,n) = 1$, one has $n \mid C_n^k$.

Proof: Let us remark that

$$C_n^k = \frac{n}{k} * \frac{(n-1) \dots (n-k+1)}{(k-1)!} = \frac{n}{k} * C_{n-1}^{k-1} \quad (3)$$

thus, the following identity is valid:

$$k * C_n^k = n * C_{n-1}^{k-1} \quad (3)$$

This gives $n \mid k * C_n^k$, and as $(n,k) = 1$, the result follows.

Theorem: $C(n)$ is the greatest totient of n which is less than or equal to $n - 2$.

Proof: A totient of n is a number k such that $(k,n) = 1$. From the lemma and the definition of $C(n)$, the result follows.

Remarks 1) Since $(n-2,n) = (2,n) = 1$ for odd n , the theorem implies that $C(n) = n-2$ for $n \geq 3$ and odd. Thus the real difficulty in calculating $C(n)$ is for n an even number.

2) The above lemma and Newton's binomial theorem give an extension of Fermat's divisibility theorem $p \mid (a^p - a)$ for primes p .

References

1. F. Smarandache, *A Function in the Number Theory*. Anal. Univ. Timisoara, vol. XVIII, 1980.
2. G. H. Hardy and E. M. Wright, *An Introduction to the Theory of Numbers*, Clarendon Press, Oxford, 1979.

About The $S(n) = S(n - S(n))$ Equation

Mihaly Bencze
Str. Harmanului 6, 2212 Sacele 3
Jud. Brasov, Romania

Theorem 1: (M. Bencze, 1997) There exists infinitely many $n \in \mathbb{N}$ such that $S(n) = S(n - S(n))$, where S is the Smarandache function.

Proof: Let r be a positive integer and $p > r$ a prime number. Then

$$S(pr) = S(p) = S((r-1)p) = S(pr - p) = S(pr - S(pr)).$$

Remark 1.1 There exists infinitely many $n \in \mathbb{N}$ such that

$$S(n) = S(n - S(n)) = S(n - S(n - S(n))) = \dots$$

Theorem 2: There exists infinitely many $n \in \mathbb{N}$ such that

$$S(n) = S(n + S(n)).$$

Proof:

$$S(pr) = S(p) = S((r+1)p) = S(pr+p) = S(pr + S(pr)).$$

Remark 2.1 There exists infinitely many $n \in \mathbb{N}$ such that

$$S(n) = S(n + S(n)) = S(n + S(n + S(n))) = \dots$$

Theorem 3 There exists infinitely many $n \in \mathbb{N}$ such that

$$S(n) = S(n \pm kS(n)).$$

Proof: See theorems 1 and 2.

A NOTE ON SMARANDACHE REVERSE SEQUENCE

Sam Alexander,
10888 Barbados Way,
San Diego, CA 92126.

Let $SR(n)$ be the Smarandache reverse sequence at n . To wit, the first n positive integers in reverse order, i.e.

$SR(1) = 1, SR(2) = 21, \dots, SR(12) = 121110987654321, \dots$

Then, I have found that for $n \in \mathbb{N}$,

$$SR(n) = 1 + \sum_{i=2}^n i * 10^{\sum_{j=1}^{i-1} (1 + \lfloor \log_{10} j \rfloor)}$$

where $\lfloor x \rfloor$ denotes the greatest integer not exceeding x .

“Reality is for people with
no imagination”

SMARANDACHE PASCAL DERIVED SEQUENCES

(Amarnath Murthy, S.E.(E&T), WLS, Oil and Natural Gas Corporation Ltd.,
Sabarmati, Ahmedabad,-380005 INDIA.)

Given a sequence say S_b . We call it the base sequence. We define a **Smarandache Pascal derived sequence S_d** as follows:

$$T_{n+1} = \sum_{k=0}^n {}^n C_k \cdot t_{k+1}, \text{ where } t_k \text{ is the } k^{\text{th}} \text{ term of the base sequence.}$$

Let the terms of the the base sequence S_b be

$$b_1, b_2, b_3, b_4, \dots$$

Then the Smarandache Pascal derived Sequence S_d

$d_1, d_2, d_3, d_4, \dots$ is defined as follows:

$$d_1 = b_1$$

$$d_2 = b_1 + b_2$$

$$d_3 = b_1 + 2b_2 + b_3$$

$$d_4 = b_1 + 3b_2 + 3b_3 + b_4$$

...

$$d_{n+1} = \sum_{k=0}^n {}^n C_k \cdot b_{k+1}$$

These derived sequences exhibit interesting properties for some base sequences.

Examples:

{1} $S_b \rightarrow 1, 2, 3, 4, \dots$ (natural numbers)

$S_d \rightarrow 1, 3, 8, 20, 48, 112, 256, \dots$ (Smarandache Pascal derived natural number sequence)

The same can be rewritten as

$$2 \times 2^{-1}, 3 \times 2^0, 4 \times 2^1, 5 \times 2^2, 6 \times 2^3, \dots$$

It can be verified and then proved easily that $T_n = 4(T_{n-1} - T_{n-2})$ for $n > 2$.

And also that $T_n = (n+1) \cdot 2^{n-2}$

{2} $S_b \rightarrow 1, 3, 5, 7, \dots$ (odd numbers)

$S_d \rightarrow 1, 4, 12, 32, 80, \dots$

The first difference $1, 3, 8, 20, 48, \dots$ is the same as the S_d for natural numbers.

The sequence S_d can be rewritten as

$$1 \cdot 2^0, 2 \cdot 2^1, 3 \cdot 2^2, 4 \cdot 2^3, 5 \cdot 2^4, \dots$$

Again we have $T_n = 4(T_{n-1} - T_{n-2})$ for $n > 2$. Also $T_n = n \cdot 2^{n-1}$.

{3} **Smarandache Pascal Derived Bell Sequence:**

Consider the Smarandache Factor Partitions (SFP) sequence for the square free numbers:

(The same as the **Bell number** sequence.)

$S_b \rightarrow 1, 1, 2, 5, 15, 52, 203, 877, 4140, \dots$

We get the derived sequence as follows

$S_d \rightarrow 1, 2, 5, 15, 52, 203, 877, 4140, \dots$

The **Smarandache Pascal Derived Bell Sequence** comes out to be the same. We

call it **Pascal Self Derived Sequence**. This has been established in ref. [1]
 In what follows, we shall see that this Transformation applied to Fibonacci
 Numbers gives beautiful results.

****{4} Smarandache Pascal derived Fibonacci Sequence:**

Consider the Fibonacci Sequence as the Base Sequence:

$$S_b \rightarrow 1, 1, 2, 3, 5, 8, 13, 21, 34, 55, 89, 144, 233, \dots$$

We get the following derived sequence

$$S_d \rightarrow 1, 2, 5, 13, 34, 89, 233, \dots \quad (\text{A})$$

It can be noticed that the above sequence is made of the alternate (even numbered
 terms of the sequence) Fibonacci numbers.

This gives us the following result on the Fibonacci numbers.

$$F_{2n} = \sum_{k=0}^n {}^n C_k \cdot F_k, \text{ where } F_k \text{ is the } k^{\text{th}} \text{ term of the base Fibonacci sequence.}$$

Some more interesting properties are given below.

If we take (A) as the base sequence we get the following derived sequence S_{dd}

$$S_{dd} \rightarrow 1, 3, 10, 35, 125, 450, 1625, 5875, 21250, \dots$$

An interesting observation is ,the first two terms are divisible by 5^0 , the next two
 terms by 5^1 , the next two by 5^2 , the next two by 5^3 and so on.

$$T_{2n} \equiv T_{2n-1} \equiv 0 \pmod{5^n}$$

On carrying out this division we get the following sequence i.e.

$$1, 3, 2, 7, 5, 18, 13, 47, 34, 123, 89, \dots \quad (\text{B})$$

The sequence formed by the odd numbered terms is

$$1, 2, 5, 13, 34, 89, \dots$$

which is again nothing but S_d (the base sequence itself).

Another interesting observation is every even numbered term of (B) is the sum of
 the two adjacent odd numbered terms. ($3 = 1+2$, $7 = 2 +5$, $18 = 5 + 13$ etc.)

CONJECTURE: Thus we have the possibility of another beautiful result on the
 Fibonacci numbers which of-course is yet to be established.

$$F_{2m+1} = (1/5^m) \sum_{r=0}^{2m+1} C_r \left(\sum_{k=0}^r C_k F_k \right)$$

Note: It can be verified that all the above properties hold good for the Lucas
 sequence (1 , 3 , 4 , 7 , 11 , ...) as well.

Pascalisation of Fibonacci sequence with index in arithmetic progression:

Consider the following sequence formed by the Fibonacci numbers whose indexes
 are in A. P.

$F_1, F_{d+1}, F_{2d+1}, F_{3d+1}, \dots$ on pascalisation gives the following sequence

$$1, d.F_2, d^2.F_4, d^3.F_6, d^4.F_8, \dots, d^n.F_{2n}, \dots$$

for $d = 2$ and $d = 3$.

For $d = 5$ we get the following

Base sequence : $F_1, F_6, F_{11}, F_{16}, \dots$

$$1, 13, 233, 4181, 46368, \dots$$

Derived sequence: 1, 14, 260, 4920, 93200, . . . in which we notice that
 $260 = 20 \cdot (14 - 1)$, $4920 = 20 \cdot (260 - 14)$, $93200 = 4920 - 260$) etc . which suggests
the possibility of

Conjecture: The terms of the pascal derived sequence for $d = 5$ are given by
 $T_n = 20 \cdot (T_{n-1} - T_{n-2})$ ($n > 2$)

For $d = 8$ we get

Base sequence : $F_1, F_9, F_{17}, F_{25}, \dots$

$S_b \rightarrow 1, 34, 1597, 75025, \dots$

$S_d \rightarrow 1, 35, 1666, 79919, \dots$

$= 1, 35, (35-1) \cdot 7^2, (1666 - 35) \cdot 7^2, \dots$ etc. which suggests the possibility of

Conjecture: The terms of the pascal derived sequence for $d = 8$ are given by
 $T_n = 49 \cdot (T_{n-1} - T_{n-2})$, ($n > 2$)

Similarly we have Conjectures:

For $d = 10$, $T_n = 90 \cdot (T_{n-1} - T_{n-2})$, ($n > 2$)

For $d = 12$, $T_n = 18^2 \cdot (T_{n-1} - T_{n-2})$, ($n > 2$)

Note: There seems to be a direct relation between d and the coefficient of $(T_{n-1} - T_{n-2})$ (or the common factor) of each term which is to be explored.

{5} Smarandache Pascal derived square sequence:

$S_b \rightarrow 1, 4, 9, 16, 25, \dots$

$S_d \rightarrow 1, 5, 18, 56, 160, 432, \dots$

Or $1, 5 \times 1, 6 \times 3, 7 \times 8, 8 \times 20, 9 \times 48, \dots$, ($T_n = (n+3)t_{n-1}$), where t_r is the r^{th} term of Pascal derived natural number sequence.

Also one can derive $T_n = 2^{n-2} \cdot (n+3)(n)/2$.

{6} Smarandache Pascal derived cube sequence:

$S_b \rightarrow 1, 8, 27, 64, 125$

$S_d \rightarrow 1, 9, 44, 170, 576, 1792, \dots$

We have $T_n \equiv 0 \pmod{(n+1)}$.

Similarly we have derived sequences for higher powers which can be analyzed for patterns.

{7} Smarandache Pascal derived Triangular number sequence:

$S_b \rightarrow 1, 3, 6, 10, 15, 21, \dots$

$S_d \rightarrow 1, 4, 13, 38, 104, 272, \dots$

{8} Smarandache Pascal derived Factorial sequence:

$S_b \rightarrow 1, 2, 6, 24, 120, 720, 5040, \dots$

$S_d \rightarrow 1, 3, 11, 49, 261, 1631, \dots$

We can verify that $T_n = n \cdot T_{n-1} + \sum T_{n-2} + 1$.

Problem: Are there infinitely many primes in the above sequence?

Smarandache Pascal derived sequence of the k^{th} order.

Consider the natural number sequence again:

$S_b \rightarrow 1, 2, 3, 4, 5, \dots$ The corresponding derived sequence is

$S_d \rightarrow 2 \times 2^1, 3 \times 2^0, 4 \times 2^1, 5 \times 2^2, 6 \times 2^3, \dots$ With this as the base sequence we get the derived sequence denoted by S_{d2} as

S_{d2} or $S_{d2} \rightarrow 1, 4, 15, 54, 189, 648, \dots$ which can be rewritten as

$1, 4 \times 3^0, 5 \times 3^1, 6 \times 3^2, 7 \times 3^3 \dots$

similarly we get S_{d3} as $1, 5 \times 4^0, 6 \times 4^1, 7 \times 4^2, 8 \times 4^3, \dots$ which suggests the

possibility of the terms of S_{dk} , the k^{th} order Smarandache Pascal derived natural

number sequence being given by

$1, (k+2) \cdot (k+1)^0, (k+3) \cdot (k+1)^1, (k+4) \cdot (k+1)^2, \dots, (k+r) \cdot (k+1)^{r-2}$ etc. This can be proved by induction.

We can take an arithmetic progression with the first term 'a' and the common difference 'b' as the base sequence and get the derived k^{th} order sequences to generalize the above results.

Reference:[1] Amarnath Murthy, 'Generalization of Partition Function,. Introducing Smarandache Factor Partitions' SNJ, Vol. 11, No. 1-2-3,2000.

**DEPASCALISATION OF SMARANDACHE PASCAL DERIVED SEQUENCES
AND BACKWARD EXTENDED FIBONACCI SEQUENCE**

Amarnath Murthy, S.E.(E&T) , WLS, Oil and Natural Gas Corporation Ltd., Sabarmati,
Ahmedabad,- 380005 INDIA.

Given a sequence S_b (called the base sequence).

$$b_1, b_2, b_3, b_4, \dots$$

Then the Smarandache Pascal derived Sequence S_d

$d_1, d_2, d_3, d_4, \dots$ is defined as follows: **Ref [1]**

$$d_1 = b_1$$

$$d_2 = b_1 + b_2$$

$$d_3 = b_1 + 2b_2 + b_3$$

$$d_4 = b_1 + 3b_2 + 3b_3 + b_4$$

...

$$d_{n+1} = \sum_{k=0}^n {}^n C_k \cdot b_{k+1}$$

Now Given S_d the task ahead is to find out the base sequence S_b . We call the process of extracting the base sequence from the Pascal derived sequence as **Depascalisation**. The interesting observation is that this again involves the Pascal's triangle though with a difference.

We see that

$$b_1 = d_1$$

$$b_2 = -d_1 + d_2$$

$$b_3 = d_1 - 2d_2 + d_3$$

$$b_4 = -d_1 + 3d_2 - 3d_3 + d_4$$

...

which suggests the possibility of

$$b_{n+1} = \sum_{k=0}^n (-1)^{n+k} \cdot {}^n C_k \cdot d_{k+1}$$

This can be established by induction.

We shall see that the depascalised sequences also exhibit interesting patterns.

To begin with we define The **Backward Extended Fibonacci Sequence (BEFS)** as Follows:

The Fibonacci sequence is

1, 1, 2, 3, 5, 8, 13, 21, 34, 55, 89, 144, 233, ...

In which $T_1 = 1$, $T_2 = 1$, and $T_{n-2} = T_n - T_{n-1}$, $n > 2$ (A)

Now If we allow n to take values $0, -1, -2, \dots$ also, we get

$T_0 = T_2 - T_1 = 0$, $T_{-1} = T_1 - T_0 = 1$, $T_{-2} = T_0 - T_{-1} = -1$, etc. and we get the Fibonacci sequence extended backwards as follows { T_r is the r^{th} term }

... T_{-6} , T_{-5} , T_{-4} , T_{-3} , T_{-2} , T_{-1} , T_0 , T_1 , T_2 , T_3 , T_4 , T_5 , T_6 , T_7 , T_8 , T_9 , ...

... -8, 5, -3, 2, -1, 1, 0, 1, 1, 2, 3, 5, 8, 13, 21, 34, ...

1. Depascalisation of the Fibonacci sequence:

The Fibonacci sequence is

1, 1, 2, 3, 5, 8, 13, 21, 34, 55, 89, 144, 233, ...

The corresponding depascalised sequence $S_{d(-1)}$ comes out to be

$S_{d(-1)} \rightarrow 1, 0, 1, -1, 2, -3, 5, -8, \dots$

It can be noticed that, The resulting sequence is nothing but the **BEFS** rotated by 180° about T_1 . and then the terms to the left of T_1 omitted. { This has been generalised in the Proposition 2 below. }

It is not over here. If we further depascalise the above sequence we get the following sequence $S_{d(-2)}$ as

1, -1, 2, -5, 13, -34, 89, -233

This can be obtained alternately from the Fibonacci Sequence by:

- (a) Removing even numbered terms.
- (b) Multiplying alternate terms with (-1) in the thus obtained sequence.

Propositions:

Following two propositions are conjectured on Pascalisation and Depascalisation of Fibonacci Sequence.

(1) If the first r terms of the Fibonacci Sequence are removed and the remaining sequence is Pascalised, the resulting Derived Sequence is $F_{2r+2}, F_{2r+4}, F_{2r+6}, F_{2r+8}, \dots$ where F_r is the r^{th} term of the Fibonacci Sequence.

(2) In the FEBS If we take T_r as the first term and Depascalise the Right side of it then we get the resulting sequence as the left side of it (looking rightwards) with T_r as the first term.

As an example let $r = 7, T_7 = 13$

$\dots T_{-6} T_{-5} T_{-4} T_{-3} T_{-2} T_{-1} T_0 T_1 T_2 T_3 T_4 T_5 T_6 \underline{T_7} T_8 T_9 \dots$
 $\dots -8, 5, -3, 2, -1, 1, 0, 1, 1, 2, 3, 5, 8, \underline{13}, 21, 34, 55, 89, \dots$

→→→→→→→→→→

depascalisation

The Depascalised sequence is

13, 8, 5, 3, 2, 1, 1, 0, 1, -1, 2, -3, 5, -8 . . .

which is obtained by rotating the FEBS around 13 (T_7) by 180° and then removing the terms on the left side of 13.

One can explore for more fascinating results.

References:

[1] "Amarnath Murthy", 'Smarandache Pascal derived Sequences', SNJ, 2000.

PROOF OF THE DEPASCALISATION THEOREM

Amarnath Murthy, S.E.(E&T), WLS, Oil and Natural Gas Corporation Ltd.,
Sabarmati, Ahmedabad,-380005 INDIA.

In [1] we have defined Pascalisation as follows:

Let b_1, b_2, \dots be a base sequence. Then the **Smarandache Pascal derived sequence**

d_1, d_2, \dots is defined as

$$d_1 = b_1$$

$$d_2 = b_1 + b_2$$

$$d_3 = b_1 + 2b_2 + b_3$$

$$d_4 = b_1 + 3b_2 + 3b_3 + b_4$$

...

$$d_{n+1} = \sum_{k=0}^n {}^n C_k \cdot b_{k+1}$$

Now Given S_d the task ahead is to find out the base sequence S_b . We call the process of extracting the base sequence from the Pascal derived sequence as **Depascalisation**. The interesting observation is that this again involves the Pascal's triangle, but with a difference.

On expressing b_k 's in terms of d_k 's We get

$$b_1 = d_1$$

$$b_2 = -d_1 + d_2$$

$$b_3 = d_1 - 2d_2 + d_3$$

$$b_4 = -d_1 + 3d_2 - 3d_3 + d_4$$

...

which suggests the possibility of

$$b_{n+1} = \sum_{k=0}^n (-1)^{n+k} \cdot {}^n C_k \cdot d_{k+1}$$

This I call as Depascalisation Theorem.

PROOF: We shall prove it by induction.

Let the proposition be true for all the numbers $l \leq k+1$. Then we have

$$b_{k+1} = {}^k C_0 (-1)^{k+2} d_1 + {}^k C_1 (-1)^{k+1} d_2 + \dots + {}^k C_k (-1)^2$$

Also we have

$$d_{k+2} = {}^{k+1} C_0 b_1 + {}^{k+1} C_1 b_2 + \dots + {}^{k+1} C_r b_{r+1} + \dots + {}^{k+1} C_{k+1} b_{k+2}, \text{ which gives}$$

$$b_{k+2} = (-1)^{k+1} {}^{k+1} C_0 b_1 - {}^{k+1} C_1 b_2 - \dots - {}^{k+1} C_r b_{r+1} - \dots + d_{k+2}$$

substituting the values of b_1, b_2, \dots etc. in terms of d_1, d_2, \dots , we get the

coefficient of d_1 as

$$(-1)^{k+1} {}^{k+1} C_0 + (-1)^{k+1} {}^{k+1} C_1 (-1) {}^k C_0 + (-1)^{k+1} {}^{k+1} C_2 ({}^2 C_0) + \dots + (-1)^r \cdot {}^{k+1} C_r ({}^r C_0) + \dots + (-1)$$

$${}^{k+1} C_k ({}^k C_0)$$

$$- {}^{k+1} C_0 + {}^{k+1} C_1 \cdot {}^1 C_0 - {}^{k+1} C_2 \cdot {}^2 C_0 + \dots + (-1)^r \cdot {}^{k+1} C_r \cdot {}^r C_0 + \dots + (-1)^{k+1} \cdot {}^{k+1} C_k \cdot {}^k C_0$$

similarly the coefficient of d_2 is

$${}^{k+1} C_1 \cdot {}^1 C_1 + {}^{k+1} C_2 \cdot {}^2 C_1 + \dots + (-1)^{r+1} \cdot {}^{k+1} C_r \cdot {}^r C_1 + \dots + (-1)^{k+1} \cdot {}^{k+1} C_k \cdot {}^k C_1$$

on similar lines we get the coefficient of d_{m+1} as

$$\begin{aligned}
& {}^{k+1}C_m \cdot {}^mC_m + {}^{k+1}C_{m+1} \cdot {}^{m+1}C_m - \dots + (-1)^{r+m} \cdot {}^{k+1}C_{r+m} \cdot {}^{r+m}C_m + \dots + (-1)^{k+m} \cdot {}^{k+1}C_k \cdot {}^kC_m \\
= & \sum_{h=0}^{k-m} (-1)^{h+1} {}^{k+1}C_{m+h} \cdot {}^{m+h}C_m
\end{aligned}$$

$$\sum_{h=0}^{(k+1)-m} (-1)^{h+1} {}^{k+1}C_{m+h} \cdot {}^{m+h}C_m \quad \therefore \quad (-1)^{k+m} \cdot {}^{k+1}C_{k+1} \cdot {}^{k+1}C_m \quad (1)$$

Applying theorem {4.2} of reference [2], in (1) we get

$$\begin{aligned}
& = {}^{k+1}C_m \{ 1 + (-1) \}^{k+1-m} + (-1)^{k+m} \cdot {}^{k+1}C_m \\
& = (-1)^{k+m} \cdot {}^{k+1}C_m
\end{aligned}$$

which shows that the proposition is true for (k+2) as well. The proposition has already been verified for k+1 = 3, hence by induction the proof is complete.

In matrix notation if we write

$$[b_1, b_2, \dots, b_n]_{1 \times n} * [p_{ij}]'_{n \times n} = [d_1, d_2, \dots, d_n]_{1 \times n}$$

where $[p_{ij}]'_{n \times n}$ = the transpose of $[p_{ij}]_{n \times n}$ and

$$[p_{ij}]_{n \times n} \text{ is given by } p_{ij} = {}^{i-1}C_{j-1} \text{ if } i \leq j \quad \text{else } p_{ij} = 0$$

Then we get the following result

If $[q_{ij}]_{n \times n}$ is the transpose of the inverse of $[p_{ij}]_{n \times n}$ Then

$$q_{ij} = (-1)^{j+i} \cdot {}^{i-1}C_{j-1}$$

We also have

$$[b_1, b_2, \dots, b_n] * [q_{ij}]'_{n \times n} = [d_1, d_2, \dots, d_n]$$

where $[q_{ij}]'_{n \times n}$ = The Transpose of $[q_{ij}]_{n \times n}$

References:

- [1] Amarnath Murthy, ' Smarandache Pascal Derived Sequences', SNJ, March ,2000.
- [2] Amarnath Murthy, 'More Results and Applications of the Smarandache Star Function., SNJ, VOL.11, No. 1-2-3, 2000.

On Certain Arithmetic Functions

József Sándor

Babeş-Bolyai University, 3400 Cluj-Napoca, Romania

In the recent book [1] there appear certain arithmetic functions which are similar to the Smarandache function. In a recent paper [2] we have considered certain generalization or duals of the Smarandache function $S(n)$. In this note we wish to point out that the arithmetic functions introduced in [1] all are particular cases of our function F_f , defined in the following manner (see [2] or [3]).

Let $f : \mathbb{N}^* \rightarrow \mathbb{N}^*$ be an arithmetical function which satisfies the following property:

(P_1) For each $n \in \mathbb{N}^*$ there exists at least a $k \in \mathbb{N}^*$ such that $n|f(k)$.

Let $F_f : \mathbb{N}^* \rightarrow \mathbb{N}^*$ defined by

$$F_f(n) = \min\{k \in \mathbb{N}^* : n|f(k)\} \quad (1)$$

In Problem 6 of [1] it is defined the "ceil function of t -th order" by $S_t(n) = \min\{k : n|k^t\}$. Clearly here one can select $f(m) = m^t$ ($m = 1, 2, \dots$), where $t \geq 1$ is fixed. Property (P_1) is satisfied with $k = n^t$. For $f(m) = \frac{m(m+1)}{2}$, one obtains the "Pseudo-Smarandache" function of Problem 7. The Smarandache "double-factorial" function

$$SDF(n) = \min\{k : n|k!!\}$$

where

$$k!! = \begin{cases} 1 \cdot 3 \cdot 5 \dots k & \text{if } k \text{ is odd} \\ 2 \cdot 2 \cdot 6 \dots k & \text{if } k \text{ is even} \end{cases}$$

of Problem 9 [1] is the particular case $f(m) = m!!$. The "power function" of Definition 24,

i.e. $SP(n) = \min\{k : n|k^k\}$ is the case of $f(k) = k^k$. We note that the Definitions 39 and 40 give the particular case of S_t for $t = 2$ and $t = 3$.

In our paper we have introduced also the following "dual" of F_f . Let $g : \mathbb{N}^* \rightarrow \mathbb{N}^*$ be a given arithmetical function, which satisfies the following assumption:

(P_3) For each $n \geq 1$ there exists $k \geq 1$ such that $g(k)|n$.

Let $G_g : \mathbb{N}^* \rightarrow \mathbb{N}^*$ defined by

$$G_g(n) = \max\{k \in \mathbb{N}^* : g(k)|n\}. \quad (2)$$

Since $k^t|n$, $k!!|n$, $k^k|n$, $\frac{k(k+1)}{2}|n$ all are verified for $k = 1$, property (P_3) is satisfied, so we can define the following duals of the above considered functions:

$$S_t^*(n) = \max\{k : k^t|n\};$$

$$SDF^*(n) = \max\{k : k!!|n\};$$

$$SP^*(n) = \max\{k : k^k|n\};$$

$$Z^*(n) = \max\left\{k : \frac{k(k+1)}{2}|n\right\}.$$

These functions are particular cases of (2), and they could deserve a further study, as well.

References

- [1] F. Smarandache, *Definitions, solved and unsolved problems, conjectures, and theorems in number theory and geometry*, edited by M.L. Perez, Xiquan Publ. House (USA), 2000.
- [2] J. Sándor, *On certain generalization of the Smarandache function*, Notes Number Theory Discrete Mathematics, **5**(1999), No.2, 41-51.
- [3] J. Sándor, *On certain generalizations of the Smarandache function*. Smarandache Notions Journal. **11**(2000). No.1-2-3, 202-212.

SMARANDACHE STAR (STIRLING) DERIVED SEQUENCES

Amarnath Murthy, S.E.(E&T), WLS, Oil and Natural Gas Corporation Ltd.,
Sabarmati, Ahmedabad,-380005 INDIA.

Let b_1, b_2, b_3, \dots be a sequence say S_b the base sequence. Then the Smarandache star derived sequence S_d using the following star triangle {ref. [1]} is defined

$$\begin{array}{cccccc}
 1 & & & & & \\
 1 & 1 & & & & \\
 1 & 3 & 1 & & & \\
 1 & 7 & 6 & 1 & & \\
 1 & 15 & 25 & 10 & 1 & \\
 \dots & & & & &
 \end{array}$$

as follows

$$d_1 = b_1$$

$$d_2 = b_1 + b_2$$

$$d_3 = b_1 + 3b_2 + b_3$$

$$d_4 = b_1 + 7b_2 + 6b_3 + b_4$$

...

$$d_{n+1} = \sum_{k=0}^n a_{(m,r)} \cdot b_{k+1}$$

where $a_{(m,r)}$ is given by

$$a_{(m,r)} = (1/r!) \sum_{t=0}^r (-1)^{r-t} \cdot {}^r C_t \cdot t^m, \text{ Ref. [1]}$$

e.g. (1) If the base sequence S_b is 1, 1, 1, ... then the derived sequence S_d is 1, 2, 5, 15, 52, ..., i.e. the sequence of Bell numbers. $T_n = B_n$

(2) $S_b \rightarrow 1, 2, 3, 4, \dots$ then

$S_d \rightarrow 1, 3, 10, 37, \dots$, we have $T_n = B_{n+1} - B_n$. Ref [1]

The Significance of the above transformation will be clear when we consider the inverse transformation. It is evident that the star triangle is nothing but the **Stirling Numbers of the Second kind (Ref. [2])**. Consider the inverse Transformation : Given the Smarandache Star Derived Sequence S_d , to retrieve the original base sequence S_b . We get b_k for $k = 1, 2, 3, 4$ etc. as follows ;

$$b_1 = d_1$$

$$b_2 = -d_1 + d_2$$

$$b_3 = 2d_1 - 3d_2 + d_3$$

$$b_4 = -6d_1 + 11d_2 - 6d_3 + d_4$$

$$b_5 = 24d_1 - 50d_2 + 35d_3 - 10d_4 + d_5$$

.....

we notice that the triangle of coefficients is

$$\begin{array}{cc}
 1 & \\
 -1 & 1
 \end{array}$$

2 -3 1
 -6 11 -6 1
 24 -50 35 -10 1

Which are nothing but the **Stirling numbers of the first kind**.

Some of the properties are

- (1) The first column numbers are $(-1)^{r-1} \cdot (r-1)!$, where r is the row number.
2. Sum of the numbers of each row is zero.
3. Sum of the absolute values of the terms in the r^{th} row = $r!$.

More properties can be found in Ref. [2].

This provides us with a relationship between the Stirling numbers of the first kind and that of the second kind, which can be better expressed in the form of a matrix.

Let $[b_{1,k}]_{1 \times n}$ be the row matrix of the base sequence.

$[d_{1,k}]_{1 \times n}$ be the row matrix of the derived sequence.

$[S_{j,k}]_{n \times n}$ be a square matrix of order n in which $s_{j,k}$ is the k^{th} number in the j^{th} row of the star triangle (array of the **Stirling numbers of the second kind** , Ref. [2]).

Then we have

$[T_{j,k}]_{n \times n}$ be a square matrix of order n in which $t_{j,k}$ is the k^{th} number in the j^{th} row of the array of the **Stirling numbers of the first kind** , Ref. [2]). Then we have

$$[b_{1,k}]_{1 \times n} * [S_{j,k}]'_{n \times n} = [d_{1,k}]_{1 \times n}$$

$$[d_{1,k}]_{1 \times n} * [T_{j,k}]'_{n \times n} = [b_{1,k}]_{1 \times n}$$

Which suggests that $[T_{j,k}]'_{n \times n}$ is the transpose of the inverse of the transpose of the Matrix $[S_{j,k}]'_{n \times n}$.

The proof of the above proposition is inherent in theorem 10.1 of ref. [3].

Readers can try proofs by a combinatorial approach or otherwise.

REFERENCES:

- [1] "Amarnath Murthy", 'Properties of the Smarandache Star Triangle' , SNJ, Vol. 11, No. 1-2-3, 2000.
- [2] "V. Krishnamurthy" , 'COMBINATORICS Theory and applications' ,East West Press Private Limited, 1985.
- [3] " Amarnath Murthy", 'Miscellaneous results and theorems on Smarandache Factor Partitions.', SNJ,Vol. 11,No. 1-2-3, 2000.

SMARANDACHE FRIENDLY NUMBERS AND A FEW MORE SEQUENCES

(Amarnath Murthy, S.E.(E&T) , WLS, Oil and Natural Gas Corporation Ltd., Sabarmati,
Ahmedabad,- 380005 INDIA.)

If the sum of any set of consecutive terms of a sequence = the product of the first and the last number of the set then this pair is called a **Smarndache Friendly Pair** with respect to the sequence.

{1} SMARANDACHE FRIENDLY NATURAL NUMBER PAIRS:

e.g. Consider the natural number sequence

1, 2, 3, 4, 5, 6, 7, ...

then the Smarandache friendly pairs are

(1,1), (3, 6) , (15,35) , (85, 204), ... etc.

as $3 + 4 + 5 + 6 = 18 = 3 \times 6$

$15 + 16 + 17 + \dots + 33 + 34 + 35 = 525 = 15 \times 35$ etc.

There exist infinitely many such pairs. This is evident from the fact that if (m, n) is a friendly pair then so is the pair (2n+m, 5n +2m -1). Ref [1].

{2} SMARANDACHE FRIENDLY PRIME PAIRS:

Consider the prime number sequence

2, 3, 5, 7, 11, 13, 17, 23, 29, ...

we have $2 + 3 + 5 = 10 = 2 \times 5$, Hence (2, 5) is a friendly prime pair.

$3 + 5 + 7 + 11 + 13 = 39 = 3 \times 13$, (3,13) is a friendly prime pair.

$5 + 7 + 11 + \dots + 23 + 29 + 31 = 155 = 5 \times 31$, (5, 31) is a friendly prime pair.

Similarly (7, 53) is also a Smarandache friendly prime pair. In a friendly prime pair (p, q) we define q as the big brother of p.

Open Problems: (1) Are there infinitely many friendly prime pairs?

2. Are there big brothers for every prime?

{3} SMARANDACHE UNDER-FRIENDLY PAIR:

If the sum of any set of consecutive terms of a sequence is a **divisor** of the product of the first and the last number of the set then this pair is called a **Smarndache under- Friendly Pair** with respect to the sequence.

{4} SMARANDACHE OVER-FRIENDLY PAIR:

If the sum of any set of consecutive terms of a sequence is a **multiple** of the product of the first and the last number of the set then this pair is called a **Smarndache Over- Friendly Pair** with respect to the sequence.

{5} SMARANDACHE SIGMA DIVISOR PRIME SEQUENCE:

The sequence of primes p_n , which satisfy the following congruence.

$n-1$

$$\sum_{r=1}^{n-1} p_r \equiv 0 \pmod{p_n}$$

$r=1$

2, 5, 71, ...

5 divides 10, and 71 divides $568 = 2 + 3 + 5 + \dots + 67$

Problems: (1) Is the above sequence infinite?

Conjecture: Every prime divides at least one such cumulative sum.

{6} SMARANDACHE SMALLEST NUMBER WITH 'n' DIVISORS SEQUENCE:

1, 2, 4, 6, 16, 12, 64, 24, 36, 48, 1024, ...

$d(1) = 1, d(2) = 2, d(4) = 3, d(6) = 4, d(16) = 5, d(12) = 6$ etc. , $d(T_n) = n$, where T_n is **smallest such number**.

It is evident $T_p = 2^{p-1}$, if p is a prime.

The sequence T_n+1 is

2, 3, 5, 7, 17, 13, 65, 25, 37, 49, 1025, ...

Conjectures: (1) The above sequence contains infinitely many primes.

(2) The only Mersenne's prime it contains is 7.

(3) The above sequence contains infinitely many perfect squares.

{7} SMARANDACHE INTEGER PART k^n SEQUENCE (SIPS) :

****In this sequence k is a non integer. For example:**

(i) SMARANDACHE INTEGER PART π^n SEQUENCE:

$[\pi^1], [\pi^2], [\pi^3], [\pi^4], \dots$

3, 9, 31, 97, ...

(ii) SMARANDACHE INTEGER PART e^n SEQUENCE:

$[e^1], [e^2], [e^3], [e^4], \dots$

2, 7, 20, 54, 148, 403, ...

Conjecture: Every SIPS contains infinitely many primes.

{8} Smarandache Summable Divisor Pairs (SSDP):

Pair of numbers (m, n) which satisfy the following relation

$$d(m) + d(n) = d(m + n)$$

e.g. we have $d(2) + d(10) = d(12)$, $d(3) + d(5) = d(8)$, $d(4) + d(256) = d(260)$,

$d(8) + d(22) = d(30)$, etc.

hence $(2, 10)$, $(3, 5)$, $(4, 256)$, $(8, 22)$ are SSPDs.

Conjecture: (1) There are infinitely many SSDPs?

(2) For every integer m there exists a number n such that (m, n) is an SSDP.

{9} SMARANDACHE REIMANN ZETA SEQUENCE

6, 90, 945, 93555, 638512875, ...

where T_n is given by the following relation of

$$z(s) = \sum_{n=1}^{\infty} n^{-s} = \pi^{2n} / T_n$$

Conjecture: No two terms of this sequence are relatively prime.

Consider the sequence obtained by incrementing each term by one

7, 91, 946, 9451, 93556, 638512876, ...

Problem: How many primes does the above sequence contain?

{10} SMARANDACHE PRODUCT OF DIGITS SEQUENCE:

The n^{th} term of this sequence is defined as $T_n =$ product of the digits of n .

1, 2, 3, 4, 5, 6, 7, 8, 9, 0, 1, 2, 3, 4, 5, 6, 7, 8, 9, 0, 2, 4, 6, 8, 10, 12, ...

{11} SMARANDACHE SIGMA PRODUCT OF DIGITS NATURAL SEQUENCE:

The n^{th} term of this sequence is defined as the sum of the products of all the numbers from 1 to n .

1, 3, 6, 10, 15, 21, 28, 36, 45, 45, 46, 48, 51, 55, 60, 66, 73, 81, 90, 90, 92, 96, ...

Here we consider the terms of the sequence for some values of n .

For $n = 9$ we have $T_n = 45$, The sum of all the single digit numbers = 45

For $n = 99$ we have $T_n = 2070 = 45^2 + 45..$

Similarly we have $T_{999} = (T_9)^3 + (T_9)^2 + T_9 = 45^3 + 45^2 + 45 = (45^4 - 1) / (45 - 1) = (45^4 - 1) / 44$

The above proposition can easily be proved.

This can be further generalized for a number system with base 'b' ($b = 10$, the decimal system has already been considered.)

For a number system with base 'b' the $(b^r - 1)^{\text{th}}$ term in the Smarandache sigma product of digits sequence is

$$2\{ \{ b(b-1)/2 \}^{r+1} - 1 \} / \{ b^2 - b - 2 \}$$

Further Scope: The task ahead is to find the n^{th} term in the above sequence for an arbitrary value of n .

{12} SMARANDACHE SIGMA PRODUCT OF DIGITS ODD SEQUENCE:

1, 4, 9, 16, 25, 26, 29, 34, 41, 50, 52, 58, 68, 82, 100, 103, 112, 127, 148, ...

It can be proved that for $n = 10^r - 1$, T_n is the sum of the r terms of the Geometric progression with the first term as 25 and the common ratio as 45.

{13} SMARANDACHE SIGMA PRODUCT OF DIGITS EVEN SEQUENCE:

2, 6, 12, 20, 20, 22, 26, 32, 40, 40, 44, 52, 62, 78, 78, 84, 96, 114, 138, ...

It can again be proved that for $n = 10^r - 1$, T_n is the sum of the r terms of the Geometric progression with the first term as 20 and the common ratio as 45.

Open Problem: Are there infinitely many common members in {12} and {13} ?

Reference:

[1] Problem2/31, M&IQ ,3/99 Volume 9, Sept' 99, Bulgaria.

SMARANDACHE GEOMETRICAL PARTITIONS AND SEQUENCES

Amarnath Murthy, S.E.(E&T) , WLS, Oil and Natural Gas Corporation Ltd., Sabarmati,
Ahmedabad,- 380005 INDIA.

{1} Smarandache Traceable Geometrical Partition

Consider a chain having identical links (sticks) which can be bent at the hinges to give it different shapes.

Consider the following shapes (Annexure-I) obtained with chains having one , two , three or more number of links.

(Annexure-I)

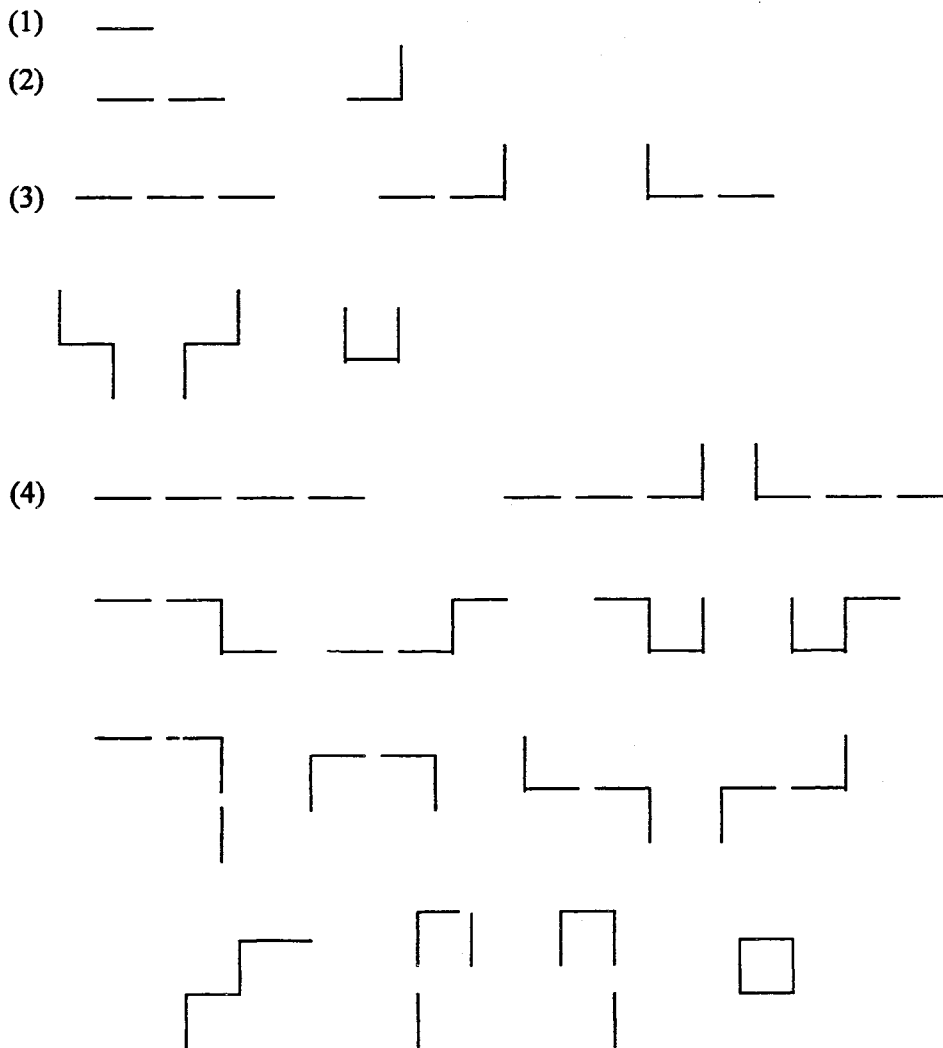

We notice that the shapes of the figures drawn satisfy the following rules:

1. The links are either horizontal or vertical.
2. No figure could be obtained by the other by rotation without lifting it from the horizontal plane.
3. As the links are connected, there are only two ends and one can travel from one end to the other traversing all the links. There are at the most two ends (there can be zero ends in case of a closed figure) to each figure. These are the nodes which are connected to only one link.

Number of such partitions we define as **Smarandache Traceable Geometric Partition** function **STGP** denoted by $S_{gp}(n)$. The sequence thus obtained is called **Smarandache Traceable Geometric Partition Sequence (STGPS)**.

1, 2, 6, 15, ...

Open Problem

(1): To Derive a reduction formula for the above sequence.

BEND:

We define a **bend** as a point at which the angle between the two terminating sticks is 90°

Given below is the chart of number of partitions with various bends for 1,2, 3, 4 etc. sticks .

No of bends →	0	1	2	3	4
No of sticks ↓					
1	1	0	0	0	0
2	1	1	0	0	0
3	1	2	3	0	0
4	1	3	7	3	1

By extending this table for more number of sticks one can look for patterns.

{2} Smarandache Comprehensive Geometric Partition:

Consider a set of identical sticks (separate links of the chain in {1}) . If we also include the figures in which

- (a) There are more than two ends.
- (b) One may not be able travel from one end covering all the sticks without traversing at least one stick more than once.

in {1} then we get the following partitions. **Annexure -II.**

We call it **Smarandache Comprehensive Geometric Partition Function(SCGP)** and the sequence thus obtained **SCGPS**.

SCGPS \longrightarrow 1, 2, 7, 25...

In the above if we count number of partitions having two , three, four ends etc. separately we get the following chart

No of sticks \rightarrow	1	2	3	4
No of ends \downarrow				
0	0	0	0	1
1	0	0	0	0
2	1	2	6	14
3	0	0	1	9
4	0	0	0	1

This table can be extended for more number of sticks and the task ahead is to find patterns if any and their inter-relations.

Open Problem (2) To Derive a reduction formula for SCGPS.

Further Scope: This idea of Geometric partitions can be **generalized** for other angle of bends e.g. for 60° placement of the sticks/chain links.

Annexure -II.

(1) —

(2) — —

└

Total = 2

(3) — — —

— └

└ —

Total = 7

└ └

└ └

└

└

(4) — — — —

— — — └

└ — — —

— └

— └

└ └

└ └

— └

└ └

└ └

└ └

└ └

└

└

□

└

└

└

└

└ —

+

└ —

— └

└

└

Total = 25

SMARANDACHE ROUTE SEQUENCES

Amarnath Murthy, S.E.(E&T) , WLS, Oil and Natural Gas Corporation Ltd., Sabarmati,
Ahmedabad,- 380005 INDIA.

Consider a rectangular city with a mesh of tracks which are of equal length and which are either horizontal or vertical and meeting at nodes. If one row contains m tracks and one column contains n tracks then there are $(m+1)(n+1)$ nodes. To begin with let the city be of a square shape i.e. $m = n$.

Consider the possible number of routes R which a person at one end of the city can take from a source S (starting point) to reach the diagonally opposite end D the destination.

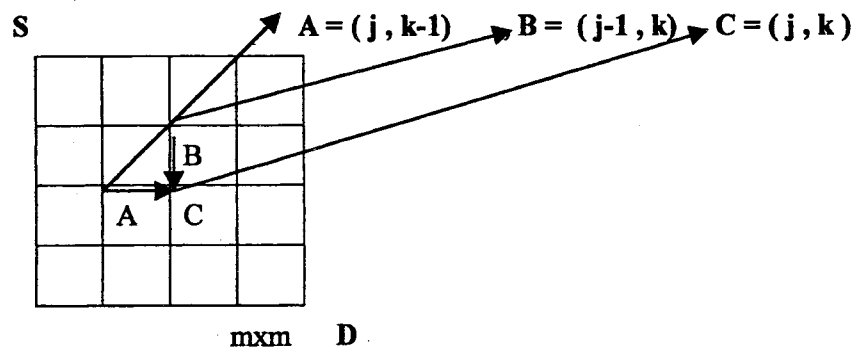

(m rows and m columns)

Refer Figure -I

For $m = 1$ Number of routes $R = 1$

For $m = 2$, $R = 2$

For $m = 3$, $R = 12$

We see that for the shortest routes one has to travel $2m$ units of track length. There are routes with $2m + 2$ units up to the longest route being $4m + 4$.

We define **Smarandache Route Sequence (SRS)** as the number of all possible routes for a ' m ' square city. This includes routes with path lengths ranging from $2m$ to $4m + 4$.

Open problem(1): To derive a reduction formula/ general formula for SRS.

Here we derive a reduction formula, thus a general formula for the number of **shortest routes**.

Reduction formula for number of shortest routes:

Refer figure -II

Let $R_{j,k}$ = number of routes to reach node (j, k) .

Node (j , k). Can be reached only either from node (j-1, k) or from the node (j , k-1) . * {As only shortest routes are to be considered }.

It is clear that there is only one way of reaching node (j , k) from node (j-1 , k). Similarly there is only one way of reaching node (j , k) from node (j , k-1). Hence the number of shortest routes to node (j , k) is given by

$$R_{j,k} = 1. R_{j-1,k} + 1. R_{j,k-1} = R_{j-1,k} + R_{j,k-1}$$

This gives the reduction formula for $R_{j,k}$.

Applying this reduction formula to fill the chart we observe that the total number of shortest routes to the destination (the other end of the diagonal) is 2nC_n . This can be established by induction .

We can further categorize the routes by the number of **turning points** it is subjected to.

The chart for various number of turning points(TPs) for a city with 9 nodes is given below.

No of TPs	1	2	3	4
No of routes	2	2	2	5

Further Scope:

(1) To explore for patterns among total number of routes , number of turning points and develop formulae for square as well as rectangular meshes (cities).

(2) To study as to how many routes pass through a given number/set of nodes? How many of them pass through all the nodes?

Figure-I

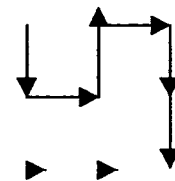
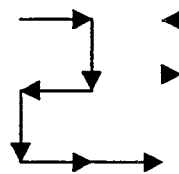
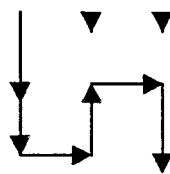
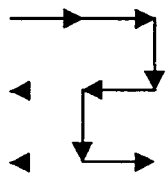
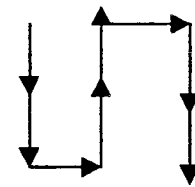
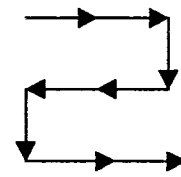
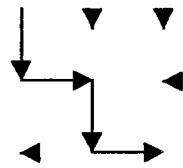
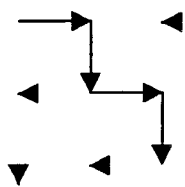
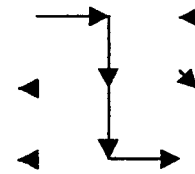
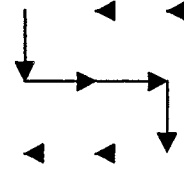
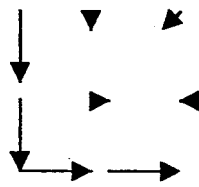
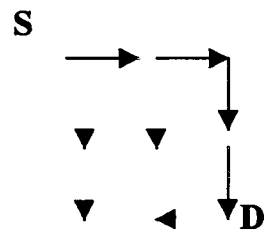
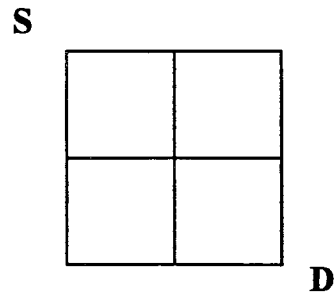
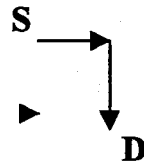
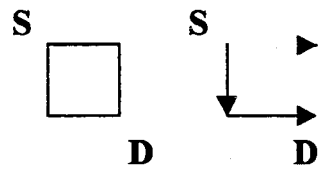

SMARANDACHE DETERMINANT SEQUENCES

Amarnath Murthy, S.E.(E&T) , WLS, Oil and Natural Gas Corporation Ltd.,
Sabarmati, Ahmedabad,- 380005 INDIA.

In this note two types of Smarandache type determinant sequences are defined and studied.

(1) Smarandache Cyclic Determinant Sequences:

(a) Smarandache Cyclic Determinant Natural Sequence:

$$\begin{vmatrix} 1 \end{vmatrix}, \begin{vmatrix} 1 & 2 \\ 2 & 1 \end{vmatrix}, \begin{vmatrix} 1 & 2 & 3 \\ 2 & 3 & 1 \\ 3 & 1 & 2 \end{vmatrix}, \begin{vmatrix} 1 & 2 & 3 & 4 \\ 2 & 3 & 4 & 1 \\ 3 & 4 & 1 & 2 \\ 4 & 1 & 2 & 3 \end{vmatrix}, \dots$$

$$1, -3, -18, \dots, 160, \dots$$

This suggests the possibility of the n^{th} term as

$$T_n = (-1)^{[n/2]} \{(n+1)/2\} \cdot n^{n-1} \quad \text{--- (A)}$$

Where $[]$ stands for integer part

We verify this for $n = 5$, and the general case can be dealt with on similar lines.

$$T_5 = \begin{vmatrix} 1 & 2 & 3 & 4 & 5 \\ 2 & 3 & 4 & 5 & 1 \\ 3 & 4 & 5 & 1 & 2 \\ 4 & 5 & 1 & 2 & 3 \\ 5 & 1 & 2 & 3 & 4 \end{vmatrix}$$

on carrying out following elementary operations

(a) $R_1 =$ sum of all the rows, (b) taking 15 common from the first row

(c) Replacing C_k the k^{th} column by $C_k - C_1$, we get

$$T_5 = 15 \begin{vmatrix} 1 & 0 & 0 & 0 & 0 \\ 2 & 1 & 2 & 3 & -1 \\ 3 & 1 & 2 & -2 & -1 \\ 4 & 1 & -3 & -2 & -1 \\ 5 & -4 & -3 & -2 & -1 \end{vmatrix} = 15 \begin{vmatrix} 1 & 2 & 3 & -1 \\ 1 & 2 & -2 & -1 \\ 1 & -3 & -2 & -1 \\ -4 & -3 & -2 & -1 \end{vmatrix}$$

$R_1 - R_2, R_3 - R_2, R_4 - R_2,$ gives

$$15 \begin{vmatrix} 0 & 0 & 5 & 0 \\ 1 & 2 & -2 & -1 \\ 0 & -5 & 0 & 0 \\ -5 & -5 & 0 & 0 \end{vmatrix} = 1875, \{\text{the proposition (A) is verified to be true}\}$$

The proof for the general case though clumsy is based on similar lines.

Generalization:

This can be further generalized by considering an arithmetic progression with the first term as a and the common difference as d and we can define

Smarandache Cyclic Arithmetic determinant sequence as

$$\begin{vmatrix} a \end{vmatrix}, \begin{vmatrix} a & a+d \\ a+d & a \end{vmatrix}, \begin{vmatrix} a & a+d & a+2d \\ a+d & a+2d & a \\ a+2d & a & a+d \end{vmatrix}, \dots$$

Conjecture-1:

$$T_n = (-1)^{\lfloor n/2 \rfloor} S_n \cdot d^{n-1} \cdot n^{n-2} = (-1)^{\lfloor n/2 \rfloor} \cdot \{a + (n-1)d\} \cdot \{1/2\} \cdot \{nd\}^{n-1}$$

Where S_n is the sum of the first n terms of the AP

Open Problem: To develop a formula for the sum of n terms of the sequence.

(2) Smarandache Bisymmetric Determinant Sequences:

(a) Smarandache Bisymmetric Determinant Natural Sequence:

The determinants are symmetric along both the leading diagonals hence the name.

$$\begin{vmatrix} 1 \end{vmatrix}, \begin{vmatrix} 1 & 2 \\ 2 & 1 \end{vmatrix}, \begin{vmatrix} 1 & 2 & 3 \\ 2 & 3 & 2 \\ 3 & 2 & 1 \end{vmatrix}, \begin{vmatrix} 1 & 2 & 3 & 4 \\ 2 & 3 & 4 & 3 \\ 3 & 4 & 3 & 2 \\ 4 & 3 & 2 & 1 \end{vmatrix}, \dots$$

$$1, -3, -12, \dots, 40, \dots$$

This suggests the possibility of the n^{th} term as

$$T_n = (-1)^{\lfloor n/2 \rfloor} \{n(n+1)\} \cdot 2^{n-3} \quad (\text{B})$$

We verify this for $n = 5$, and the general case can be dealt with on similar lines.

$$T_5 = \begin{vmatrix} 1 & 2 & 3 & 4 & 5 \\ 2 & 3 & 4 & 5 & 4 \\ 3 & 4 & 5 & 4 & 3 \\ 4 & 5 & 4 & 3 & 2 \\ 5 & 4 & 3 & 2 & 1 \end{vmatrix}$$

on carrying out following elementary operations

(b) $R_1 = \text{sum of all the rows}$, (b) taking 15 common from the first row, we get

$$15 \begin{vmatrix} 1 & 2 & 3 & 2 \\ 1 & 2 & 1 & 0 \\ 1 & 0 & -1 & -2 \\ -1 & -2 & -3 & -4 \end{vmatrix}$$

$R_1 = R_1 + R_4$ gives

$$15 \begin{vmatrix} 0 & 0 & 0 & -2 \\ 1 & 2 & 1 & 0 \\ 1 & 0 & -1 & -2 \\ -1 & -2 & -3 & -4 \end{vmatrix} = 120, \text{ which confirms with (B)}$$

The proof of the general case can be based on similar lines.

Generalization: We can generalize this also in the same fashion by considering an arithmetic progression as follows:

$$\begin{vmatrix} a \end{vmatrix}, \begin{vmatrix} a & a+d \\ a+d & a \end{vmatrix}, \begin{vmatrix} a & a+d & a+2d \\ a+d & a+2d & a+d \\ a+2d & a+d & a \end{vmatrix}, \dots$$

Conjecture-2: The general term of the above sequence is given by

$$T_n = (-1)^{\lfloor n/2 \rfloor} \cdot \{ a + (n-1)d \} \cdot 2^{n-3} \cdot d^{n-1}$$

SMARANDACHE REVERSE AUTO CORRELATED SEQUENCES AND SOME FIBONACCI DERIVED SMARANDACHE SEQUENCES

(Amarnath Murthy, S.E.(E&T), WLS, Oil and Natural Gas Corporation Ltd., Sabarmati, Ahmedabad,-380005 INDIA.)

Let a_1, a_2, a_3, \dots be a base sequence. We define a **Smarandache Reverse Auto-correlated Sequence (SRACS)** b_1, b_2, b_3, \dots as follow :

$b_1 = a_1^2, b_2 = 2a_1a_2, b_3 = a_2^2 + 2a_1a_3, \dots$ by the following transformation

$$b_n = \sum_{k=1}^n a_k \cdot a_{n-k+1}$$

and such a transformation as **Smarandache Reverse Auto Correlation Transformation (SRACT)**

We consider a few base sequences.

(1) $1, 2, 3, 4, 5, \dots$

i.e. ${}^1C_1, {}^2C_1, {}^3C_1, {}^4C_1, {}^5C_1, \dots$

The SRACS comes out to be

$1, 4, 10, 20, 35, \dots$ which can be rewritten as

i.e. ${}^3C_3, {}^4C_3, {}^5C_3, {}^6C_3, {}^7C_3, \dots$ we can call it SRACS(1)

Taking this as the base sequence we get SRACS(2) as

$1, 8, 36, 120, 330, \dots$ which can be rewritten as

i.e. ${}^7C_7, {}^8C_7, {}^9C_7, {}^{10}C_7, {}^{11}C_7, \dots$. Taking this as the base sequence we get SRACS(3) as

$1, 16, 136, 816, 3876, \dots$

i.e. ${}^{15}C_{15}, {}^{16}C_{15}, {}^{17}C_{15}, {}^{18}C_{15}, {}^{19}C_{15}, \dots,$

This suggests the possibility of the following :

conjecture-I

The sequence obtained by 'n' times Smarandache Reverse Auto Correlation Transformation (SRACT) of the set of natural numbers is given by the following:

SRACS(n)

${}^{h-1}C_{h-1}, {}^hC_{h-1}, {}^{h+1}C_{h-1}, {}^{h+2}C_{h-1}, {}^{h+3}C_{h-1}, \dots$ where $h = 2^{n+1}$.

(2) **Triangular number as the base sequence:**

1, 3, 6, 10, 15, ...

i.e. ${}^2C_2, {}^3C_2, {}^4C_2, {}^5C_2, {}^6C_2, \dots$

The SRACS comes out to be

1, 6, 21, 56, 126, ... which can be rewritten as

i.e. ${}^5C_5, {}^6C_5, {}^7C_5, {}^8C_5, {}^9C_5, \dots$ we can call it SRACS(1)

Taking this as the base sequence we get SRACS(2) as

1, 12, 78, 364, 1365, ...

i.e. ${}^{11}C_{11}, {}^{12}C_{11}, {}^{13}C_{11}, {}^{14}C_{11}, {}^{15}C_{11}, \dots$, Taking this as the base sequence we get SRACS(3) as

1, 24, 300, 2600, 17550, ...

i.e. ${}^{23}C_{23}, {}^{24}C_{23}, {}^{25}C_{23}, {}^{26}C_{23}, {}^{27}C_{23}, \dots$,

This suggests the possibility of the following

conjecture-II

The sequence obtained by 'n' times Smarandache Reverse Auto Correlation transformation (SRACT) of the set of Triangular numbers is given by

SRACS(n)

${}^{h-1}C_{h-1}, {}^hC_{h-1}, {}^{h+1}C_{h-1}, {}^{h+2}C_{h-1}, {}^{h+3}C_{h-1}, \dots$ where $h = 3.2^n$.

This can be generalised to conjecture the following:

Conjecture-III :

Given the base sequence as ${}^nC_n, {}^{n+1}C_n, {}^{n+2}C_n, {}^{n+3}C_n, {}^{n+4}C_n, \dots$

The SRACS(n) is given by

${}^{h-1}C_{h-1}, {}^hC_{h-1}, {}^{h+1}C_{h-1}, {}^{h+2}C_{h-1}, {}^{h+3}C_{h-1}, \dots$ where $h = (n+1).2^n$.

SOME FIBONACCI DERIVED SMARANDACHE SEQUENCES

1. Smarandache Fibonacci Binary Sequence (SFBS):

In Fibonacci Rabbit problem we start with an immature pair 'I' which matures after one season to 'M'. This mature pair after one season stays alive and breeds a new immature pair and we get the following sequence

$I \rightarrow M \rightarrow MI \rightarrow MIM \rightarrow MIMMI \rightarrow MIMMIMIM \rightarrow MIMMIMIMMIMMI$

If we replace I by 0 and M by 1 we get the following binary sequence

$0 \rightarrow 1 \rightarrow 10 \rightarrow 101 \rightarrow 10110 \rightarrow 10110101 \rightarrow 1011010110110$

The decimal equivalent of the above sequences is

$0 \rightarrow 1 \rightarrow 2 \rightarrow 5 \rightarrow 22 \rightarrow 181 \rightarrow 5814$

we define the above sequence as the SFBS

We derive a reduction formula for the general term:

From the binary pattern we observe that

$$T_n = T_{n-1} T_{n-2} \text{ \{the digits of the } T_{n-2} \text{ placed to the left of the digits of } T_{n-1} \text{\}}$$

Also the number of digits in T_r is nothing but the r^{th} Fibonacci number by definition. Hence we have

$$T_n = T_{n-1} \cdot 2^{F(n-2)} + T_{n-2}$$

Problem: 1. How many of the above sequence are primes?

2. How many of them are Fibonacci numbers?

(2)Smarandache Fibonacci product Sequence:

The Fibonacci sequence is 1, 1, 2, 3, 5, 8, . . .

Take $T_1 = 2$, and $T_2 = 3$ and then $T_n = T_{n-1} \cdot T_{n-2}$ we get the following sequence

2, 3, 6, 18, 108, 1944, 209952 -----(A)

In the above sequence which is just obtained by the first two terms, the whole Fibonacci sequence is inherent. This will be clear if we rewrite the above sequence as below:

$$2^1, 3^1, 2^1 3^1, 2^1 3^2, 2^2 3^3, 2^3 3^5, 2^5 3^8, \dots$$

$$\text{we have } T_n = 2^{F_{n-1}} \cdot 3^{F_n}$$

The above idea can be extended by choosing r terms instead of two only and define

$$T_n = T_{n-1} T_{n-2} T_{n-3} \dots T_{n-r} \text{ for } n > r.$$

**Conjecture : (1) The following sequence obtained by incrementing the sequence (A) by 1
3, 4, 7, 19, 1945, 209953 . . . contains infinitely many primes .
(2) It does not contain any Fibonacci number.**

SMARANDACHE STRICTLY STAIR CASE SEQUENCE

Amarnath Murthy, S.E.(E&T), WLS, Oil and Natural Gas Corporation Ltd.,
Sabarmati, Ahmedabad,-380005 INDIA.

Given a number system with base 'b'. We define a sequence with the following postulates:

1. Numbers are listed in increasing order.
2. In a number the k^{th} digit is less than the $(k+1)^{\text{th}}$ digit.

Before we proceed with the general case, let us consider the case with $b=6$. We get the following sequence.

1, 2, 3, 4, 5, 12, 13, 14, 15, 23, 24, 25, 34, 35, 45, 123, 124, 125, 134, 135, 145, 234, 235, 245, 345, 1234, 1235, 1245, 1345, 2345, 12345.

For convenience we write the terms row wise with the r^{th} row containing numbers with r digits.

- (1) 1, 2, 3, 4, 5, $\{ {}^5C_1 = 5 \text{ numbers} \}$
- (2) 12, 13, 14, 15, 23, 24, 25, 34, 35, 45, $\{ {}^5C_2 = 10 \text{ numbers} \}$
- (3) 123, 124, 125, 134, 135, 145, 234, 235, 245, 345, $\{ {}^5C_3 = 10 \text{ numbers} \}$
- (4) 1234, 1235, 1245, 1345, 2345, $\{ {}^5C_4 = 5 \text{ numbers} \}$
- (5) 12345. $\{ {}^5C_5 = 1 \text{ number} \}$

Following properties can be noticed which are quite evident and can be proved easily.

**** We take (nothing) space as a number with zero number of digits.**

- (1) There are ${}^{b-1}C_r$ (5C_r in this case) numbers having exactly r digits.
- (2) There are 2^{b-1} ($2^5=32$, in this case) numbers in the finite sequence including the space which is considered as the lone number with zero digits.
3. The sum of the product of the digits of the numbers having exactly r digits is the absolute value of the r^{th} term in the b^{th} row of the array of the Stirling numbers of the First kind.
4. The sum of all the sums considered in (3) = $b! - 1$ ($6! - 1 = 719$ in this case).

Open Problems:

1. To derive an expression for the sum of all the r digit numbers and thus for the sum of the whole sequence.
2. We define the n^{th} number in the sequence to have index n . Given a number in the sequence to find it's index.

About a new Smarandache-type sequence

Csaba Bíró, University of Szeged

In this paper we will discuss about a problem that I asked about 8 years ago, when I was interested mainly in computer science. The computers can operate with 256 characters and all of them has an ASCII code which is an integer from 0 to 255. If you press ALT key and you type a number, the character of the number will appear. But if you type a number that is greater than 255, the computer will calculate the remainder after division by 256, and the corresponding character will appear. "Can you show each character by pressing the same number key k -times?" - asked I.

It is quite simple to solve this problem, and the answer is no. Before proving this we generalize the problem to t -size ASCII code-tables, the codes are from 0 to $t-1$.

We shall use the following notations: \mathbf{N} is the set of the positive integers, $\mathbf{N}_0 = \mathbf{N} \cup \{0\}$, \mathbf{Z} is the set of the integers and $\mathbf{Z}_t = \{0, 1, \dots, t-1\}$.

Now let us see the generalized problem. Define $f: \mathbf{N} \rightarrow \mathbf{N}$ as

$$f(t) = |H_t|$$

where

$$H_t = \left\{ x \in \mathbf{Z}_t : a \sum_{i=0}^k 10^i \equiv x \pmod{t} \text{ for some } k \in \mathbf{N}_0 \text{ and } a \in \{0, 1, \dots, 9\} \right\}$$

Our first question was $f(256)$, and the generalized problem is to calculate $f(t)$ in generality.

It is clear that $f(t)=t$ if $t \leq 10$, and $f(t) \geq 10$ if $t > 10$. Now let us examine some special cases.

Let $t = 2^r 5^s$, $r, s \in \mathbf{N}_0$ but at least one of them is not zero. Denote by w the maximum of r and s . If $k \geq w$, then $t | 10^k$, because $10^k = 2^k 5^k$. So

$$a \sum_{i=0}^k 10^i \equiv a \sum_{i=0}^{w-1} 10^i \pmod{t},$$

thus

$$H_t = \left\{ x \in \mathbf{Z}_t : a \sum_{i=0}^k 10^i \equiv x \pmod{t} \quad k \in \mathbf{Z}_w \text{ and } a \in \{0, 1, \dots, 9\} \right\}$$

So $|H_t| \leq 10w$, moreover $|H_t| \leq 9w+1$, because if $a=0$, then the value of k is insignificant.

We got a sufficient condition for $f(t) < t$, that is $t > 9w + 1$. It is satisfied if $r \geq 6$ or $s \geq 2$ or $r = 2, 3, 4, 5$ and $s = 1$. If $r = 0, 1$ and $s < 2$, or $r = 2, 3$ and $s = 0$ then $t \leq 10$ so we have only 2 cases to examine: $t = 16$ and $t = 32$. In the former, $f(16) = 16$, because $10 \equiv 666$, $12 \equiv 44$, $13 \equiv 77$, $14 \equiv 222$, $15 \equiv 111 \pmod{16}$, but in the latter $f(32) < 32$; for example anybody can verify that $16 \notin H_{32}$ (by the way $f(32) = 26$). Specially we got the answer for our first question: $f(256) = f(2^8) < 256$, because $256 > 9 \cdot 8 + 1$. In fact $f(256) = 60$. (Some of these results are computed by a Pascal program.)

In the next case let $t = 10^r + 1$, $r \geq 1$. Take a number $d = a(1 + 10 + 100 + \dots + 10^i)$. Now it is easy to see, that the remainder of d may be $0, a, 10a, 10a + a, 100a, 100a + 10a, 100a + 10a + a, \dots, 10^{r-1}a + 10^{r-2}a + \dots + a$, so the remainder is less than 10^r . Thus $10^r \notin H_t$, so we got $f(t) < t$.

Now we will show a simple algorithm to calculate $f(t)$. Fix a and let R_i be the remainder of $10^i a$ and S_i the sum of the first i elements of the sequence $\{R_n\} \pmod{t}$. It is obvious that both $\{R_n\}$ and $\{S_n\}$ are periodic, so let l be the end of the first period of $\{S_n\}$. ($S_l = S_{l'}$ for some $l' < l$.)

Then

$$H_t = \left\{ x \in \mathbf{Z}_t : a \sum_{i=0}^k 10^i \equiv x \pmod{t} \quad k \in \mathbf{Z}_t \text{ and } a \in \{0, 1, \dots, 9\} \right\}$$

so it is easy to calculate $|H_t|$. The time complexity of this algorithm is at most $O(n^2)$.

Finally let us see a table of the values of the function f , computed by a computer.

t	1...10	11	12	13	14	15	16	17	18	19	20	...	256
$f(t)$	1...10	10	12	13	14	15	16	17	18	19	15	...	60

$10 \equiv 666 \pmod{12}$	$10 \equiv 88 \pmod{13}$ $12 \equiv 77 \pmod{13}$	$10 \equiv 66 \pmod{14}$ $12 \equiv 222 \pmod{14}$ $13 \equiv 55 \pmod{14}$	$10 \equiv 55 \pmod{15}$ $12 \equiv 222 \pmod{15}$ $13 \equiv 88 \pmod{15}$ $14 \equiv 44 \pmod{15}$
$10 \equiv 666 \pmod{16}$ $12 \equiv 44 \pmod{16}$ $13 \equiv 77 \pmod{16}$ $14 \equiv 222 \pmod{16}$ $15 \equiv 111 \pmod{16}$	$10 \equiv 44 \pmod{17}$ $12 \equiv 777 \pmod{17}$ $13 \equiv 999 \pmod{17}$ $14 \equiv 99 \pmod{17}$ $15 \equiv 66 \pmod{17}$ $16 \equiv 33 \pmod{17}$	$10 \equiv 22222 \pmod{18}$ $12 \equiv 66 \pmod{18}$ $13 \equiv 1111 \pmod{18}$ $14 \equiv 8888 \pmod{18}$ $15 \equiv 33 \pmod{18}$ $16 \equiv 88 \pmod{18}$ $17 \equiv 77777 \pmod{18}$	$10 \equiv 333 \pmod{19}$ $12 \equiv 88 \pmod{19}$ $13 \equiv 222 \pmod{19}$ $14 \equiv 33 \pmod{19}$ $15 \equiv 8888 \pmod{19}$ $16 \equiv 111 \pmod{19}$ $17 \equiv 55 \pmod{19}$ $18 \equiv 2222 \pmod{19}$

Now we still have the question: for which numbers $f(t)=t$? Are there finite or infinite many t with the property above? Is there a better (faster) algorithm to calculate $f(t)$? Is there an explicit formula? Can anyone answer?

BIBLIOGRAPHY

- [1] GYARMATI Edit-TURÁN Pál: Számelmélet
Nemzeti Tankönyvkiadó, Budapest, 1995.
- [2] Fritz REINHARD-Heinrich SOEDER: dtv-Atlas zur Mathematik
Deutscher Taschenbuch Verlag GmbH & Co. Kg, München, 1974. and 1977.

Address:

*József Attila Tudományegyetem
Bolyai Intézet
Aradi vértanúk tere 1.
6720 Szeged
HUNGARY*

E-mail:

csabci@edge.stud.u-szeged.hu

On the Smarandache Paradox

Leonardo Motta
lmotta@amazon.com.br

*Conselheiro Furtado, 1574/501
Belém, PA 66040-100, Brazil*

Abstract

The Smarandache Paradox is a very interesting paradox of logic because it has a background common sense. However, at the same time, it gets in a contradiction with itself. Although it may appear well cohesive, a careful look on the science definition and some logic can break down this paradox showing that it exist only when we are trying to mix two different universes, where in one we have two possibilities and in the other we have only one. When we try to understand the second possibility in the universe which has only one possibility, we end in the Smarandache Paradox.

1. On the Smarandache Paradox

The Smarandache paradox can be enunciated as follows. Let A be some attribute (e.g., possible, present, perfect, etc.). If everything is A , than the opposite of A must be also A ! For example, “All is possible, the impossible too” and “Nothing is perfect, not even the perfect” [1]. This paradox is very interesting because it has its logic but it makes no sense at the same time.

It's very easy to break down this paradox by simply taking a careful look on the definition of science. If we have two possible states, but the whole universe is immerse on only one of the states, then there's no sense talking about another state. It does not exist at all. The same logic can be applied on the Smarandache paradox.

Let P be a Boolean property (i.e., it assume only “true” or “false”, “0” or “1”, etc., as value). Now, suppose we have a group of particles that have this property, where half particles are $P = \text{true}$ and the other half $P = \text{false}$. Restrictively in this group, say G_1 , its possible to have both properties. However, if we define another group, G_2 , where all particles are $P = \text{true}$, then it makes no sense talking about $P = \text{false}$ in that group because that property does not exist at all. In other words, if all is possible, then it makes no sense saying that even the impossible is, because in this group we do not have any impossibility. It's a mistake trying to say that even the $P = \text{false}$ is $P = \text{true}$ in G_2 because in that universe P does not assume any value different from “true”.

Moreover, if we have a group where nothing is perfect, then the perfection does not exist in that group. The paradox simply tries to get the perfection, which is possible in other groups, to this particular group where it is not. Thus, a truth for a particular group may be not true for another one.

Another way to get to this conclusion is by the principle of science stating that if we cannot deny it, then it does not exist. For instance, let me take the great example of the dragon in the garage of Carl Sagan [2]. If you tell me that you have a dragon on your garage, then I would ask you to take me there to prove it. However, when we get there and you shown me it, there's nothing there for me. You say that the dragon is invisible. Therefore, I ask you to throw some flour on the ground, so we could see the steps of the dragon. Now you say that the dragon is always flying. So I ask to use some infra-red detector to "see" the dragon fire. Now you say that the fire of the dragon is heatless. Patiently, I suggest throwing paint all over the garage so we could see him. Nevertheless, you say that the dragon is actually not made of matter. Now I ask you what is the sense in talking about a dragon like this? Why don't we just say that the dragon does not exist at all? Accordingly, if even the impossible is possible, then impossibility does not exist and therefore we can exclude it and have only the possibility. Consequently, is impossible to talk about impossibility in a restrict universe where only possibility is allowed.

2. CONCLUSION

The example of the groups of particles with the property P showed here, lead us to the fact that the Smarandache Paradox exist only when we are trying to understand the meaning of $P = \mathbf{false}$ in a universe where only $P = \mathbf{true}$ is allowed. Yet, the definition of science make clear that there is no sense in P being false in a universe where all P s are true.

References

- [1] Weisstein, Eric. *World of Mathematics*, "Smarandache Paradox"
<http://mathworld.wolfram.com/SmarandacheParadox.html>
- [2] Sagan, Carl. *The Demon-Haunted World*, Chap. 10

New Prime Numbers

Sebastián Martín Ruiz

I have found some new prime numbers using the PROTH program of Yves Gallot. This program is based on the following theorem:

Proth Theorem (1878):

Let $N = k \cdot 2^n + 1$ where $k < 2^n$. If there is an integer number a so that $a^{\frac{N-1}{2}} \equiv -1 \pmod{N}$ therefore N is prime.

The Proth program is a test for primality of greater numbers defined as $k \cdot b^n + 1$ or $k \cdot b^n - 1$. The program is made to look for numbers of less than 5.000000 digits and it is optimized for numbers of more than 1000 digits..

Using this Program, I have found the following prime numbers:

$3239 \cdot 2^{12345} + 1$	with 3720 digits	$a = 3, a = 7$
$7551 \cdot 2^{12345} + 1$	with 3721 digits	$a = 5, a = 7$
$7595 \cdot 2^{12345} + 1$	with 3721 digits	$a = 3, a = 11$
$9363 \cdot 2^{12321} + 1$	with 3713 digits	$a = 5, a = 7$

Since the exponents of the first three numbers are Smarandache number $Sm(5)=12345$ we can call this type of prime numbers, prime numbers of Smarandache .

Helped by the MATHEMATICA program, I have also found new prime numbers which are a variant of prime numbers of Fermat. They are the following:

$$2^{2^n} \cdot 3^{2^n} - 2^{2^n} - 3^{2^n} \text{ for } n=1, 4, 5, 7 .$$

It is important to mention that for $n=7$ the number which is obtained has 100 digits.

Chris Nash has verified the values $n=8$ to $n=20$, this last one being a number of 815.951 digits, obtaining that they are all composite. All of them have a tiny factor except $n=13$.

References:

Smarandache Factors and Reverse Factors. Micha Fleuren. Smarandache Notions Journal Vol. 10.

www.gallup.unm.edu/~Smarandache.

The Prime Pages. www.utm.edu/research/primes

Avda. de Regla 43. Chipiona 11550 Spain

Smaranda@teleline.es.

A NOTE ON THE VALUES OF ZETA

TAEKYUN KIM

Carlitz considered the numbers $\eta_k(q)$ which are determined by

$$\eta_0(q) = 0, \quad (q\eta(q) + 1)^k - \eta_k(q) = \begin{cases} 1 & \text{if } k = 1 \\ 0 & \text{if } k > 1. \end{cases}$$

These numbers $\eta_k(q)$ induce Carlitz's k th q -Bernoulli numbers $\beta_k(q) = \beta_k$ as

$$\beta_0 = 1, \quad q(q\beta + 1)^k - \beta_k = \begin{cases} 1 & \text{if } k = 1 \\ 0 & \text{if } k > 1 \end{cases}$$

where we use the usual convention about replacing β^i by β_i ($i \geq 0$).

Now, we modify the above number $\eta_m(q)$, that is,

$$B_0(q) = \frac{q-1}{\log q}, \quad (qB(q) + 1)^k - B_k(q) = \begin{cases} 1 & \text{if } k = 1 \\ 0 & \text{if } k > 1. \end{cases}$$

where we use the usual convention about replacing $B^i(q)$ by $B_i(q)$ ($i \geq 0$).

In [1], I have constructed a complex q -series which is a q -analogue of Hurwitz's ζ -function. In this a short note, I will compute the values of zeta by using the q -series.

Let $F_q(t)$ be the generating function of $B_i(q)$:

$$F_q(t) = \sum_{k=0}^{\infty} B_k(q) \frac{t^k}{k!} \quad \text{for } q \in \mathbb{C} \text{ with } |q| < 1.$$

This is the unique solution of the following q -difference equation:

$$F_q(t) = e^t F_q(qt) - t.$$

It is easy to see that

$$F_q(t) = -t \sum_{n=0}^{\infty} q^n e^{[n]t} + \frac{q-1}{\log q} e^{\frac{1}{1-q}t}.$$

1991 *Mathematics Subject Classification.* 10A40.

Thus we have:

$$B_k(q) = \frac{d^k}{dt^k} F_q(t) \Big|_{t=0} = -k \sum_{n=0}^{\infty} q^n [n]^{k-1} + \frac{(-1)^k}{(q-1)^{k-1} \log q}.$$

Hence, we can define a q -analogue of the ζ -function as follows:

For $s \in \mathbb{C}$, define (see[1])

$$\zeta_q(s) = \sum_{n=1}^{\infty} \frac{q^n}{[n]^s} - \frac{1}{s-1} \frac{(1-q)^s}{\log q}.$$

Note that, $\zeta_q(s)$ is analytic continuation in \mathbb{C} with only one simple pole at $s = 1$ and

$$\zeta_q(1-k) = -\frac{B_k(q)}{k} \quad \text{where } k \text{ is any positive integer.}$$

Now, we define q -Bernoulli polynomial $B_n(x; q)$ as

$$B_n(x; q) = (q^x B(q) + [x])^n = \sum_{k=0}^n \binom{n}{k} q^{xk} B_k(q) [x]^{n-k}.$$

Let $T_q(x, t)$ be generating function of q -Bernoulli polynomials.

Note that

$$T_q(x, t) = F_q(q^x t) e^{[x]t}.$$

Thus

$$\begin{aligned} B_{k+1}(x; q) &= \frac{d^{k+1}}{dt^{k+1}} T_q(x, t) \Big|_{t=0} \\ &= -(k+1) \sum_{n=0}^{\infty} ([n]q^x + [x])^k q^{n+x} + \frac{q-1}{\log q} \left(\frac{1}{q-1} \right)^{k+1}. \end{aligned}$$

So, we can also define a q -analogue of the Hurwitz ζ -function as follows:

For $s \in \mathbb{C}$, (see [1])

$$\begin{aligned} \zeta_q(s, x) &= \sum_{n=0}^{\infty} \frac{q^{n+x}}{([n]q^x + [x])^s} - \frac{(1-q)^s}{\log q} \frac{1}{s-1} \\ &= \sum_{n=0}^{\infty} \frac{q^{n+x}}{[n+x]^s} - \frac{(1-q)^s}{\log q} \frac{1}{s-1}, \quad 0 < x \leq 1. \end{aligned}$$

Note that, $\zeta_q(s, x)$ has an analytic continuation in \mathbb{C} with only one simple pole at $s = 1$.

Remark. $\zeta_q(s, x)$ is called q -analogue of Hurwitz ζ -function.

For $u \in \mathbb{C}$ with $u \neq 0, 1$, let $H_k(u : q)$ be q -Euler numbers (See [4]). It is known in [4] that $H_k(u : 1) = H_k(u)$ is the ordinary Euler number which is defined by

$$\frac{1-u}{e^t - u} = \sum_{k=0}^{\infty} H_k(u) \frac{t^k}{k!}.$$

In the case $u = -1$, $H_k(-1) = E_k$ is the classical Euler number is defined by

$$\frac{2}{e^t + 1} = \sum_{n=0}^{\infty} E_n \frac{t^n}{n!}.$$

Note that $E_{2k} = 0$ ($k \geq 1$). In [4], $\ell_q(s, u)$ is defined by $\ell_q(s, u) = \sum_{n=1}^{\infty} \frac{u^{-n}}{[n]_q^s}$ and $\ell_q(-k, u) = \frac{u}{u-1} H_k(u : q)$ for $k > 1$.

Theorem 1. For $s \in \mathbb{C}$, $f \in \mathbb{N} \setminus \{1\}$, we have

- (1) $\sum_{n=1}^{\infty} \frac{(-1)^n}{[n]_q^s} q^n = -\zeta_q^*(s) + \frac{2}{[2]_q^s} \zeta_q^{*2}(s)$.
- (2) $\zeta_q^*(s) = \frac{1}{[f]_q^s} \sum_{a=1}^f \zeta_{q^a}^*(s, \frac{a}{f})$, where $\zeta_q^*(s) = \sum_{n=1}^{\infty} \frac{q^n}{[n]_q^s}$.

It is easy to see that

$$\begin{aligned} & \sum_{n=1}^{\infty} \frac{(-1)^n q^n}{[n]^{2k+1}} \sum_{j=0}^{\infty} \frac{\theta^{2j+1} [n]^{2j+1}}{(2j+1)!} + \frac{1}{\log q} \sum_{j=0}^{k-1} \frac{(1-q)^{2k-2j}}{2k-2j-1} \frac{\theta^{2j+1}}{(2j+1)!} \\ & - \frac{1}{\log q} \sum_{j=0}^{k-1} \frac{\theta^{2j+1}}{(2j+1)!} \frac{(1-q^2)^{2k-2j}}{2k-2j-1} \frac{1}{[2]^{2k-2j}} \\ & = \sum_{j=0}^{k-1} \frac{(-1)^j \theta^{2j+1}}{(2j+1)!} \left(-\zeta_q(2k-2j) + \zeta_{q^2}(2k-2j) \frac{2}{[2]^{2k-2j}} \right) \\ & - \frac{q}{1+q} \frac{\theta^{2k+1}}{(2k+1)!} (-1)^k + \sum_{j=k+1}^{\infty} \frac{\theta^{2j+1} (-1)^j}{(2j+1)!} \frac{q^{-1}}{1+q^{-1}} H_{2j-2k}(-q^{-1}, q). \end{aligned}$$

If $q \rightarrow 1$, then we have

$$\begin{aligned} \sum_{n=1}^{\infty} \frac{(-1)^n}{n^{2k+1}} \sin(n\theta) & = \sum_{j=0}^{k-1} \frac{(-1)^j}{(2j+1)!} \theta^{2j+1} \left(\frac{2}{2^{2k-2j}} - 1 \right) \\ & (-1)^{k-j+1} \frac{(2\pi)^{2k-2j}}{2 \cdot (2k-2j)!} B_{2k-2j} - \frac{1}{2} \frac{\theta^{2k+1}}{(2k+1)!} (-1)^k. \end{aligned}$$

Let $k = 2$ and $\theta = \frac{\pi}{2}$. Then we have

$$\sum_{n=1}^{\infty} \frac{(-1)^n}{(2n+1)^5} = \pi^5 \left(\frac{1}{2^6 \cdot 5!} - \frac{B_2}{2^4 \cdot 3!} + \frac{7}{12} B_4 \right).$$

It is easy to see that

$$\begin{aligned}\sum_{n=1}^{\infty} \frac{(-1)^n}{(2n+1)^5} &= 2 \sum_{n=1}^{\infty} \frac{1}{(4n-3)^5} + \sum_{n=1}^{\infty} \frac{1}{(2n)^5} - \sum_{n=1}^{\infty} \frac{1}{n^5} - 1 \\ &= \frac{1}{2^5} \zeta\left(5, \frac{1}{4}\right) - \frac{2^5-1}{2^5} \zeta(5) - 1.\end{aligned}$$

Thus we have

$$\zeta(5) - \frac{1}{2^4} \frac{1}{2^5-1} \zeta\left(5, \frac{1}{4}\right) - 1 = -2^5 \pi^5 \left(\frac{1}{2^6 \cdot 5!} - \frac{B_2}{2^4 \cdot 3!} + \frac{7}{12} B_4 \right).$$

Therefore we obtain the following:

Proposition 2. $\zeta(5) - \frac{1}{2^4(2^5-1)} \zeta(5, \frac{1}{4}) - 1$ is irrational.

REFERENCES

- [1] T. Kim, *On the Values of q -Analogue of Zeta and L -functions*, Preprint.
- [2] T. Kim, *On a q -analogue of the p -adic log gamma functions and related integrals*, J. Number Theory **76** (1999), 320-329.
- [3] ———, *On explicit formulas of p -adic q - L -functions*, Kyushu J. Math. **48** (1994), 73-86.
- [4] J. Satho, *q -Analogue of Riemann's zeta-function and q -Euler Numbers*, J. Number Theory **31** (1989), 346-362.

TAEKYUN KIM

DEPARTMENT OF MATHEMATICS

KOREAN MINJOK LEADERSHIP ACADEMY

1334, SOSA, KANGWON, KOREA

e-mail: taekyun@minjok-h.ed.kangwon.kr

Ten conjectures on prime numbers

Felice Russo

Via A. Infante

67051 Avezano (Aq) Italy

felice.russo@katamail.com

Abstract

In this paper ten conjectures on prime numbers are reported. With p_n we indicate the n -th prime number. All the conjectures have been verified for all primes $\leq 10^7$.

$$1. \ln(p_{n+1}) - \ln(p_n) < \ln\left(\frac{34283}{8219}\right) \cdot n^{-\ln\frac{1907}{919}}$$

$$2. \frac{p_{n+1} - p_n}{p_{n+1} + p_n} < n^{-\cos\left(\pi \cdot \frac{7}{55}\right) \cdot \cos\left(\pi \cdot \frac{13}{54}\right)}$$

$$3. \frac{e^{\sqrt{\frac{n+1}{p_{n+1}}}}}{e^{\sqrt{\frac{p_n}{n}}}} < \frac{e^{\sqrt{\frac{3}{5}}}}{e^{\sqrt{\frac{3}{2}}}}$$

$$4. |p_n \cdot (n+1) - n \cdot p_{n+1}| < \frac{1}{2} \cdot (n+1)^{\frac{9}{50}}$$

$$5. \ln(p_{n+1} - p_n) - \ln(\sqrt{p_{n+1} - p_n}) < \frac{1}{2} \cdot n^{\frac{3}{10}}$$

$$6. \left| \ln(\sqrt{\ln(p_{n+1})}) - \ln(\sqrt{\ln(p_n)}) \right| < \frac{1}{2n}$$

$$7. \frac{1}{2^{\ln \sqrt{2}}} < \frac{n^{\ln \sqrt{p_{n+1}}}}{(n+1)^{\ln \sqrt{p_n}}} < \frac{30^{\ln \sqrt{127}}}{31^{\ln \sqrt{113}}}$$

$$8. \frac{\sqrt{3} - \ln(3)}{\sqrt{2} - \ln(2)} < \frac{\sqrt{p_{n+1}} - \ln(p_{n+1})}{\sqrt{p_n} - \ln(p_n)} < \frac{\sqrt{11} - \ln(11)}{\sqrt{7} - \ln(7)}$$

$$9. \frac{(\ln(1361))^{\sqrt{1327}}}{(\ln(1327))^{\sqrt{1361}}} < \frac{(\ln(p_{n+1}))^{\sqrt{p_n}}}{(\ln(p_n))^{\sqrt{p_{n+1}}}} < \frac{(\ln(3))^{\sqrt{2}}}{(\ln(2))^{\sqrt{3}}}$$

$$10. \frac{\sqrt{p_n} - \ln(p_{n+1})}{\sqrt{p_{n+1}} - \ln(p_n)} \geq \frac{\sqrt{3} - \ln(5)}{\sqrt{5} - \ln(3)}$$

On some implications of formalized theories in our life

Adrian VasIU

Department of Mathematics,
University of Utah,
Salt Lake City, Utah, USA

Angela VasIU

Department of Mathematics,
Babes-Bolyai University,
Cluj-Napoca, Romania

Abstract

The formalized theories in which are considered different types of logics give us an easier way of understanding of our own interpretations of the concepts and of the events of life.

In the paper "Paradoxist mathematics" [1] Smarandache proved that contradiction is not a catastrophe even in mathematics and he taught us how to handle it. Even more, this can encourage us in our life, for the infinite dimensional capacity of human condition. Through this paper we meditate on the great diversity of human condition seen through the axiomatization of a formalized theory. Thus the science gives some explanations for the life and the life inspires the science.

We denote $S:=(N,R,A)$ an axiomatical system of a formalized theory; N and R are fundamental notions and relations and A is a list of hypothesis propozitions (axioms in the modern meaning).

$$T(S):=<S,\text{consec}S>$$

$T(S)$ is the theory deduced from S and its consequences based on a logic L .

If the great Gauss said that the mathematicians were not prepared to accept the new Geometry of N. Lobacewski and J. Bolyai, today we can see

that the evolution of absolute Geometry [3] brings us a great number of non-euclidean Geometries.

This development and the great varieties of Geometries and Mathematics structures help us in some directions for the self-understanding.

Accordingly to the great illuminated ones we have a sublime inner structure, which could bring us more respect of each other end, also, the self-respect.

Well, then why are we so different? Certainly this depends of the degree in which these innate qualities are left to be manifested or are blocked. We can see different kinds of people who can distinguish each other after the degree of manifestation of their own qualities. This depends of the degree of the ignorance, or of the negligence or even of the denial of one or more of pure aspects of our inside, shortly this is correlated with our "Inner Geometry", a notion introduced by us in [2].

Our "Inner Geometry" can be different from a moment to an other, from a person to an other, and it depends of the self-knowledge, which is a subject which addresses to a seaker of truth with a scientific attitude and is a search since immemorial times. It is the knowledge of all civilizations and of the evolution and so we should treat it with much respect for our benefit.

Each one of us can see that sometimes we feel some of our qualities, but sometimes we substitute them in something opposite. In this way, we can see that our "Inner Geometry" represent an immense variety. Why?

There is an alive complete "instrument" put in our inside. This alive "hipercomputer" works by the manifestation of its powers, by the parasympathetic nervous system and by the right, left and central sympathetic nervous system. All we are doing in our evolution is expressed

by our nervous system. This is an alive, spontaneous and natural process. Our contribution is to leave it to manifest in its natural manner. Usually we disturb it by our: too much worries and irritations. When our pure energy is left to manifest, it connects us, our subtle being, to the Allpervading power of God's Love, of the primordial power who creates and does all alive work. The anterior state can be compared with that of a seed before to be put in the earth.

The Foundation of Geometry could help us to explain the great diversity of human beings. How? Thinking to the some aspects of our "Inner Geometry".

1. Have we, ever, put the questions about our "Inner Geometry"? If we had, we can ask ourselves about of the system $S=(N,R,A)$ which we accept in our existence. We can ask about the order of values in our life.

2. Even the consciousness of the importance of a foundation of our existence is differently understood or accepted, or is denied.

3. The way in which we develop $T(S)$, the degree of the knowledge of $T(S)$ at a given moment, and the logic L we use for $T(S)$ are arguments to a deeper understanding of the diversity of human condition.

4. If we make a choice of the system S , what kind of interpretations give we to the fundamental notions N and relations R ? What significance attribute we to the elements of N , R and A of S ? From here the great human variety.

5. Is it our existence one ful of wisdom, or is it one ful of contradictions and confusions?

Our problems could be naturally solved when in our "inner computer", our competent energy is working in our life. Then we live after natural laws. To imply to these aspects we would dare to stimulate, as a provocation, all

the scientists. We all are invited to pay attention for a better self-understanding and for a more harmonious integration in the life, by using our inner possibilities.

The Foundation of Mathematics invites us to a profound meditation about self-knowledge, to a consciousness of our inner riches and such to avoid to waste our own energies, which could affect our healthiness.

6. The acceptance of our inner possibilities do not suppose an inactivity state, but the actions with much respect and love for our neighbours and for self-respect. Such we assume the responsibility for our facts and this help us not to block some subtle centers of our inner being, of our subtle body and to pay attention to our own Logic *L*.

7. Is this possible in a world full of selfishness? We are even optimistic and encourage our readers for a reflection of what Foundation of a theory provoke us in a correlation with the self-knowledge and the awakening of our inner possibilities, about all illuminaries assure us, even if for the moment, our poor logic is vexed.

When we deny or we use not, one or some of our inner possibilities, our "Inner Geometry" is perturbed from its natural state.

The degradation of the life to which all assist is an explanation of the ignoring of our inner capacities.

In "Paradoxist Mathematics" in [1] the author says about its Anti-Geometries: "everything is considered not in a nihilistic way, but in a positive one". And we agree this. A possible positive way is that of understanding of the actual state of human condition. The new concepts in Mathematics given in [1] were written at a time when the author experienced a political totalitarianism system: "I wanted to be free in life -

hence I got the same feelings in science. It is a revolt against all petrified knowledge" [1].

To these we would add that we could, also, "revolt" in front of this decadence and degradation by considering our greatness about we were created and using it in a more and more wisdom life. How? Through some silent minutes: to be what we are, and so to permit to our subtle body to work after its own laws.

More we experience our nature, closer we are to be free and health. What is a plant without water, or without the light of sun?

When we begin to live our life as an expression of our universality, of our divinity, then we begin to give a correct answer to the question: "who really I am"? Realize I that my essence is a spiritual one? Let us realize this and let us identify with our own essence. This is our right, and this time has come. It is like the time to bloom flowers. We all potentially have so many availabilities of love, of serenity, of peace, of creativity. They are available. Let all consider them and identify with them. Then we enjoy of our inner innate qualities and the divine power, who is in all beings as consciousness as intelligence, as the power of reflection, of modesty, of peace, of compassion, of satisfaction and others, can work naturally. When we experience the power of the Self, we can see that the ego is not, who really I am. The ego is our self-image, it is our social mask, it is the role we are playing in society. But I am my pure essence. So, ego, is not my true identification.

Our true nature is completely free of fear, because it recognizes in every one else, the same pure nature and even in his errors can do the difference between what the essence is and what is not.

How to get our correct identification? A deep and pure desire that what is divine in us to manifest; all days not to forget to spend a time in the nature, and to have a short time at least, to simply Be, to realize that it is a responsibility to contribute to our own evolution with sincerity, making important steps to understand the laws of nature, based not on a blind faith, but on a real one, what can be verified.

Through all we mentioned in this paper we would like to do the Mathematics a force of life for our better understanding and a force which invite us to use more and more our inner life, which were not enough explored.

References

1. Smarandache Florentin, *Collected Papers*, Vol.II, University of Kishinev Press Kishinev, p.5-28, 1997.
2. Vasiu Adrian, Vasiu Angela, *The Foundation of natural integration in the life*, Dokia Publishing House Ltd., 1998 (in romanian).
3. Angela Vasiu, N. Oprea, *From Bolyai's Geometry to Smarandache Anti-Geometry*, Smarandache Notions Journal, Vol.11, p.24-27, 1999.

DECOMPOSITION OF THE DIVISORS OF A NATURAL NUMBER INTO PAIRWISE CO-PRIME SETS

(Amarnath Murthy, S.E. (E&T), Well Logging Services, Oil and Natural Gas corporation Ltd., Sabarmati, Ahmedabad, 380 005 , INDIA.)

Given n a natural number . Let $d_1, d_2, d_3, d_4, d_5, \dots$ be the divisors of N . A query comes to my mind, as to, in how many ways , we could choose a divisor pair which are co-prime to each other? Similarly in how many ways one could choose a triplet, or a set of four divisors etc. such that, in each chosen set, the divisors are pairwise co-prime.?

We start with an example Let $N = 48 = 2^4 \times 3$. The ten divisors are

1 , 2 , 3 , 4 , 6 , 8 , 12 , 16 , 24 , 48

We denote set of co-prime pairs by $D_2(48)$, co-prime triplets by $D_3(48)$ etc.

We get $D_2(48) = \{ (1,2) , (1, 3) , (1, 4) , (1, 6) , (1,8) , (1, 12) , (1,16) , (1, 24) , (1, 48) , (2, 3) , (4,3) , (8, 3) , (16, 3) \}$

Order of $D_2(48) = 13$.

$D_3(48) = \{ (1,2, 3) , (1, 3, 4) , (1, 3, 8) , (1,3, 16) \}$, **Order of $D_3(48) = 4$.**

$D_4(48) = \{ \} = D_5(48) = \dots = D_9(48) = D_{10}(48)$.

Another example $N = 30 = 2 \times 3 \times 5$ (a square free number). The 8 divisors are

1 , 2 , 3 , 5 , 6 , 10 , 15 , 30

$D_2(30) = \{ (1,2) , (1, 3) , (1, 5) , (1, 6) , (1, 10) , (1, 15) , (1, 30) , (2, 3) , (2, 5) , (2, 15) , (3, 5) , (3, 10) , (5, 6) \}$.

Order of $D_2(30) = 13 = O[D_2(p_1 p_2 p_3)]$ (A)

$D_3(30) = \{ (1,2, 3) , (1, 2, 5) , (1, 3, 5) , (2, 3, 5) , (1, 3, 10) , (1, 5, 6) , (1,2, 15) \}$

Order of $D_3(30) = 7$.

$D_4(30) = \{ (1,2, 3, 5) \}$, **Order of $D_4(30) = 1$.**

OPEN PROBLEM: To determine the order of $D_r(N)$.

In this note we consider the simple case of n being a **square-free number** for $r = 2 , 3$ etc.

(A) $r = 2$

We rather derive a reduction formula for $r = 2$. And finally a direct formula.

Let $N = p_1 p_2 p_3 \dots p_n$ where p_k is a prime for $k = 1$ to n

We denote $D_2(N) = D_2(1\#n)$ for convenience. We shall derive a reduction formula for $D_2(1\#(n+1))$.

Let q be a prime such that $(q, N) = 1$, $(HCF = 1)$

Then $D_2(Nq) = D_2(1\#(n+1))$

1. We have by definition $D_2(1\#n) \subset D_2(1\#(n+1))$

This provides us with $O[D_2(1\#n)]$ elements of $D_2(1\#(n+1))$.

(2) Consider an arbitrarily chosen element (d_k, d_s) of $D_2(1\#n)$. This element when combined with q yields exactly two elements of $D_2(1\#(n+1))$. i.e. (qd_k, d_s) and (d_k, qd_s) .

Hence the set $D_2(1\#n)$ contributes two times the order of itself.

2. The element $(1, q)$ has not been considered in the above mentioned cases hence the total number of elements of $D_2(1\#(n+1))$ are 3 times the order of $D_2(1\#n) + 1$.

$$O[D_2(1\#(n+1))] = 3 \times O[D_2(1\#n)] + 1. \quad (B)$$

Applying Reduction Formula (B) for evaluating $O[D_2(1\#4)]$

From (A) we have $O[D_2(p_1 p_2 p_3)] = O[D_2(1\#3)] = 13$ hence

$$O[D_2(1\#4)] = 3 \times 13 + 1 = 40.$$

This can be verified by considering $N = 2 \times 3 \times 5 \times 7 = 210$. The divisors are

1, 2, 3, 5, 6, 7, 10, 14, 15, 21, 30, 35, 42, 70, 105, 210,

$D_2(210) = \{ (1,2), (1,3), (1,5), (1,6), (1,7), (1,10), (1,14), (1,15), (1,21), (1,30),$

$(1,35), (1,42), (1,70), (1,105), (1,210), (2,3), (2,5), (2,7), (2,15), (2,21),$

$(2,35), (2,105), (3,5), (3,7), (3,10), (3,14), (3,35), (3,70), (5,6), (5,7),$

$(5,14), (5,21), (5,42), (7,6), (7,10), (7,15), (7,30), (6,35), (10,21), (14,15) \}$

$$O[D_2(210)] = 40.$$

The reduction formula (B) can be reduced to a direct formula by applying simple induction and we get

$$O[D_2(1\#n)] = (3^n - 1) / 2 \quad (C)$$

(B) $r = 3$.

For $r = 3$ we derive a reduction formula.

(1) We have $D_3(1\#n) \subset D_3(1\#(n+1))$ hence this contributes $O[D_3(1\#n)]$ elements to $D_3(1\#(n+1))$.

(2) Let us Choose an arbitrary element of $D_3(1\#n)$ say (a, b, c) . The additional prime q yields (qa, b, c) ,

(a, qb, c) , (a, b, qc) i.e. three elements. In this way we get $3 \times O[D_3(1\#n)]$ elements.

3. Let the product of the n primes = N . Let $(d_1, d_2, d_3, \dots, d_{d(N)})$ be all the divisors of N . Consider $D_2(1\#n)$ which contains $d(N) - 1$ elements in which one member is unity = d_1 . i.e., $(1, d_2), (1, d_3), \dots, (1, d_{d(N)})$.

If q is placed as the third element with these as the third element we get $d(N) - 1$ elements of $D_3(1\#(n+1))$. The remaining elements of $D_2(1\#n)$ yield repetitive elements already covered under (2).

Considering the exhaustive contributions from all the three above we get

$$O[D_3(1\#(n+1))] = 4 * O[D_3(1\#n)] + d(N) - 1$$

$$O[D_3(1\#(n+1))] = 4 * O[D_3(1\#n)] + 2^n - 1 \quad \text{(D)}$$

$$O[D_3(210)] = 4 * O[D_3(30)] + 8 - 1$$

$$O[D_3(210)] = 4 * 7 + 8 - 1 = 35$$

To verify the elements are listed below.

$$D_3(210) = \{ (1,2,3), (1,2,5), (1,3,5), (1,2,7), (1,3,7), (1,5,7), (1,2,15), (1,2,21),$$

$$(1,2,35), (1,2,105), (1,3,10), (1,3,14), (1,3,35), (1,3,70), (1,5,6), (1,5,14), (1,5,21),$$

$$(1,5,42), (1,7,6), (1,7,10), (1,7,15), (1,7,30), (2,3,5), (2,3,7), (2,5,7), (2,3,35), (2,5,21),$$

$$(2,7,15), (3,5,7), (3,5,14), (3,7,10), (5,7,6), (1,6,35), (1,10,21), (1,14,15) \}$$

Open Problem : To obtain a direct formula from the reduction formula (D).

Regarding the general case i.e. $O[D_r(1\#n)]$ we derive an inequality.

Let $(d_1, d_2, d_3, \dots, d_r)$ be an element of $O[D_r(1\#n)]$.

Introducing a new prime q other than the prime factors of N we see that this element in conjunction with q gives r elements of $D_r(1\#(n+1))$ i.e. $(qd_1, d_2, d_3, \dots, d_r), (d_1, qd_2, d_3, \dots, d_r), \dots$

$(d_1, d_2, d_3, \dots, qd_r)$.also $D_r(1\#n) \subset D_r(1\#(n+1))$. Hence we get

$$O[D_r(1\#(n+1))] > (r+1) \cdot O[D_r(1\#n)]$$

To find an accurate formula is a tough task ahead for the readers.

Considering the general case is a further challenging job.

SOME NOTIONS ON LEAST COMMON MULTIPLES

(Amarnath Murthy, S.E. (E&T), Well Logging Services, Oil and Natural Gas corporation Ltd., Sabarmati, Ahmedabad, 380 005 , INDIA.)

In [1] Smarandache LCM Sequence has been defined as $T_n = \text{LCM} (1 \text{ to } n) =$
LCM of all the natural numbers up to n.

The SLS is

1, 2, 6, 60, 420, 840, 2520, 2520, . . .

We denote the LCM of a set of numbers a, b, c, d, etc. as $\text{LCM}(a,b,c,d)$

We have the well known result that $n!$ divides the product of any set of n consecutive numbers. Using this idea we define **Smarandache LCM Ratio Sequence** of the r^{th} kind as **SLRS(r)**

The n^{th} term ${}_rT_n = \text{LCM} (n , n+1 , n+2 , \dots , n+r-1) / \text{LCM} (1 , 2 , 3 , 4 , \dots , r)$

As per our definition we get SLRS(1) as

1, 2, 3, 4, 5, . . . ${}_1T_n (= n)$

we get SLRS(2) as

1, 3, 6, 10, . . . ${}_2T_n = n(n+1)/2$ (triangular numbers).

we get SLRS(3) as

$\text{LCM} (1 , 2 , 3) / \text{LCM} (1 , 2 , 3) , \text{LCM} (2 , 3 , 4) / \text{LCM} (1 , 2 , 3) , \text{LCM} (3 , 4 , 5) /$
 $\text{LCM} (1 , 2 , 3)$

$\text{LCM} (4 , 5 , 6) / \text{LCM} (1 , 2 , 3) \text{LCM} (5 , 6 , 7) / \text{LCM} (1 , 2 , 3)$

$\equiv 1 , 2 , 10 , 10 , 35 \dots$ similarly we have

SLRS(4) $\equiv 1 , 5 , 5 , 35 , 70 , 42 , 210 , \dots$

It can be noticed that for $r > 2$ the terms do not follow any visible patterns.

OPEN PROBLEM : To explore for patterns/ find reduction formulae for ${}_rT_n$.

Definition: Like nC_r , the combination of r out of n given objects , We define a new term nL_r

As

${}^nL_r = \text{LCM} (n , n-1 , n-2 , \dots , n-r+1) / \text{LCM} (1 , 2 , 3 , \dots , r)$

(Numerator is the LCM of n , n-1 , n-2, . . . n-r+1 and the denominator is the LCM of first natural numbers.)

we get ${}^1L_0 = 1, {}^1L_1 = 1, {}^2L_0 = 1, {}^2L_1 = 2, {}^2L_2 = 2$ etc. define ${}^0L_0 = 1$

we get the following triangle:

1

1, 1

1, 2, 1

1, 3, 3, 1

1, 4, 6, 2, 1

1, 5, 10,, 10 5, 1

1, 6, 15, 10, 5, 1, 1

1, 7, 21, 35, 35, 7, 7, 1

1, 8, 28, 28, 70, 14, 14, 2, 1

1, 9, 36, 84, 42, 42, 42, 6, 3, 1

1, 10, 45, 60, 210, 42, 42, 6, 3, 1, 1

Let this triangle be called **Smarandache AMAR LCM Triangle**

Note: As $r!$ divides the product of r consecutive integers so does the LCM (1, 2, 3, ... r) divide the LCM of any r consecutive numbers Hence we get only integers as the members of the above triangle.

Following properties of **Smarandache AMAR LCM Triangle** are noticable.

1. The first column and the leading diagonal elements are all unity.
2. The k^{th} column is nothing but the SLRS(k).
3. The first four rows are the same as that of the Pascal's Triangle.
4. IInd column contains natural numbers.
5. IIIrd column elements are the triangular numbers.
6. If p is a prime then p divides all the terms of the p^{th} row except the first and the last which are unity. In other words $\sum p^{\text{th}} \text{ row} \equiv 2 \pmod{p}$

Some keen observation opens up vistas of challenging problems:

In the 9th row 42 appears at three consecutive places.

OPEN PROBLEM:

(1) Can there be arbitrarily large lengths of equal values appear in a row.?

2. To find the sum of a row.
3. Explore for congruence properties for composite n .

SMARANDACHE LCM FUNCTION:

The Smarandache function $S(n)$ is defined as $S(n) = k$ where k is the smallest integer such that n divides $k!$. Here we define another function as follows:

Smarandache Lcm Function denoted by $S_L(n) = k$, where k is the smallest integer such that n divide LCM (1, 2, 3 ... k).

Let $n = p_1^{a_1} p_2^{a_2} p_3^{a_3} \dots p_r^{a_r}$

Let p_m^{am} be the largest divisor of n with only one prime factor, then

We have $S_L(n) = p_m^{\text{am}}$

If $n = k!$ then $S(n) = k$ and $S_L(n) > k$

If n is a prime then we have $S_L(n) = S(n) = n$

Clearly $S_L(n) \geq S(n)$ the equality holding good for n a prime or $n = 4$, $n=12$.

Also $S_L(n) = n$ if n is a prime power. ($n = p^a$)

OPEN PROBLEMS:

- (1) Are there numbers $n > 12$ for which $S_L(n) = S(n)$.
- (2) Are there numbers n for which $S_L(n) = S(n) \neq n$

REFERENCE:

- [1] Amarnath Murthy, Some new smarandache type sequences, partitions and set, SNJ, VOL 1-2-3, 2000.

SMARANDACHE DUAL SYMMETRIC FUNCTIONS AND CORRESPONDING NUMBERS OF THE TYPE OF STIRLING NUMBERS OF THE FIRST KIND

(Amarnath Murthy, S.E. (E&T), Well Logging Services, Oil and Natural Gas corporation Ltd., Sabarmati, Ahmedabad, 380 005 , INDIA.)

In the rising factorial $(x+1)(x+2)(x+3)\dots(x+n)$, the coefficients of different powers of x are the absolute values of the Stirling numbers of the first kind. REF[1].

Let $x_1, x_2, x_3, \dots, x_n$ be the roots of the equation

$$(x+1)(x+2)(x+3)\dots(x+n) = 0.$$

Then the elementary symmetric functions are

$$x_1 + x_2 + x_3 + \dots + x_n = \Sigma x_1, \text{ (sum of all the roots)}$$

$$x_1x_2 + x_1x_3 + \dots + x_{n-1}x_n = \Sigma x_1x_2. \text{ (sum of all the products of the roots taking two at a time)}$$

$$\Sigma x_1x_2x_3\dots x_r = \text{(sum of all the products of the roots taking } r \text{ at a time)}.$$

In the above we deal with sums of products. Now we define **Smarandache Dual symmetric functions** as follows.

We take the product of the sums instead of the sum of the products. The duality is evident. As an example we take only 4 variables say x_1, x_2, x_3, x_4 . Below is the chart of both types of functions

Elementary symmetric functions

(sum of the products)

$$x_1 + x_2 + x_3 + x_4$$

$$x_1x_2 + x_1x_3 + x_1x_4 + x_2x_3 + x_2x_4 + x_3x_4$$

$$x_1x_2x_3 + x_1x_2x_4 + x_1x_3x_4 + x_2x_3x_4$$

$$x_1x_2x_3x_4$$

Smarandache Dual Symmetric functions

(Product of the sums)

$$x_1x_2x_3x_4$$

$$(x_1 + x_2)(x_1 + x_3)(x_1 + x_4)(x_2 + x_3)(x_2 + x_4)(x_3 + x_4)$$

$$(x_1 + x_2 + x_3)(x_1 + x_2 + x_4)(x_1 + x_3 + x_4)(x_2 + x_3 + x_4)$$

$$x_1 + x_2 + x_3 + x_4$$

We define for convenience the product of sums of taking **none** at a time as 1.

Now if we take $x_r = r$ in the above we get the absolute values of the Stirling numbers of the first kind. For the first column.

24, 50, 35, 10, 1.

The corresponding numbers for the second column are **10, 3026, 12600, 24, 1.**

The Triangle of the absolute values of Stirling numbers of the first kind is

1					
1	1				
2	3	1			
6	11	6	1		
24	50	35	10	1	

The corresponding Smarandache dual symmetric Triangle is

1					
1	1				
3	2	1			
6	60	6	1		
10	3026	12600	24	1	

The next row (5th) numbers are

15, 240240 , 2874009600, 4233600, 120 , 1.

Following properties of the above triangle are visible:

- (1) The leading diagonal contains unity.
- (2) The r^{th} row element of the second leading diagonal contains $r!$.
- (3) The First column entries are the corresponding triangular numbers.

Readers are invited to find relations between the two triangles.

Application: Smarandache Dual Symmetric functions give us another way of generalising the **Arithmetic Mean Geometric Mean Inequality**. One can prove easily that

$$(x_1 x_2 x_3 x_4)^{1/4} \leq [\{ (x_1 + x_2) (x_1 + x_3) (x_1 + x_4) (x_2 + x_3) (x_2 + x_4) (x_3 + x_4) \}^{1/6}] / 2 \leq$$

$$[\{ (x_1 + x_2 + x_3) (x_1 + x_2 + x_4) (x_1 + x_3 + x_4) (x_2 + x_3 + x_4) \}^{1/4}] / 3 \leq \{ x_1 + x_2 + x_3 + x_4 \} / 4$$

The above inequality is generally true can also be established easily.

SOME MORE CONJECTURES ON PRIMES AND DIVISORS

(Amarnath Murthy, S.E. (E&T), Well Logging Services, Oil and Natural Gas corporation Ltd., Sabarmati, Ahmedabad, 380 005 , INDIA.)

There are an innumerable numbers of conjectures and unsolved problems in number theory predominantly on primes which have been giving sleepless nights to the mathematicians all over the world for centuries. Here are a few more to trouble them.

(1) Every even number can be expressed as the difference of two primes.

(2) Every even number can be expressed as the difference of two consecutive primes.

i.e. for every m there exists an n such that $2m = p_{n+1} - p_n$, where p_n is the n^{th} prime.

(3) Every number can be expressed as $N / d(N)$, where $d(N)$ is the number of divisors of N .

If $d(N)$ divides N we define $N / d(N) = I$ as the **index of beauty** for N .

The conjecture can be stated in other words as follows. For every natural number M there exists a number N such that M is the index of beauty for N . i.e. $M = N/d(N)$.

The conjecture is true for primes can be proved as follows:

We have $2 = 12 / d(12) = 12 / 6$, 2 is the index of beauty for 12.

$3 = 9 / d(9) = 9 / 3$, 3 is the index of beauty for 9.

For a prime $p > 3$ we have $N = 12p$, $d(N) = 12$ and $N / d(N) = p$.

($N = 8p$ can also be taken).

The conjecture is true for a large number of canonical forms can be established and further explored.

The proof for the general case or giving a counter example is still a challenging unsolved problem.

(4) If p is a prime there exist infinitely many primes of the form

A. $2^n p + 1$. (B) $2 \cdot a^n p + 1$.

(5) It is a well known fact that one can have arbitrarily large numbers of consecutive composite numbers.

i.e. $(r+1)! + 2$, $(r+1)! + 3$, $(r+1)! + 4$, ..., $(r+1)! + r - 1$, $(r+1)! + r$ give r consecutive composite numbers where r is chosen arbitrarily.

But these are not necessarily the smallest set of such numbers. Let us consider the smallest set of r consecutive composite numbers as follows

r	Smallest set of composite numbers	r / first composite number
1	1	1/1
2	8,9	2/8
3	14, 15, 16	3/14
4	24, 25, 26, 27	4/24
5	24, 25, 26, 27, 28	5/24
6	90, 91, 92, 93, 94, 95	6/90
7	90, 91, 92, 93, 94, 95, 96	7/90
8	114, 115, . . up to . . 121	8/114

Similarly for 9, 10, 11, 12, 13 the first of the composite numbers is 114.

We conjecture that the sum of the ratios in the third column is finite and $> e$.

(6) Given a number N . Carry out the following step of operation to get a number N_1

$$N - p_{r1} = N_1, \text{ where } p_{r1} < N < p_{r1+1}, p_{r1} \text{ is the } r_1^{\text{th}} \text{ prime.}$$

Repeat the above step to get N_2

$$N_1 - p_{r2} = N_2, \quad p_{r2} < N_1 < p_{r2+1}.$$

Go on repeating these steps till one gets $N_k = 0$ or 1.

The conjecture is (a) however large N be, $k < \log_2 \log_2 N$

(b) There exists a constant C such that $k < C$.

Open Problem: In case (b) is true, find the value of C .

THE REDUCED SMARANDACHE SQUARE-DIGITAL SUBSEQUENCE IS INFINITE

Maohua Le

Abstract . In this paper we prove that the reduced Smarandache square-digital subsequence is infinite.

Key words. reduced Smarandache square-digital subsequence, infinite.

Form all square integers $0, 1, 4, 9, 16, 25, 36, \dots$, we choose only the terms whose digits are all perfect squares and disregarding the square numbers of the form $N \cdot 10^{2t}$, where N is also a square number and t is a positive integer. Such sequence is called the reduced Smarandache square-digital subsequence . Bencze [1] and Smith [2] independently proposed the following question.

Question . How many terms in the reduced Smarandache square-digital subsequence?

In this paper we completely solve the mentioned question . We prove the following result.

Theorem . The reduced Smarandache square-digital subsequence has infinitely many terms.

By our theorem , we can give the following corollary immediately .

Corollary . The reduced Smarandache square-partial-digital subsequence has infinitely many terms.

Proof of Theorem . For any positive integer n , let

$$(1) \quad A(n) = 2 \cdot 10^n + 1.$$

Then we have

$$(2) (A(n))^2 = 4.102^n + 4.10^n + 1 = 4 \underbrace{0 \cdots 0}_{(n-1)\text{zeros}} 4 \underbrace{0 \cdots 0}_{(n-1)\text{zeros}} 1.$$

By (1) and (2), we see that $(A(n))^2$ belongs to the reduced Smarandache square—digital subsequence for any n thus, the sequence has infinitely many terms. The theorem is proved.

References

- [1] M. Bencze, Smarandache relationships and subsequences, Smarandache Notions J. 11(2000), 79 — 85.
- [2] S. Smith, A set of conjecture on Smarandache sequences, Bull. pure Appl. Sci. 16 E(1997), 2:237-240

Department of Mathematics
 Zhanjiang Normal College
 Zhanjiang, Guangdong
 P R CHINA

THE REDUCED SMARANDACHE CUBE-PARTIAL-DIGITAL SUBSEQUENCE IS INFINITE

Maohua Le

Abstract . In this paper we prove that the reduced Smarandache cube-partial-digital subsequence is infinite.

Key words . reduced Smarandache cube-partial-digital subsequence , infinite.

From all cube integers $0, 1, 8, 27, 64, 125, \dots$, we choose only the terms can be partitioned into groups of digits which are also perfect cubes and disregarding the cube numbers of the form $N \cdot 10^{3t}$, where N is also a cube number and t is a positive integer . Such sequence is called the reduced Smarandache cube-partial-digital subsequence . Bencze [1] and Smith [2] independently proposed the following question.

Question . How many terms in the reduced Smarandache cube-partial-digital subsequence?

In this paper we completely solve the mentioned question . We prove the following result.

Theorem . The reduced Smarandache cube-partial-digital subsequence has infinitely many terms.

Proof . For any positive integer n with $n > 1$, let

$$(1) \quad B(n) = 3 \cdot 10^n + 3.$$

Then we have

$$(2) \quad \begin{aligned} B(n)^3 &= 27 \cdot 10^{3n} + 81 \cdot 10^{2n} + 81 \cdot 10^n + 27 \\ &= 27 \underbrace{0 \dots 0}_{(n-2)\text{zeros}} 81 \underbrace{0 \dots 0}_{(n-2)\text{zeros}} 81 \underbrace{0 \dots 0}_{(n-2)\text{zeros}} 27. \end{aligned}$$

By (1) and (2) , we see that $(B(n))^3$ belongs to the reduced Smarandache cube-partial-digital subsequence . Thus , this sequence is infinite . The theorem is proved.

References

- [1] M. Bencze , Smarandache relationships and subsequence , Smarandache Notions J. 11(2000), 79-85.
- [2] S. Simth, A set conjectures on Smarandache sequences , Smarandache Notions J. 11(2000),86-92.

Department of Mathematics
Zhanjiang Normal College
Zhanjiang , Guangdong
P.R. CHINA

THE CONVERGENCE VALUE AND THE SIMPLE CONTINUED FRACTIONS OF SOME SMARANDACHE SEQUENCES

Maohua Le

Abstract . In this paper we consider the convergence value and the simple continued fraction of some Smarandache sequences.

Key words . Smarandache sequence , convergence value, simple continued fraction.

In [2] . Russo considered the convergence of the Smarandache series , the Smarandache infinite product and the Smarandache simple continued fractions for four Smarandache U -product sequences . Let $A=\{a(n)\}_{n=1}^{\infty}$ be a sequence of nonnegative numbers . In this paper we prove two general results as follows.

Theorem 1 . If $a(n)<a(n+1)$ for any n , then

$$\prod_{n=1}^{\infty} \frac{1}{a(n)} = \begin{cases} \infty , & \text{if } a(1)=0 , \\ 0 , & \text{if } a(1) \neq 0 . \end{cases}$$

Theorem 2 . If $a(n)>0$ for any n with $n>1$, then the simple continued fractions

$$a(1) + \frac{1}{a(2) + \frac{1}{a(3) + \dots}}$$

is convergent . Moreover , its value is an irrational number .

Proof of Theorem 1 . Under the assumption , the theorem is clear.

Proof of Theorem 2 . By [1, Theorems 161 and 166] ,

we obtain the theorem immediately .

Refernces

- [1] G. H. Hardy and E. M. Wright , An Introduction to the Theory of Numbers , Oxford University Press , Oxford , 1937 .
- [2] F. Russo , some results about four Smarandache U-product sequences, Smarandache Notions J. 11(2000), 42-49.

Department of Mathematics
Zhanjiang Normal College
Zhanjiang , Guangdong
P.R. CHINA

THE FIRST DIGIT AND THE TRAILING DIGIT OF ELEMENTS OF THE SMARANDACHE DECONSTRUCTIVE SEQUENCE

Maohua Le

Abstract . In this paper we completely determine the first digit and the trailing digit of every term in the Smarandache deconstructive sequence.

Key words . Smarandache deconstructive sequence , first digit , trailing digit.

The Smarandache deconstructive sequence is constructed by sequentially repeating the digits 1,2,...,9 in the following way :

$$(1) \quad 1,23,456,7891,\dots,$$

which first appeared in [1]. For any positive integer n , let $SDS(n)$ be the n -th element of the Smarandache deconstructive sequence . Further , let $F(n)$ and $T(n)$ denote the first digit and the trailing digit of $SDS(n)$ respectively . In this paper we completely determine $F(n)$ and $T(n)$ for any positive integer n . We prove the following result .

Theorem . For any n , we have

$$(2) \quad F(n) = \begin{cases} 1, & \text{if } n \equiv 0,1 \pmod{9}, \\ 2, & \text{if } n \equiv 2,5,8 \pmod{9}, \\ 4, & \text{if } n \equiv 3,7 \pmod{9}, \\ 7, & \text{if } n \equiv 4,6 \pmod{9}, \end{cases}$$

and

$$(3) \quad T(n) = \begin{cases} 1, & \text{if } n \equiv 1,4,7 \pmod{9}, \\ 3, & \text{if } n \equiv 2,6 \pmod{9}, \\ 6, & \text{if } n \equiv 3,5 \pmod{9}, \\ 9, & \text{if } n \equiv 0,8 \pmod{9}. \end{cases}$$

Proof. By (1), we get

$$(4) \quad F(n) \equiv 1+2+\cdots+(n-1)+1 \equiv \frac{n^2-n}{2} + 1 \pmod{9}.$$

let a be a positive integer with $1 \leq a \leq 9$. we see from (4) that $F(n)=a$ if and only if n is a solution of the congruence

$$(5) \quad \frac{n^2-n}{2} \equiv a-1 \pmod{9}.$$

Notice that (5) has only solutions

$$(6) \quad n \equiv \begin{cases} 0,1 \pmod{9}, & \text{if } a=1, \\ 2,5,8 \pmod{9}, & \text{if } a=2, \\ 3,7 \pmod{9}, & \text{if } a=4, \\ 4,6 \pmod{9}, & \text{if } a=7. \end{cases}$$

Therefore, we obtain (2) by (6) immediately.

On the other hand, since

$$(7) \quad T(n) = \begin{cases} F(n+1), & \text{if } F(n+1) > 1, \\ 9, & \text{if } F(n+1) = 1, \end{cases}$$

we see from (2) that (3) holds. Thus, the theorem is proved.

Reference

- [1] F. Smarandache, Only Problems, Not Solutions, Xiquan Publishing House, Phoenix, Arizona, 1993.

Department of Mathematics
Zhanjiang Normal College
Zhanjiang, Guangdong
P.R. CHINA

THE 2-DIVISIBILITY OF EVEN ELEMENTS OF THE SMARANDACHE DECONSTRUCTIVE SEQUENCE

Maohua Le

Abstract . In this paper we prove that if $n > 5$ and $SDS(n)$ is even, then $SDS(n)$ is exactly divisible by 2^7 .

Key words . Smarandache deconstructive sequence , 2-divisibility .

The Smarandache deconstructive sequence is constructed by sequentially repeating the digits 1,2, ..., 9 in the following way :

(1) 1,23,456,7891, ...,

which first appeared in [3] . For any positive integer n , let $SDS(n)$ denote the n -th element of the Smarandache deconstructive sequence . In [1] , Ashbacher considered the values of the first thirty elements of this sequence . He showed that $SDS(3) = 456$ is divisible by 2^3 , $SDS(5) = 23456$ by 2^5 and all others by 2^7 . Therefore , Ashbacher proposed the following question.

Question . If we form a sequence from the elements $SDS(n)$ which the trailing digits are 6, do the powers of 2 that divide them form a monotonically increasing sequence ?

In this paper we completely solve the mentioned question . We prove the following result.

Theorem . If $n > 5$ and $SDS(n)$ is even , then $SDS(n)$ is exactly divisible by 2^7 .

Proof . By the result of [2], if $SDS(n)$ is even , then the trailing digit of it must be 6 . Moreover , if $n > 5$,

then $n \geq 12$. Therefore, by (1), if $n > 5$ and $SDS(n)$ is even, then we have

$$(2) \quad SDS(n) = 89123456 + k \cdot 10^8,$$

where k is a positive integer. Notice that $2^8 \mid 10^8$ and $2^7 \nmid 89123456$. We see from (2) that $2^7 \nmid SDS(n)$. Thus, the theorem is proved.

References

- [1] C. Ashbacher, Some problems concerning the Smarandache Deconstructive sequence, *Smarandache Notions J.* 11(2000), 120-122.
- [2] M.-H. Le, The first digit and the trailing digit of elements of the Smarandache deconstructive sequence, *Smarandache Notions J.* to appear.
- [3] F. Smarandache, *only problems, Not Solutions*, Xiquan Publishing House, Phoenix, Arizona, 1993.

Department of Mathematics
Zhanjiang Normal College
Zhanjiang, Guangdong
P.R. CHINA

TWO SMARANDACHE SERIES

Maohua Le

Abstract . In this paper we consider the convergence for two Smarandache series .

Key words . Smarandache reciprocal series , convergence .

Let $A = \{a(n)\}_{n=1}^{\infty}$ and $B = \{b(n)\}_{n=1}^{\infty}$ be two Smarandache sequences . Then the series

$$S(A,B) = \sum_{n=1}^{\infty} \frac{a(n)}{b(n)}$$

is called the Smarandache series of A and B . Recently , Castillo [1] proposed the following two open problems .

Problem 1 . Is the series

$$(1) \quad S_1 = \frac{1}{1} + \frac{1}{12} + \frac{1}{123} + \frac{1}{1234} + \dots$$

convergent ?

Problem 2 . Is the series

$$(2) \quad S_2 = \frac{1}{1} + \frac{12}{21} + \frac{123}{321} + \frac{1234}{4321} + \dots$$

Convergent ?

In this paper we completely solve the mentioned problems as follows .

Theorem . The series S_1 is convergent and the series S_2 is divergent .

Proof . Let $r(n) = 1/12 \cdots n$ for any positive integer n .
Since

$$(3) \quad \lim_{n \rightarrow \infty} \frac{r(n+1)}{r(n)} = \frac{12 \cdots n}{12 \cdots n(n+1)} < 1,$$

by D'Alembert's criterion, we see from (3) that S_1 is convergent.

Let $s(n) = 12 \cdots (n-1)n / n(n-1) \cdots 21$ for any positive integer n . If $n = 10^t + 1$, where t is a positive integer, then we have

$$(4) \quad S(n) = \frac{12 \cdots (10 \cdots 01)}{(10 \cdots 01) \cdots 21} > 1.$$

Therefore, by (4), we get from (2) that

$$(5) \quad S_2 = \sum_{n=1}^{\infty} s(n) > \sum_{t=1}^{\infty} s(10^t + 1) > \sum_{t=1}^{\infty} 1 = \infty.$$

Thus, the series S_2 is divergent. The theorem is proved.

Reference

- [1] J. Castillo, Smarandache series, Smarandache Notions J.,
<http://www.gallup.unm.edu/~smarandache/SERIES.TXT>.

Department of Mathematics
 Zhanjiang Normal College
 Zhanjiang, Guangdong
 P.R. CHINA

THE 3-DIVISIBILITY OF ELEMENTS OF THE SMARANDACHE DECONSTRUCTIVE SEQUENCE

Maohua Le

Abstract . For any positive integer n , let $SDS(n)$ be the n -th element of the Smarandache deconstructive sequence . In this paper we prove that if $3^k \parallel n$, then $3^k \parallel SDS(n)$.

Key words . Smarandache deconstructive sequence , 3-divisibility .

The Smarandache deconstructive sequence is constructed by sequentially repeating the digits 1,2, ...,9 in the following way :

$$(1) \quad 1,23,456,7891,\dots,$$

which first appeared in [3] . For any positive integer n , let $SDS(n)$ denote the n -th element of this sequence . In [1] , Ashbacher showed that $3 \mid SDS(n)$ if and only if $3 \mid n$. Simultaneously , he proposed the following question .

Question . Let k be the largest integer such that $3^k \mid n$. Is it true that

$$(2) \quad 3^k \parallel SDS(n) ?$$

In this paper we completely solve the mentioned question . We prove the following result.

Theorem . If $3^k \parallel n$, then (2) holds.

Proof . By [1, Table1], the theorem holds for $n \leq 30$. Therefore, we may assume that $n > 30$. If $3^k \parallel n$, then

$$(3) \quad n=3^k m,$$

where m is a positive integer with $3 \mid m$.

By the result of [2], If $k=1$, then we have

$$(4) SDS(n) = \begin{cases} 456789 \cdot 10^a + 123456788889^b + 123456, & \text{if } n \equiv 3 \pmod{9}, \\ 789 \cdot 10^a + 123456789^b + 123, & \text{if } n \equiv 6 \pmod{9}, \end{cases}$$

where a, b are positive integers. Since $10^a \equiv 1 \pmod{9}$ and $123456789 \equiv 0 \pmod{9}$, we find from (4) that

$$(5) \quad SDS(n) \equiv \begin{cases} 6 \pmod{9}, & \text{if } n \equiv 3 \pmod{9}, \\ 3 \pmod{9}, & \text{if } n \equiv 6 \pmod{9}. \end{cases}$$

Thus, by (5), we get $3 \parallel SDS(n)$. The theorem holds for $k=1$,

If $k > 1$, let.

$$(6) \quad n = 9t,$$

where t is a positive integer. By (3) and (6), we get

$$(7) \quad 3^{k-2} \parallel t.$$

Then, by the result of [2], we have

$$(8) \quad \begin{aligned} SDS(n) &= 123456789(1 + 10^9 + \dots + 10^{9(t-1)}) \\ &= 123456789 \left[\frac{10^{9t} - 1}{10^9 - 1} \right]. \end{aligned}$$

Notice that $3^2 \parallel 123456789$ and $3^{k-2} \parallel (10^{9t} - 1)/(10^9 - 1)$ by (7). We see from (8) that (2) holds. Thus, the theorem is proved.

References

- [1] C. Ashbacher, Some problems concerning the Smarandache deconstructive sequence, Smarandache Notions J. 11(2000), 120-122.
- [2] M.-H. Le, The first digit and the trailing digit of elements of the Smarandache deconstructive sequence,

Smarandache Notions J. , 12(2001).

- [3] F. Smarandache , Only problems , Not Solutions , Xiquan Publishing House , Phoenix , Arizona , 1993.

Department of Mathematics
Zhanjiang Normal College
Zhanjiang , Guangdong
P.R. CHINA

TWO CONJECTURES CONCERNING EXTENTS OF SMARANDACHE FACTOR PARTITIONS

Maohua Le

Abstract . In this paper we verify two conjectures concerning extents of Smarandache factor partitions .

Key words . Smarandache factor partition , sum of length .

Let p_1, p_2, \dots, p_n be distinct primes , and let a_1, a_2, \dots, a_n be positive integers . Further , let

$$(1) \quad t = p_1^{a_1} p_2^{a_2} \cdots p_n^{a_n} ,$$

and let $F(a_1, a_2, \dots, a_n)$ denote the number of ways in which t could be expressed as the product of its divisors . Furthermore , let

$$(2) \quad F(1\#n) = F(\underbrace{1, 1, \dots, 1}_{n \text{ ones}}) .$$

If d_1, d_2, \dots, d_r are divisors of t and

$$(3) \quad t = d_1 d_2 \cdots d_r ,$$

then (3) is called a Smarandache factor partition representation with length r . Further , let $\text{Extent}(F(1\#n))$ denote the sum of lengths of all Smarandache factor partition representations of $p_1 p_2 \cdots p_n$. In [2] , Murthy proposed the following two conjectures .

Conjecture 1 .

$$(4) \quad \text{Extent}(F(1\#n)) = F(1\#(n+1)) - F(1\#n) .$$

Conjecture 2 .

$$(5) \quad \sum_{k=0}^n \text{Extent}(F(1\#n)) = F(1\#(n+1)).$$

In this paper we verify the mentioned conjectures as follows.

Theorem. For any positive integer n , the identities (4) and (5) are true.

Proof. Let $Y(n)$ be the n -th Bell number. By the definitions of $F(1\#n)$ and $Y(n)$ (see [1]), we have

$$(6) \quad F(1\#n) = Y(n).$$

Let $L(r)$ be the number of Smarandache factor partitions of $p_1 p_2 \dots p_n$ with length r . Then we have

$$(7) \quad L(r) = S(n, r),$$

where $S(n, r)$ is the Stirling number of the second kind with parameters n and r . Since

$$(8) \quad Y(n) = \sum_{r=1}^n S(n, r),$$

by (6), (7) and (8), we get

$$(9) \quad F(1\#n) = Y(n) = \sum_{r=1}^n S(n, r)$$

and

$$(10) \quad \text{Extent} F(1\#n) = \sum_{r=1}^n r S(n, r).$$

It is a well known fact that

$$(11) \quad r S(n, r) = S(n+1, r) - S(n, r-1),$$

for $n \geq r \geq 1$ (see [1]). Notice that $S(n, n) = 1$. Therefore, by (9), (10) and (11), we obtain

$$\begin{aligned}
& \text{Extent}(F(1\#n)) = \sum_{r=1}^n (S(n+1,r) - S(n,r-1)) \\
(12) \quad & = \sum_{r=1}^n S(n+1,r) - \sum_{r=1}^n S(n,r-1) = (Y(n+1)) - S(n+1,n+1) \\
& \quad - (Y(n) - S(n,n)) = Y(n+1) - Y(n) = F(1\#(n+1)) - F(1\#n).
\end{aligned}$$

It implies that (4) holds.

On the other hand, we get from (4) that

$$\begin{aligned}
& \sum_{k=0}^n \text{Extent}(F(1\#k)) = 1 + \sum_{r=1}^n \text{Extent}(F(1\#r)) \\
(13) \quad & = \sum_{r=1}^n (F(1\#(r+1)) - F(1\#r)) = F(1\#(n+1)).
\end{aligned}$$

Thus, (5) is also true. The theorem is proved.

References

- [1] C. Jordan, Calculus of Finite Differences, Chelsea, 1965.
- [2] A. Murthy, Length/extent of Smarandache factor partitions, Smarandache Notions J. 11(2000), 275-279.

Department of Mathematics
Zhanjiang Normal College
Zhanjiang, Guangdong
P.R. CHINA

ON THE BALU NUMBERS

Maohua Le

Abstract . In this paper we prove that there are only finitely many Balu numbers .

Key words . Smarandache factor partition , number of divisors , Balu number , finiteness .

1.Introductio

For any positive integer n , let $d(n)$ and $f(n)$ be the number of distinct divisors and the Smarandache factor partitions of n respectively. If n is the least positive integer satisfying

$$(1) \quad d(n)=f(n)=r$$

for some fixed positive integers r , then n is called a Balu number. For example , $n=1,16,36$ are Balu numbers. In [4], Murthy proposed the following conjecture.

Conjecture. There are finitely many Balu numbers.

In this paper we completely solve the mentioned question. We prove the following result .

Theorem. There are finitely many Balu numbers .

2.Preliminaries

For any positive integer n with $n>1$, let

$$(2) \quad n = p_1^{a_1} p_2^{a_2} \dots p_k^{a_k}$$

be the factorization of n .

Lemma 1 ([1, Theorem 273]) . $d(n)=(a_1+1)(a_2+1)\dots(a_k+1)$.

Lemma 2. Let a, p be positive integers with $p > 1$, and let

$$(3) \quad b = \left[\frac{1}{2} \sqrt{1+8a} - \frac{1}{2} \right].$$

Then p^a can be written as a product of b distinct positive integers

$$(4) \quad p^a = p \cdot p^2 \cdots p^{b-1} p^{a-b(b-1)/2}.$$

Proof. We see from (3) that $a \geq 1+2+\dots+(b-1)+b$. Thus, the lemma is true.

Lemma 3. For any positive integer m , let $Y(m)$ be the m -th Bell number. Then we have

$$(5) \quad f(n) \geq Y(c),$$

where

$$(6) \quad c = b_1 + b_2 + \dots + b_k$$

and

$$(7) \quad b_i = \left[\frac{1}{2} \sqrt{1+8a_i} - \frac{1}{2} \right], \quad i=1,2,\dots,k.$$

Proof. Since p_1, p_2, \dots, p_k are distinct primes in the factorization (2) of n , by Lemma 2, we see from (6) and (7) that n can be written as a product of c distinct positive integers

$$(8) \quad n = \prod_{i=1}^k \left[p_i^{a_i - b_i(b_i-1)/2} \prod_{j=1}^{b_i-1} p_i^j \right].$$

Therefore, by (6) and (8), we get

$$(9) \quad f(n) \geq F(1\#c),$$

where $F(1\#c)$ is the number of Smarandache factor partitions of a product of c distinct primes. Further, by [2, Theorem], we have

$$(10) \quad F(1\#c) = Y(c).$$

Thus, by (9) and (10), we obtain (5). The lemma is

proved .

Lemma 4 ([3]) . $\log Y(m) \sim m \log m$.

3.Proof of Theorem

We now suppose that there exist infinitely many Balu numbers . Let n be a Balu number , and let (2) be the factorization of n . Further , let

$$(11) \quad a = a_1 + a_2 + \dots + a_k .$$

Clear , if n is enough large , then a tends to infinite . Moreover , since

$$(12) \quad b_i \geq \sqrt{a} \quad i = 1, 2, \dots, k ,$$

by (7) , we see from (6) that c tends to infinite too . Therefore , by Lemmas 1 , 3 and 4 , we get from (1), (2), (6) and (12) that

$$(13) \quad 1 = \frac{\log d(n)}{\log f(n)} \leq \frac{\sum_{i=1}^k \log(a_i+1)}{\left(\sum_{i=1}^k \sqrt{a_i} \right) \left(\log \sum_{i=1}^k \sqrt{a_i} \right)}$$

$$\leq \frac{\sum_{i=1}^k \log(a_i+1)}{k \sum_{i=1}^k \sqrt{a_i}} < 1 ,$$

a contradiction . Thus , there are finitely many Balu numbers . The theorem is proved .

References

- [1] G. H. Hardy and E. M. Wright, An Introduction to the Theory of Numbers, Oxford University Press, Oxford, 1937.
- [2] M.-H. Le, Two conjectures concerning extents of Smarandache factor partitions, Smarandache Notions J., 12(2001).
- [3] L. Moser and M. Wyman, An asymptotic formula for the Bell numbers, Trans. Roy. Soc. Canada 49 (1955), 49-54.
- [4] A. Murthy, Open problems and conjectures on the factor/reciprocal partition theory, Smarandache Notions J. 11(2000), 308-311.

Department of Mathematics
Zhanjiang Normal College
Zhanjiang, Guangdong
P.R. CHINA

THE LIMIT OF THE SMARANDACHE DIVISOR SEQUENCES

Maohua Le

Abstract. In this paper we prove that the limit $T(n)$ of the Smarandache divisor sequence exists if and only if n is odd.

Key words. Smarandache divisor sequence, limit, existence.

For any positive integers n and x , let the set
 (1) $A(n) = \{x \mid d(x) = n\}$,
 where $d(x)$ is the number of distinct divisors of x .
 Further, let

$$(2) \quad T(n) = \sum_x \frac{1}{x},$$

where the summation sign \sum denote the sum through over all elements x of $A(n)$. In [2], Murthy showed that $T(n)$ exists if $n=1$ or n is an odd prime, but $T(2)$ does not exist. Simultaneous, Murthy asked that whether $T(n)$ exist for $n=4,6$ etc. In this paper we completely solve the mentioned problem. We prove a general result as follows.

Theorem. $T(n)$ exists if and only if n is odd.

Proof. For any positive integer a with $a > 1$, let

$$(3) \quad a = p_1^{r_1} p_2^{r_2} \dots p_k^{r_k}$$

be the factorization of a . By [1, Theorem 27], we have

$$(4) \quad d(a) = (r_1 + 1)(r_2 + 1) \dots (r_k + 1).$$

If n is even, then from (1) and (4) we see that

$A(n)$ contains all positive integers x with the form

$$(5) \quad x = pq^{n/2-1},$$

where p, q are distinct primes. Therefore, we get from (2) and (5) that

$$(6) \quad T(n) > \frac{1}{2^{n/2-1}} \sum^* \frac{1}{p} = \frac{1}{2^{n/2-1}} [T(2) - 2],$$

where the summation sign \sum^* denote the sum through over all odd primes p . Since $T(2)$ does not exist, we find from (6) that $T(n)$ does not exist if n is even.

Let

$$(7) \quad n = d_1 d_2 \cdots d_t$$

be a multiplicative partition of n , where d_1, d_2, \dots, d_t are divisors of n with $1 < d_1 \leq d_2 \leq \dots \leq d_t$. Further, let

$$(8) \quad T(d_1 d_2 \cdots d_t) = \{x \mid x = p_1^{d_1-1} p_2^{d_2-1} \cdots p_t^{d_t-1}, p_1, p_2, \dots, p_t \text{ are distinct primes}\}.$$

By (1), (4), (7) and (8), we get

$$(9) \quad T(n) = \sum^{**} T(d_1 d_2 \cdots d_t),$$

where the summation sign \sum^{**} denote the sum through over all distinct multiplicative partitions of n . For any positive integer m , let

$$(10) \quad R(m) = \sum_{k=1}^{\infty} \frac{1}{k^m}$$

be the Riemann function. If n is odd, then from (7) we see that $d_1 \geq 3$. Therefore, by (4), (8), (9) and (10), we obtain

$$(11) \quad \begin{aligned} T(n) &< \sum^{**} \left[\prod_{i=1}^t \left[\frac{1}{2^{d_i-1}} \sum^* \frac{1}{p^{d_i-1}} \right] \right] \\ &< \sum^{**} \left[\prod_{i=1}^t R(d_i-1) \right] \leq \sum^{**} \left[\prod_{i=1}^t R(2) \right] \\ &= \sum^{**} [R(2)]^t. \end{aligned}$$

Since the number of multiplicative partitions of n is finite and $R(2) = \pi^2/6$, we see from (11) that $T(n)$ exists if n is odd. Thus, the theorem is proved.

References

- [1] G.H. Hardy and E.M. Wright, An Introduction to the Theory of Numbers, Oxford University press, Oxford, 1937.
- [2] A.Murthy, Some new Smarandache sequences, functions and partitions, Smarandache Notions J. 11(2000), 179-185.

Department of Mathematics
Zhanjiang Normal College
Zhanjiang, Guangdong
P.R. CHINA

A GENERALIZED NET FOR MACHINE LEARNING OF THE PROCESS OF MATHEMATICAL PROBLEMS SOLVING

On an Example with a Smarandache Problem

Krassimir Atanassov and Hristo Aladjov

CLBME - Bulg. Academy of Sci., P.O.Box 12, Sofia-1113, Bulgaria

e-mails: {krat, aladjov}@bgcict.acad.bg

The authors of the present paper prepared a series of research related to the ways of representation by Generalized nets (GNs, see [1] and the Appendix) the process of machine learning of different objects, e.g., neural networks, genetic algorithms, GNs, expert systems, systems (abstract, statical, dynamical, stohastical and others), etc. Working on their research [2], where they gave a counterexample of the 62-nd Smarandache's problem (see [3]), they saw that the process of the machine learning of the process of the mathematical problems solving also can be described by a GN and by this reason the result form [2] was used as an example of the present research. After this, they saw that the process of solving of a lot of the Smarandache's problems can be represented by GNs in a similar way and this will be an object of next their research.

The GN (see [1] and the Appendix), which is described below have three types of tokens α -, β - and γ - tokens. They interpret respectively the object which will be studied, its known property (properties) and the hypothesis, related to it, which must be checked. The tokens' initial characteristics correspond to these interpretations. The tokens enter the GN, respectively, through places

- l_1 with the initial characteristic "description of the object" (if we use the example from [2], this characteristic will be, e.g., "sequence of natural numbers"),
- l_2 with the initial characteristic "property (properties) of the object, described as an initial characteristic of α -token corresponding to the present β -token" (in the case of the example mentioned above, it will be the following property "there are no three elements of the sequence, which are members of an arithmetic progression") and
- l_3 with the initial characteristic "description of an hypothesis about the object" (for the discussed example this characteristic will be, e.g., "the sum of the reciprocal values of the members of the sequence are smaller than 2").

We shall would like for the places' priorities to satisfy the following inequalities:

$$\pi_L(l_1) > \pi_L(l_2) > \pi_L(l_3),$$

$$\pi_L(l_7) > \pi_L(l_4) > \pi_L(l_6) > \pi_L(l_5),$$

The GN transitions (see [1] and the Appendix) have the following forms:

$$Z_1 = \langle \{l_1, l_2, l_3, l_{21}, l_{23}, l_{25}\}, \{l_4, l_5, l_6\}, r_1, M_1, \square_1 \rangle,$$

where

$$r_1 = \begin{array}{c|ccc} & l_4 & l_5 & l_6 \\ \hline l_1 & true & false & false \\ l_2 & false & true & false \\ l_3 & false & false & true \\ l_{21} & true & false & false \\ l_{23} & false & true & false \\ l_{25} & false & false & true \end{array} ,$$

$$M_1 = \begin{array}{c|ccc} & l_4 & l_5 & l_6 \\ l_1 & 1 & 0 & 0 \\ l_2 & 0 & 1 & 0 \\ l_3 & 0 & 0 & 1 \\ l_{21} & 1 & 0 & 0 \\ l_{23} & 0 & 1 & 0 \\ l_{25} & 0 & 0 & 1 \end{array},$$

$$kv_1 = \wedge(\vee(l_1, l_{21}), \vee(l_2, l_{23}), \vee(l_3, l_{25})).$$

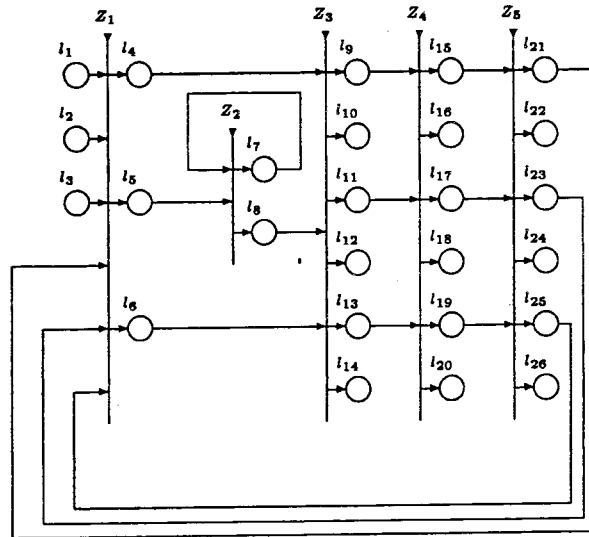

The α -token obtains the characteristic “the initial status of the object, having in mind the current γ -characteristic” in place l_4 , the β -token obtains the characteristic “a next state of the object, having in mind the current α - and γ -characteristics” in place l_5 , and the γ -token obtains the characteristics “restrictions over the object, having in mind its property (properties) from the initial β -characteristic in place l_6 . For the discussed example with the 62-nd Smarandache’s problem, the last three characteristics have the following forms, respectively: “1, 2” (initial values of the sequence); “3” (next value of the sequence); e.g., “the members to be minimal possible”.

$$Z_2 = \langle \{l_5, l_7\}, \{l_7, l_8\}, r_2, M_2, \vee(l_5, l_7) \rangle,$$

where

$$r_2 = \begin{array}{c|cc} & l_7 & l_8 \\ l_5 & r_{5,7} & r_{5,8} \\ l_7 & r_{7,7} & r_{7,8} \end{array}$$

where

$r_{5,7} = r_{7,7}$ = “the new state of the object does not satisfy the property of the object determined by the initial β -characteristic”

$r_{5,8} = r_{7,8} = \neg r_{5,7}$. and

$$M_3 = \begin{array}{c|cc} & l_7 & l_8 \\ l_5 & 1 & 1 \\ l_7 & 1 & 1 \end{array}.$$

The β -token obtains the characteristic "a next state of the object, having in mind the current α - and γ -characteristics" in place l_7 and it does not obtain any characteristic in place l_8 . In the case of our example, on the first time, when the β -token enters place l_7 will obtain the characteristic "4".

$$Z_3 = \langle \{l_4, l_6, l_8\}, \{l_9, l_{10}, l_{11}, l_{12}, l_{13}, l_{14}\}, r_3, M_3, \square_3, \rangle$$

where

$$r_3 = \begin{array}{c|cccccc} & l_9 & l_{10} & l_{11} & l_{12} & l_{13} & l_{14} \\ \hline l_4 & r_{4,9} & r_{4,10} & \text{false} & \text{false} & \text{false} & \text{false} \\ l_6 & \text{false} & \text{false} & r_{6,11} & r_{6,12} & \text{false} & \text{false} \\ l_8 & \text{false} & \text{false} & \text{false} & \text{false} & r_{8,13} & r_{8,14} \end{array},$$

where

$$r_{4,9} = r_{6,11} = r_{8,13} = \text{"the new state is not a final one"},$$

$$r_{4,10} = r_{6,12} = r_{8,14} = \neg r_{4,9},$$

$$M_3 = \begin{array}{c|cccccc} & l_9 & l_{10} & l_{11} & l_{12} & l_{13} & l_{14} \\ \hline l_4 & 1 & 1 & 0 & 0 & 0 & 0 \\ l_6 & 0 & 0 & 1 & 1 & 0 & 0 \\ l_8 & 0 & 0 & 0 & 0 & 1 & 1 \end{array},$$

$$\square_3 = \wedge(l_4, l_6, l_8).$$

The α -token does not obtain any characteristic in place l_9 , and it obtains the characteristic "the list of all states of the object" in place l_{10} ; the β -token does not obtain any characteristic in places l_{11} and l_{12} ; the γ -token does not obtain any characteristic in place l_{13} , and it obtains the characteristic

$$\left\{ \begin{array}{ll} \text{"the hypothesis is valid by the present step"}, & \text{if the last state of the object} \\ & \text{satisfies the hypothesis} \\ \text{"the hypothesis is not valid by the present step"}, & \text{if the last state of the object does} \\ & \text{not satisfy the hypothesis} \end{array} \right.$$

in place l_{14} . For the discussed example with the 62-nd Smarandache's problem, the tokens do not obtain any characteristics.

$$Z_4 = \langle \{l_9, l_{11}, l_{13}\}, \{l_{15}, l_{16}, l_{17}, l_{18}, l_{19}, l_{20}\}, r_4, M_4, \square_4, \rangle$$

where

$$r_4 = \begin{array}{c|cccccc} & l_{15} & l_{16} & l_{17} & l_{18} & l_{19} & l_{20} \\ \hline l_9 & r_{9,15} & r_{9,16} & \text{false} & \text{false} & \text{false} & \text{false} \\ l_{11} & \text{false} & \text{false} & r_{11,17} & r_{11,18} & \text{false} & \text{false} \\ l_{13} & \text{false} & \text{false} & \text{false} & \text{false} & r_{13,19} & r_{13,20} \end{array},$$

where

$$r_{9,15} = r_{11,17} = r_{13,19} = \text{"the hypothesis is valid"},$$

$$r_{9,16} = r_{11,18} = r_{13,20} = \neg r_{9,15},$$

$$M_4 = \begin{array}{c|cccccc} & l_{15} & l_{16} & l_{17} & l_{18} & l_{19} & l_{20} \\ \hline l_9 & 1 & 1 & 0 & 0 & 0 & 0 \\ l_{11} & 0 & 0 & 1 & 1 & 0 & 0 \\ l_{13} & 0 & 0 & 0 & 0 & 1 & 1 \end{array},$$

$$\square_4 = \wedge(l_9, l_{11}, l_{13}).$$

The α -token does not obtain any characteristic in place l_{15} , and it obtains the characteristic “the final state, which violate the hypothesis” in place l_{16} ; the β -token does not obtain any characteristic in places l_{17} and l_{18} ; the γ -token does not obtain any characteristic in place l_{19} , and it obtains the characteristic “the hypothesis is not valid” in place l_{20} . For the discussed example with the 62-nd Smarandache’s problem, the tokens do not obtain any characteristics.

$$Z_5 = \langle \{l_{15}, l_{17}, l_{19}\}, \{l_{21}, l_{22}, l_{23}, l_{24}, l_{25}, l_{26}\}, \tau_5, M_5, \square_5, \rangle$$

where

	l_{21}	l_{22}	l_{23}	l_{24}	l_{25}	l_{26}
l_{15}	$r_{15,21}$	$r_{15,22}$	false	false	false	false
l_{17}	false	false	$r_{17,23}$	$r_{17,24}$	false	false
l_{19}	false	false	false	false	$r_{19,25}$	$r_{19,26}$

where

$r_{15,21} = r_{17,23} = r_{19,25} =$ ”there is a possibility for a change of the restrictions over the object, which evolve from the hypothesis”,

$r_{15,22} = r_{17,24} = r_{19,26} = \neg r_{15,21}$,

	l_{21}	l_{22}	l_{23}	l_{24}	l_{25}	l_{26}
l_{15}	1	1	0	0	0	0
l_{17}	0	0	1	1	0	0
l_{19}	0	0	0	0	1	1

$$\square_3 = \wedge(l_{15}, l_{17}, l_{19}).$$

The α -token obtains as its current characteristic its initial characteristic in place l_{21} , and it does not obtain any characteristic in place l_{22} ; the β -token obtains as its current characteristic its initial characteristic in place l_{23} and it does not obtain any characteristic in place l_{24} ; the γ -token obtains the characteristic “new restrictions over the object” in place l_{25} , and it does not obtain any characteristic in place l_{26} . For the discussed example with the 62-nd Smarandache’s problem, the tokens do not obtain any characteristics in places $l_{21}, l_{22}, l_{23}, l_{24}$ and l_{26} , and the γ -token will obtain as a characteristic “1,3” l_{25} . These two numbers will be initial for the next search of a sequence, which satisfy the hypothesis. In the next step they will be changed, e.g., by numbers 2 and 3, etc.

Using this scheme, it is possible to describe the process of solving of some of the other Smarandache’s problems, too, e.g., problems ... from [3].

APPENDIX: Short remarks on Generalized Nets (GNs)

The concept of a *Generalized Net* (GN) is described in details in [1], see also

www.daimi.aau.dk/PetriNets/bibl/aboutpnbibl.html

They are essential extensions of the ordinary Petri nets. The GNs are defined in a way that is principally different from the ways of defining the other types of Petri nets. When some of

the GN-components of a given model are not necessary, they can be omitted and the new nets are called reduced GNs. Here a reduced GN without temporal components is used.

Formally, every transition (or the used form of reduced GN) is described by a five-tuple:

$$Z = \langle L', L'', r, M, \square \rangle,$$

where:

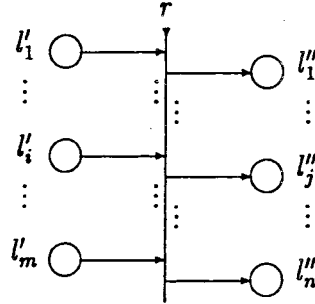

(a) L' and L'' are finite, non-empty sets of places (the transition's input and output places, respectively); for the above transition these are

$$L' = \{l'_1, l'_2, \dots, l'_m\}$$

and

$$L'' = \{l''_1, l''_2, \dots, l''_n\};$$

(b) r is the transition's *condition* determining which tokens will pass (or *transfer*) from the transition's inputs to its outputs; it has the form of an Index Matrix (IM; see [1]):

$$r = \begin{array}{c|ccc} & l''_1 & \dots & l''_j & \dots & l''_n \\ \hline l'_1 & & & & & \\ \vdots & & & & & \\ l'_i & & & r_{i,j} & & \\ \vdots & & & (r_{i,j} - \text{predicate}) & & \\ l'_m & & & (1 \leq i \leq m, 1 \leq j \leq n) & & \end{array} ;$$

$r_{i,j}$ is the predicate which corresponds to the i -th input and j -th output places. When its truth value is "true", a token from the i -th input place can be transferred to the j -th output place; otherwise, this is not possible;

(c) M is an IM of the capacities of transition's arcs:

$$M = \begin{array}{c|ccc} & l''_1 & \dots & l''_j & \dots & l''_n \\ \hline l'_1 & & & & & \\ \vdots & & & & & \\ l'_i & & & m_{i,j} & & \\ \vdots & & & (m_{i,j} \geq 0 - \text{natural number}) & & \\ l'_m & & & (1 \leq i \leq m, 1 \leq j \leq n) & & \end{array} ;$$

(d) \square is an object having a form similar to a Boolean expression. It may contain as variables the symbols which serve as labels for transition's input places, and is an expression

built up from variables and the Boolean connectives \wedge and \vee , with semantics defined as follows:

- $\wedge(l_{i_1}, l_{i_2}, \dots, l_{i_n})$ – every place $l_{i_1}, l_{i_2}, \dots, l_{i_n}$ must contain at least one token,
 $\vee(l_{i_1}, l_{i_2}, \dots, l_{i_n})$ – there must be at least one token in all places $l_{i_1}, l_{i_2}, \dots, l_{i_n}$, where $\{l_{i_1}, l_{i_2}, \dots, l_{i_n}\} \subset L'$.

When the value of a type (calculated as a Boolean expression) is “true”, the transition can become active, otherwise it cannot.

The object

$$E = \langle A, \pi_L, K, X, \Phi \rangle$$

is called a (reduced) GN, if

- (a) A is a set of transitions;
- (b) π_L is a function giving the priorities of the places, i.e., $\pi_L : L \rightarrow N$, where $L = pr_1 A \cup pr_2 A$, and $pr_i X$ is the i -th projection of the n -dimensional set, where $n \in N, n \geq 1$ and $1 \leq k \leq n$ (obviously, L is the set of all GN-places);
- (c) K is the set of the GN's tokens;
- (d) X is the set of all initial characteristics the tokens can receive when they enter the net;
- (e) Φ is a characteristic function which assigns new characteristics to every token when it makes the transfer from an input to an output place of a given transition.

REFERENCES:

- [1] Atanassov K., Generalized Nets, World Scientific, Singapore, New Jersey, London, 1991.
- [2] Aladjov H., Atanassov K., Remark on the 62-th Smarandache's problem. Smarandache Notions Journal, Vol. 11, No. 1-2-3, 2000, 69-70.
- [3] Smarandache F., Only Problems, Not Solutions!. Xiquan Publ. House, Chicago, 1993.

NEW SMARANDACHE ALGEBRAIC STRUCTURES

*G.L. WAGHMARE & S.V. MORE

ABSTRACT

Generally in R^3 any plane with equation $x + y + z = a$, where a is nonzero number, is not a linear space under the usual vector addition and scalar multiplication. If we define new algebraic operations on the plane $x + y + z = a$ it will become a linear space in R^3 . The additive identity of this linear space has nonzero components.

1. The plane $x + y + z = a$ touches the x -axis at point $A (a, 0, 0)$, y -axis at point $B (0, a, 0)$ and z -axis at point $C (0, 0, a)$. Take triangle ABC as a fixed equilateral triangle known as "triangle of reference."

From any point P in its plane draw perpendiculars PM , PN and PL to AC , AB and BC respectively. Let $\perp(PM) = p_1$, $\perp(PN) = p_2$ and $\perp(PL) = p_3$. These p_1 , p_2 and p_3 are called the trilinear coordinator of point P [Loney 1, Smith 2, Sen 3].

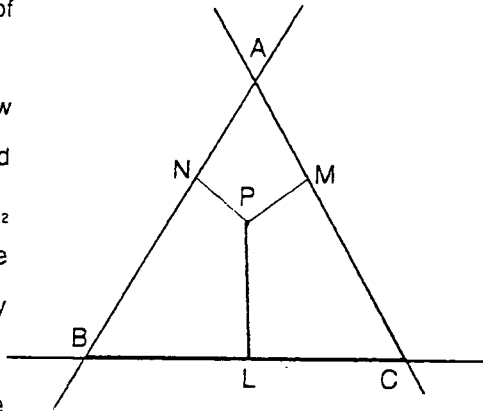

The coordinate p_1 is positive if P and the vertex B of the triangle are on the same side of AC and p_1 is negative if P and B are on the opposite sides of AC . So for the other coordinates p_2 and p_3 .

2. Length of each side of the triangle is $\sqrt{2} |a| = b$ (say).
 $1/2 \cdot b \cdot p_1 + 1/2 \cdot b \cdot p_2 + 1/2 \cdot b \cdot p_3 = 1/2 b \cdot \sqrt{3} / 2 \cdot b$

$$p_1 + p_2 + p_3 = \sqrt{3} / 2 \cdot b = k \text{ (say).}$$

The trilinear coordinates p_1 , p_2 , p_3 of any point P in the plane whether it is within the triangle or outside the triangle ABC satisfy the relation

$$p_1 + p_2 + p_3 = k \quad (2.1)$$

Thus trilinear coordinates of points A , B and C are $(0, 0, k)$, $(k, 0, 0)$ and $(0, k, 0)$ respectively. Trilinear coordinates of the centroid of triangle are $(k/3, k/3, k/3)$.

3. Now the plane $x + y + z = a$ is a set T of all points p whose trilinear coordinates p_1, p_2, p_3 satisfy the relation $p_1 + p_2 + p_3 = k$.

Let $p = (p_1, p_2, p_3)$ and $q = (q_1, q_2, q_3)$ be in T .

$$\text{By usual addition } p + q = (p_1 + q_1, p_2 + q_2, p_3 + q_3) \notin T, \quad (3.1)$$

$$\text{since } (p_1 + q_1) + (p_2 + q_2) + (p_3 + q_3) = (p_1 + p_2 + p_3) + (q_1 + q_2 + q_3) = 2k \quad (3.2)$$

$$\text{By usual scalar multiplication by } \alpha, \alpha p = (\alpha p_1, \alpha p_2, \alpha p_3) \notin T, \quad (3.3)$$

$$\text{since } \alpha p_1 + \alpha p_2 + \alpha p_3 = \alpha (p_1 + p_2 + p_3) = \alpha k. \quad (3.4)$$

In view of (3.1), (3.2), (3.3) and (3.4) the set T is not closed with respect to the usual vector addition and scalar multiplication. Hence it can not become a linear space.

4. Now we shall prove, by defining following new algebraic operations, T is a linear space in which components of additive identity are nonzero.

4.1 **Definition** Let $p = (p_1, p_2, p_3)$ & $q = (q_1, q_2, q_3)$ be in T .

We define :

a. **Equality :**

$$p = q \text{ if and only if } p_1 = q_1, p_2 = q_2, p_3 = q_3.$$

b. **Sum :**

$$p + q = (-k/3 + p_1 + q_1, -k/3 + p_2 + q_2, -k/3 + p_3 + q_3)$$

c. **Multiplication by real numbers :**

$$\alpha p = ((1 - \alpha)k/3 + \alpha p_1, (1 - \alpha)k/3 + \alpha p_2, (1 - \alpha)k/3 + \alpha p_3) \\ (\alpha \text{ real})$$

d. **Difference :**

$$p - q = p + (-1)q.$$

e. **Zero vector (centroid of the triangle):**

$$0 = (k/3, k/3, k/3).$$

- 5.1 To every pair of elements p and q in T there corresponds an element $p + q$, in such a way that

$$p + q = q + p \quad \text{and} \quad p + (q + r) = (p + q) + r.$$

$$p + 0 = p \quad \text{for every } p \in T.$$

To each $p \in T$ there exists a unique element $-p$ such that $p + (-p) = 0$

T is an abelian group with respect to vector addition.

- 5.2 For every $\alpha, \beta \in \mathbb{R}$ and $p, q \in T$ we have

$$\text{i) } \alpha (\beta p) = (\alpha \beta) p$$

$$\text{ii) } \alpha (p + q) = \alpha p + \alpha q,$$

$$\text{iii) } (\alpha + \beta) p = \alpha p + \beta p$$

$$\text{iv) } 1p = p.$$

Therefore T is a real linear space.

- Remark .1. The real number k is related with the position of the plane $x+y+z= a$ in R^3
2. There are infinite number of linear spaces of above kind in R^3

References.

1. Loney S.L. (1952): The Elements of coordinate Geometry Part II , Macmillan and Co. Ltd.
2. Smith Charles (1948): An Elementary Treatise on conic sections" Macmillan and Co. Ltd.
3. Sen B. (1968): Trilinear Coordinates and Boundry Value Problems, Bull. Cal. Math. Soc., 60(1-2), pp. 25-30.

G.L. Waghmare ,
Lecturer in Mathematics,
Govt. Arts & Science College ,
Aurangabad.-431 001 (M.S.)
India.

S.V. More,
Prof. & Head, Department of Mathematics,
Institute of Science, R.T.Road, Nagpur-1
(M.S.) India.

Lattices of Smarandache Groupoid

Dwiraj Talukdar
Head
Department of Mathematics
Nalbari College, Nalbari
Assam, India

Abstract :

Smarandache groupoid (Z_p, Δ) is not partly ordered under Smarandache inclusion relation but it contains some partly ordered sets, which are lattices under Smarandache union and intersection. We propose to establish the complemented and distributive lattices of Smarandache groupoid. Some properties of these lattices are discussed here.

1. Preliminaries :

The following definitions and properties are recalled to introduce complemented and distributive lattices of Smarandache groupoid .

Definition 1.1

A set S is partly ordered with respect to a binary relation R if this relation on S is reflexive, antisymmetric and transitive.

Definition 1.2

Two partly ordered sets S_1 and S_2 are isomorphic if there exists a one - one correspondence T between S_1 and S_2 such that for $x \in S_1$ and $y \in S_1$,

$$T(x) \subseteq T(y) \text{ iff } x \subseteq y$$

Definition 1.3

A lattice is a partly ordered set in which any two elements x and y have a greatest lower bound or infimum denoted by $x \cap y$ and a least upper bound or supremum denoted by $x \cup y$.

Definition 1.4

If every element of lattice has a complement , then it is called complemented lattice.

Definition 1.5

A lattice L is called distributive if identically

$$x \cap (y \cup z) = (x \cap y) \cup (x \cap z), \forall x, y, z \in L.$$

Definition 1.6

If a lattice L is distributive and complemented then it is called a Boolean lattice.

2. Lattices of Smarandache groupoid :

We introduce some definitions to establish the lattices of Smarandache groupoid.

Definition 2.1

- i) Two integer $r = (a_{n-1} a_{n-2} \dots a_1 a_0)_m$ and $s = (b_{n-1} b_{n-2} \dots b_1 b_0)_m$ are said to be equal and written as $r = s$ if $a_i = b_i$ for $i = 0, 1, 2, \dots, n - 1$.
- ii) The integer: $r = (a_{n-1} a_{n-2} \dots a_1 a_0)_m$ is contained in the integer $s = (b_{n-1} b_{n-2} \dots b_1 b_0)_m$ and written as $r \subseteq s$ if $a_i \leq b_i$ for $i = 0, 1, \dots, n - 1$. This relation is called Smarandache inclusion relation.
- iii) The Smarandache union of two integers r and s is denoted by $r \cup s$ and defined as

$$\begin{aligned} r \cup s &= (a_{n-1} a_{n-2} \dots a_1 a_0) \cup (b_{n-1} b_{n-2} \dots b_1 b_0) \\ &= (c_{n-1} c_{n-2} \dots c_1 c_0) \end{aligned}$$

$$\text{where } c_i = \max \{a_i, b_i\} \text{ for } i = 0, 1, \dots, n - 1.$$

- iv) The Smarandache intersection of two integers r and s is denoted by $r \cap s$ and defined as-

$$\begin{aligned} r \cap s &= (a_{n-1} a_{n-2} \dots a_1 a_0) \cap (b_{n-1} b_{n-2} \dots b_1 b_0) \\ &= (d_{n-1} d_{n-2} \dots d_1 d_0) \end{aligned}$$

$$\text{Where } d_i = \min \{a_i, b_i\} \text{ for } i = 0, 1, 2, \dots, n - 1.$$

- v) The complement of the integer $r = (a_{n-1} a_{n-2} \dots a_1 a_0)_m$ is redefined as -

$$C(r) = (e_{n-1} e_{n-2} \dots e_1 e_0)_m$$

$$\text{Where } e_i = 1 - a_i \text{ for } i = 0, 1, \dots, n - 1.$$

Proposition 2.2

The Smarandache groupoid (Z_p, Δ) with two operations Smarandache union and intersection satisfies the following properties for $x, y, z \in Z_p$.

- i) Idempotency : $x \cup x = x$ and $x \cap x = x$
- ii) Commutativity : $x \cup y = y \cup x$ and $x \cap y = y \cap x$
- iii) Associativity : $(x \cup y) \cup z = x \cup (y \cup z)$ and $(x \cap y) \cap z = x \cap (y \cap z)$.
- iv) Absorption : $x \cup (x \cap y) = x = x \cap (x \cup y)$ if $x \subseteq y$.

But (Z_p, Δ) is not partly ordered with respect to Smarandache inclusion relation and this groupoid consists of some partly ordered sets. Any two elements x and y of any partly ordered set of (Z_p, Δ) have infimum $x \cap y$ and supremum $x \cup y$. So these partly ordered sets are lattices of Smarandache groupoid (Z_p, Δ) . This can be verified with an example of Smarandache groupoid.

Example - 2. 3

The Smarandache groupoid (Z_{27}, Δ) is taken for verification.

Here $Z_{27} = \{0, 1, 2, \dots, 26\}$. For all $x, y \in Z_{27}$, x is not contained and equal to y under Smarandache inclusion relation. For example

$$11 = (1\ 0\ 2)_3 \quad \text{and} \quad 13 = (1\ 1\ 1)_3 \in Z_{27}$$

But $11 \not\subseteq 13$ under Smarandache inclusion relation. All the elements Z_{27} are not related. so reflexive, antisymmetric and transitive laws are not satisfied. Z_{27} is not treated as lattice under Smarandache inclusion relation.

Under this inclusion relation, some partly ordered sets are contained in Z_{27} . About 87 partly ordered sets of seven elements are determined in the Smarandache groupoid (Z_{27}, Δ) . A diagram of the above 87 partly ordered sets are given below :

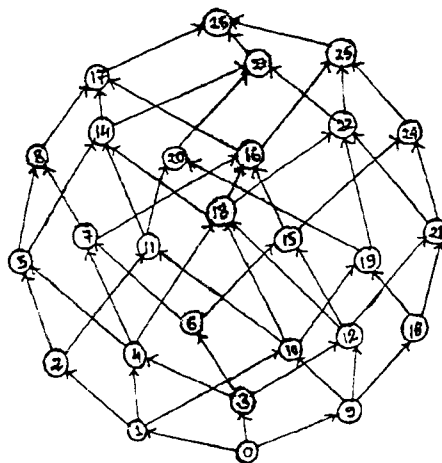

Consider a partly ordered set L , given by $0 \subseteq 1 \subseteq 2 \subseteq 5 \subseteq 8 \subseteq 17 \subseteq 26$ of Smarandache groupoid (Z_{27}, Δ) . The Smarandache intersection and union tables of this partly ordered set are given below :

\cap	0	1	2	5	8	17	26
0	0	0	0	0	0	0	0
1	0	1	1	1	1	1	1
2	0	1	2	2	2	2	2
5	0	1	2	5	5	5	5
8	0	1	2	5	8	8	8
17	0	1	2	5	8	17	17
26	0	1	2	5	8	17	26

Table -1

\cup	0	1	2	5	8	17	26
0	0	1	2	5	8	17	26
1	1	1	2	5	8	17	26
2	2	2	2	5	8	17	26
5	5	5	5	5	8	17	26
8	8	8	8	8	8	17	26
17	17	17	17	17	17	17	26
26	26	26	26	26	26	26	26

Table -2

The system $(L, \subseteq, \cap, \cup)$ in which any two elements a and b have an infimum $a \cap b$ and a supremum $a \cup b$ is a lattice. Similarly, taking the other 86 partly ordered sets, we can show that they are lattices of the Smarandache groupoid (Z_{27}, Δ) . If we take the complement of every element of the lattice L , we get the following function.

$L =$	0	1	2	5	8	17	26
$C(L) =$	26	25	24	21	18	9	0

Here $L \neq C(L)$. But the system $(C(L), \subseteq, \cap, \cup)$ is a lattice. If $L = C(L)$, then the lattice $(L, \subseteq, \cap, \cup)$ is called complemented. The complemented lattices of seven elements belonging to (Z_{27}, Δ) are given below :

- $0 \subseteq 1 \subseteq 4 \subseteq 13 \subseteq 22 \subseteq 25 \subseteq 26$
- $0 \subseteq 1 \subseteq 10 \subseteq 13 \subseteq 16 \subseteq 25 \subseteq 26$
- $0 \subseteq 3 \subseteq 4 \subseteq 13 \subseteq 22 \subseteq 23 \subseteq 26$
- $0 \subseteq 3 \subseteq 12 \subseteq 13 \subseteq 14 \subseteq 23 \subseteq 26$
- $0 \subseteq 9 \subseteq 10 \subseteq 13 \subseteq 16 \subseteq 17 \subseteq 26$
- $0 \subseteq 9 \subseteq 12 \subseteq 13 \subseteq 14 \subseteq 17 \subseteq 26$

From table 1 and table 2, it is clear that $a \cup (b \cap c) = (a \cup b) \cap (a \cup c)$ and $a \cap (b \cup c) = (a \cap b) \cup (a \cap c) \forall a, b, c, \in L$.

Hence the lattice $(L, \subseteq, \cap, \cup)$ is a distributive lattice. Similarly we can show that the other lattices of (Z_{27}, Δ) are distributive. The above six complemented lattices are distributive and they are called Boolean lattices.

- Remark -**
- i) The ordinary intersection of two lattices is a lattice .
 - ii) The ordinary union of two lattices is not a lattice .

Proposition 2.4

Every Smarandache groupoid has a lattice.

Proof :

Let (Z_p, Δ) be a Smarandache groupoid. A partly ordered set L_1 of Z_p is determined with respect to the Smarandache inclusion relation.

$$\text{Let } L_1 = \{0 = I_{10} \subseteq I_{11} \subseteq I_{12} \subseteq \dots \subseteq I_{1p} = m^n - 1\}$$

For $I_{1i}, I_{1j} \in L_1$ we get

$$I_{1i} \subseteq I_{1j} \text{ or } I_{1i} \supseteq I_{1j}$$

case I : If $I_{1i} \subseteq I_{1j}$, then

$$I_{1i} \cap I_{1j} = I_{1i} \in L_1 \text{ and } I_{1i} \cup I_{1j} = I_{1j} \in L_1$$

Hence L_1 is a lattice of Z_p .

Case II : If $I_{1i} \supseteq I_{1j}$, then

$$I_{1i} \cap I_{1j} = I_{1j} \in L_1 \text{ and } I_{1i} \cup I_{1j} = I_{1i} \in L_1$$

Hence L_1 is a lattice of Z_p .

Proposition 2.5

Every distributive lattice is modular.

Proof : A modular lattice is defined as a lattice in which

$$z \subseteq x \text{ implies } x \cup (y \cap z) = (x \cup y) \cap z$$

Let $(L_1, \subseteq, \cap, \cup)$ be a distributive lattice, in which $I_{1i} \subseteq I_{1k}$,

$$\begin{aligned} \text{then } I_{1i} \cup (I_{1j} \cap I_{1k}) &= (I_{1i} \cup I_{1j}) \cap (I_{1i} \cup I_{1k}) \\ &= (I_{1i} \cup I_{1j}) \cap I_{1k} \end{aligned}$$

Hence $(L_1, \subseteq, \cap, \cup)$ is modular.

3. Isomorphic lattices :

Let L_1 and L_2 be two lattices of a Smarandache groupoid (Z_p, Δ) . A one - one mapping T from L_1 onto L_2 is said to be isomorphism if -

$$T(x \cup y) = T(x) \cup T(y) \text{ and}$$

$$T(x \cap y) = T(x) \cap T(y) \text{ for } x, y \in L_1.$$

Proposition . 3. 1

Two lattices having same number of elements of a smarandache groupoid (Z_p, Δ) are isomorphic to each other.

Proof : Let $L_1 = \{ l_{10} \subseteq l_{11} \subseteq l_{12} \subseteq \dots \subseteq l_{1p} \}$
 and $L_2 = \{ l_{20} \subseteq l_{21} \subseteq l_{22} \subseteq \dots \subseteq l_{2p} \}$

where $l_{10} = l_{20} = 0$ and $l_{1p} = l_{2p} = m^n - 1$ be two lattices of (Z_p, Δ) .

A one - one onto mapping $T : L_1 \rightarrow L_2$ is defined such that $T(l_{1i}) = l_{2i}$
 for all $l_{1i} \in L_1$

For $l_{1i} \subseteq l_{1j} \in L_1$,
 $l_{1i} \cup l_{1j} = l_{1j}$ and $l_{1i} \cap l_{1j} = l_{1i}$.

For $l_{2i} \subseteq l_{2j} \in L_2$,
 $l_{2i} \cup l_{2j} = l_{2j}$ and $l_{2i} \cap l_{2j} = l_{2i}$.

Again $T(l_{1i}) = l_{2i}$ and $T(l_{1j}) = l_{2j}$

Now $T(l_{1i}) \cup T(l_{1j}) = l_{2i} \cup l_{2j} = l_{2j}$ and

$T(l_{1i}) \cap T(l_{1j}) = l_{2i} \cap l_{2j} = l_{2i}$.

Here $T(l_{1i} \cup l_{1j}) = T(l_{1j}) = l_{2j} = T(l_{1i}) \cup T(l_{1j})$ and

$T(l_{1i} \cap l_{1j}) = T(l_{1i}) = l_{2i} = T(l_{1i}) \cap T(l_{1j})$

Hence the lattices L_1 and L_2 are isomorphic to each other.

Proposition 3.2

Let L and $C(L)$ be two lattices of Smarandache groupoid (Z_p, Δ) . If T be the mapping from L to $C(L)$, defined by $T(x) = C(x) \quad \forall \quad x \in L$, then

$$T(x \cup y) = T(x) \cap T(y) \text{ and}$$

$$T(x \cap y) = T(x) \cup T(y) \quad \forall \quad x, y \in L.$$

Proof : For $x \subseteq y \in L$, $x \cup y = y$ and $x \cap y = x$

Again $C(y) \subseteq C(x) \in C(L)$, $C(x) \cup C(y) = C(x)$ and $C(x) \cap C(y) = C(y)$

Here $T(x) = C(x)$ and $T(y) = C(y)$

Now $T(x) \cup T(y) = C(x) \cup C(y) = C(x)$ and

$T(x) \cap T(y) = C(x) \cap C(y) = C(y)$.

Again $T(x \cup y) = T(y) = C(y) = T(x) \cap T(y)$ and

$T(x \cap y) = T(x) = C(x) = T(x) \cup T(y)$

Proposition - 3. 3

Let L be a complemented lattice of (Zp, Δ) . If the mapping T from L to L , defined by

$T(x) = C(x) \quad \forall \quad x \in L$, then

$T(x \cup y) = T(x) \cap T(y)$ and

$T(x \cap y) = T(x) \cup T(y) \quad \forall \quad x, y \in L$.

Proof is similar to proposition 3.2

Acknowledgement :

I wish to express my gratitude to the secretary, Nalbari Branch , Assam Academy of Mathematics and the president, Nalbari College Teacher's unit for their encouragement in preparing this paper.

References :

- 1) Lambek, Joachim - Lectures on Rings and Modules.
Blaisdell Publishing Company, 1966
- 2) Hall, M - The theory of groups.
Macmillon Co. 1959 .
- 3) Talukdar, D - D - From of Smarandache groupoid.
Smarandache Notions Journal, Vol. - 11
No.- 1-2-3 Spring, 2000 (5 - 15)
- 4) Talukdar, D - The notions of the Smarandache group and the Smarandache Boolean ring.
Smarandache Notions Journal Vol. - 11,

SMARANDACHE HYPOTHESIS: EVIDENCES, IMPLICATIONS AND APPLICATIONS

Leonardo F. D. da Motta
lmotta@amazon.com.br

*Conselheiro Furtado, 1574/501
Belém, PA 66040-100, Brazil*

ABSTRACT: In 1972 Smarandache proposed that there is not a limit speed on the nature, based on the EPR-Bell (Einstein, Podolsky, Rosen, Bell) paradox. Although it appears that this paradox was solved recently, there are many other evidences that guide us to believe that Smarandache Hypothesis is right on quantum mechanics and even on the new unification theories. If Smarandache Hypothesis turns to be right under any circumstance, some concepts of modern physics would have to be "refit" to agree with Smarandache Hypothesis. Moreover, when the meaning of Smarandache Hypothesis become completely understood, a revolution on technology, specially in communication, will arise.

I. SUPERLUMINAL PHENOMENA EVIDENCES AND SMARANDACHE HYPOTHESIS

It appears that was Sommerfeld who first noticed the possible existence of faster-than-light particles, later on called tachyons by Feinberg [1]. However, tachyons have imaginary mass, so they had never been detected experimentally. By imaginary mass we understood as a mass prohibited by relativity. However, relativity does not directly forbid the existence of *mass less* superluminal particles, such as the photon, but suggests that superluminal phenomena would result in time travel. Hence, many physicists assumed that superluminal phenomena does not exist in the universe, otherwise we would have to explain all those "kill your grandfather" paradoxes [2]. A famous example of this sort of paradox is the causality problem.

Nevertheless, quantum mechanics suggest that superluminal communication exist. In fact, there are hypothesis on the obligatory existence of superluminal phenomena on nature [3, 4]. The EPR-Bell paradox is the most famous example. Pondering about this

paradox, Smarandache also said in 1993, in a lecture on Brazil, that there is no such thing as a limit speed on the universe, as postulated by Einstein [5]. It appears that recently this paradox was completely solved by L. E. Szabó [6]. Even so, there are still many more evidences of the infinite speed — or simply instantaneous communication — in the universe, as we shall see briefly.

I.1. The Rodrigues-Maiorino Theory

Studying solutions of Maxwell and Dirac-Weyl equations, Waldyr Rodrigues Jr. and José Maiorino were able to propose a full-unified theory for constructions of arbitrary speeds in nature (for arbitrary they meant $0 \leq v < \infty$) in 1996 [7]. They also proposed that there is no such thing as a limit speed in the universe, so that Smarandache Hypothesis can be promoted to theory, as Smarandache-Rodrigues-Maiorino (SRM) theory.

What is unique about Rodrigues-Maiorino theory is that special relativity principle suffers a breakdown, however, even relativistic constructions of quantum mechanics, such as Dirac equation, agree completely with superluminal phenomena. Also, according to Rodrigues-Maiorino theory, even well positioned mirrors can accelerate an electromagnetic wave to velocities greater of the light. This assumption was later on confirmed by Saari and Reivelt (1997) [8], who produced a X-wave (named this way by Lu, J. Y., a Rodrigues' contributor) using a xenon lamp intercepted with a set of lens and orifices.

The SRM theory is a mathematical pure and strong solution of the relativistic quantum wave equation, indicating that there is no speed limit in the universe, and therefore is the most powerful theory today for construction of arbitrary speeds.

I.2. Superluminal Experiments

Many experiments, mainly evanescent modes, result in superluminal propagation. The first successful evanescent mode result was obtained in 1992 by Nimtz [9]. Nimtz produced a $4.34c$ signal. Later on he would produce a $4.7c$ FM signal with Mozart's 40th symphony. This achievement of Nimtz would be passed over by other results even eight times faster than the constant c .

In the case of Nimtz experiment is not clear if it violates the casual paradox. On the other hand, L. J. Wang, A. Kuzmich and A. Dogariu recently published an outstanding result of an anomalous dispersion experiment where a light pulse was accelerated to 310 ± 5 times the speed of light, not violating the casual paradox, thus resulting in a time travel! In practice, this means that a light pulse propagating through the atomic vapour cell appears at the exit side so much earlier than if it had propagated the same distance in a vacuum that the peak of the pulse appears to leave the cell before entering it [10].

I.3. The Speed of Gravity Revisited

The general relativity of Einstein postulates that the speed of gravity force is the same as the constant c due to the restriction of the special theory of relativity. However, if the speed of light is not a limit on the universe, isn't time to revisit this postulate? Van Flandern published some astrophysical results that indicate gravity is superluminal [11]. Observations of some galaxies rotations made by NASA suggest that some galaxies are spinning with superluminal velocity [12].

Van Flandern data was later on explained with a theory that does not need superluminal phenomena by Ivison, Puthoff and S. R. Little [13]. Yet, observations of superluminal signaling from galaxies remains unexplained from subluminal point of view.

I.4. Tachyons

Some models to the superstring theory, our foremost candidate for the unified theory of physics, include tachyons, the particles able to move faster than light. Even so, physicists found a way of hacking the theory so that tachyons disappear; some others, like Freedman, defend that the theory should not be hacked that way at all [1]. The superstring theory is probably the best field for studying tachyons, for it will not make you work with imaginary masses. Prof. Michio Kaku compared the idea of more dimensions in physics to a matrix scheme in his book *Hyperspace*. Imagine a matrix of 4×4 , that inside we can have the Theory of Relativity, and another were we have the quantum mechanics. If we build a bigger matrix, say 8×8 , we can therefore include both relativity and quantum mechanics in a single matrix. That is the main idea of unification through the addition of more dimensions. In the same way, working only with the 4×4 matrixes, we do not have enough space for working with tachyons. However, in a bigger matrix we will have enough space for finding solid solutions of tachyonic models.

Tachyons were already, in an obscure manner, detected in air showers from cosmic rays [2].

II. IMPLICATIONS AND APPLICATIONS

According to Rodrigues-Maiorino theory, the consequence of the existence of superluminal phenomena would be the breakdown of the special relativity principle. But we will not need to modify anything in quantum mechanics itself. More precisely, it appears that is quantum mechanics, which is banning the old pure relativity, according to SRM theory. Nevertheless, the theory of relativity indeed accepts some sort of superluminal communication, resulting in time travel, as Wang et al showed it.

Perhaps we would be able, in a distant future, to send messages to the past or to the future. Anyway, superluminal phenomena would have a more stand-on-ground

application with local communication. According to Rodrigues-Maiorino theory, the X-wave is *closed* in a way that it does not loss energy as it travels. So, a superluminal X-wave radio message would achieve its destination almost in the same condition as when it were sent and no one, except the destination, could spy the content of the message. The invention of such superluminal-signaling transmitter would be of great power associated with MIT's pastille able to curve light in 90° , in the manufacturing of optic fibers.

III. CONCLUSION

The various experiments and solid theories that rise from quantum mechanics involving superluminal phenomena are a high-level indication of the Smarandache Hypothesis, that there is no such speed limit in nature. This implies in a breakdown of Einstein postulate of relativity, but not in any field of quantum mechanics, even on the relativistic wave equation. As in our evolution came a time that newtonian dynamics were not enough to understand some aspects of nature, it is maybe getting a time when Einstein's relativity must be left aside, for hence quantum mechanics will rule.

ACKNOWLEDGEMENTS: Dr. Minh Perez at the American Research Press for the invitation, discussions, material, etc.

REFERENCES

- [1] Freedman, David. *Beyond Einstein*. Discovery. **10** (Feb. 1995): 56-61.
- [2] Herbert, Nick. *Faster than Light: Superluminal Loopholes in Physics*. Plume Books, New York, USA (1989)
- [3] Shan, Gao. *Quantum superluminal communication must exist*. (Jun. 1999) physics/9907005; IQMC-99-06-GSE-1
- [4] Shan, Gao. *Quantum superluminal communication does not result in casual loop paradoxes*. (Jun. 1999) quant-ph/9906113; IQM-99-5
- [5] Smarandache, Florentin, *There Is No Speed Barrier In The Universe*. Bulletin of Pure and Applied Sciences, Delhi, India, Vol. **17D** (Physics), No. 1, p. 61 (1998). Also at: <http://www.gallup.unm.edu/~smarandache/NoSpLim.htm>

- [6] Szabó, L. E. *Complete Resolution of the EPR-Bell Paradox*. Eötvös, Budapest (Jun.1998), quant-ph/9806074, Eötvös HPS 98-6
- [7] Rodrigues, Waldyr A. & Maiorino, José E. *A unified theory for construction of arbitrary speeds solutions of the relativistic wave equations*. Random Oper. and Stoch. Equ., Vol 4, No. 4, p. 355-400 (1996).
- [8] Saari, P. & Reivelt, K. *Evidence of X-Shaped Propagation-Invariant Localized Light Waves*. Phys. Rev. Lett. 21, 4135- (1997).
- [9] Nimtz, G. *Superluminal Signal Velocity*. Ann. der Physik 7, 1999, p. 618-624.
- [10] Wang, L. J. & Kuzmich, A. & Dogariu, A. *Gain-assisted Superluminal Propagation*. Nature, 406, p. 277-279 (July, 2000).
- [11] Flandern, T. Van. *The speed of gravity – what the experiments say*. Phys. Lett. A, 250 (1998), 1.
- [12] Harmon, B. A. *Galatic Superluminal Source*. In: 3rd INTEGRAL Workshop: the Extreme Universe, Taormina, Italy, 14 - 18 Sep 1998 / Ed. by G Palumbo, A Bazzano and C Winkler - Astrophys. Lett. Commun. astro-ph/9812397
- [13] Ivison, Michael & Puthoff, Harold E. & Little, Scott R. *The speed of gravity revisited*. Phys. Lett., A (Nov. 1999) physics/9910050
- [14] Smarandache, Florentin, *Life at Infinite Speed*, 1972, Arizona State University, Special Collections, Hayden Library, Tempe.

Smarandache-Rodrigues-Maiorino (SRM) Theory

by

Leonardo F. D. da Motta

lmotta@amazon.com.br

Conselheiro Furtado, 1574/501

Belém, PA 66040-100, Brazil

Studying solutions of Maxwell and Dirac-Weyl equations, Waldyr Rodrigues Jr. and José Maiorino were able to propose a full-unified theory for constructing of arbitrary speeds in nature (for arbitrary they meant $0 \leq v < \text{infinity}$) in 1996 [3]. So that Smarandache Hypothesis proposed in 1972 [6, 2], that there is no speed barrier in the universe, can be promoted to theory, as Smarandache-Rodrigues-Maiorino (SRM) theory [2, 1].

What is unique about Rodrigues-Maiorino theory is that special relativity principle suffers a breakdown, however, even relativistic constructions of quantum mechanics, such as Dirac equation, agree completely with superluminal phenomena. Also, according to Rodrigues-Maiorino theory, even well positioned mirrors can accelerate an electromagnetic wave to velocities greater of the light. This assumption was later on confirmed by Saari and Reivelt in 1997 [4], who produced a X-wave (named this way by J. Y. Lu, a Rodrigues' contributor [5]) using a xenon lamp intercepted with a set of lens and orifices.

The SRM theory is a mathematical pure and strong solution of the relativistic quantum wave equation, indicating that there is no speed limit in the universe, and therefore is the most powerful theory today for construction of arbitrary speeds.

References:

[1] Le, Charles T., Book Review of “*Definitions, Solved and Unsolved Problems, Conjectures, and Theorems in Number Theory and Geometry*” by Florentin Smarandache (*Xiquan Publ. Hse., Phoenix, 83 p., 2000*), in “*Zentralblatt für Mathematik*”, Berlin, 991.48383, 2000.

[2] Motta, Leonardo F. D. da, “*Smarandache Hypothesis: Evidences, Implications, Applications*”, *Quantum Physics journal*,

http://www.geocities.com/m_l_perez/QuantumPhysics.html,

<http://www.gallup.unm.edu/~smarandache/Sm-Hvp.htm>.

[3] Rodrigues, Waldyr A. & Maiorino, José E. *A unified theory for construction of arbitrary speeds solutions of the relativistic wave equations*. Random Oper. and Stoch. Equ., Vol. 4, No. 4, p. 355-400 (1996).

[4] Saari, P. & Reivelt, K. *Evidence of X-Shaped Propagation-Invariant Localized Light Waves*. Phys. Rev. Lett. 21, 4135, (1997).

[5] Rodrigues, Waldyr A. & Lu, J. Y. *On the Existence of Undistorted Progressive Waves of Arbitrary Speeds In Nature*. Found. Phys. 27, 435-508 (1997).

[6] Smarandache, F. *There Is No Speed Barrier in the Universe*. Bull. Pure Appl. Sci., 17D, 61, 1998;
<http://www.gallup.unm.edu/~smarandache/NoSpLim.htm>.

QUANTUM SMARANDACHE PARADOXES

edited by Gheorghe Niculescu
Str. Muncii, Bl. B₁, Ap. 50
2698 Uricani, Hunedoara, Romania

Abstract. In this paper one presents four of the smarandacheian paradoxes in physics found in various physics sites or printed material.

- 1) **Sorites Paradox** (associated with Eubulides of Miletus (fourth century B.C.):
Our visible world is composed of a totality of invisible particles.
 - a) An invisible particle does not form a visible object, nor do two invisible particles, three invisible particles, etc.
However, at some point, the collection of invisible particles becomes large enough to form a visible object, but there is apparently no definite point where this occurs.
 - b) A similar paradox is developed in an opposite direction. It is always possible to remove a particle from an object in such a way that what is left is still a visible object. However, repeating and repeating this process, at some point, the visible object is decomposed so that the left part becomes invisible, but there is no definite point where this occurs.
Generally, between $\langle A \rangle$ and $\langle \text{Non-}A \rangle$ there is no clear distinction, no exact frontier. Where does $\langle A \rangle$ really end and $\langle \text{Non-}A \rangle$ begin? One extends Zadeh's "fuzzy set" term to the "neutrosophic set" concept.
- 2) **Uncertainty Paradox:** Large matter, which is under the 'determinist principle', is formed by a totality of elementary particles, which are under Heisenberg's 'indeterminacy principle'.
- 3) **Unstable Paradox:** Stable matter is formed by unstable elementary particles.
- 4) **Short Time Living Paradox:** Long time living matter is formed by very short time living elementary particles.

References:

- [1] Marie-Helene Boyer, "Re: How are possible the Smarandache Uncertainty, Unstable, etc. Paradoxes?", MAD Scientist, Washington University School of Medicine, St. Louis, Missouri, <http://www.madsci.org/posts/archives/972501333.Ph.r.html>.
- [2] Chong Hu, "How are possible the Smarandache Uncertainty, Unstable, etc. Paradoxes?", MAD Scientist, Washington University School of Medicine, St. Louis, Missouri, <http://www.madsci.org/posts/archives/972501333.Ph.q.html>.

[3] Chong Hu, "How do you explain the Smarandache Sorites Paradox?", MAD Scientist, Washington University School of Medicine, St. Louis, Missouri, <http://www.madsci.org/posts/archives/970594003.Ph.q.html>.

[4] Amber Iler, "Re: How do you explain the Smarandache Sorites Paradox?", MAD Scientist, Washington University School of Medicine, St. Louis, Missouri, <http://www.madsci.org/posts/archives/970594003.Ph.r.html>.

[5] Florentin Smarandache, "Invisible Paradox" in "Neutrosophy. / Neutrosophic Probability, Set, and Logic", American Research Press, Rehoboth, 22-23, 1998.

[6] Florentin Smarandache, "Sorites Paradoxes", in "Definitions, Solved and Unsolved Problems, Conjectures, and Theorems in Number Theory and Geometry", Xiquan Publishing House, Phoenix, 69-70, 2000.

[7] Louisiana Smith and Rachael Clanton, advisor Keith G. Calkins, "Paradoxes" project, Andrews University, <http://www.andrews.edu/~calkins/math/biograph/topparad.htm>.

C O N T E N T S

MATHEMATICS:

<i>ROBERTO TORRETTI, A Model for Smarandache's Anti-Geometry</i>	5
<i>FLORIAN LUCA, The Average Smarandache Function</i>	19
<i>TATIANA TABIRCA, SABIN TABIRCA, A Parallel Loop Scheduling Algorithm Based on the Smarandache f-Inferior Part Function</i> ..	28
<i>HENRY IBSTEDT, On the Pseudo-Smarandache Function and Iteration Problems. Part I: The Euler ϕ Function</i>	36
<i>HENRY IBSTEDT, On the Pseudo-Smarandache Function and Iteration Problems. Part II: The Sum of Divisors Function</i>	44
<i>SABIN TABIRCA, Erdős-Smarandache Moments Numbers</i>	49
<i>SABIN TABIRCA, TATIANA TABIRCA, Erdős-Smarandache Numbers</i>	54
<i>J. SÁNDOR, On the Pseudo-Smarandache Function</i>	59
<i>HENRY IBSTEDT, Smarandache k-k Additive Relationships</i>	62
<i>KRASSIMIR T. ATANASSOV, Remarks on Some of the Smarandache's Problems. Part 1</i>	82
<i>HENRY IBSTEDT, A Brief Account on Smarandache 2-2 Subtractive Relationships</i>	99
<i>HENRY IBSTEDT, On a Smarandache Partial Perfect Additive Sequence</i>	103
<i>NIKOLAI NIKOLOV, KRASSIMIR ATANASSOV, On the 107-th, 108-th and 109-th Smarandache's Problems</i>	108
<i>KRASSIMIR T. ATANASSOV, On the 20-th and the 21-st Smarandache's Problems</i>	111
<i>SABIN TABIRCA, TATIANA TABIRCA, On the Primality of the Smarandache Symmetric Sequences</i>	114
<i>KRASSIMIR T. ATANASSOV, On Four Prime and Coprime Functions</i> .	122
<i>Y. V. CHEBRAKOV, V. V. SHMAGIN, Investigating Connections Between Some Smarandache Sequences, Prime Numbers and Magic Squares</i> .	126
<i>TIANG ZHENGPING, XU KANGHUA, On Smarandache Sequences and Subsequences</i>	146
<i>FELICE RUSSO, On Three Problems Concerning the Smarandache LCM Sequence</i>	153
<i>FELICE RUSSO, On a Problem Concerning the Smarandache Unary Sequence</i>	156
<i>FELICE RUSSO, An Introduction to the Smarandache Double Factorial Function</i>	158
<i>ADRIAN VASIU, ANGELA VASIU, Geometrie Interioară</i>	168
<i>FELICE RUSSO, On Some Smarandache Conjectures and Unsolved</i>	

Problems	172
FELICE RUSSO, A Recurrence Formula for Prime Numbers Using the Smarandache or Totient Functions	193
FELICE RUSSO, On Two Problems Concerning Two Smarandache P-Partial Digital Sequences	198
MIHALY BENCZE, Open Questions for the Smarandache Function ..	201
MAOHUA LE, On Smarandache Algebraic Structures. I: The Commutative Multiplicative Semigroup $A(a,n)$	204
MAOHUA LE, On Smarandache Algebraic Structures. II: The Smarandache Semigroup	207
MAOHUA LE, On Smarandache Algebraic Structures. III: The Commutative Ring $B(a,n)$	209
MAOHUA LE, On Smarandache Algebraic Structures. IV: The Commutative Ring $C(a,n)$	211
MAOHUA LE, On Smarandache Algebraic Structures. V: Two Classes of Smarandache Rings	213
MAOHUA LE, A Note on the Smarandache Bad Numbers	215
MAOHUA LE, A Lower bound for $S(2^{p-1}(2^p-1))$	217
MAOHUA LE, The Squares in the Smarandache Higher Power Product Sequences	21364
MAOHUA LE, The Powers in the Smarandache Square Product Sequences	221
MAOHUA LE, The Powers in the Smarandache Cubic Product Sequences	223
MAOHUA LE, On the Smarandache Uniform Sequences	226
MAOHUA LE, The Primes in the Smarandache Power Product Sequences of the Second Kind	228
MAOHUA LE, The Primes in the Smarandache Power Product Sequences of the First Kind	230
MAOHUA LE, On the Equation $S(mn)=m^k S(n)$	232
MAOHUA LE, On an Inequality Concerning the Smarandache Function	234
MAOHUA LE, The Squares in the Smarandache Factorial Product Sequence of the Second Kind	236
MAOHUA LE, On the Third Smarandache Conjecture about Primes .	238
MAOHUA LE, On Russo's Conjecture about Primes	240
MAOHUA LE, A Conjecture Concerning the Reciprocal Partition Theory	242
MAOHUA LE, A Sum Concerning Sequences	244
J. SÂNDOR, A Note on $S(n^2)$	246
J. SÂNDOR, On A New Smarandache Type Function	247
MIHALY BENCZE, About the $S(n)=S(n-S(n))$ Equation	249
SAM ALEXANDER, A Note on Smarandache Reverse Sequence	250

AMARNATH MURTHY, Smarandache Pascal Derived Sequences	251
AMARNATH MURTHY, Depascalisation of Smarandache Pascal Derived Sequences and Backward Extended Fibonacci Sequence	255
AMARNATH MURTHY, Proof of the Depascalisation Theorem	258
JÓZSEF SÁNDOR, On Certain Arithmetic Functions	260
AMARNATH MURTHY, Smarandache Star (Stirling) Derived Sequences	262
AMARNATH MURTHY, Smarandache Friendly Numbers and A Few More Sequences	264
AMARNATH MURTHY, Smarandache Geometrical Partitions and Sequences	268
AMARNATH MURTHY, Smarandache Route Sequences	272
AMARNATH MURTHY, Smarandache Determinant Sequences	275
AMARNATH MURTHY, Smarandache Reverse Auto Correlated Sequences and Some Fibonacci Derived Smarandache Sequences	279
AMARNATH MURTHY, Smarandache Strictly Stair Case Sequences .	283
CSABA BÍRÓ, About a New Smarandache-type Sequence	284
LEONARDO MOTTA, On the Smarandache Paradox	287
SEBASTIÁN MARTÍN RUIZ, New Prime Numbers	289
TAEKYUN KIM, A Note on the Value of Zeta	291
FELICE RUSSO, Ten Conjectures on Prime Numbers	295
ADRIAN VASIU, ANGELA VASIU, On Some Implications of Formalized Theories in our Life	297
AMARNATH MURTHY, Decomposition of the Divisors of A Natural Number Into Pairwise Co-Prime Sets	303
AMARNATH MURTHY, Some Notions on Least Common Multiples	307
AMARNATH MURTHY, Smarandache Dual Symmetric Functions and Corresponding Numbers of the Type of Stirling Numbers of the First Kind	309
AMARNATH MURTHY, Some More Conjectures on Primes and Divisors	311
MAOHUA LE, The Reduced Smarandache Square-Digital Subsequence is Infinite	313
MAOHUA LE, The Reduced Smarandache Cube-Partial-Digital Subsequence is Infinite	315
MAOHUA LE, The Convergence Value and the Simple Continued Fractions of Some Smarandache Sequences	317
MAOHUA LE, The First Digit and the Trailing Digit of Elements of the Smarandache Deconstructive Sequence	319
MAOHUA LE, The 2-Divisibility of Even Elements of the Smarandache Deconstructive Sequence	321
MAOHUA LE, Two Smarandache Series	323
MAOHUA LE, The 3-Divisibility of Elements of the Smarandache Deconstructive Sequence	325
MAOHUA LE, Two Conjectures Concerning Extents of Smarandache	

<i>Factor Partition</i>	328
<i>MAOHUA LE, On the Balu Numbers</i>	331
<i>MAOHUA LE, The Limit of the Smarandache Divisor Sequences</i> ..	335
<i>KRASSIMIR ATANASSOV, HRISTO ALADJOV, A Generalized Net For Machine Learning of the Process of Mathematical Problems Solving. / On An Example with A Smarandache Problem</i>	338
<i>G. L. Waghmare, S. V. More, New Smarandache Algebraic Structures</i>	344
<i>DWIRAJ TALUKDAR, Lattice of Smarandache Groupoid</i>	347

PHYSICS:

<i>LEONARDO F. D. DA MOTTA, Smarandache Hypothesis: Evidences, Implications and Applications</i>	354
<i>LEONARDO F. D. DA MOTTA, Smarandache-Rodrigues-Maiorino (SRM) Theory</i>	359
<i>GHEORGHE NICULESCU, Quantum Smarandache Paradoxes</i>	361

The "Smarandache Notions Journal" is online at:

<http://www.gallup.unm.edu/~smarandache/>

and selected papers are periodically added to our web site. The authors are pleased to send, together with their hard copy manuscripts, a floppy disk with HTML or ASCII files to be put in the Internet as well.

Papers in electronic form are accepted. They can be e-mailed in Microsoft Word 97 (or lower), WordPerfect 7.0 (or lower), PDF 4.0, or ASCII files.

Starting with this Vol. 10, the "Smarandache Notions Journal" is also printed in hard cover for a special price of \$79.95.

\$69.90