

Foundations of Neutrosophic Logic and Set and their Applications to Information Fusion

**Prof. Florentin Smarandache, Ph D
The University of New Mexico
Math & Science Dept.
705 Gurley Ave.
Gallup, NM 87301, USA**

fs.gallup.unm.edu/neutrosophy.htm

Content

THEORY

- **Definition of Neutrosophy**
- **A Short History of the Logics**
- **Introduction to Non-Standard Analysis**
- **Operations with Classical Sets**
- **Neutrosophic Logic (NL)**
- **Refined Neutrosophic Logic and Set**
- **Classical Mass and Neutrosophic Mass**
- **Differences between Neutrosophic Logic and Intuitionistic Fuzzy Logic**
- **Neutrosophic Logic generalizes many Logics**
- **Neutrosophic Logic Connectors**
- **Neutrosophic Set (NS)**
- **Neutrosophic Cube as Geometric Interpretation of the Neutrosophic Set**
- **Neutrosophic Set Operators**
- **Differences between Neutrosophic Set and Intuitionistic Fuzzy Set**
- **Partial Order in Neutrosophics**
- **N-Norm and N-conorm**

Content (2)

- **Interval Neutrosophic Operators**
- **Remarks on Neutrosophic Operators**
- **Examples of Neutrosophic Operators resulted from N-norms and N-conorms**

APPLICATIONS

- **Application of Fuzzy Logic to Information Fusion**
- **Application of Neutrosophic Logic to Information Fusion**
- **How to Compute with Labels**
- **General Applications of Neutrosophic Logic**
- **General Applications of Neutrosophic Sets**
- **Neutrosophic Numbers**
- **Neutrosophic Algebraic Structures**
- **Neutrosophic Matrix**
- **Neutrosophic Graphs and Trees**
- **Neutrosophic Cognitive Maps & Neutrosophic Relational Maps**
- **Neutrosophic Probability and Statistics**
- **Applications of Neutrosophy to Extenics and Indian Philosophy**

Content (3)

- **Neutrosophics as a situation analysis tool**
- **Application to Robotics**
- **The Need for a Novel Decision Paradigm in Management (F. S. & S. Bhattacharya)**
- **Application of Neutrosophics in Production Facility Layout Planning and Design (F. S. & S. Bhattacharya)**
- **Applications to Neutrosophic and Paradoxist Physics**
- **More Applications**

Definition of Neutrosophy

- **A new branch of philosophy** which studies the origin, nature, and scope of neutralities, as well as their interactions with different ideational spectra (1995).
 - Neutrosophy opened a new field or research in metaphilosophy.
 - **Etymologically**, *neutro-sophy* [French *neutre* < Latin *neuter*, neutral, and Greek *sophia*, skill/wisdom] means knowledge of neutral thought and started in 1995.
 - **Extension of dialectics.**
 - Connected with Extenics (Prof. Cai Wen, 1983), and Paradoxism (F. Smarandache, 1980)
 - **The Fundamental Theory:** Every idea <A> tends to be neutralized, diminished, balanced by <nonA> ideas (not only <antiA> as Hegel asserted)
 - as a state of equilibrium.
- <nonA> = what is not <A>, <antiA> = the opposite of <A>, and
<neutA> = what is neither <A> nor <antiA>
- In a classical way <A>, <neutA>, <antiA> are disjoint two by two.
But, since in many cases the borders between notions are vague, imprecise, Sorites, it is possible that <A>, <neutA>, <antiA> (and <nonA> of course) have common parts two by two as well.
- **Basement** for Neutrosophic Logic, Neutrosophic Set, Neutrosophic Probability, and Neutrosophic Statistics

A Short History of the Logics

The *fuzzy set* (FS) was introduced by L. Zadeh in 1965, where each element had a degree of membership.

The *intuitionistic fuzzy set* (IFS) on a universe X was introduced by K. Atanassov in 1983 as a generalization of FS, where besides the degree of membership $\mu_A(x) \in [0, 1]$ of each element x to a set A there was considered a degree of non-membership $\nu_A(x) \in [0, 1]$, but such that for $x \in X$, $\mu_A(x) + \nu_A(x) \leq 1$.

A Short History of the Logics (2)

According to Cornelis et al. (2003), Gehrke et al. (1996) stated that “Many people believe that assigning an exact number to an expert’s opinion is too restrictive, and the assignment of an interval of values is more realistic”, which is somehow similar with the imprecise probability theory where instead of a crisp probability one has an interval (upper and lower) probabilities as in Walley (1991).

Atanassov (1999) defined the *interval-valued intuitionistic fuzzy set* (IVIFS) on a universe X as an object A such that:

$$A = \{(x, M_A(x), N_A(x)), x \in X\},$$

with $M_A: X \rightarrow \text{Int}([0, 1])$ and $N_A: X \rightarrow \text{Int}([0, 1])$

and $x \in X, \sup M_A(x) + \sup N_A(x) \leq 1$.

A Short History of the Logics (3)

- Belnap (1977) defined a four-valued logic, with truth (T), false (F), unknown (U), and contradiction (C). He used a bi-lattice where the four components were inter-related.
- In 1995, starting from philosophy (when I fretted to distinguish between *absolute truth* and *relative truth* or between *absolute falsehood* and *relative falsehood* in logics, and respectively between *absolute membership* and *relative membership* or *absolute non-membership* and *relative non-membership* in set theory) I began to use the non-standard analysis.

A Short History of the Logics (4)

- Also, inspired from the sport games (winning, defeating, or tie scores), from votes (pro, contra, null/black votes), from positive/negative/zero numbers, from yes/no/NA, from decision making and control theory (making a decision, not making, or hesitating), from accepted/rejected/ pending, etc. and guided by the fact that the law of excluded middle did not work any longer in the modern logics, I combined the non-standard analysis with a tri-component logic/set/probability theory and with philosophy (I was excited by paradoxism in science and arts and letters, as well as by paraconsistency and incomplete-ness in knowledge). How to deal with all of them at once, is it possible to unity them?

A Short History of the Logics (5)

- I proposed the term "neutrosophic" because "neutrosophic" etymologically comes from "neutrosophy" [French *neutre* < Latin *neuter*, neutral, and Greek *sophia*, skill/wisdom] which means knowledge of neutral thought, and this third/neutral represents the main distinction between "fuzzy" and "intuitionistic fuzzy" logic/set, i.e. the *included middle* component (Lupasco-Nicolescu's logic in philosophy), i.e. the neutral/indeterminate/unknown part (besides the "truth"/"membership" and "falsehood"/"non-membership" components that both appear in fuzzy logic/set).

Introduction to Nonstandard Analysis

- Abraham Robinson developed the nonstandard analysis (1960s)
- x is called *infinitesimal* if $|x| < 1/n$ for any positive n
- A *left monad* $(^-a) = \{a-x: x \text{ in } \mathbb{R}^*, x > 0 \text{ infinitesimal}\} = a-\varepsilon$
and a *right monad* $(b^+) = \{a+x: x \text{ in } \mathbb{R}^*, x > 0 \text{ infinitesimal}\} = b+\varepsilon$
where $\varepsilon > 0$ is infinitesimal;
 a, b called *standard parts*, ε called *nonstandard part*.
- Operations with nonstandard finite real numbers:
 $^-a * b = ^-(a * b)$, $a * b^+ = (a * b)^+$, $^-a * b^+ = ^-(a * b)^+$,
 $^-a *^-b = ^-(a * b)$ [the left monads absorb themselves],
 $a^+ * b^+ = (a * b)^+$ [the right monads absorb themselves],
where “*” can be addition, subtraction, multiplication, division, power.

Operations with Classical Sets

S_1 and S_2 two real standard or nonstandard sets.

- Addition: $S_1 \oplus S_2 = \{x \mid x = s_1 + s_2, \text{ where } s_1 \in S_1 \text{ and } s_2 \in S_2\}$.
- Subtraction: $S_1 \ominus S_2 = \{x \mid x = s_1 - s_2, \text{ where } s_1 \in S_1 \text{ and } s_2 \in S_2\}$
- Multiplication: $S_1 \odot S_2 = \{x \mid x = s_1 \cdot s_2, \text{ where } s_1 \in S_1 \text{ and } s_2 \in S_2\}$
- Division of a set by a non-null number:

Let $k \in \mathbb{R}^*$, then $S_1 \oslash k = \{x \mid x = s_1/k, \text{ where } s_1 \in S_1\}$

Neutrosophic Logic

- Consider the *nonstandard unit interval* $]0, 1+[$, with left and right borders vague, imprecise
- Let T, I, F be standard or nonstandard subsets of $]0, 1+[$
- Neutrosophic Logic (NL) is a logic in which each proposition is T% true, I% indeterminate, and F% false
- $0 \leq \inf T + \inf I + \inf F \leq \sup T + \sup I + \sup F \leq 3$
- T, I, F are not necessary intervals, but any sets (discrete, continuous, open or closed or half-open/half-closed interval, intersections or unions of the previous sets, etc.)
- Example: proposition P is between 30-40% or 45-50% true, 20% indeterminate, and 60% or between 66-70% false (according to various analyzers or parameters)
- NL is a generalization of Zadeh's *fuzzy logic* (FL), and especially of Atanassov's *intuitionistic fuzzy logic* (IFL), and of other logics

Refined Neutrosophic Logic and Set

- Component "I", indeterminacy, can be split into more subcomponents in order to better catch the vague information we work with, and such, for example, one can get more accurate answers to the *Question-Answering Systems* initiated by Zadeh (2003).
- {In Belnap's four-valued logic (1977) indeterminacy was split into Uncertainty (U) and Contradiction (C), but they were inter-related.}
- Even more, we proposed to split "I" into Contradiction, Uncertainty, and Unknown, and we get a five-valued logic.
- In a general **Refined Neutrosophic Set**, "T" can be split into subcomponents T_1, T_2, \dots, T_m , and "I" into I_1, I_2, \dots, I_n , and "F" into F_1, F_2, \dots, F_p because there are more types of truths, of indeterminacies, and respectively of falsehoods.

Classical Mass & Neutrosophic Mass

Let Ω be a frame of discernment, defined as:

$$\Omega = \{\theta_1, \theta_2, \dots, \theta_n\}, n \geq 2,$$

and its Super-Power Set (or fusion space):

$$S^\Omega = (\Omega, U, \cap, \complement)$$

which means: the set Ω closed under union, intersection, and respectively complement.

Classical Mass.

We recall that a classical mass $m(\cdot)$ is defined as:

$$m: S^\Omega \rightarrow [0, 1]$$

such that

$$\sum m(X) = 1.$$

$$X \text{ in } S^\Omega$$

Classical Mass & Neutrosophic Mass (2)

We extend the classical basic belief assignment (or classical mass) $m(\cdot)$ to a neutrosophic basic belief assignment (nbba) (or neutrosophic mass) $m_n(\cdot)$ in the following way.

$$m_n: S^\Omega \rightarrow [0, 1]^3$$

with

$$m_n(A) = (T(A), I(A), F(A))$$

where $T(A)$ means the (local) chance that hypothesis A occurs, $F(A)$ means the (local) chance that hypothesis A does not occur (nonchance), while $I(A)$ means the (local) indeterminate chance of A (i.e. knowing neither if A occurs nor if A doesn't occur),

such that:

$$\sum [T(X) + I(X) + F(X)] = 1.$$

$$X \text{ in } S^\Omega$$

Classical Mass & Neutrosophic Mass (3)

In a more general way, the summation can be less than 1 (for incomplete neutrosophic information), equal to 1 (for complete neutrosophic information), or greater than 1 (for paraconsistent/conflicting neutrosophic information). But in this paper we only present the case when summation is equal to 1.

Of course

$$1 \leq T(X), I(X), F(X) \leq 1$$

for all X in S^Ω .

Differences between Neutrosophic Logic and Intuitionistic Fuzzy Logic

- In NL there is no restriction on T, I, F, while in IFL the sum of components (or their superior limits) = 1; thus NL can characterize the *incomplete information* (sum < 1), *paraconsistent information* (sum > 1).
- NL can distinguish, in philosophy, between *absolute truth* [NL(absolute truth)=1⁺] and *relative truth* [NL(relative truth)=1], while IFL cannot;
absolute truth is truth in all possible worlds (Leibniz),
relative truth is truth in at least one world.
- In NL the components can be nonstandard, in IFL they don't.
- NL, like *dialetheism* [some contradictions are true], can deal with paradoxes, NL(paradox) = (1,1,1), while IFL cannot.

Neutrosophic Logic generalizes many Logics

Let the components reduced to scalar numbers, t, i, f , with $t+i+f=n$;
NL generalizes:

- the *Boolean logic* (for $n = 1$ and $i = 0$, with t, f either 0 or 1);
- the *multi-valued logic*, which supports the existence of many values between true and false [Lukasiewicz, 3 values; Post, m values] (for $n = 1, i = 0, 0 \leq t, f \leq 1$);
- the *intuitionistic logic*, which supports incomplete theories, where $A \vee \bar{A}$ (Law of Excluded Middle) not always true, and “There exist x such that $P(x)$ is true” needs an algorithm constructing x [Brouwer, 1907]
(for $0 < n < 1$ and $i = 0, 0 \leq t, f < 1$);
- the *fuzzy logic*, which supports degrees of truth [Zadeh, 1965]
(for $n = 1$ and $i = 0, 0 \leq t, f \leq 1$);
- the *intuitionistic fuzzy logic*, which supports degrees of truth and degrees of falsity while what's left is considered indeterminacy [Atanassov, 1982] (for $n = 1$);

Neutrosophic Logic generalizes many Logics (cont'd)

- the *paraconsistent logic*, which supports conflicting information, and 'anything follows from contradictions' fails, i.e. $A \wedge \text{non}A \rightarrow B$ fails; $A \wedge \text{non}A$ is not always false (for $n > 1$ and $i = 0$, with both $0 < t, f < 1$);
- the *dialetheism*, which says that some contradictions are true, $A \wedge \text{non}A = \text{true}$ (for $t = f = 1$ and $i = 0$; some paradoxes can be denoted this way too);
- the *faillibilism*, which says that uncertainty belongs to every proposition (for $i > 0$);

Neutrosophic Logic Connectors

$A_1(T_1, I_1, F_1)$ and $A_2(T_2, I_2, F_2)$ are two propositions.

1. Negation:

$$NL(\neg A_1) = (\{1\} \ominus T_1, \{1\} \ominus I_1, \{1\} \ominus F_1).$$

2. Conjunction:

$$NL(A_1 \wedge A_2) = (T_1 \odot T_2, I_1 \odot I_2, F_1 \odot F_2).$$

(And, in a similar way, generalized for n propositions.)

3. Weak or inclusive disjunction:

$$NL(A_1 \vee A_2) = (T_1 \oplus T_2 \ominus T_1 \odot T_2, I_1 \oplus I_2 \ominus I_1 \odot I_2, F_1 \oplus F_2 \ominus F_1 \odot F_2).$$

(And, in a similar way, generalized for n propositions.)

4. Strong or exclusive disjunction:

$$NL(A_1 \vee\vee A_2) =$$
$$(T_1 \odot (\{1\} \ominus T_2) \oplus T_2 \odot (\{1\} \ominus T_1) \ominus T_1 \odot T_2 \odot (\{1\} \ominus T_1) \odot (\{1\} \ominus T_2),$$
$$I_1 \odot (\{1\} \ominus I_2) \oplus I_2 \odot (\{1\} \ominus I_1) \ominus I_1 \odot I_2 \odot (\{1\} \ominus I_1) \odot (\{1\} \ominus I_2),$$
$$F_1 \odot (\{1\} \ominus F_2) \oplus F_2 \odot (\{1\} \ominus F_1) \ominus F_1 \odot F_2 \odot (\{1\} \ominus F_1) \odot (\{1\} \ominus F_2)).$$

(And, in a similar way, generalized for n propositions.)

5. Material conditional (implication):

$$NL(A_1 \rightarrow A_2) = (\{1\} \ominus T_1 \oplus T_1 \odot T_2, \{1\} \ominus I_1 \oplus I_1 \odot I_2, \{1\} \ominus F_1 \oplus F_1 \odot F_2).$$

6. Material biconditional (equivalence):

$$NL(A_1 \leftrightarrow A_2) = ((\{1\} \ominus T_1 \oplus T_1 \odot T_2) \odot (\{1\} \ominus T_2 \oplus T_1 \odot T_2),$$
$$(\{1\} \ominus I_1 \oplus I_1 \odot I_2) \odot (\{1\} \ominus I_2 \oplus I_1 \odot I_2),$$
$$(\{1\} \ominus F_1 \oplus F_1 \odot F_2) \odot (\{1\} \ominus F_2 \oplus F_1 \odot F_2)).$$

Neutrosophic Logic Connectors (cont'd)

7. Sheffer's connector:

$$NL(A_1 | A_2) = NL(\neg A_1 \vee \neg A_2) = (\{1\} \ominus T_1 \odot T_2, \{1\} \ominus I_1 \odot I_2, \{1\} \ominus F_1 \odot F_2).$$

8. Peirce's connector:

$$NL(A_1 \downarrow A_2) = NL(\neg A_1 \wedge \neg A_2) = \\ = ((\{1\} \ominus T_1) \odot (\{1\} \ominus T_2), (\{1\} \ominus I_1) \odot (\{1\} \ominus I_2), (\{1\} \ominus F_1) \odot (\{1\} \ominus F_2)).$$

Many properties of the classical logic operators do not apply in neutrosophic logic.

Neutrosophic logic operators (connectors) can be defined in many ways according to the needs of applications or of the problem solving.

Neutrosophic Set (NS)

- Let U be a universe of discourse, M a set included in U . An element x from U is noted with respect to the **neutrosophic set** M as $x(T, I, F)$ and belongs to M in the following way:

it is $t\%$ true in the set (*degree of membership*),

$i\%$ indeterminate (unknown if it is in the set) (*degree of indeterminacy*),

and $f\%$ false (*degree of non-membership*),

where t varies in T , i varies in I , f varies in F .

- Definition analogue to NL

- Generalizes the fuzzy set (FS), especially the intuitionistic fuzzy set (IFS), intuitionistic set (IS), paraconsistent set (PS)

- Example: $x(50,20,40)$ in A means: with a believe of 50% x is in A , with a believe of 40% x is not in A (disbelieve), and the 20% is undecidable

Neutrosophic Cube as geometric interpretation of the Neutrosophic Set

- The most important distinction between IFS and NS is showed in the below **Neutrosophic Cube** $A'B'C'D'E'F'G'H'$ introduced by J. Dezert in 2002.
- Because in technical applications only the classical interval is used as range for the neutrosophic parameters , we call the cube the **technical neutrosophic cube** and its extension the **neutrosophic cube** (or **absolute neutrosophic cube**), used in the fields where we need to differentiate between *absolute* and *relative* (as in philosophy) notions.

Neutrosophic Cube as geometric interpretation of the Neutrosophic Set (2)

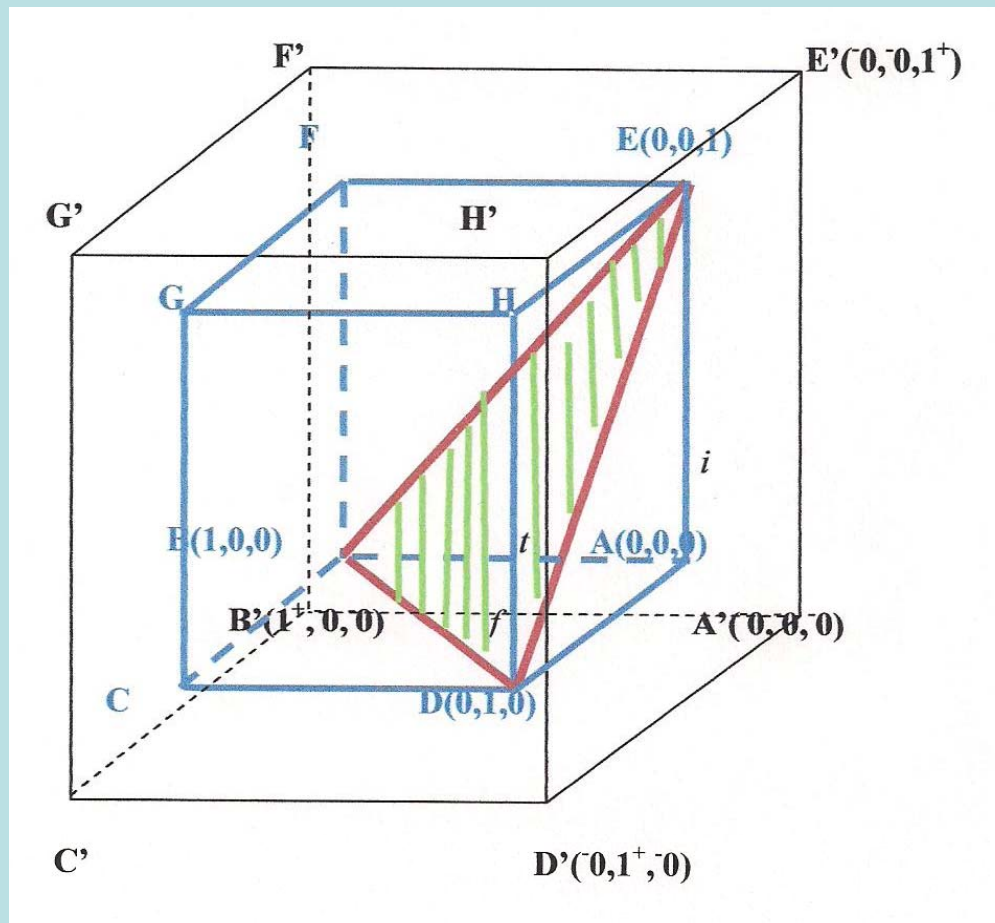

Neutrosophic Cube as geometric interpretation of the Neutrosophic Set (3)

Let's consider a 3D-Cartesian system of coordinates, where t is the truth axis with value range in $]0,1+[$, i is the false axis with value range in $]0,1+[$, and similarly f is the indeterminate axis with value range in $]0,1+[$.

We now divide the technical neutrosophic cube ABCDEFGH into three disjoint regions:

- 1) The equilateral triangle BDE, whose sides are equal to $\sqrt{2}$ which represents the geometrical locus of the points whose sum of the coordinates is 1.

If a point Q is situated on the sides of the triangle BDE or inside of it, then $t_Q + i_Q + f_Q = 1$ as in Atanassov-intuitionistic fuzzy set (A-IFS).

Neutrosophic Cube as geometric interpretation of the Neutrosophic Set (4)

- 2) The pyramid EABD {situated in the right side of the triangle EBD, including its faces triangle ABD(base), triangle EBA, and triangle EDA (lateral faces), but excluding its face: triangle BDE } is the locus of the points whose sum of coordinates is less than 1.
- 3) In the left side of triangle BDE in the cube there is the solid EFGCDEBD (excluding triangle BDE) which is the locus of points whose sum of their coordinates is greater than 1 as in the paraconsistent set.

Neutrosophic Cube as geometric interpretation of the Neutrosophic Set (5)

- It is possible to get the **sum of coordinates strictly less than 1 or strictly greater than 1**. For example:
- We have a source which is capable to find only the degree of membership of an element; but it is unable to find the degree of non-membership;
- Another source which is capable to find only the degree of non-membership of an element;
- Or a source which only computes the indeterminacy.
- Thus, when we put the results together of these sources, it is possible that their sum is not 1, but smaller or greater.

Neutrosophic Cube as geometric interpretation of the Neutrosophic Set (6)

- Also, in information fusion, when dealing with indeterminate models (i.e. elements of the fusion space which are indeterminate/unknown, such as intersections we don't know if they are empty or not since we don't have enough information, similarly for complements of indeterminate elements, etc.): if we compute the believe in that element (truth), the disbelieve in that element (falsehood), and the indeterminacy part of that element, then the sum of these three components is strictly less than 1 (the difference to 1 is the missing information).

Neutrosophic Set Operators

A and B two sets over the universe U.

An element $x(T_1, I_1, F_1)$ in A and $x(T_2, I_2, F_2)$ in B [*neutrosophic membership appartenance* to A and respectively to B]. NS operators (similar to NL connectors) can also be defined in many ways.

1. Complement of A:

If $x(T_1, I_1, F_1) \in A$,
then $x(\{1^+\} \ominus T_1, \{1^+\} \ominus I_1, \{1^+\} \ominus F_1) \in C(A)$.

2. Intersection:

If $x(T_1, I_1, F_1) \in A$, $x(T_2, I_2, F_2) \in B$,
then $x(T_1 \odot T_2, I_1 \odot I_2, F_1 \odot F_2) \in A \cap B$.

3. Union:

If $x(T_1, I_1, F_1) \in A$, $x(T_2, I_2, F_2) \in B$,
then $x(T_1 \oplus T_2 \ominus T_1 \odot T_2, I_1 \oplus I_2 \ominus I_1 \odot I_2, F_1 \oplus F_2 \ominus F_1 \odot F_2) \in A \cup B$.

4. Difference:

If $x(T_1, I_1, F_1) \in A$, $x(T_2, I_2, F_2) \in B$,
then $x(T_1 \ominus T_1 \odot T_2, I_1 \ominus I_1 \odot I_2, F_1 \ominus F_1 \odot F_2) \in A \setminus B$,
because $A \setminus B = A \cap C(B)$.

Differences between Neutrosophic Set and Intuitionistic Fuzzy Set

- In NS there is no restriction on T, I, F, while in IFS the sum of components (or their superior limits) = 1; thus NS can characterize the *incomplete information* (sum < 1), *paraconsistent information* (sum > 1).
- NS can distinguish, in philosophy, between *absolute membership* [NS(absolute membership)=1⁺] and *relative membership* [NS(relativemembership)=1], while IFS cannot; **absolute membership** is membership in all possible worlds, **relative membership** is membership in at least one world.
- In NS the components can be nonstandard, in IFS they don't.
- NS, like *dialetheism* [some contradictions are true], can deal with paradoxes, NS(paradox element) = (1,I,1), while IFS cannot.
- NS operators can be defined with respect to T,I,F while IFS operators are defined with respect to T and F only
- I can be split in NS in more subcomponents (for example in Belnap's four-valued logic (1977) indeterminacy is split into uncertainty and contradiction), but in IFS it cannot

Partial Order in Neutrosophics

We define a *partial order relationship* on the neutrosophic set/logic in the following way:

$x(T_1, I_1, F_1) \leq y(T_2, I_2, F_2)$ iff (if and only if)

$T_1 \leq T_2, I_1 \geq I_2, F_1 \geq F_2$ for crisp components.

And, in general, for subunitary set components:

$x(T_1, I_1, F_1) \leq y(T_2, I_2, F_2)$ iff

$\inf T_1 \leq \inf T_2, \sup T_1 \leq \sup T_2,$

$\inf I_1 \geq \inf I_2, \sup I_1 \geq \sup I_2,$

$\inf F_1 \geq \inf F_2, \sup F_1 \geq \sup F_2.$

Partial Order in Neutrosophics (2)

- If we have mixed - crisp and subunitary - components, or only crisp components, we can transform any crisp component, say “a” with a in $[0,1]$ or a in $]^{-0}, 1^{+}[$, into a subunitary set $[a, a]$. So, the definitions for subunitary set components should work in any case.

N-norm and N-Conorm

As a generalization of T-norm and T-conorm from the Fuzzy Logic and Set, we now introduce the N-norms and N-conorms for the Neutrosophic Logic and Set.

N-norm

$N_n: (]-0,1+[\times]-0,1+[\times]-0,1+[)^2 \rightarrow]-0,1+[\times]-0,1+[\times]-0,1+[$
 $N_n (x(T_1, I_1, F_1), y(T_2, I_2, F_2)) = (N_n T(x, y), N_n I(x, y), N_n F(x, y)),$
where $N_n T(...)$, $N_n I(...)$, $N_n F(...)$ are the truth/membership, indeterminacy, and respectively falsehood/nonmembership components.

N-norm (2)

N_n have to satisfy, for any x, y, z in the neutrosophic logic/set M of the universe of discourse U , the following axioms:

a) Boundary Conditions: $N_n(x, \mathbf{0}) = \mathbf{0}$, $N_n(x, \mathbf{1}) = x$.

b) Commutativity: $N_n(x, y) = N_n(y, x)$.

c) Monotonicity: If $x \leq y$, then $N_n(x, z) \leq N_n(y, z)$.

d) Associativity: $N_n(N_n(x, y), z) = N_n(x, N_n(y, z))$.

N-norm (3)

- There are cases when not all these axioms are satisfied, for example the associativity when dealing with the neutrosophic normalization after each neutrosophic operation. But, since we work with approximations, we can call these N-pseudo-norms, which still give good results in practice.
- N_n represent the *and* operator in neutrosophic logic, and respectively the *intersection* operator in neutrosophic set theory.

N-norm (4)

Let J in $\{T, I, F\}$ be a component.

Most known N-norms, as in fuzzy logic and set the T-norms, are:

- The Algebraic Product N-norm: $N_{n\text{-algebraic}}J(x, y) = x \cdot y$
- The Bounded N-Norm: $N_{n\text{-bounded}}J(x, y) = \max\{0, x + y - 1\}$
- The Default (min) N-norm: $N_{n\text{-min}}J(x, y) = \min\{x, y\}$.

N-norm (5)

A general example of N-norm would be this:

Let $x(T_1, I_1, F_1)$ and $y(T_2, I_2, F_2)$ be in the neutrosophic set/logic M . Then:

$$N_n(x, y) = (T_1 \wedge T_2, I_1 \vee I_2, F_1 \vee F_2)$$

where the “ \wedge ” operator, acting on two (standard or non-standard) subunitary sets, is a N-norm (verifying the above N-norms axioms); while the “ \vee ” operator, also acting on two (standard or non-standard) subunitary sets, is a N-conorm (verifying the below N-conorms axioms).

N-norm (6)

- For example, \wedge can be the Algebraic Product T-norm/N-norm, so $T_1 \wedge T_2 = T_1 \cdot T_2$ (herein we have a product of two subunitary sets – using simplified notation); and \vee can be the Algebraic Product T-conorm/N-conorm, so $T_1 \vee T_2 = T_1 + T_2 - T_1 \cdot T_2$ (herein we have a sum, then a product, and afterwards a subtraction of two subunitary sets).

N-conorm (7)

$$N_c: (]-0,1+[\times]-0,1+[\times]-0,1+[)^2 \rightarrow]-0,1+[\times]-0,1+[\times]-0,1+[$$

$$N_c (x(T_1, I_1, F_1), y(T_2, I_2, F_2)) = (N_c T(x, y), N_c I(x, y), N_c F(x, y)),$$

where $N_n T(\dots)$, $N_n I(\dots)$, $N_n F(\dots)$ are the truth/membership, indeterminacy, and respectively falsehood/nonmembership components.

N-conorm (8)

N_c have to satisfy, for any x, y, z in the neutrosophic logic/set M of universe of discourse U , the following axioms:

- a) Boundary Conditions: $N_c(x, 1) = 1, N_c(x, 0) = x$.
- b) Commutativity: $N_c(x, y) = N_c(y, x)$.
- c) Monotonicity: if $x \leq y$, then $N_c(x, z) \leq N_c(y, z)$.
- d) Associativity: $N_c(N_c(x, y), z) = N_c(x, N_c(y, z))$.

N-conorm (9)

- There are cases when not all these axioms are satisfied, for example the associativity when dealing with the neutrosophic normalization after each neutrosophic operation. But, since we work with approximations, we can call these N-pseudo-conorms, which still give good results in practice.
- N_c represent the *or* operator in neutrosophic logic, and respectively the *union* operator in neutrosophic set theory.

N-conorm (10)

Let J in $\{T, I, F\}$ be a component.

Most known N-conorms, as in fuzzy logic and set the T-conorms, are:

- The Algebraic Product N-conorm: $N_{c\text{-algebraic}}J(x, y) = x + y - x \cdot y$
- The Bounded N-conorm: $N_{c\text{-bounded}}J(x, y) = \min\{1, x + y\}$
- The Default (max) N-conorm: $N_{c\text{-max}}J(x, y) = \max\{x, y\}$.

N-conorm (11)

A general example of N-conorm would be this.

Let $x(T_1, I_1, F_1)$ and $y(T_2, I_2, F_2)$ be in the neutrosophic set/logic M . Then:

$$N_n(x, y) = (T_1 \vee T_2, I_1 \wedge I_2, F_1 \wedge F_2)$$

Where – as above - the “ \wedge ” operator, acting on two (standard or non-standard) subunitary sets, is a N-norm (verifying the above N-norms axioms); while the “ \vee ” operator, also acting on two (standard or non-standard) subunitary sets, is a N-conorm (verifying the above N-conorms axioms).

N-conorm (12)

For example, \wedge can be the Algebraic Product T-norm/N-norm, so $T_1 \wedge T_2 = T_1 \cdot T_2$ (herein we have a product of two subunitary sets); and \vee can be the Algebraic Product T-conorm/N-conorm, so $T_1 \vee T_2 = T_1 + T_2 - T_1 \cdot T_2$ (herein we have a sum, then a product, and afterwards a subtraction of two subunitary sets).

N-conorm (13)

Or \wedge can be any T-norm/N-norm, and \vee any T-conorm/N-conorm from the above; for example the easiest way would be to consider the *min* for crisp components (or *inf* for subset components) and respectively *max* for crisp components (or *sup* for subset components).

If we have crisp numbers, we can at the end neutrosophically normalize.

Interval Neutrosophic Operators

Interval Neutrosophic Conjunction/Intersection:

$$x \wedge y = (T_{\wedge}, I_{\wedge}, F_{\wedge}),$$

$$\text{where } \inf T_{\wedge} = \min\{\inf T_1, \inf T_2\}$$

$$\sup T_{\wedge} = \min\{\sup T_1, \sup T_2\}$$

$$\inf I_{\wedge} = \max\{\inf I_1, \inf I_2\}$$

$$\sup I_{\wedge} = \max\{\sup I_1, \sup I_2\}$$

$$\inf F_{\wedge} = \max\{\inf F_1, \inf F_2\}$$

$$\sup F_{\wedge} = \max\{\sup F_1, \sup F_2\}$$

Interval Neutrosophic Operators (2)

Interval Neutrosophic Disjunction/Union:

$$x \vee y = (T_V, I_V, F_V),$$

$$\text{where } \inf T_V = \max\{\inf T_1, \inf T_2\}$$

$$\sup T_V = \max\{\sup T_1, \sup T_2\}$$

$$\inf I_V = \min\{\inf I_1, \inf I_2\}$$

$$\sup I_V = \min\{\sup I_1, \sup I_2\}$$

$$\inf F_V = \min\{\inf F_1, \inf F_2\}$$

$$\sup F_V = \min\{\sup F_1, \sup F_2\}$$

Interval Neutrosophic Operators (3)

Interval Neutrosophic Containment:

We say that the neutrosophic set A is included in the neutrosophic set B of the universe of discourse U ,

iff for any $x(T_A, I_A, F_A) \in A$ with $x(T_B, I_B, F_B) \in B$ we have:

$$\inf T_A \leq \inf T_B ; \sup T_A \leq \sup T_B ;$$

$$\inf I_A \geq \inf I_B ; \sup I_A \geq \sup I_B ;$$

$$\inf F_A \geq \inf F_B ; \sup F_A \geq \sup F_B .$$

Remarks on Neutrosophic Operators

- A. The non-standard unit interval $]0, 1+[$ is merely used for philosophical applications, especially when we want to make a distinction between relative truth (truth in at least one world) and absolute truth (truth in all possible worlds), and similarly for distinction between relative or absolute falsehood, and between relative or absolute indeterminacy.

Remarks on Neutrosophic Operators (2)

But, for technical applications of neutrosophic logic and set, the domain of definition and range of the N-norm and N-conorm can be restrained to the normal standard real unit interval $[0, 1]$, which is easier to use, therefore:

$$N_n: ([0, 1] \times [0, 1] \times [0, 1])^2 \rightarrow [0, 1] \times [0, 1] \times [0, 1]$$

and

$$N_c: ([0, 1] \times [0, 1] \times [0, 1])^2 \rightarrow [0, 1] \times [0, 1] \times [0, 1].$$

Remarks on Neutrosophic Operators (3)

B. Since in NL and NS the sum of the components (in the case when T, I, F are crisp numbers, not sets) is not necessary equal to 1 (so the normalization is not required), we can keep the final result un-normalized.

But, if the normalization is needed for special applications, we can normalize at the end by dividing each component by the sum all components.

Remarks on Neutrosophic Operators (4)

C. If T, I, F are subsets of $[0, 1]$ the problem of neutrosophic normalization is more difficult.

If $\sup(T) + \sup(I) + \sup(F) < 1$, we have an *intuitionistic proposition/set*.

If $\inf(T) + \inf(I) + \inf(F) > 1$, we have a *paraconsistent proposition/set*.

If there exist the crisp numbers t in T , i in I , and f in F such that $t + i + f = 1$, then we can say that we have a *plausible normalized proposition/set*.

Examples of Neutrosophic Operators resulting from N-Norms or N-pseudonorms

The neutrosophic conjunction (intersection) operator component truth, indeterminacy, and falsehood values result from the multiplication

$$(T_1+I_1+F_1) \cdot (T_2+I_2+F_2)$$

since we consider in a prudent way $T < I < F$, where “<” is a neutrosophic relationship and means “weaker”, i.e. the products $T_i I_j$ will go to I , $T_i F_j$ will go to F , and $I_i F_j$ will go to F for all i, j in $\{1, 2\}$, while of course the product $T_1 \cdot T_2$ will go to T , $I_1 \cdot I_2$ will go to I , and $F_1 \cdot F_2$ will go to F (or reciprocally we can say that F prevails in front of I which prevails in front of T , and this neutrosophic relationship is transitive)

Application of Fuzzy Logic to Information Fusion

- Suppose we look for a target identification: is that a tank or not?
- Then $\Omega = \{\text{Tank, not Tank}\}$.
- Two fuzzy sources m_1 and m_2 give us information about the target:
 $m_1(\text{Tank}) = 0.4$, then $m_1(\text{not Tank}) = 0.6$;
 $m_2(\text{Tank}) = 0.5$, then $m_2(\text{not Tank}) = 0.5$.
- Then we use the product-sum fuzzy operators:
“and” for the truth component: $a \wedge b = ab$ (T-norm);
“or” for the false component: $a \vee b = a + b - ab$ (T-conorm):

$$(m_1 \wedge m_2)(\text{Tank}) = 0.4(0.5) = 0.2.$$

$$\text{Then, of course } (m_1 \vee m_2)(\text{not Tank}) = 1 - 0.2 = 0.8$$

{ or through a different calculation using the above T-conorm
 $(m_1 \vee m_2)(\text{not Tank}) = 0.6 + 0.5 - 0.6(0.5) = 0.8$ }.

T-norm is a class of “and” (conjunction/intersection) fuzzy operators,
while T-conorm is a class of “or” (disjunction/union) fuzzy operators.

Application of Neutrosophic Logic to Information Fusion

- Suppose we look for a target type identification: is the target a friend, a neutral, or an enemy?
- Then $\Omega = \{ F(\text{riend}), N(\text{eutral}), E(\text{nemy}) \}$.

- Two neutrosophic sources nm_1 and nm_2 give us information about the target type:

$$nm_1(F) = 0.2, nm_1(N) = 0.3, nm_1(E) = 0.5;$$

$$nm_2(F) = 0.6, nm_2(N) = 0.1, nm_2(E) = 0.3;$$

- Then we use the neutrosophic product operator “and” (N-norm):
 $(a_1, a_2, a_3) \wedge (b_1, b_2, b_3) = (a_1 b_1, a_2 b_2, a_3 b_3)$ and then normalize.

$$(nm_1 \wedge nm_2)(F, N, E) = (0.2 \cdot 0.6, 0.3 \cdot 0.1, 0.5 \cdot 0.3) = (0.12, 0.03, 0.15) \text{ and then divide by their sum } 0.30 \text{ (normalize):}$$

$$= (0.4, 0.1, 0.5)$$

So, it is mostly (with a believe of 50%) an Enemy target.

N-norm is a class of “and” (conjunction/intersection) neutrosophic operators, while N-conorm is a class of “or” (disjunction/union) neutrosophic operators.

- So, there are many “and”/”or” neutrosophic operators.

How to Compute with Labels

- **Type of sources of information:**
 - 1) **Numerical Source**, which gives us believe estimation in numbers.
Example: The likelihood that the aircraft is a Fighter is 80%.
 - 2) **Qualitative Source**, which gives us words (in natural language), also called labels.
Example: The likelihood that the aircraft is a Fighter is *high*.
- **How to Compute with Labels?**
 - Either try to convert the labels into approximate corresponding numbers in $[0,1]$;
 - Or, directly compute with labels.
- **Previous Example:** Then $\Omega = \{ F(\text{riend}), N(\text{eutral}), E(\text{nemy}) \}$.
Two qualitative neutrosophic sources nm_1 and nm_2 give us information about the target type:
 $qnm_1(F) = \text{very low}$, $qnm_1(N) = \text{above low}$, $qnm_1(E) = \text{medium}$;
 $qnm_2(F) = \text{above medium}$, $qnm_2(N) = \text{very low}$, $qnm_2(E) = \text{low}$;

How to Compute with Labels (2)

- The set of ordered labels is:

$L_{\min} < \text{Very Low} < \text{Low} < \text{Above Low} < \text{Medium} < \text{Above Medium} < \text{High} < \text{Very High} < L_{\max}$

But we can renumber them:

$L_0 = L_{\min} < L_1 < L_2 < L_3 < L_4 < L_5 < L_6 < L_7 < L_{\max}$

$$\begin{aligned} (qnm_1 \wedge qnm_2)(F, N, E) &= (L_1, L_3, L_4) \wedge (L_5, L_1, L_2) \\ &= (\min\{L_1, L_5\}, \min\{L_3, L_1\}, \min\{L_4, L_2\}) \end{aligned}$$

[amongst the neutrosophic “and” operators we have used the min operator]

$$= (L_1, L_1, L_2)$$

and we quasi-normalize the result by increasing with the same quality each label;

so we get $= (L_2, L_2, L_3)$

$$(qnm_1 \wedge qnm_2)(F, N, E) = (\text{low}, \text{low}, \text{above low}),$$

so the largest believe [= above low] is that the target is an Enemy.

General Applications of Neutrosophic Logic

Voting (pro, contra, neuter):

- The candidate C , who runs for election in a metropolis M of p people with right to vote, will win.

This proposition is, say, 20-25% true (percentage of people voting for him), 35-45% false (percentage of people voting against him), and 40% or 50% indeterminate (percentage of people not coming to the ballot box, or giving a blank vote - not selecting anyone, or giving a negative vote - cutting all candidates on the list).

Epistemic/subjective uncertainty (which has hidden/unknown parameters).

- Tomorrow it will rain.

This proposition is, say, 50% true according to meteorologists who have investigated the past years' weather, between 20-30% false according to today's very sunny and droughty summer, and 40% undecided.

Applications of Neutrosophic Logic (2)

Paradoxes:

- This is a heap (Sorites Paradox).
We may now say that this proposition is 80% true, 40% false, and 25-35% indeterminate (the neutrality comes for we don't know exactly where is the difference between a heap and a non-heap; and, if we approximate the border, our 'accuracy' is subjective). Vagueness plays here an important role.
- The Medieval paradox, called Buridan's Ass after Jean Buridan (near 1295-1356), is a perfect example of complete indeterminacy. An ass, equidistantly from two quantitatively and qualitatively heaps of grain, starves to death because there is no ground for preferring one heap to another.
The neutrosophic value of ass's decision, $NL = (0, 1, 0)$.

Games (win, defeated, tied).

Electrical charge, temperature, altitude, numbers, and other 3-valued systems (positive, negative, zero)

General Applications of Neutrosophic Logic (3)

Business (M. Khoshnevisan, S. Bhattacharya):

- Investors who are: Conservative and security-oriented (*risk shy*), Chance-oriented and progressive (*risk happy*), or Growth-oriented and dynamic (*risk neutral*).

General Applications of Neutrosophic Sets

Philosophical Applications:

- Or, how to calculate the truth-value of Zen (in Japanese) / Chan (in Chinese) doctrine philosophical proposition: the present is eternal and comprises in itself the past and the future?
- In Eastern Philosophy the contradictory utterances form the core of the Taoism and Zen/Chan (which emerged from Buddhism and Taoism) doctrines.
- How to judge the truth-value of a metaphor, or of an ambiguous statement, or of a social phenomenon which is positive from a standpoint and negative from another standpoint?

Physics Applications:

- How to describe a particle ξ in the infinite micro-universe of Quantum Physics that belongs to two distinct places P_1 and P_2 in the same time? ξ in P_1 and ξ is not in P_1 as a true contradiction, or ξ in P_1 and ξ in $\text{non}P_1$.

General Applications of Neutrosophic Sets (2)

- Don't we better describe, using the attribute "neutrosophic" than "fuzzy" and others, a quantum particle that neither exists nor non-exists? [high degree of indeterminacy]
- In Schroedinger's Equation on the behavior of electromagnetic waves and "matter waves" in Quantum Theory, the wave function Ψ which describes the superposition of possible states may be simulated by a neutrosophic function, i.e. a function whose values are not unique for each argument from the domain of definition (the vertical line test fails, intersecting the graph in more points).
- A cloud is a neutrosophic set, because its borders are ambiguous, and each element (water drop) belongs with a neutrosophic probability to the set (e.g. there are a kind of separated water drops, around a compact mass of water drops, that we don't know how to consider them: in or out of the cloud).

Neutrosophic Numbers

- The **Neutrosophic Numbers** have been introduced by W.B. Vasantha Kandasamy and F. Smarandache, which are numbers of the form $N = a + bI$, where a, b are real or complex numbers, while “ I ” is the indeterminacy part of the neutrosophic number N , such that $I^2 = I$ and $\alpha I + \beta I = (\alpha + \beta)I$.
- Of course, indeterminacy “ I ” is different from the imaginary number i .
- In general one has $I^n = I$ if $n > 0$, and is undefined if $n \leq 0$.

Neutrosophic Algebraic Structures

- The algebraic structures using neutrosophic numbers gave birth to the **neutrosophic algebraic structures** [see for example “neutrosophic groups”, “neutrosophic rings”, “neutrosophic vector space”, “neutrosophic matrices, bimatrices, ..., n-matrices”, etc.], introduced by W.B. Vasantha Kandasamy, F. Smarandache *et al.*

- Example of Neutrosophic Ring:

$(\{a+bl, \text{ with } a, b \in R\}, +, \cdot)$, where of course
 $(a+bl)+(c+dl) = (a+c)+(b+d)l$, and $(a+bl) \cdot (c+dl)$
 $= (ac) + (ad+bc+bd)l$.

Neutrosophic Matrix

- A Neutrosophic Matrix is a matrix which has neutrosophic numbers.

See an example:

$$\begin{bmatrix} 1 & 2 + I & -5 \\ 0 & 1/3 & I \\ -1 + 4I & 6 & 5I \end{bmatrix}$$

Neutrosophic Graphs and Trees

- Also, “I” led to the definition of the **neutrosophic graphs** (graphs which have at least either one indeterminate edge or one indeterminate node), and **neutrosophic trees** (trees which have at least either one indeterminate edge or one indeterminate node), which have many applications in social sciences.

Neutrosophic Graphs and Trees (2)

- An edge is said indeterminate if we don't know if it is any relationship between the nodes it connects, or for a directed graph we don't know if it is a directly or inversely proportional relationship.
- A node is indeterminate if we don't know what kind of node it is since we have incomplete information.

Neutrosophic Graphs and Trees (3)

- Example of Neutrosophic Graph (edges V_1V_3 , V_1V_5 , V_2V_3 are indeterminate and they are drawn as dotted):

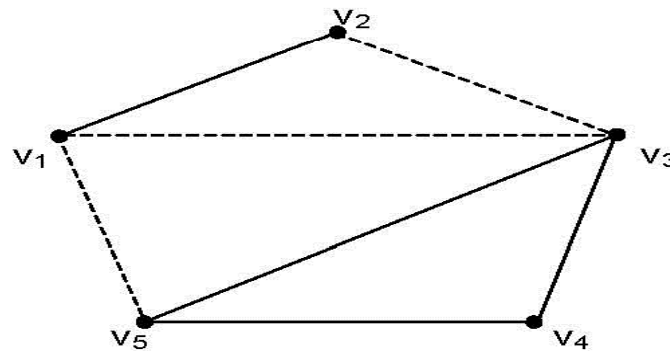

Neutrosophic Graphs and Trees (4)

The graph's neutrosophic adjacency matrix is below.

The edges mean: 0 = no connection between nodes, 1 = connection between nodes, I = indeterminate connection (not known if it is or if it is not).

Such notions are not used in the fuzzy theory.

$$\begin{bmatrix} 0 & 1 & I & 0 & I \\ 1 & 0 & I & 0 & 0 \\ I & I & 0 & 1 & 1 \\ 0 & 0 & 1 & 0 & 1 \\ I & 0 & 1 & 1 & 0 \end{bmatrix}$$

Neutrosophic Cognitive Maps & Neutrosophic Relational Maps

- As a consequence, the neutrosophic cognitive maps and neutrosophic relational maps are generalizations of fuzzy cognitive maps and respectively fuzzy relational maps (W.B. Vasantha Kandasamy, F. Smarandache *et al.*).
- A **Neutrosophic Cognitive Map** (NCM) is a neutrosophic directed graph with concepts like policies, events etc. as nodes and causalities or indeterminates as edges. It represents the causal relationship between concepts.

Neutrosophic Cognitive Maps & Neutrosophic Relational Maps (2)

- Example of Neutrosophic Cognitive Map (NCM), which is a generalization of the Fuzzy Cognitive Maps (FCM).
- Let's have the following nodes:
 - C1 - Child Labor
 - C2 - Political Leaders
 - C3 - Good Teachers
 - C4 - Poverty
 - C5 - Industrialists
 - C6 - Public practicing/encouraging Child Labor
 - C7 - Good Non-Governmental Organizations (NGOs)

Neutrosophic Cognitive Maps & Neutrosophic Relational Maps (3)

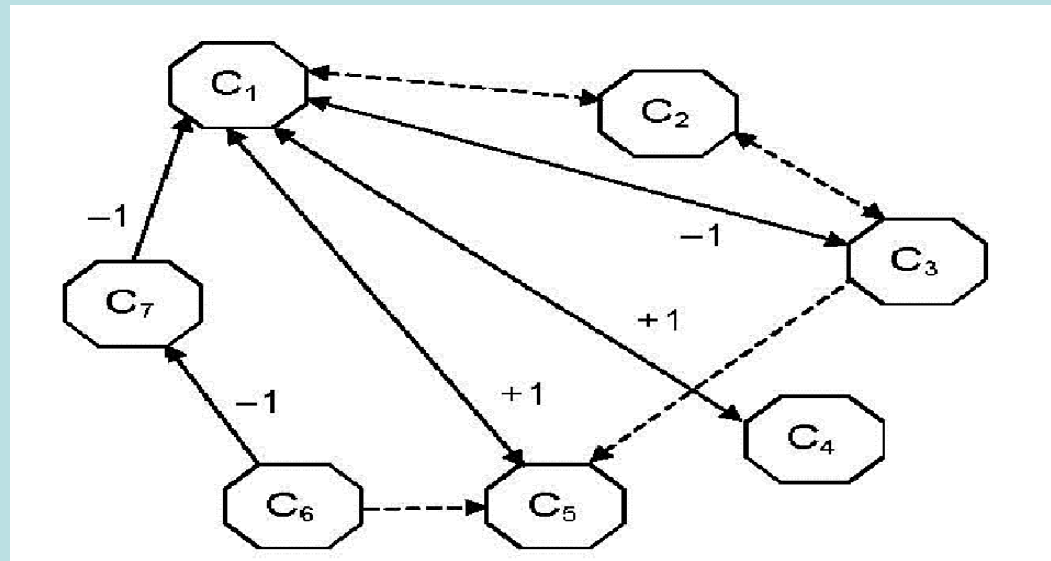

The edges mean: 0 = no connection between nodes, 1 = directly proportional connection, -1 = inversely proportionally connection, and I = indeterminate connection (not knowing what kind of relationship is between the nodes the edge connects).

Neutrosophic Cognitive Maps & Neutrosophic Relational Maps (4)

- The corresponding neutrosophic adjacency matrix related to this neutrosophic cognitive map is below.

$$\begin{bmatrix} 0 & I & -1 & 1 & 1 & 0 & 0 \\ I & 0 & I & 0 & 0 & 0 & 0 \\ -1 & I & 0 & 0 & I & 0 & 0 \\ 1 & 0 & 0 & 0 & 0 & 0 & 0 \\ 1 & 0 & 0 & 0 & 0 & 0 & 0 \\ 0 & 0 & 0 & 0 & I & 0 & -1 \\ -1 & 0 & 0 & 0 & 0 & 0 & 0 \end{bmatrix}$$

Neutrosophic Probability & Statistics

The neutrosophics introduced (in 1995) the Neutrosophic Probability (NP), which is a generalization of the classical and imprecise probabilities.

Neutrosophic Probability of an event E is the chance that event E occurs, the chance that event E doesn't occur, and the chance of indeterminacy (not knowing if the event E occurs or not).

Neutrosophic Probability & Statistics (2)

- In classical probability $n_{\text{sup}} \leq 1$, while in neutrosophic probability $n_{\text{sup}} \leq 3^+$.
- In imprecise probability: the probability of an event is a subset T in $[0, 1]$, not a crisp number p in $[0, 1]$, what's left is supposed to be the opposite, subset F (also from the unit interval $[0, 1]$); there is no indeterminate subset I in imprecise probability.
- And consequently the **Neutrosophic Statistics**, which is the analysis of the neutrosophic events.
- Neutrosophic statistics deals with neutrosophic numbers, neutrosophic probability distribution, neutrosophic estimation, neutrosophic regression.

Neutrosophic Probability & Statistics (3)

- The function that models the neutrosophic probability of a random variable x is called *neutrosophic distribution*:

$$NP(x) = (T(x), I(x), F(x)),$$

where $T(x)$ represents the probability that value x occurs, $F(x)$ represents the probability that value x does not occur, and $I(x)$ represents the indeterminate / unknown probability of value x .

Applications of Neutrosophy to Extenics and Indian Philosophy

- **Extenics**, founded by Prof. Cai Wen in 1983, means solving contradictions problems in information fusion, management, design, automation etc. using computers and Internet.
- In India's VIII-th - IX-th centuries one promulgated the **Non-Duality** (*Advaita*) through the non-differentiation between Individual Being (*Atman*) and Supreme Being (*Brahman*). The philosopher Sañkaracharya (782-814 A.C.) was then considered the savior of Hinduism, just in the moment when the Buddhism and the Jainism were in a severe turmoil and India was in a spiritual crisis. Non-Duality means elimination of ego, in order to blend yourself with the Supreme Being (to reach the happiness).
- Or, arriving to the Supreme was done by Prayer (*Bhakti*) or Cognition (*Jnana*). It is a part of Sañkaracharya's huge merit (*charya* means teacher) the originality of interpreting and synthesizing the Source of Cognition (Vedas, IV th century B.C.), the Epic (with many stories), and the *Upanishads* (principles of Hindu philosophy) concluding in Non-Duality.
- Then **Special Duality** (*Visishta Advaita*) follows, which asserts that Individual Being and Supreme Being are different in the beginning, but end to blend themselves (Rāmānujacharya, XI-th century).
- And later, to see that the neutrosophic scheme perfectly functions, **Duality** (*Dvaita*) ensues, through whom the Individual Being and Supreme Being were differentiated (Madhvacharya, XIII-th - XIV-th centuries).
- Thus: Non-Duality converged to Duality, i.e. <NonA> converges through⁷⁸ <NeutA> to <A>.

Neutrosophics as a situation analysis tool (1)

- In situation analysis (SA), an agent observing a scene receives information from heterogeneous sources of information including for example remote sensing devices, human reports and databases. The aim of this agent is to reach a certain awareness about the situation in order to take decisions
- Considering the logical connection between belief and knowledge, the challenge for the designer is to transform the raw, imprecise, conflicting and often paradoxical information received from the different sources into statements understandable by both man and machines
- Hence, two levels of processing coexist in SA: measuring of the world and reasoning about the world. Another great challenge in SA is the reconciliation of both aspects. As a consequence, SA applications need frameworks general enough to take into account the different types of uncertainty observed in the SA context, coupled with a semantics allowing reasoning on those situations

(Jousselme and Maupin, 2004)

Neutrosophics as a situation analysis tool (2)

- A particularity of SA is that most of the time it is impossible to list every possible situation that can occur. Corresponding frames of discernment cannot, thus, be considered as exhaustive
- Furthermore, in SA situations are not clear-cut elements of the frames of discernment. Considering these particular aspects of SA, a neutrosophic logic paradigm incorporating the *Dezert-Smarandache Theory* (DSmT) appears as an appropriate modeling tool
- It has been recently shown that the neutrosophic logic paradigm does have the capacity to cope with the epistemic and uncertainty-related problems of SA
- In particular, it has been formally demonstrated that the neutrosophic logic paradigm incorporating DSmT has the ability to process symbolic and numerical statements on belief and knowledge using the *possible worlds* semantics

(Jousselme and Maupin, 2004)

Neutrosophics as a Situation Analysis Tool (3)

- A **Kripke Model** $M_K = (S, \pi, R)$ is a *directed labeled graph*. The graph's nodes are the possible worlds s belonging to a set S of possible worlds, labeled by truth assignments π .

A world s is considered *possible with respect to another world s'* whenever there is an *edge linking s and s'* . This link is defined by an arbitrary binary relation, technically called the *accessibility relation* R .

A proposition φ is **known** if it is TRUE in all possible worlds of S .

A proposition φ is **believed** if it is TRUE in at least one possible world s of S .

- A **Neutrosophic Kripke Model**, extends Kripke structure in order to take into account triplets of truth assignments π (not only Boolean assignments).

The concepts of knowledge and believe are represented with hyperreal values (truth, falsity, indeterminacy) assignments on possible worlds.

$NL(\varphi) = (1^+, 0, 0)$ if φ is known (i.e. true in all possible worlds - absolute truth), and $NL(\varphi) = (1, 0, 0)$ if φ is believed (i.e. true in at least one world].

- While in a Kripke Model a proposition φ can only be TRUE or FALSE, in a Neutrosophic Kripke Model φ is allowed to be $T\%$ TRUE and $F\%$ FALSE, and $I\%$ INDETERMINATE, where T, I, F are hyperreal subsets of $]0, 1^+[$.

Application to Robotics

- For the fusion of information received from various sensors, information that can be conflicting in a certain degree, the robot uses the fuzzy and neutrosophic logic or set.
- In a real time it is used a neutrosophic dynamic fusion, so an autonomous robot can take a decision at any moment.

The Need for a Novel Decision Paradigm in Management - I

- The process of scientific decision-making necessarily follows an *input-output system*
- The primary input is in the form of raw data (quantitative, qualitative or both)
- This raw data is subsequently “cleaned”, “filtered” and “organized” to yield information
- The available information is then processed according to either (a) very well-structured, “hard” rules or (b) partially-structured “semi-soft” rules or (c) almost completely unstructured “soft” rules
- The output is the final decision which may be a relatively simple and routine one such as deciding on an optimal inventory re-ordering level or a much more complex and involved one such as discontinuing a product line or establishing a new *strategic business unit* (SBU). It has been observed that most of these complex and involved decision problems are those that need to be worked out using the “soft” rules of information processing

The Need for a Novel Decision Paradigm in Management - II

- Besides being largely subjective, “soft” decision rules are often ambiguous, inconsistent and even contradictory
- The main reason is that the event spaces governing complex decision problems are not completely known. However, the human mind abhors incompleteness when it comes to complex cognitive processing. The mind invariably tries to “fill in the blanks” whenever it encounters incompleteness
- Therefore, when different people form their own opinions from a given set of incomplete information, it is only to be expected that there will be areas of inconsistency, because everybody will try to “complete the set” in their own individual ways, governed by their own subjective utility preferences

The Need for a Novel Decision Paradigm in Management - III

- Looking at the following temporal trajectory of the market price of a share in ABC Corp. over the past thirty days, would it be considered advisable to invest in this asset?
- The “hard” decision rule applicable in this case is that “one should buy an asset when its price is going up and one should sell an asset when its price is going down”

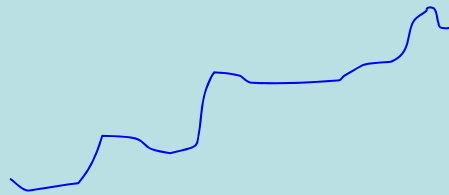

- The share price as shown above, is definitely trending in a particular direction. But will the observed trend over the past thirty days continue in the future? It is really very hard to say because most financial analysts will find this information rather inadequate to arrive at an informed judgment
- Although this illustration is purely anecdotal, it is nevertheless a matter of fact that the world of managerial decision-making is fraught with such inadequacies and “complete information” is often an unaffordable luxury

The Need for a Novel Decision Paradigm in Management - IV

- The more statistically minded decision-takers would try to forecast the future direction of the price trend of a share in ABC Corp. from the given (historical) information
- The implied logic is that the more accurate this forecast the more profitable will be the outcome resulting from the decision
- Let us take two financial analysts Mr. X and Ms. Y trying to forecast the price of a share in ABC Corp. To fit their respective trendlines, Mr. X considers the entire thirty days of data while Ms. Y (who knows about Markovian property of stock prices) considers only the price movement over a single day

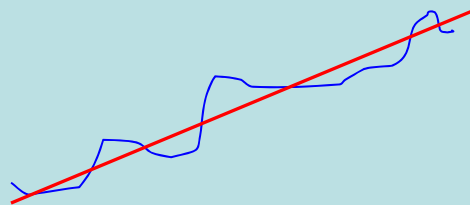

Mr. X's forecast trend

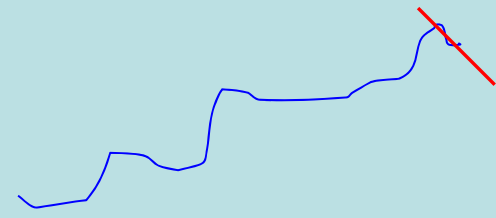

Ms. Y's forecast trend

- Who do you think is more likely to make the greater profit? (Please try answering the question before moving on to the next slide!)

The Need for a Novel Decision Paradigm in Management - V

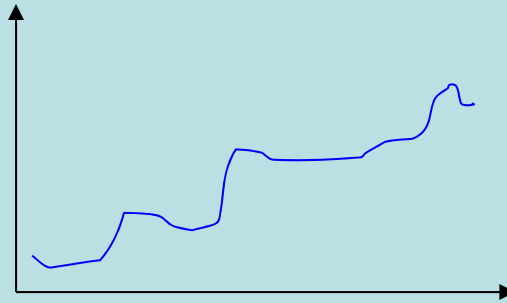

- Most people will have formed their opinions after having made a spontaneous assumption about the orientation of the coordinate axes i.e. the temporal order of the price data! This is an example of how our minds sub-consciously complete an “incomplete set” of information prior to cognitive processing!
- Obviously, without a definite knowledge about the orientation of the axes it is impossible to tell who is more likely to make a greater profit. This has nothing to do with which one of Mr. X or Ms. Y has the better forecasting model. In fact it is a somewhat *paradoxical* situation - we may know who among Mr. X and Ms. Y has a technically better forecasting model and yet don't know who will make more profit! That will remain *indeterminate* as long as the exact orientation of the two coordinate axes is unknown!

The Need for a Novel Decision Paradigm in Management - VI

- The neutrosophic probability approach makes a distinction between “relative sure event”, event that is true only in certain world(s) and “absolute sure event”, event that is true for all possible world(s)
- Similar relations can be drawn for “relative impossible event” / “absolute impossible event” and “relative indeterminate event” / “absolute indeterminate event”
- In case where the truth- and falsity-components are complimentary i.e. they sum up to unity and there is no indeterminacy, then it is reduced to classical probability. Therefore, neutrosophic probability may be viewed as a *three-way generalization* of classical and imprecise probabilities

The Need for a Novel Decision Paradigm in Management - VII

- In our little anecdotal illustration, we may visualize a world where stock prices follow a Markovian path and Ms. Y knows the correct orientation of the coordinate axes. That Ms. Y will make a greater profit thereby becomes a *relative sure event* and that Mr. X will make a greater profit becomes a *relative impossible event*.
- Similarly we may visualize a different world where stock prices follow a linear path and Mr. X knows the correct orientation of the coordinate axes. That Mr. X will make a greater profit thereby becomes a *relative sure event* and that Ms. Y will make a greater profit thereby becomes a *relative impossible event*.
- Then there is our present world where we have no knowledge at all as to the correct orientation of the coordinate axes and hence both thereby become relative indeterminate events!
- Because real-life managers have to mostly settle for “incomplete sets” of information, the arena of managerial decision-making is replete with such instances of paradoxes and inconsistencies. This is where neutrosophy can play a very significant role as a novel addition to the managerial decision paradigm!

Application of Neutrosophics in Production Facility Layout Planning and Design - I

- The original CRAFT (Computerized Relative Allocation of Facilities Technique) model for cost-optimal relative allocation of production facilities as well as many of its later extensions tend to be quite “heavy” in terms of CPU engagement time due to their heuristic nature
- A Modified Assignment (MASS) model (first proposed by Bhattacharya and Khoshnevisan in 2003) increases the computational efficiency by developing the facility layout problem as primarily a *Hungarian assignment* problem but becomes indistinguishable from the earlier CRAFT-type models beyond the initial configuration

Application of Neutrosophics in Production Facility Layout Planning and Design - II

- However, some amount of introspection will reveal that the production facilities layout problem is basically one of achieving *best interconnectivity by optimal fusion of spatial information*. In that sense, the problem may be better modeled in terms of mathematical information theory whereby *the best layout is obtainable as the one that maximizes relative entropy (or equivalently, minimizes relative negentropy) of the spatial configuration*
- Going a step further, one may hypothesize a neutrosophic dimension to the problem. Given a combination rule like the *Dezert-Smarandache formula*, the layout optimization problem may be formulated as a *normalized basic probability assignment* for optimally comparing between several alternative interconnectivities

Application of Neutrosophics in Production Facility Layout Planning and Design - III

- The neutrosophic argument can be justified by considering the very practical possibility of conflicting bodies of evidence for the structure of the load matrix possibly due to conflicting assessments of two or more design engineers
- If for example we consider two mutually conflicting bodies of evidence Ξ_1 and Ξ_2 , characterized respectively by their basic probability assignments μ_1 and μ_2 and their cores $k(\mu_1)$ and $k(\mu_2)$ then one has to look for the optimal combination rule which maximizes the joint entropy of the two conflicting information sources
- Mathematically, it boils down to the general optimization problem of evaluating $\max_{\mu} [H(\mu)] \equiv -\min_{\mu} [-H(\mu)]$ subject to the constraints that (a) the marginal basic probability assignments $\mu_1(\cdot)$ and $\mu_2(\cdot)$ are obtainable by the summation over each column and summation over each row respectively of the relevant information matrix and (b) the sum of all cells of the information matrix is unity

Applications to Neutrosophic and Paradoxist Physics

- **Neutrosophic Physics.**

- Let $\langle A \rangle$ be a physical entity (i.e. concept, notion, object, space, field, idea, law, property, state, attribute, theorem, theory, etc.), $\langle \text{anti}A \rangle$ be the opposite of $\langle A \rangle$, and $\langle \text{neut}A \rangle$ be their neutral (i.e. neither $\langle A \rangle$ nor $\langle \text{anti}A \rangle$, but in between).
- Neutrosophic Physics is a mixture of two or three of these entities $\langle A \rangle$, $\langle \text{anti}A \rangle$, and $\langle \text{neut}A \rangle$ that hold together.
- Therefore, we can have neutrosophic fields, and neutrosophic objects, neutrosophic states, etc.

- **Paradoxist Physics.**

- Neutrosophic Physics is an extension of Paradoxist Physics, since Paradoxist Physics is a combination of physical contradictories $\langle A \rangle$ and $\langle \text{anti}A \rangle$ only that hold together, without referring to their neutrality $\langle \text{neut}A \rangle$.

-

Applications to Neutrosophic and Paradoxist Physics (2)

- Paradoxist Physics describes collections of objects or states that are individually characterized by contradictory properties, or are characterized neither by a property nor by the opposite of that property, or are composed of contradictory sub-elements. Such objects or states are called *paradoxist entities*.
- **Several examples of paradoxist and neutrosophic entities.**

There are many cases in the scientific (and also in humanistic) fields that two or three of these items <A>, <antiA>, and <neutA> simultaneously coexist:
- - anions in two spatial dimensions are arbitrary spin particles that are neither bosons (integer spin) nor fermions (half integer spin);
- - among possible Dark Matter candidates there may be exotic particles that are neither Dirac nor Majorana fermions;
- - mercury (Hg) is a state that is neither liquid nor solid under normal conditions at room temperature;
- - non-magnetic materials are neither ferromagnetic nor anti-ferromagnetic;

Applications to Neutrosophic and Paradoxist Physics (3)

- - quark gluon plasma (QGP) is a phase formed by quasi-free quarks and gluons that behaves neither like a conventional plasma nor as an ordinary liquid;
- - unmatter, which is formed by matter and antimatter that bind together (Smarandache, 2004);
- - neutral kaon, which is a pion & anti-pion composite (Santilli, 1978) and thus a form of unmatter;
- - neutrosophic methods in General Relativity (Rabounski-Smarandache-Borissova, 2005);
- - neutrosophic cosmological model (Rabounski-Borissova, 2011);
- - neutrosophic gravitation (Rabounski);
- - neutrino-photon doublet (Goldfain);
- - semiconductors are neither conductors nor isolators;
- - semi-transparent optical components are neither opaque nor perfectly transparent to light;

Applications to Neutrosophic and Paradoxist Physics (4)

- - quantum states are metastable (neither perfectly stable, nor unstable);
- - In Quantum Field Theory the observables (i.e. the physical characteristics that can be measured in the laboratory) are represented by operators. For example, the Hamiltonian of a quantum electric oscillator determines the energy and it can be expressed as a function of the operators of creation and annihilation of oscillation quanta;
- - This idea of unparticle was first considered by F. Smarandache in 2004, 2005 and 2006, when he uploaded a paper on CERN web site and published three papers about what he called 'unmatter', which is a new form of matter formed by matter and antimatter that bind together. In 2006 E. Goldfain introduced the concept of "fractional number of field quanta" and he conjectured that these exotic phases of matter may emerge in the near or deep ultraviolet sector of quantum field theory. H. Georgi proposed the theory of unparticle physics in 2007 that conjectures matter that cannot be explained in terms of particles using the Standard Model of particle physics, because its components are scale invariant.

Etc.

Applications to Neutrosophic and Paradoxist Physics (5)

- - qubit and generally quantum superposition of states;
- - the “multiplet” of elementary particles is a kind of ‘neutrosophic field’ with two or more values (Ervin Goldfain, 2011);
- A **neutrosophic field** can be generalized to that of operators whose action is selective. The effect of the neutrosophic field is somehow equivalent with the “tunneling” from the solid physics, or with the “spontaneous symmetry breaking” (SSB) where there is an internal symmetry which is broken by a particular selection of the vacuum state (Ervin Goldfain).

More Applications

Neutrosophy and Neutrosophic Logic/Set/Probability/Statistics are used in:

- Extenics (to resolve contradictory problems);
- Description Logic, Relational Data Model, Semantic Web Service Agent;
- Image Segmentation;
- Remedy for Effective Cure of Diseases using Combined Neutrosophic Relational Maps;
- Neutrosophic Research Method;
- Transdisciplinarity, Multispace & Multistructure;
- Qualitative Causal Reasoning on Complex Systems;
- Study on suicide problem using combined overlap block Neutrosophic Cognitive Maps;
- Neutrosophic Topologies;

More Applications (2)

- Discrimination of outer membrane proteins using reformulated support vector machine based on neutrosophic set;
- Decision support tool for knowledge based institution using neutrosophic cognitive maps;
- Imprecise query solving;
- Answering queries in Relational Database using Neutrosophic Logia;
- Ensemble Neural Networks Using Interval Neutrosophic Sets and Bagging;
- Lithofacies Classification from Well Log Data using Neural Networks, Interval Neutrosophic Sets and Quantification of Uncertainty;
- Redesigning Decision Matrix Method with an indeterminacy-based inference process;
- Neural network ensembles using interval neutrosophic sets and bagging for mineral prospectivity prediction and quantification of uncertainty;

More Applications (3)

- Processing Uncertainty and Indeterminacy in Information Systems success mapping;
- Combination of Paradoxical, Uncertain, and Imprecise Sources of Information based on DSmT and Neutro-Fuzzy Inference;
- Neutrosophic Cognitive Maps in context of knowledge-based organizations.

Etc.

Webside

**Download books, articles, Ph D theses
on NEUTROSOPHICS from:**

<http://fs.gallup.unm.edu/neutrosophy.htm>